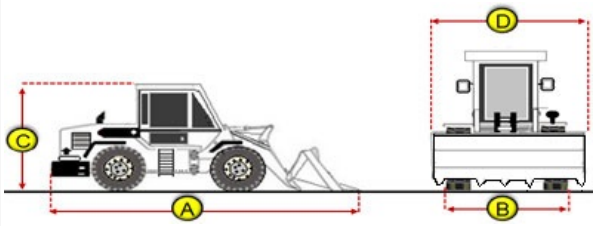

Inspection Report (Wheel Loader)

General Info

Year	2013
Make	CAT
Model	924K
Serial Number	PWR01937
Hour Meter Reading	17,642
Previous Application (e.g., earth moving, mining, demolition, etc)	General Construction

Dimensions

Measurement Guide	
A. Length (ft and inches)	24'2"
B. Width (ft and inches)	8'4"
C. Height (ft and inches)	10'11"
D. Attachment Width (ft and inches)	8'4"
Operational Weight (lbs)	28,360 LBS.



Features and Configuration

Control Station Type	Cab
Bucket	Yes
Bucket Specs	GP Bucket on machine / 2 other buckets available to swap out at customer's request
Auxiliary Hydraulics	Yes
Heat	Yes
A/C	Yes
Radio	No
Backup Camera	Yes
OMM (Operator & Maintenance Manual)	No
Telematics	No
Other Configuration Details / Notes	Customer has two additional grapple buckets that fit this machine. He is willing to remove the bucket currently on the machine in exchange for one of the two grapple buckets shown in pictures.

Exterior 360 Walkaround

Exterior 360 Walkaround

Inspection Report (Wheel Loader)

<p>Instructions</p>	<p>Take photos of the exterior of the piece of equipment. Capture a full 360 degree walk around and all major components.</p> <p>Must have shots to capture:</p> <ul style="list-style-type: none"> - Front - 45 degree corner shot of left front - 45 degree corner shot of right front - Left side - Right side - Rear - 45 degree corner shot of left rear - 45 degree corner shot of right rear <p>Tips for good photos:</p> <ul style="list-style-type: none"> - Move the equipment into a open area without any visual distractions or other equipment in the background
<p>Exterior Walkaround Photos</p>	
	

Inspection Report (Wheel Loader)



Inspection Report (Wheel Loader)





General Appearance Inspection Points

General Appearance

Front	4 - Like New, Recently Replaced
Front Condition	No visible damage



Inspection Report (Wheel Loader)

<p>Front Photos</p>	
	
<p>Rear</p>	<p>4 - Like New, Recently Replaced</p>
<p>Rear Condition</p>	<p>No visible damage</p>
<p>Rear Photos</p>	

Inspection Report (Wheel Loader)



Inspection Report (Wheel Loader)

		
Left	4 - Like New, Recently Replaced	
Left Condition	No visible damage	
Left Photos		
		



Inspection Report (Wheel Loader)



Inspection Report (Wheel Loader)



Inspection Report (Wheel Loader)

		
<p>Right</p>	<p>4 - Like New, Recently Replaced</p>	
<p>Right Condition</p>	<p>No visible damage</p>	
<p>Right Photos</p>		
		

Inspection Report (Wheel Loader)





Inspection Report (Wheel Loader)



Inspection Report (Wheel Loader)



Inspection Report (Wheel Loader)

	
	
	
<p>Upper</p>	<p>3 - Normal Wear & Tear</p>
<p>Upper Condition</p>	<p>No visible damage</p>

Inspection Report (Wheel Loader)

Upper Photos





Inspection Report (Wheel Loader)





Inspection Report (Wheel Loader)





Inspection Report (Wheel Loader)

	
Body Panels (Any Rust Damage?)	3 - Normal Wear & Tear
Doors / Canopy Latches	3 - Normal Wear & Tear
Doors / Canopy Latches Condition	No visible damage
Doors / Canopy Latches Photos	
	
Steps / Ladders	3 - Normal Wear & Tear
Steps / Ladders Condition	Steps/ladders are fully intact and appear structurally sound

Inspection Report (Wheel Loader)

<p>Steps / Ladders Photos</p>	
	
<p>Handrails</p>	<p>3 - Normal Wear & Tear</p>
<p>Handrails Condition</p>	<p>Handrails are fully intact and appear structurally sound</p>
<p>Handrail Photos</p>	

Inspection Report (Wheel Loader)

	
	
	
Glass Condition	3 - Normal Wear & Tear
Glass Condition Notes	Glass intact, no visible damage

Inspection Report (Wheel Loader)

Glass Condition Photos



Inspection Report (Wheel Loader)



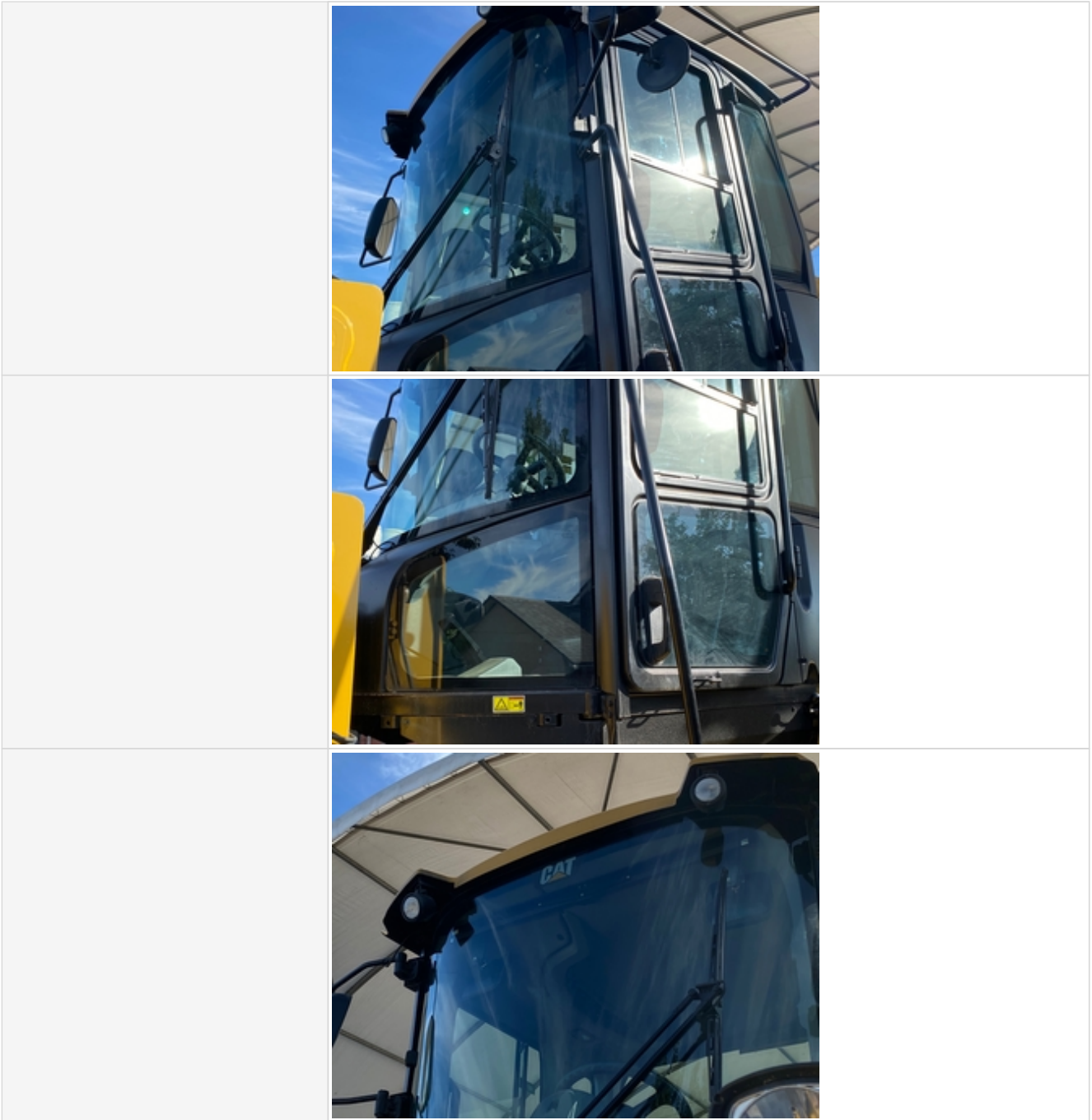

Inspection Report (Wheel Loader)





Inspection Report (Wheel Loader)



Inspection Report (Wheel Loader)

		
Mirrors	3 - Normal Wear & Tear	
Mirror Condition Notes	Mirrors present and intact, no visible damage	
Mirrors Photos		
		

Inspection Report (Wheel Loader)

	
	
	
Lighting System	3 - Normal Wear & Tear
Lighting System Condition	No visible damage, lighting system is operational

Inspection Report (Wheel Loader)

Lighting System Photos



Inspection Report (Wheel Loader)



Control Station Inspection Points

Control Station

Operator Cabin Overall	3 - Normal Wear & Tear
Operator Cabin Overall Condition	Good cabin appearance, solid floors, panels, and ceiling
Operator Cabin Photos	

Inspection Report (Wheel Loader)



Inspection Report (Wheel Loader)



Inspection Report (Wheel Loader)



Inspection Report (Wheel Loader)



Inspection Report (Wheel Loader)



Inspection Report (Wheel Loader)



Inspection Report (Wheel Loader)





Inspection Report (Wheel Loader)



Inspection Report (Wheel Loader)



Inspection Report (Wheel Loader)

	
Operator's Seat & Arm Rests	3 - Normal Wear & Tear
Operator's Seat & Arm Rests Condition	Seat(s) in good condition, no stains or tears in upholstery
Operator's Seat & Arm Rests Photos	
	
Seat Belt	3 - Normal Wear & Tear
Seat Belt Condition	Seat belt secures properly. Belt is intact and in good condition



Inspection Report (Wheel Loader)

Seat Belt Photos	
Cabin Lights	3 - Normal Wear & Tear
Cabin Lights Condition	Cabin lights are installed with all light covers in place, bulbs are installed and working properly
Cabin Lights Photos	
Safety Lock Out / Stop	3 - Normal Wear & Tear
Safety Lock Out / Stop Condition	Safety lock out device is present, in good condition, and functional
Controls & Switches	3 - Normal Wear & Tear
Controls & Switches Condition	All switches are installed and functional
Controls & Switches Photos	



Inspection Report (Wheel Loader)





Inspection Report (Wheel Loader)

	
Hour Meter Activity	3 - Normal Wear & Tear
Hour Meter Condition	Hour meter is functional and in good condition
Hour Meter Activity Photos	
Other Gauge Activity	3 - Normal Wear & Tear
Other Gauge Condition	All cockpit gauges are functional and in good condition
Other Gauge Activity Photos	
Heater & A/C	3 - Normal Wear & Tear
Heater & A/C Condition	Heater and A/C work and transition through full temperature range

Inspection Report (Wheel Loader)

<p>Heater & A/C Photos</p>		
<p>Fans / Vents</p>	<p>3 - Normal Wear & Tear</p>	
<p>Fans / Vents Condition</p>	<p>Fan vents are functional, in good condition, and move through a full adjustable range of motion</p>	
<p>Fans / Vents Photos</p>		
		

Inspection Report (Wheel Loader)

	
	
Travel Alarm	3 - Normal Wear & Tear
Travel Alarm Condition	Travel alarm is installed and functioning as expected
Horn	3 - Normal Wear & Tear
Horn Condition	Horn is installed and functioning as expected
Backup Camera	3 - Normal Wear & Tear
Backup Camera Condition	Back up camera is installed and functioning as expected

Inspection Report (Wheel Loader)

Backup Camera Photos	
Fire Extinguisher	0
First Aid Kit	0

Engine Inspection Points

Engine	
Engine Type (Make, Model, Cylinders, Hp)	CAT 6.6L - 6CYL. - 142 HP
Emissions Tier	Tier 4i
Engine Serial Number	C8N2E464
Engine Fuel Type	Diesel
Engine Photos	

Inspection Report (Wheel Loader)





Inspection Report (Wheel Loader)





Inspection Report (Wheel Loader)



Inspection Report (Wheel Loader)

		
Blow-by (Visual Observation Check)	No	
Unusual Noises (Upon Start-up, Idle, Shutdown)	No	
Unusual Noise Notes	No unusual noises heard	
Engine Smoke (Upon Start-up, Idle, Shutdown)	No	
Engine Smoke Notes	No engine smoke issues observed	
Engine Exhaust Color	Clear	
Battery	3 - Normal Wear & Tear	
Battery Condition	Clean & dry appearance, tight connections	
Radiator	3 - Normal Wear & Tear	
Radiator Condition	Radiator fins & components appear to be in good working order, no signs of damage or leaks	
Radiator Photos		

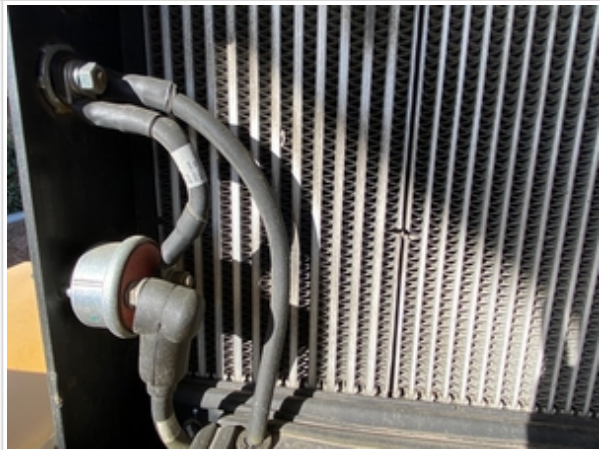
Inspection Report (Wheel Loader)

		
Belts	3 - Normal Wear & Tear	
Belt Condition	Belts appear in good condition & alignment with proper tension	
Hoses	3 - Normal Wear & Tear	
Hose Condition	Firm, pliant hoses with no signs of wear or leaks	
Hose Photos		
		

Inspection Report (Wheel Loader)

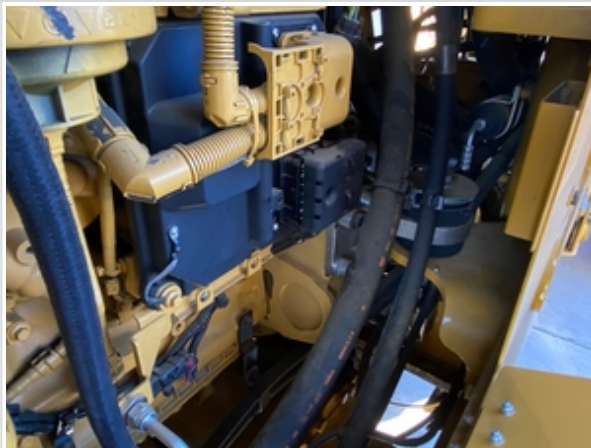

Inspection Report (Wheel Loader)



Inspection Report (Wheel Loader)

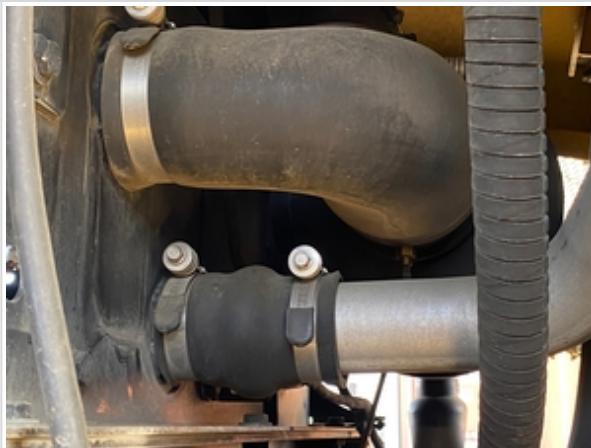

Inspection Report (Wheel Loader)



Inspection Report (Wheel Loader)

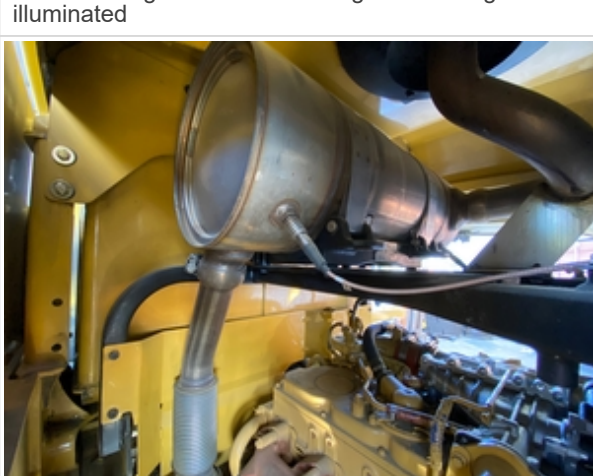

Inspection Report (Wheel Loader)

		
Water Pump	3 - Normal Wear & Tear	
Water Pump Condition	No unusual pump noises heard	
Cooling System Leaks	No	
Coolant Color / Appearance	3 - Normal Wear & Tear	
Coolant Color/Appearance Notes	Normal Translucent appearance, no visual signs of contamination	
Oil Leaks	No	
Oil Color / Appearance	3 - Normal Wear & Tear	
Oil Color / Appearance Notes	Clean oil appearance, no signs of cross contamination, Appropriate oil level	
Fuel Leaks	No	
Equipped with DPF (Diesel Particulate Filter)	Yes	
DPF Condition	3 - Normal Wear & Tear	
DPF Condition Notes	Filter housing is intact with no signs of damage or malfunction, DPF indicator is not illuminated	
DPF Photos		

Inspection Report (Wheel Loader)

	
Requires DEF (Diesel Exhaust Fluid)	No
Overall Engine Appearance	Clean & dry
Overall Engine Comments	Overall engine in solid condition. Engine runs and sounds healthy. Super clean engine compartment and no active leaks found.

Drivetrain Inspection Points



Drivetrain

Hydrostatic Transmission?	Yes
2 Speed?	Yes
Hydrostatic Drive Configuration	Split Transmission
Drive Motors	2 - Above Average Wear
Comments	Speed ranges from 1 to 4
Drive Motor Photos	

Inspection Report (Wheel Loader)

		
Hydrostatic Parking Brake	3 - Normal Wear & Tear	
Hydrostatic Parking Brake Condition	Good brake function	
Overall Drivetrain Comments	Overall drivetrain in great condition. Machine functions great in forward and reverse and hydrostatics sound great.	

Chassis Inspection Points

Frame	4 - Like New, Recently Replaced	
Frame Photos		
		



Inspection Report (Wheel Loader)



Inspection Report (Wheel Loader)



Inspection Report (Wheel Loader)

		
<p>Stance</p>	<p>3 - Normal Wear & Tear</p>	
<p>Stance Photos</p>		
		
<p>Front Axle Appearance</p>	<p>3 - Normal Wear & Tear</p>	

Inspection Report (Wheel Loader)



Front Axle Appearance Photos

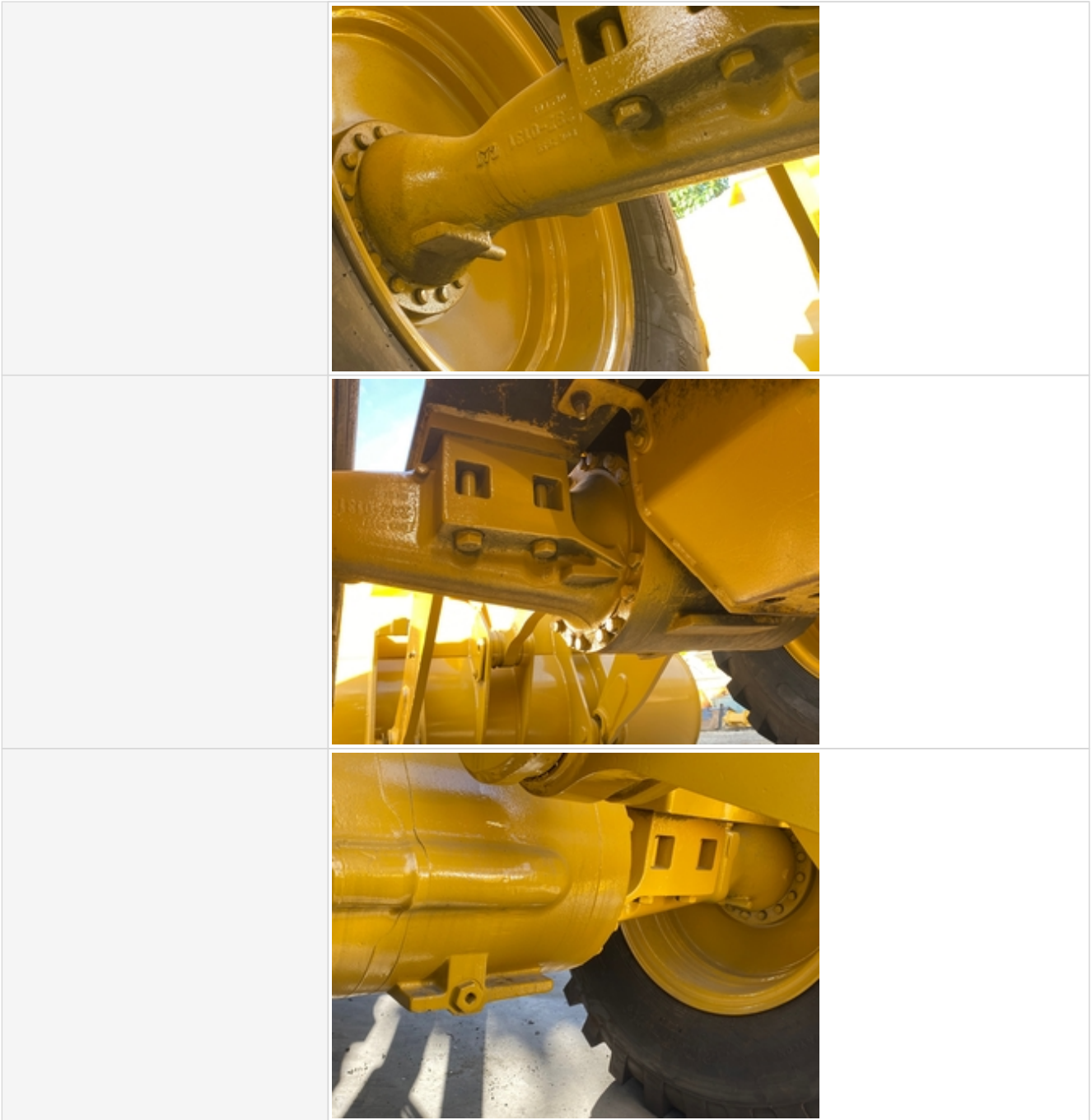

Inspection Report (Wheel Loader)



Inspection Report (Wheel Loader)

		
Rear Axle Appearance	3 - Normal Wear & Tear	
Rear Axle Appearance Photos		
		



Inspection Report (Wheel Loader)





**Articulating Center Pin
Appearance**

3 - Normal Wear & Tear



Inspection Report (Wheel Loader)

<p>Articulating Center Pin Appearance Photos</p>	
	
	
<p>Tire Brand</p>	<p>Duramax</p>
<p>Tire Size</p>	<p>20.5 x 25</p>
<p>Front Left Tire - Ratio Remaining</p>	<p>90%</p>
<p>Comments</p>	<p>Tires above 90% brand new</p>



Inspection Report (Wheel Loader)

<p>Front Left Tire Photos</p>	
	
	
<p>Rear Left Tire - Ratio Remaining</p>	<p>90%</p>
<p>Comments</p>	<p>Tires above 90% brand new</p>

Inspection Report (Wheel Loader)

Rear Left Tire Photos		
		
Front Right Tire - Ratio Remaining	90%	
Comments	Tires above 90% brand new	
Front Right Tire Photos		

Inspection Report (Wheel Loader)



		
Rear Right Tire - Ratio Remaining	90%	
Comments	Tires above 90% brand new	
Rear Right Tire Photos		
		
Lift Arm	3 - Normal Wear & Tear	

Inspection Report (Wheel Loader)

Lift Arm Photos



Inspection Report (Wheel Loader)



		
		
		
<p>Chassis to Arm Pins</p>	<p>3 - Normal Wear & Tear</p>	

Inspection Report (Wheel Loader)



Chassis to Arm Pins Photos



Inspection Report (Wheel Loader)

		
<p>Tilt Linkage</p>	<p>3 - Normal Wear & Tear</p>	
<p>Tilt Linkage Photos</p>		
		

Inspection Report (Wheel Loader)

	
Tilt Linkage Pins and Bushings	3 - Normal Wear & Tear
Tilt Linkage Pins and Bushings Photos	
Quick Coupler	0
Quick Coupler to Arms Pins	0
Overall Chassis	3 - Normal Wear & Tear
Overall Chassis Comments	Overall chassis in great condition with everything intact and no obvious major repairs needed.

Hydraulics Overall Inspection Points

Hydraulics Overall

Wet or Damp Hydraulic Lines / Fittings	No
Appearance of Hydraulic Lines / Fittings	3
Hydraulic Lines / Fittings Condition	Hydraulic lines & fittings are clean and in good condition

Inspection Report (Wheel Loader)

Appearance of Hydraulic Lines /
Fittings Photos



Inspection Report (Wheel Loader)



Inspection Report (Wheel Loader)



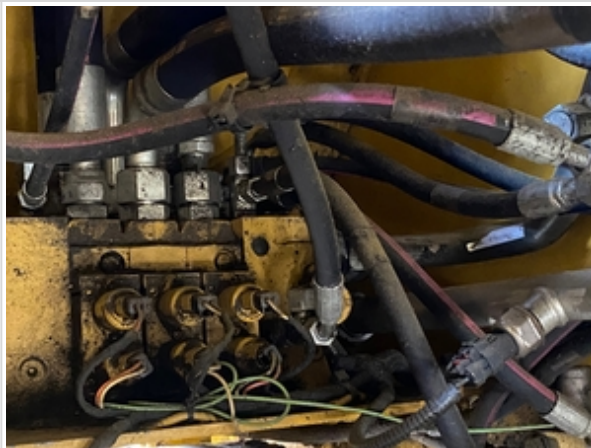

Inspection Report (Wheel Loader)



Inspection Report (Wheel Loader)





Inspection Report (Wheel Loader)

		
Unusual Noises (Hydraulic Pump)	No	
Hydraulic Pump Notes	No unusual noises heard during operation	
External Controls / Levers	3	
External Controls / Levers Condition	Good function & condition of hydraulic controls	
External Controls / Levers Photos		
		

Hydraulics Cylinders Inspection Points

Lift Cylinder	Check the lift cylinder. Note any wear, pitting, discoloration, etc. Take photos.
Lift Cylinder: Mounting Pin	3



Inspection Report (Wheel Loader)

Lift Cylinder: Oil Leaks	No
Lift Cylinder Photos	
	
	

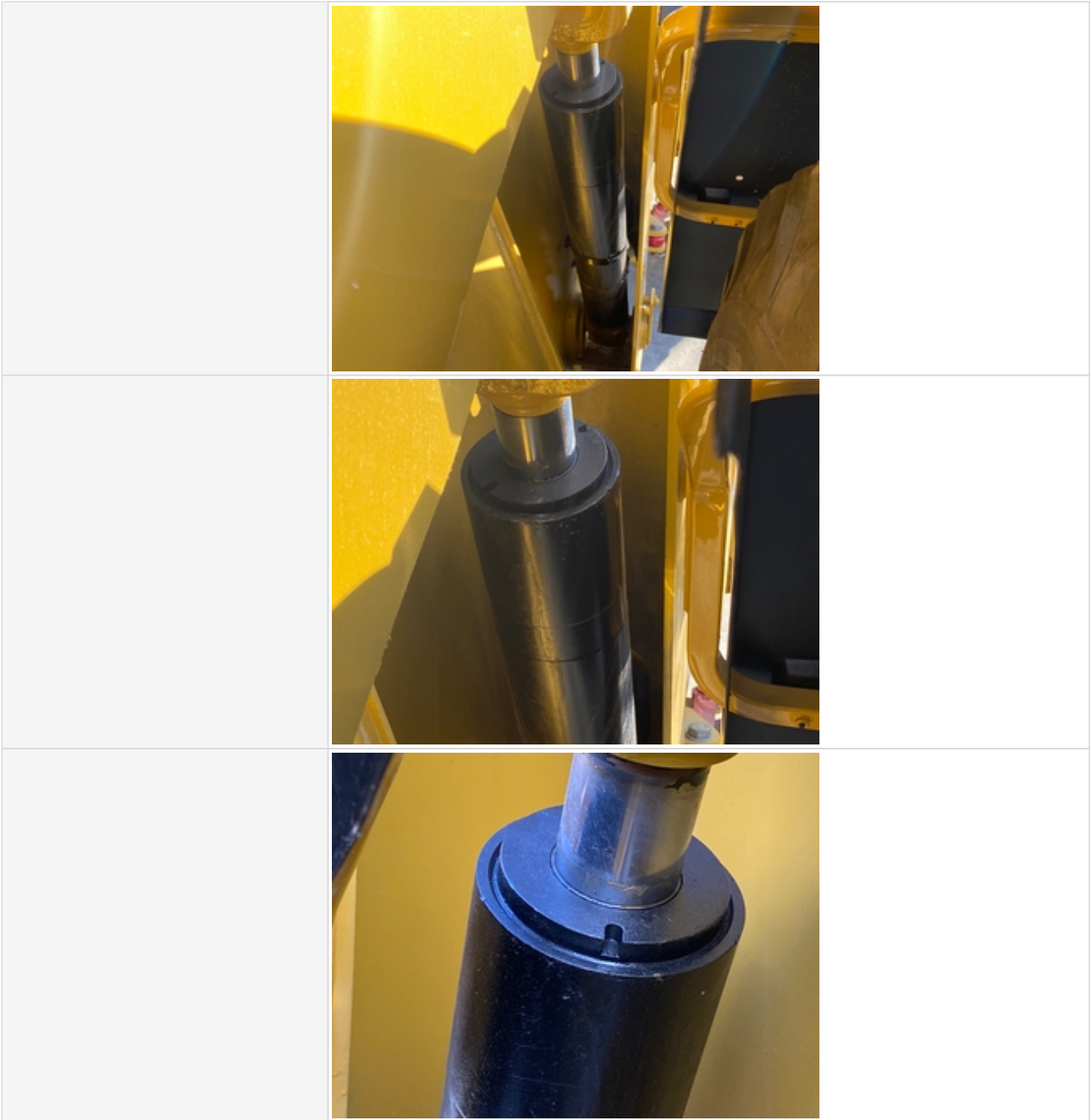

Inspection Report (Wheel Loader)





Inspection Report (Wheel Loader)

	
	
Bucket Cylinder	Check the bucket cylinder. Note any wear, pitting, discoloration, etc. Take photos.
Bucket Cylinder: Mounting Pin	3
Bucket Cylinder: Oil Leaks	No
Bucket Cylinder Photos	

Inspection Report (Wheel Loader)

		
		
		
Steering Cylinder	Check the steering cylinder. Note any wear, pitting, discoloration, etc. Take photos.	
Steering Cylinder: Mounting Pin	3	
Steering Cylinder: Oil Leaks	No	

Inspection Report (Wheel Loader)

Steering Cylinder Photos		
		

Bucket Inspection Points

Bucket	4 - Like New, Recently Replaced
Bucket Photos	

Inspection Report (Wheel Loader)



Inspection Report (Wheel Loader)



Inspection Report (Wheel Loader)



Bucket Edge/Shanks/Teeth

3 - Normal Wear & Tear

Inspection Report (Wheel Loader)

Bucket Edge/Shanks/Teeth Photos	
--	--

Functional Test

Forward & Reverse	3 - Normal Wear & Tear
Turning	3 - Normal Wear & Tear
Lift / Tilt	3 - Normal Wear & Tear
Bucket Functionality	3 - Normal Wear & Tear
Overall Functional Test Comments	Overall Machine runs great and all functions operate normal.
Operating Video	Click to Download

Overall Assessment

Overall Assessment	
Exterior Rating	4
Interior Rating	3
Safety Rating	3
Quality Rating	3
Functionality Rating	3
Overall Rating	3
What's Great About the Machine	This machine is in excellent looking condition. Exterior recently repainted with quality work and looks like a new wheel loader. This CAT loader underwent bumper to bumper repairs to ensure it works as well as it looks. No active leaks found. The front loader assembly tight and powertrain running great. The cab is in good condition in and out.
What Needs Work	Not much to list here. Machine does have many hours but has been well maintained. A few hydraulic hoses underneath showing signs of exterior wear. The rear radiator grill has some minor dents. (Cosmetic)
Any Additional Info from the Seller?	Seller is offering to swap GP bucket with one of two grapple buckets shown in bucket pictures (If customer would prefer to have grapple bucket). Both buckets fit this loader and will connect to the machines auxiliary hydraulics to function properly.
Date/Time	10-19-2022