

**Module de relais
Relay Module**

**Manuel de l'utilisateur
301RW
User Manual**

ERP 511397
02/07

Relay Module

301R
User Manual

ERP 511397
2/07

Notices and Trademarks

Copyright by Honeywell International Inc.
Release 511397 February 2007

While this information is presented in good faith and believed to be accurate, Honeywell disclaims the implied warranties of merchantability for a particular purpose and makes no express warranties except as may be stated in its written agreement with and for its customers.

In no event is Honeywell liable to anyone for any indirect, special or consequential damages. The information and specifications in this document are subject to change without notice.

Honeywell Analytics
4005 Matte Blvd, Unit G
Brossard, Quebec, J4Y 2P4

Contacts

World Wide Web

The following Honeywell Websites may be of interest to our customers:

Honeywell Organization	WWW Address (URL)
Honeywell Analytics	http://www.honeywellanalytics.com
Corporate	http://www.honeywell.com
International	http://content.honeywell.com/global/

Telephone

Contact us by telephone at the numbers listed below:







	Organization	Phone Number
United States and Canada	Honeywell Analytics	1-800-563-2967
		1-450-619-2450
		Fax: 1-888-967-9938
Asia Pacific	Honeywell Asia Pacific Inc. Hong Kong	(852) 23 31 9133
Europe	Honeywell Pace Brussels, Belgium	[32-2]728-2711
Latin America	Honeywell International Inc. Sunrise, Florida, U.S.A.	(954) 845-2600

Sales Informations

Contact us at sales@vulcaininc.com

Symbol Definitions

The following table lists the symbols used in this document to denote certain conditions:

Symbol	Definition
	ATTENTION: Identifies information that requires special consideration
	TIP: Identifies advice or hints for the user, often in terms of performing a task
	REFERENCE _ INTERNAL: Identifies an additional source of information within the bookset.
CAUTION	Indicates a situation which, if not avoided, may result in equipment or work (data) on the system being damaged or lost, or may result in the inability to properly operate the process.
	CAUTION: Indicates a potentially hazardous situation which, if not avoided, may result in minor or moderate injury. It may also be used to alert against unsafe practices.
	CAUTION: Symbol on the equipment refers the user to the product manual for additional information. The symbol appears next to required information in the manual.
	WARNING: Indicates a potentially hazardous situation which, if not avoided, could result in serious injury or death.
	WARNING symbol on the equipment refers the user to the product manual for additional information. The symbol appears next to required information in the manual.

CONTENTS

INTRODUCTION	11
Description	11
Installation Guidelines	11
WIRING DETAILS	12
301R Wiring	12
301RW Wiring	13
System Configuration	14
DIP Switches	14
LED Definitions	15
Care and Maintenance	15
Replacement parts	15
SPECIFICATIONS	16
Technical Specifications	16
LIMITED WARRANTY	17
Limited Warranty	17
Re-Stocking Policy	17
Exclusions	18
Warranty Limitation and Exclusion	18
Disclaimer of Unstated Warranties	19
Limitation of Liability	19

Introduction

Description

The 301R and 301RW act as an output for the 201C or the 301C. The 301R and the 301RW provides a standard 8 relays (DPDT 5A, 30 Vdc or 250 Vac resistive load) for the indirect activation of accessories. Since the relay module is an output for the controller, it can be located anywhere within the gas detection network.

The 301R is fully compatible with both the 201C and the 301C (the 301RW is compatible with only the 301CW) and offer LED indicators for each relay (visible only when housing is open).

Installation Guidelines

The following guidelines ensure that the equipment will work properly. Failure to strictly respect these guidelines will free Honeywell from any responsibility or liability in case of improper functioning:

- Make sure to locate the unit and sensing assembly(ies), if applicable, in an area easily accessible to a technician.
- Avoid any location where the unit could be subject to vibrations.
- Avoid any location close to noisy equipment.
- Avoid any location where temperature changes occur rapidly.
- Verify all the requirements and existing regulations which may affect the choice of location.

Wiring Details

301R Wiring

The wiring details diagram (below) represent the 8 DPDT relay circuit board. Wiring connexions are identical, regardless of the number of relays.

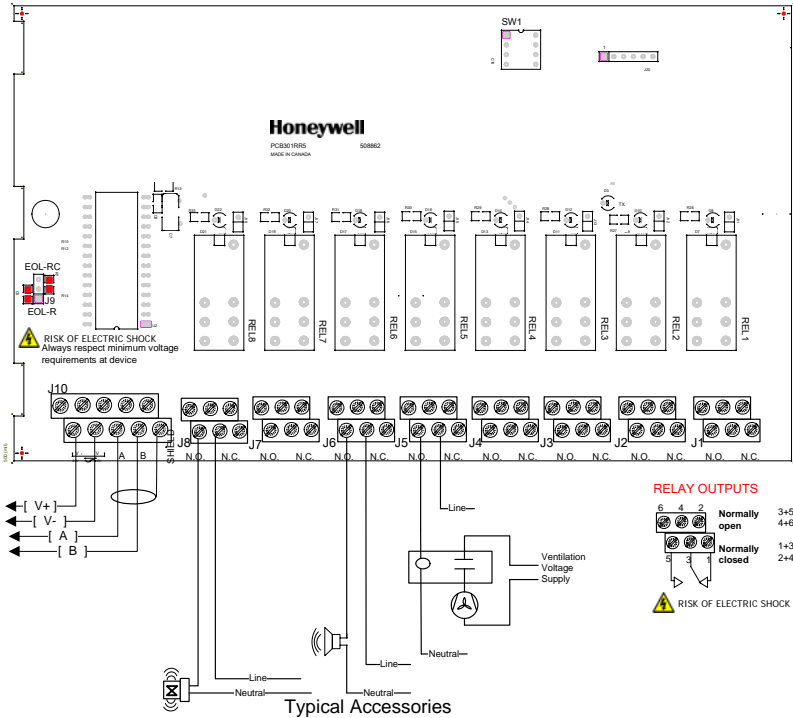

System Configuration

DIP Switches

The DIP switches are used to change relay module addresses. If the relay module is connected to a 301C controller, the addresses range available begins at 81. If it is connected to a 201C, the range of addresses begins at 1 or 17.

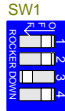

PRODUCT ADDRESSES		DIP SWITCH POSITIONS			
VA201C	VA301C	Dip1	Dip2	Dip3	Dip4
1 or 17	81	Off	Off	Off	Off
2 or 18	82	On	Off	Off	Off
3 or 19	83	Off	On	Off	Off
4 or 20	84	On	On	Off	Off
5 or 21	85	Off	Off	On	Off
6 or 22	86	On	Off	On	Off
7 or 23	87	Off	On	On	Off
8 or 24	88	On	On	On	Off
9 or 25	89	Off	Off	Off	On
10 or 26	90	On	Off	Off	On
11 or 27	91	Off	On	Off	On
12 or 28	92	On	On	Off	On
13 or 29	93	Off	Off	On	On
14 or 30	94	On	Off	On	On
15 or 31	95	Off	On	On	On
16 or 32	96	On	On	On	On

The wireless module (Coordinator PCB) uses Modbus communication to transmit network information to the 301RW (PCB). A 301R, equipped with a wireless module, uses addresses 81 and 82 (81 is the default address) for communication between the wireless and relay modules.

Resetting Network Parameters Using the Dip Switch

Since the 301RW has no programming interface, the DIP switches can be used to change network parameters: a change of address done using the DIP switch when the unit is powered up resets network parameters to zero. This function, ***which should only be used by authorized and qualified technicians***, resets network parameters to zero, allowing the 301RW to search for a controller in association mode.

ATTENTION

This function resets network parameters; when parameters are reset, identifiers may change, which renders Events and Groups programmed in the controller invalid and useless.

Note: Parameters will not be reset if the address is change when the unit is off.

LED Definitions

The unit has two externally visible LEDs:

The green LED indicates power status. When the unit is powered up and function the LED is lit, when the LED is off, the unit is off

The amber LED indicates communication status. This LED blinks to indicate communication between the relay module and the controller.

Specifications

Technical Specifications

Specifications

Technical Specifications

Power Requirements:	17 - 27 Vac, 50/60 Hz, 9.5 VA 24 - 38 Vdc, 250 mA @ 24Vdc (8.4 VA)
Operating Temperature	
Range:	32°F to 100°F (0 to 40°C)
Operating Humidity Range:	0 to 95% RH (non-condensing)
Outputs:	2, 4 or 8 DPDT relays 5A, 30 Vdc or 250 Vac (resistive load)
Communication (length of lines)	2,000 feet (600 m) maximum between the Controller and transmitter:
Communication:	Modbus ASCII or ISM wireless
Enclosure:	ABS and polycarbonate
Dimensions:	8 in (H) x 9.5 in (W) x 2.5 in (D) (20.3 cm x 24.4 cm x 5.7 cm)

Care and Maintenance

The 301RW is a maintenance free relay module. If cleaning is necessary, clean the exterior with a soft, damp cloth. Do not use solvents, soaps or polishers.

Replacement parts

Due to continuous evolution of our products, please contact our service department to order parts if needed or to ask for more details.

Limited Warranty

Limited Warranty

Honeywell Analytics, Inc. warrants to the original purchaser and/or ultimate customer ("Purchaser") of Vulcain products ("Product") that if any part thereof proves to be defective in material or workmanship within twelve (12) months, such defective part will be repaired or replaced, free of charge, at Honeywell Analytics' discretion if shipped prepaid to Honeywell Analytics at 4005 Matte Blvd., Unit G, Brossard, Quebec, J4Y 2P4, in a package equal to or in the original container. The Product will be returned freight prepaid and repaired or replaced if it is determined by Honeywell Analytics that the part failed due to defective materials or workmanship. The repair or replacement of any such defective part shall be Honeywell Analytics' sole and exclusive responsibility and liability under this limited warranty.

Re-Stocking Policy

The following re-stocking fees will apply when customers return products for credit:

- 15% re-stocking fee will be applied if the product is returned within **1 month** following the shipping date
- 30% re-stocking fee will be applied if the product is returned within **3 months** following the shipping date

A full credit (less re-stocking fee) will only be issued if the product is in perfect working condition. (If repairs are required on the returned product, the cost of these repairs will be deducted from the credit to be issued.)

No credits will be issued beyond the three month period.

Exclusions

- a.If Gas sensors are part of the Product, the gas sensor is covered by a twelve (12) month limited warranty of the manufacturer.
- b.If gas sensors are covered by this limited warranty, the gas sensor is subject to inspection by Honeywell Analytics for extended exposure to excessive gas concentrations if a claim by the Purchaser is made under this limited warranty. Should such inspection indicate that the gas sensor has been expended rather than failed prematurely, this limited warranty shall not apply to the Product.
- c.This limited warranty does not cover consumable items, such as batteries, or items subject to wear or periodic replacement, including lamps, fuses, valves, vanes, sensor elements, cartridges, or filter elements.

Warranty Limitation and Exclusion

Honeywell Analytics will have no further obligation under this limited warranty. All warranty obligations of Honeywell Analytics are extinguishable if the Product has been subject to abuse, misuse, negligence, or accident or if the Purchaser fails to perform any of the duties set forth in this limited warranty or if the Product has not been operated in accordance with instructions, or if the Product

serial number has been removed or altered.

Disclaimer of Unstated Warranties

The warranty printed above is the only warranty applicable to this purchase. All other warranties, express or implied, including, but not limited to, the implied warranties of merchantability or fitness for a particular purpose are hereby disclaimed.

Limitation of Liability

It is understood and agreed that Honeywell Analytics' liability, whether in contract, in tort, under any warranty, in negligence or otherwise shall not exceed the amount of the purchase price paid by the purchaser for the product and under no circumstances shall Honeywell Analytics be liable for special, indirect, or consequential damages. The price stated for the product is a consideration limiting honeywell analytics' liability. No action, regardless of form, arising out of the transactions under this warranty may be brought by the purchaser more than one year after the cause of actions has occurred.

