

ACLCMAGDJ

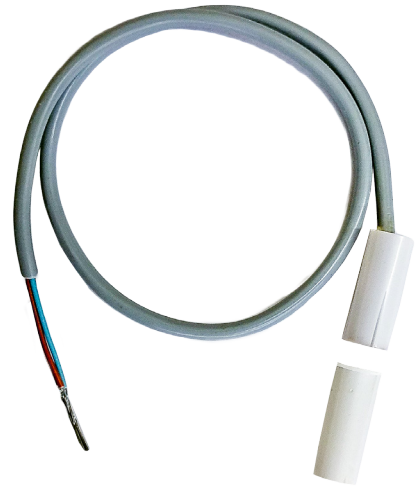

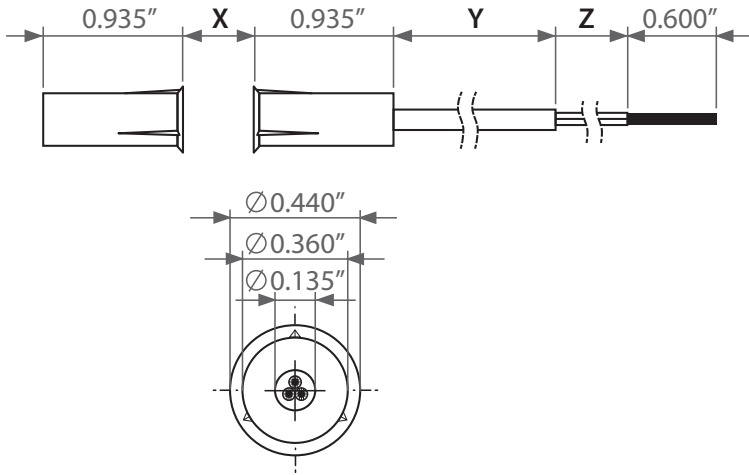



Recessed Mount Magnetic Switch, Form C (SPDT)

MAGNETIC SWITCH FOR CLOSET LIGHT CONTROLLERS



Specifications

- Switching Voltage (Max): 200 Vdc
- Switching Current (Max): 0.5 Amp
- Operating Gap (Min): 0.375" (Dimension X)
- Dimension Y: Approx. 12"
- Dimension Z: Approx. 1"

| Wire Color | Normal State | Door Closed | Door Open |
|------------|--------------|--|---|
| Brown | Common |  |  |
| Black | N/O |  |  |
| Blue | N/C |  |  |