



**Struttura:** in legno multistrati con molleggio garantito da cinghie elastiche ad alta componente di caucciù.

**Preparazione della struttura:** sedile in poliuretano espanso a quote differenziate ad alta densità con sede concava per accogliere il cuscino migliorandone sofficità e durata. Braccioli e schienali rivestiti nella parte superiore con materiale termosensibile (Memory Foam). Ulteriore rivestimento in fibra termolegata trasparente accoppiata con tela di cotone bianca anallergica che conferisce morbidezza.

**Cuscinatura:** imbottitura cuscino schienale e sedile in piuma d'oca canalizzata (certificata Assopiuma, etichetta oro) con inserto centrale in poliuretano espanso a quote differenziate ad alta resilienza. Cuscini sedile completamente reversibili.

**Sfoderabilità:** cuscini sedile, cuscini schienale e struttura completamente sfoderabili in tutte le versioni (tessuto e pelle).

**Base:** portante in estruso di alluminio (disegno esclusivo Minotti Studio) verniciata extra-lucido anti-touch nel colore Peltro. Appoggio a terra tramite scivolanti protettivi in nylon.

**Poggiatesta:** realizzato con una struttura interna rigida, ma flessibile. Può essere facilmente collocato tra schienale e cuscini per garantire il giusto supporto. Le caratteristiche impunture "Cambré" creano un elegante motivo matelassé e danno risalto al rivestimento in tessuto o pelle che è completamente sfoderabile.

**N.B.:** per agevolare la sfoderabilità e la consegna, i braccioli e gli schienali sono sfilabili dalla base tramite un sistema di innesto e sgancio rapido.

**Structure:** in multiply wood, seat suspension is provided by elastic straps with a high rubber content.

**Structure preparation:** the seat structure is made of high resilience, variable-density polyurethane foam with a concave contour to cradle the cushion, maximizing softness and durability. The upper portion of the armrests and backrests is made of temperature sensitive Memory Foam. An additional casing in breathable heat-bonded fiber laminated to white hypoallergenic cotton fabric lends superior softness.

**Cushions:** channeled goose down (certified Assopiuma, gold label) padding for backrests and cushions with center insert in high resilience, variable-density polyurethane foam. Seat cushions are completely reversible.

**Covers:** seat cushions, backrest cushions and structure covers are completely removable in all versions (fabric and leather).

**Base:** weight-bearing parts in extruded aluminum (exclusive Minotti Studio design) with high-gloss, anti-fingerprint, painted Pewter color finish. Rests on nylon slides.

**Headrest:** crafted with an inner structure that is rigid, but flexible. It can easily be positioned between the backrest and the cushions to ensure just the right support. The typical "Cambré" stitching creates an elegant matelassé motif, bringing out the beauty of the fabric or leather upholstery which is fully removable.

**N.B.:** to facilitate transport and removal of covers, the armrests and backrests can be removed from the base through a system of quick set and release closures.

**Gestell:** Aus mehrschichtigem Holz, Sitzfederung mit elastischen Gurten mit hohem Kautschukanteil.

**Aufbereitung des Gestells:** Aufbereitung der Sitzstruktur mit unterschiedlich dick geschäumtem, hochdichtem Polyurethan mit konkaver Sitzfläche, um das Sitzkissen aufzunehmen und den Sitz weicher und robuster zu machen. Arm- und Rückenlehnen am oberen Teil mit thermosensiblen Material bezogen (Memory Foam). Ein weiterer Bezug ist aus atmungsaktiver, thermofixierter Faser, kombiniert mit antiallergischem, weißem Baumwolltuch, das elastische Weichheit verleiht. **Kissen:** Polsterung des Rücken- und Sitzkissens aus kanalisiertem Gänseedaunen (Gold Label, zertifiziert von Assopiuma) mit zentraler Einlage aus unterschiedlich dickem, federndem hochdichtem Polyurethanschaum. Sitzkissen beidseitig verwendbar.

**Abziehbarkeit:** Sitz- und Rückenlehnen, sowie Struktur in allen Varianten (Stoff- und Lederbezug) vollkommen abziehbar.

**Grundgestell:** Tragende Teile aus Aluminiumguss (exklusives Design von Minotti Studio), Zinnfarbig lackiert mit glänzendem Anti-Touch-Finish. Bodenaufgabe mit Gleitschutz aus Nylon.

**Kopfstütze:** Die interne Struktur ist nicht zu weich, aber flexibel, und sie kann ganz einfach zwischen der Rückenlehne und den Kissen angebracht werden, um den rechten Halt zu garantieren. Die charakteristische Nahte "Cambré" bilden einen eleganten Steppeffekt und heben den Stoff- oder Lederbezug hervor, der vollkommen abziehbar ist.

**N.B.:** Um das Abziehen und den Transport zu vereinfachen, sind Arm- und Rückenlehnen über ein praktisches, schnelles Stecksystem mit dem Untergestell verbunden.

**Structure:** en bois contreplaqué avec suspension garantie par des courroies élastiques à forte teneur en caoutchouc.

**Préparation de la structure :** d'assise en polyuréthane expansé à densité différenciée et haute densité, avec logement concave pour accueillir le coussin et en améliorer le moelleux et la durée. Accoudoirs et dossiers doublés de mousse thermosensible à mémoire de forme (Memory Foam) dans la partie supérieure. Second revêtement en fibre thermolée respirante, doublée de toile de coton blanc anallergique pour davantage de souplesse.

**Coussins :** rembourrage du coussin de dossier et d'assise en plume d'oise canalisée (certifiée Assopiuma, étiquette d'or) avec insert central en polyuréthane expansé à densité différenciée haute résilience. Coussins d'assise entièrement réversibles.

**Déhoussage :** coussins d'assise, coussins de dossier et structure entièrement déhoussables dans toutes les versions (tissu et cuir).

**Base :** portante en aluminium extrudé (d'après un dessin exclusif de Minotti Studio), peinture extra brillante anti-trace couleur Étain. Patins glisseurs en nylon.

**Appui-tête:** réalisé avec une structure interne rigide mais flexible. Il peut être facilement placé entre le dossier et les coussins afin de garantir un bon support. Les coutures caractéristiques "Cambré" créent un motif matelassé élégant et soulignent le revêtement en tissu ou en cuir qui est entièrement déhoussable.

**N.B. :** pour faciliter le déhoussage et la livraison, les accoudoirs et les dossiers peuvent être démontables de la base grâce à un mécanisme d'enclenchement et déclenchement rapide.

### POSIZIONE CUSCINO SCHIENALE CON O SENZA POGGIATESTA | BACKREST CUSHION POSITION WITH OR WITHOUT HEADREST

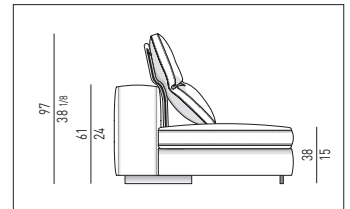
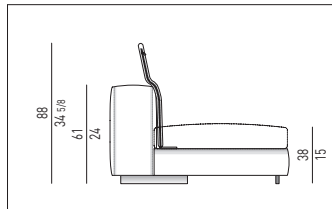
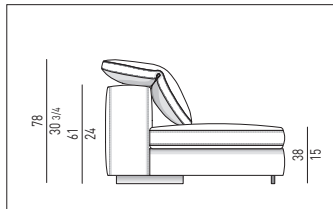

Grazie ad un particolare sistema di confezione, il cuscino presenta una piega sul dorso che fa sì che possa essere utilizzato su ambedue i lati, rispondendo a diverse funzionalità: morbidamente adagiato sullo schienale oppure sul bracciolo, o appoggiato al poggiatesta per un supporto ancora più confortevole.

Another very defining characteristic of the Yang seating system is its reversible backrest cushion. The back fold allows it to be used on both sides, and in so doing has various functions: softly placed on the backrest or on the armrest, or on the headrest for added comfortable support.

Dank der spezifischen Anfertigung, das Kissen verfügt über eine Falte auf der Rückseite, kann es beidseitig benutzt werden und mehrere Funktionen erfüllen: Es kann locker auf die Rückenlehne oder auf die Armlehne gelegt, oder an die Kopfstütze angelehnt werden, um den Komfort noch zu erhöhen.

En raison de son système de confection, l'envers du coussin présente un pli permettant de l'utiliser des deux côtés, et de remplir différentes fonctions : il peut être simplement posé contre le dossier ou sur l'accoudoir, ou bien sur l'appui-tête pour en augmenter le confort.

### ALTEZZE E PROFONDITÀ | HEIGHTS AND DEPTHS

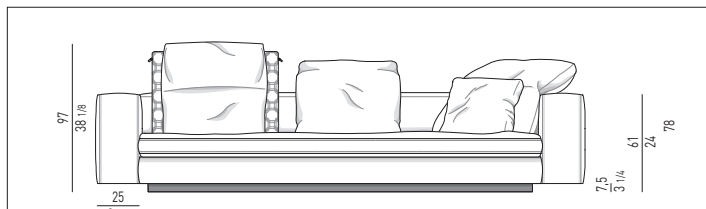

### POSIZIONE BASE | BASE POSITION

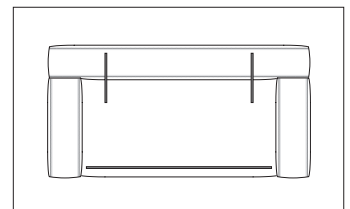

**FINITURA BASE**  
**BASE FINISH**

**ALLUMINIO | ALUMINUM**

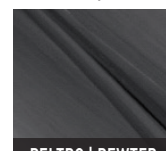

**PELTRO | PEWTER**

# Minotti

## DIVANI | SOFAS

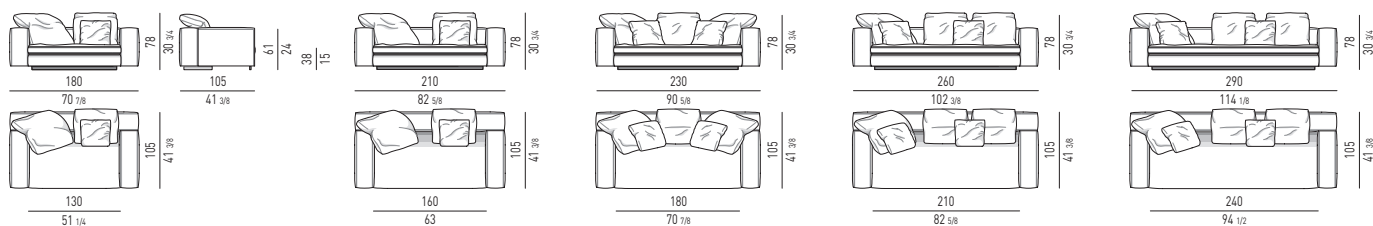

## DIVANI COMPOSTI | COMPOSED SOFAS

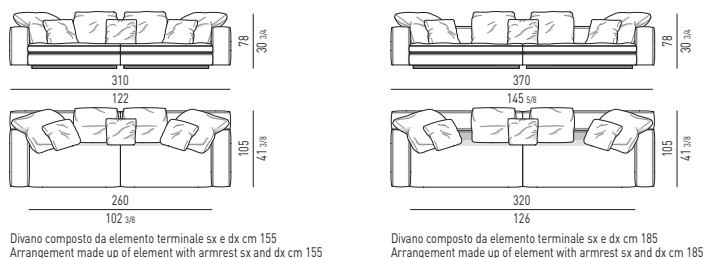

Divano composto da elemento terminale sx e dx cm 155  
Arrangement made up of element with armrest sx and dx cm 155

Divano composto da elemento terminale sx e dx cm 185  
Arrangement made up of element with armrest sx and dx cm 185

## DIVANI-DAYBED | DAYBED-SOFAS

DIVANO-DAYBED CM 260 - SCHIENALE CM 180  
DAYBED-SOFA CM 260 - BACKREST CM 180

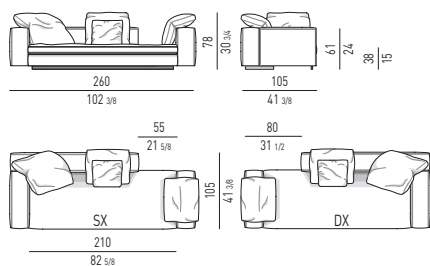

DIVANO-DAYBED CM 290 - SCHIENALE CM 185  
DAYBED-SOFA CM 290 - BACKREST CM 185

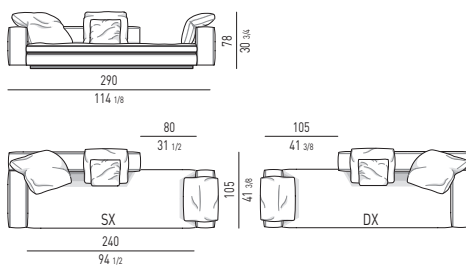

## ELEMENTI DAYBED | DAYBED ELEMENTS

ELEMENTO DAYBED CM 185 - SCHIENALE CM 105  
DAYBED ELEMENT CM 185 - BACKREST CM 105

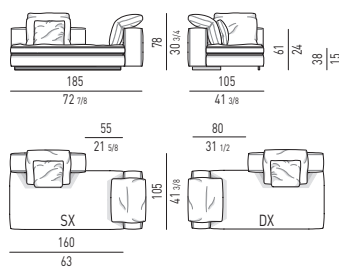

ELEMENTO DAYBED CM 235 - SCHIENALE CM 155  
DAYBED ELEMENT CM 235 - BACKREST CM 155

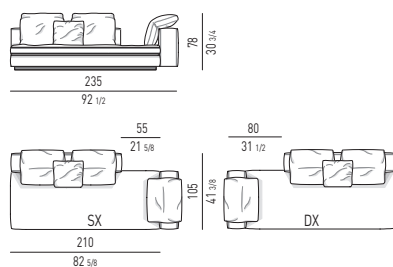

ELEMENTO DAYBED CM 265 - SCHIENALE CM 145  
DAYBED ELEMENT CM 265 - BACKREST CM 145

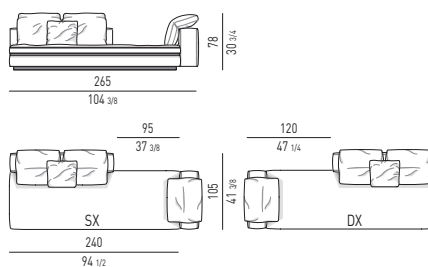

ELEMENTO DAYBED CM 265 - SCHIENALE CM 185  
DAYBED ELEMENT CM 265 - BACKREST CM 185

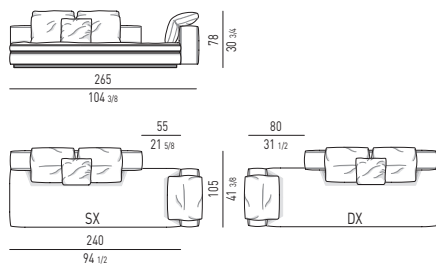

## ELEMENTI TERMINALI | ELEMENTS WITH ONE ARMREST

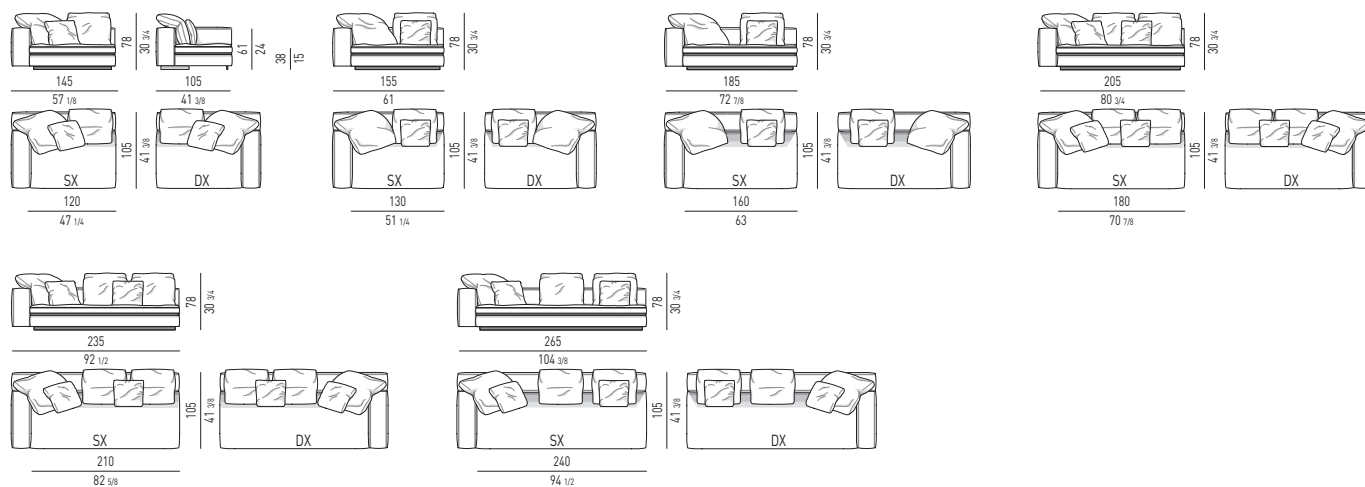

## ELEMENTI TERMINALI PENISOLA | OPEN-END ELEMENTS WITH ARMREST

ELEMENTO TERMINALE PENISOLA CM 185 - SCHIENALE CM 105  
OPEN-END ELEMENT WITH ARMREST CM 185 - BACKREST CM 105

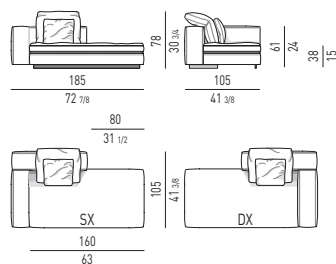

ELEMENTO TERMINALE PENISOLA CM 185 - SCHIENALE CM 130  
OPEN-END ELEMENT WITH ARMREST CM 185 - BACKREST CM 130

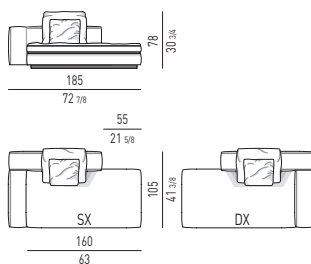

ELEMENTO TERMINALE PENISOLA CM 205 - SCHIENALE CM 150  
OPEN-END ELEMENT WITH ARMREST CM 205 - BACKREST CM 150

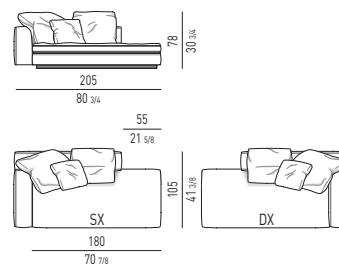

ELEMENTO TERMINALE PENISOLA CM 235 - SCHIENALE CM 155  
OPEN-END ELEMENT WITH ARMREST CM 235 - BACKREST CM 155

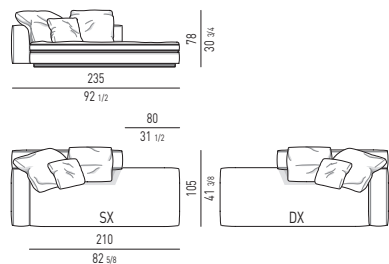

ELEMENTO TERMINALE PENISOLA CM 235 - SCHIENALE CM 180  
OPEN-END ELEMENT WITH ARMREST CM 235 - BACKREST CM 180

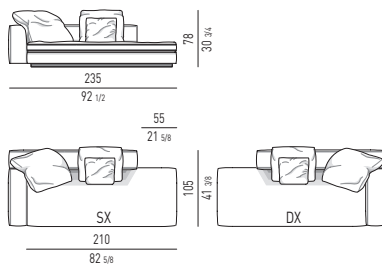

ELEMENTO TERMINALE PENISOLA CM 265 - SCHIENALE CM 185  
OPEN-END ELEMENT WITH ARMREST CM 265 - BACKREST CM 185

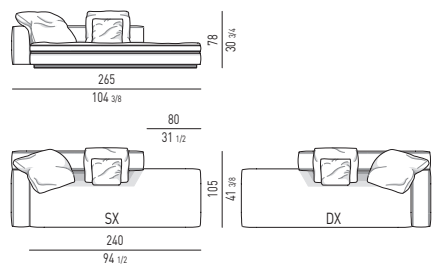

ELEMENTO TERMINALE PENISOLA CM 265 - SCHIENALE CM 210  
OPEN-END ELEMENT WITH ARMREST CM 265 - BACKREST CM 210

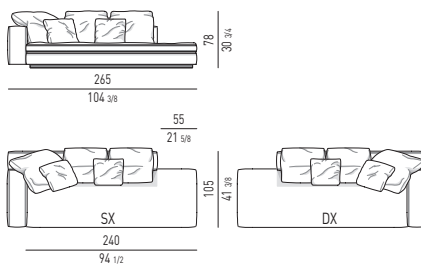

# Minotti

## ELEMENTI PENISOLA | OPEN-END ELEMENTS

ELEMENTO PENISOLA CM 160 - SCHIENALE CM 80  
OPEN-END ELEMENT CM 160 - BACKREST CM 80

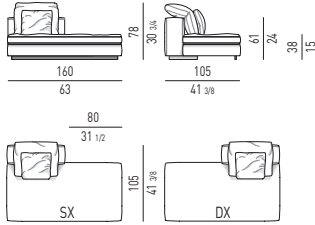

ELEMENTO PENISOLA CM 160 - SCHIENALE CM 105  
OPEN-END ELEMENT CM 160 - BACKREST CM 105

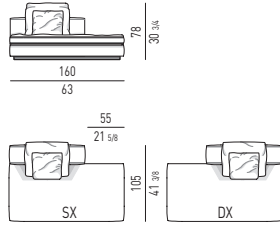

ELEMENTO PENISOLA CM 210 - SCHIENALE CM 130  
OPEN-END ELEMENT CM 210 - BACKREST CM 130

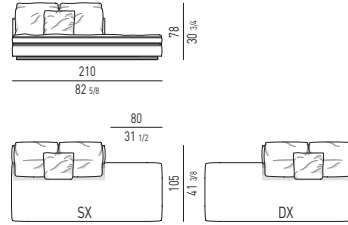

ELEMENTO PENISOLA CM 210 - SCHIENALE CM 155  
OPEN-END ELEMENT CM 210 - BACKREST CM 155

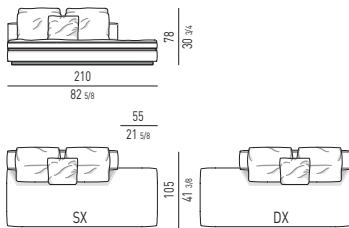

ELEMENTO PENISOLA CM 240 - SCHIENALE CM 160  
OPEN-END ELEMENT CM 240 - BACKREST CM 160

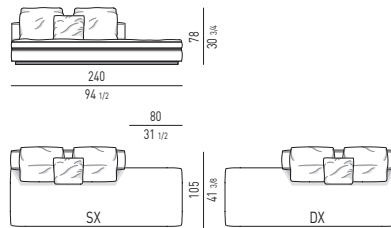

ELEMENTO PENISOLA CM 240 - SCHIENALE CM 185  
OPEN-END ELEMENT CM 240 - BACKREST CM 185

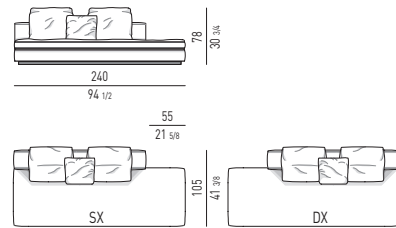

## ELEMENTI CENTRALI | CENTRAL ELEMENTS

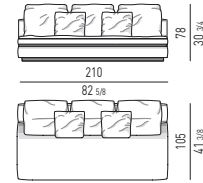
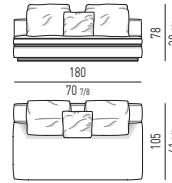
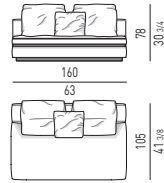
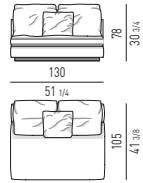
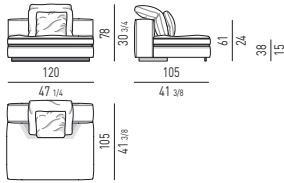

## COUCH

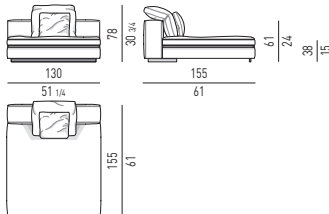



# Minotti

## CHAISE-LONGUE

CHAISE-LONGUE CM 105X185 - BRACCIOLO CM 80  
CHAISE-LONGUE CM 105X185 - ARMREST CM 80

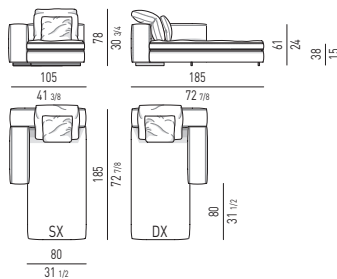

CHAISE-LONGUE CM 155X155 - BRACCIOLO CM 80  
CHAISE-LONGUE CM 155X155 - ARMREST CM 80

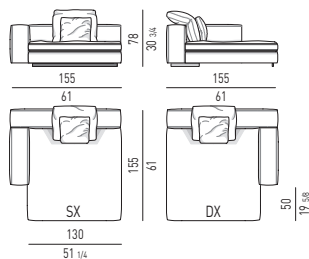

CHAISE-LONGUE CM 155X155 - BRACCIOLO CM 130  
CHAISE-LONGUE CM 155X155 - ARMREST CM 130

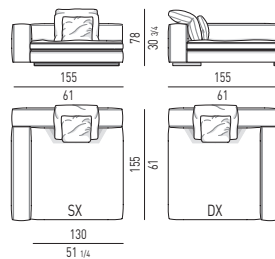

## POUF | OTTOMANS

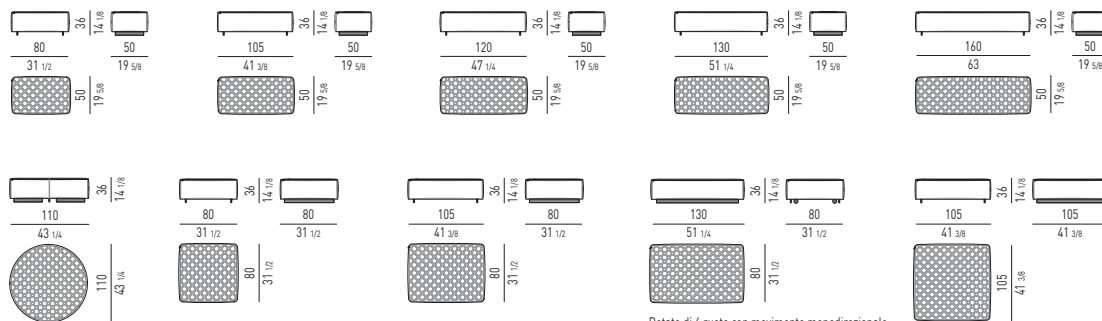

POGGIATESTA OPTIONAL "YANG"  
"YANG" OPTIONAL HEADREST

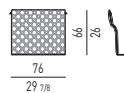

CUSCINO SCHIENALE OPTIONAL "YANG"  
"YANG" OPTIONAL BACKREST CUSHION

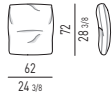

CUSCINO OPTIONAL "YANG"  
"YANG" OPTIONAL CUSHION



RULLO OPTIONAL "YANG"  
"YANG" OPTIONAL ROLL

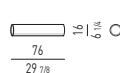

## ELEMENTI "OFFSET" | "OFFSET" ELEMENT

### "OFFSET" ELEMENTI PENISOLA | "OFFSET" OPEN-END ELEMENTS

"OFFSET" ELEMENTO PENISOLA CM 235 - SCHIENALE CM 155  
"OFFSET" OPEN-END ELEMENT CM 235 - BACKREST CM 155

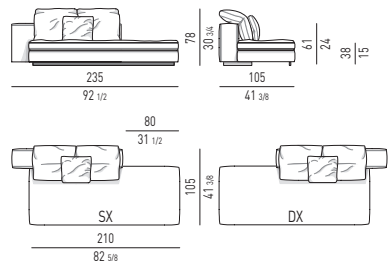

"OFFSET" ELEMENTO PENISOLA CM 235 - SCHIENALE CM 180  
"OFFSET" OPEN-END ELEMENT CM 235 - BACKREST CM 180

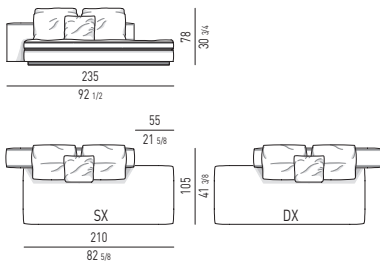

"OFFSET" ELEMENTO PENISOLA CM 265 - SCHIENALE CM 195  
"OFFSET" OPEN-END ELEMENT CM 265 - BACKREST CM 195

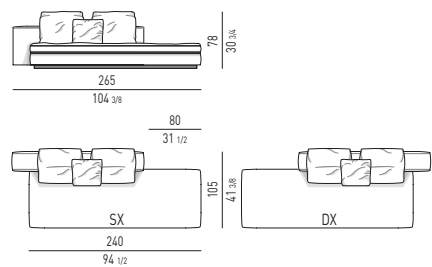

"OFFSET" ELEMENTO PENISOLA CM 265 - SCHIENALE CM 210  
"OFFSET" OPEN-END ELEMENT CM 265 - BACKREST CM 210

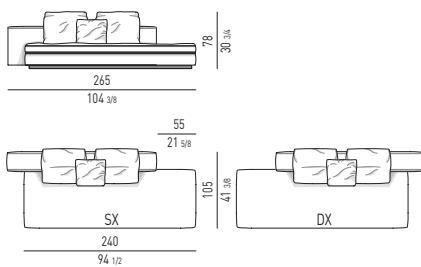

### "OFFSET" ELEMENTI CENTRALI | "OFFSET" CENTRAL ELEMENT

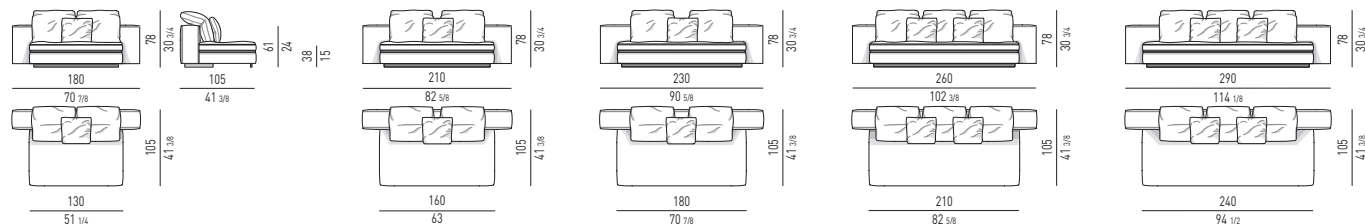

### "OFFSET" TERMINALI CON BRACCIOLO | "OFFSET" ELEMENTS WITH ONE ARMREST

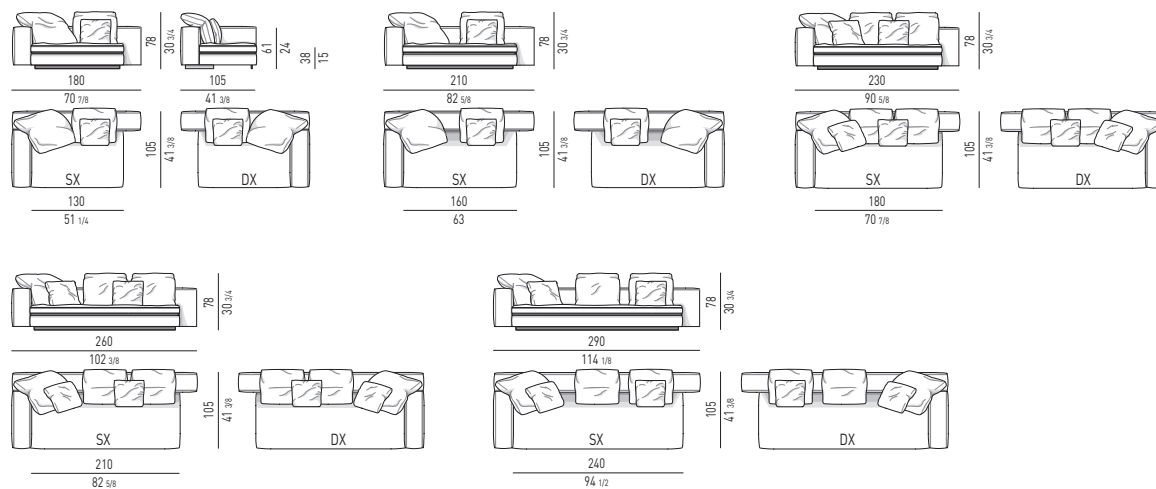

# Minotti

## "OFFSET" TERMINALI SENZA BRACCIOLO | "OFFSET" ELEMENTS WITHOUT ARMREST

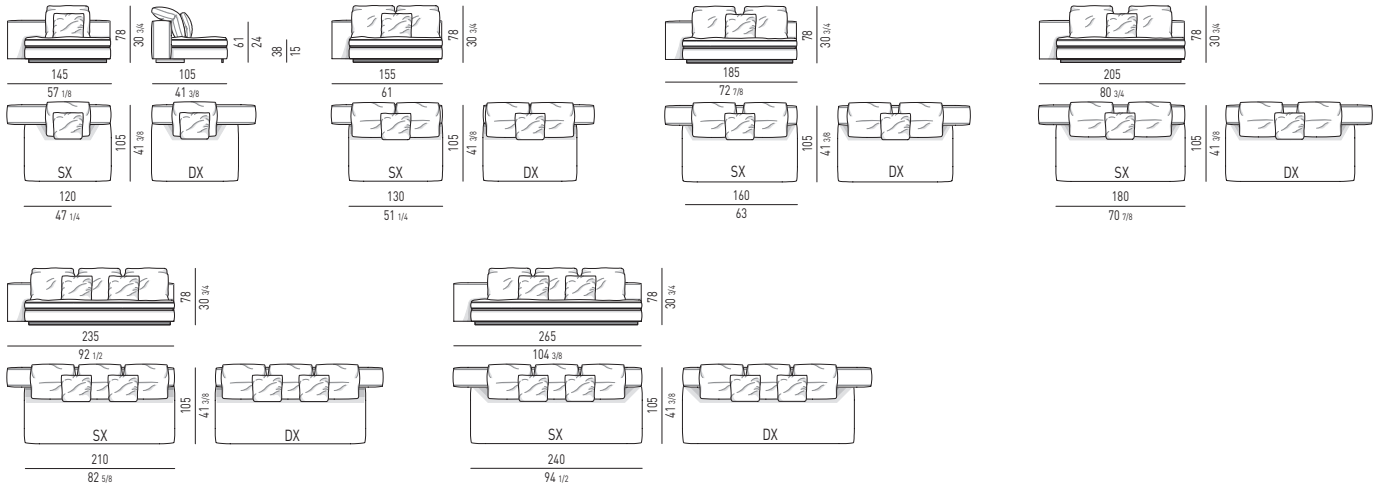

## "OFFSET" DAYBED

"OFFSET" DAYBED CM 260 - SCHIENALE CM 180  
"OFFSET" DAYBED CM 260 - BACKREST CM 180

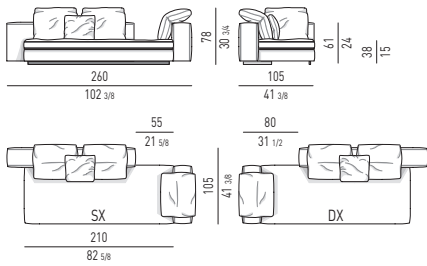

"OFFSET" DAYBED CM 290 - SCHIENALE CM 185  
"OFFSET" DAYBED CM 290 - BACKREST CM 185

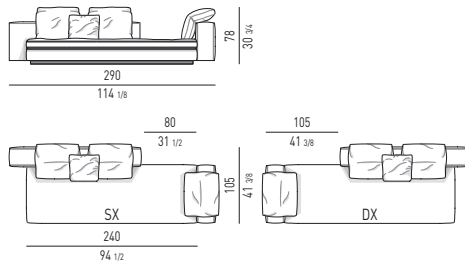

## "OFFSET" COUCH

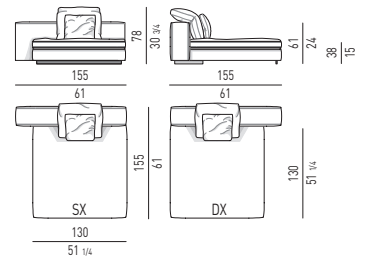

## POUF | OTTOMANS

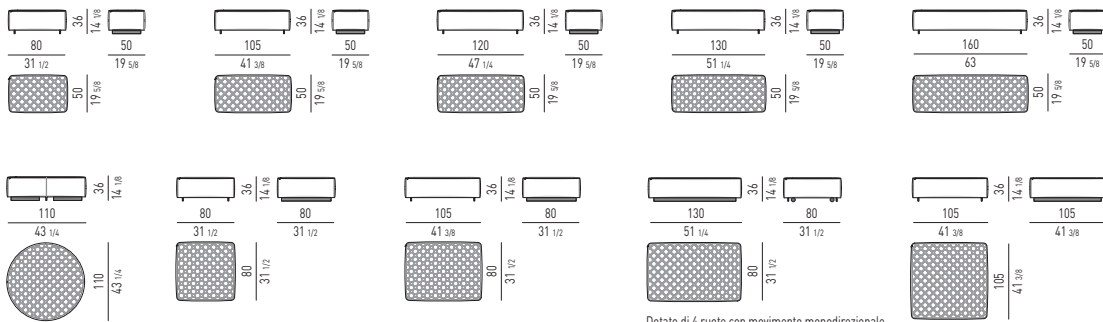

Dolati di 4 ruote con movimento monodirezionale  
With 4 one-way motion castors

POGGIATESTA OPTIONAL "YANG"  
"YANG" OPTIONAL HEADREST

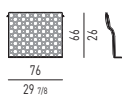

CUSCINO SCHIENALE OPTIONAL "YANG"  
"YANG" OPTIONAL BACKREST CUSHION

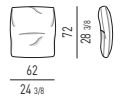

CUSCINO OPTIONAL "YANG"  
"YANG" OPTIONAL CUSHION



RULLO OPTIONAL "YANG"  
"YANG" OPTIONAL ROLL

