



Caratteristiche: La linea pulita della scocca, unita al piede a ponte in fusione di alluminio, conferiscono dinamismo e leggerezza al modello Larsen, mentre le accoglienti e comode imbottiture donano morbidezza per un risultato di grande eleganza che rimanda ai modelli americani anni '60. La collezione Larsen comprende divani e pouf in diverse misure oltre a moduli componibili quali elementi, laterali, angoli, terminali, chaise longue, dormeuse, dormeuse angolo e un confortevole day bed. Una poltrona di dimensioni contenute completa la gamma. Comodi poggiatesta e cuscini decorativi in diverse misure sono disponibili come optional. I divani si forniscono con i cuscini di seduta divisi mentre i moduli componibili con i cuscini di seduta unici. La chaise longue e la dormeuse angolo sono disponibili con schienali rettangolari (tipo A) oppure con cuscini-schienale tipo B (da cm.60x60). Il rivestimento in tessuto è completamente sfoderabile. Larsen è attrezzabile con i tavolini Argo, Blog e Jim. **Struttura:** Fusto in legno massello e multistrato, imbottito in poliuretano espanso indeformabile a densità differenziata, molleggio con nastri elastici intrecciati. Prerivestimento con tela di cotone accoppiata con fibra poliestere. Piede a ponte di serie in fusione di alluminio verniciato color bronzo oppure, su richiesta, in versione lucidata. **Imbottiture:** Cuscini di seduta in poliuretano espanso indeformabile a densità differenziata e fibra poliestere. Su richiesta, con supplemento di prezzo, si forniscono i cuscini di seduta nella versione in piuma canalizzata con inserto in poliuretano a densità differenziata. I cuscini-schienale sono in fibra poliestere cardata, canalizzata, con inserto in poliuretano espanso indeformabile; i cuscini-schienale tipo B (cm. 60x60) - disponibili esclusivamente nella chaise longue e nella dormeuse-angolo - sono interamente in piuma canalizzata. I cuscini decorativi e i poggiatesta opzionali sono interamente in piuma. Il Cuscino Rollo per Day bed è in poliuretano e fibra. Tutte le imbottiture sono prerivestite con tela bianca.

Features: The essential design of the frame together with the bridge-shaped feet in aluminium cast give dynamism and lightness to the item Larsen, while comfortable padding lends softness for an elegant result recalling the American models of the '60s. Collection Larsen includes sofas and poufs available in different dimensions, beside sectional modules like elements, side pieces, corners, end pieces, chaise longue, dormeuse, corner dormeuse and a comfortable day bed. A small armchair completes the range. Comfortable lumbar cushions and cushions are available in various sizes as optional. Sofas are delivered with divided seat cushions, while sectional modules are delivered with unique seat cushion. Chaise Longue and Corner Dormeuse are available either with rectangular backrest cushions (type A) or with square backrest cushions type B (cm 60x60). Fabric cover is fully removable. Larsen can be equipped with tables: Argo, Blog and Jim. **Framework:** Frame made of solid and plywood, padded with non-deformable expanded polyurethane of differentiated density, and sprung with interwoven elastic belts. Cotton lining coupled with polyester fibre. Bridge-shaped feet in aluminium cast bronzed painted as standard, or in polished aluminium cast upon request. **Cushion Padding:** Seat cushions in non-deformable expanded polyurethane with differentiated density and polyester fibre. Upon request, and with up charge, seat cushions with canalised feather and polyurethane insert can be provided. Backrest-Cushions in teased and canalised polyester fibre with non-deformable polyurethane insert. Backrest-Cushions type B (cm 60x60) - available by chaise longue and corner dormeuse only- are fully in canalised feather. Optional cushions and lumbar-cushions are entirely in feather. Roll cushion for Day bed is in polyurethane and polyester fibre. All padding is fully lined with white fabric.

Eigenschaften: Minimalistische Linien des Korpus, verbunden mit dem brückenförmigen Fuß in Aluminiumguss, verleihen dem Modell Larsen Dynamismus und Leichtigkeit, während die einladenden und bequemen Polster Weichheit schenken. Das Resultat ist eine hohe Eleganz, die an die amerikanischen Modelle der 60er Jahre erinnert. Die Kollektion Larsen bietet Sofas und Hocker verschiedener Maße und, abgesehen von Zentralelementen, Seitenteilen, Eckteilen, Endelementen, Chaiselongue, Dormeuse, Eckdormeuse, auch ein komfortables Daybed. Ein kleiner Sessel vervollständigt das Angebot. Bequeme Lenden- und Wurfkissen verschiedener Größen sind optional. Die Sitzkissen der Einzelsofas sind immer geteilt, die der Module jedoch durchgehend. Sowohl die Chaiselongue als auch die Eckdormeuse sind mit rechteckigen Rückenissen (Typ A) verfügbar oder mit den großen viereckigen Rückenissen (Typ B 60x60 cm). Stoffbezüge sind komplett abziehbar. Dem Modell Larsen können die Tische Argo, Blog und Jim beigeestellt werden. **Struktur:** Der Korpus besteht aus Massiv- und Mehrschichtholz, gepolstert mit formstabilem Polyurethan unterschiedlicher Dichte und einer Federung mit geflochtenen elastischen Bändern. Unterbezug aus weißem Baumwollstoff mit Polyesterfaser. Brückenförmiger Fuß in bronzefarbenen Aluminiumguss serienmäßig oder, auf Anfrage, poliert. **Polster:** Sitzkissen aus formstabilem Polyurethan unterschiedlicher Dichte und Polyesterfaser. Auf Anfrage, und unter Anrechnung eines Aufpreises, können die Sitzkissen mit Federn, in Kammern gesteppt, und einem Polyurethankern unterschiedlicher Dichte geliefert werden. Die Rückenissenpolsterung ist aus gekämmter und in Kammern gesteppter Polyesterfaser mit einem formstabilen Polyurethankern. Die Rückenissenfüllung, Version B (cm 60x60), - nur bei der Chaiselongue und der Eckdormeuse erhältlich - ist gänzlich aus in Kammern gesteppten Federn. Die optionalen Wurf- und Lendenkissen haben eine reine Federfüllung. Die Nackenrolle des Daybeds ist in Polyurethan und Polyesterfaser. Alle Polster sind mit einem weißen Schonbezug verkleidet.

PIEDE FOOT FUß

Fusione di alluminio verniciato color bronzo (di serie); fusione di alluminio lucidato (su richiesta).
Bronze painted aluminium cast (series); polished cast aluminium (upon request).
Standardausführung in bronzefarbenen Aluminiumguss; Auf Anfrage in Aluminiumguss poliert.

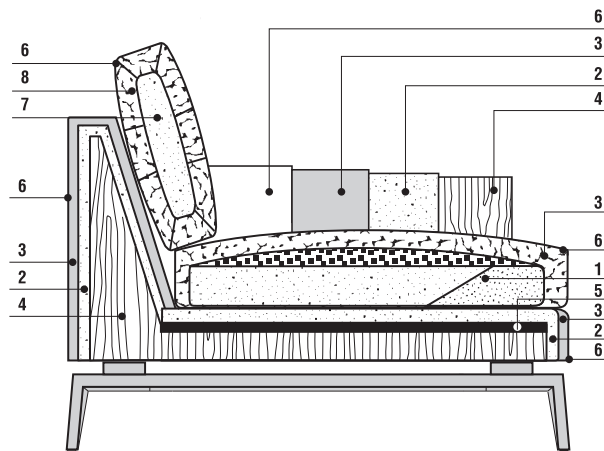
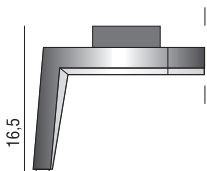

SEZIONE SECTION SEKTION

- 1: Poliuretano a densità differenziata.
Differentiated density polyurethane.
Polyurethan unterschiedlicher Dichte.
- 2: Poliuretano. Polyurethane. Polyurethan.
- 3: Fibra Poliestere. Polyester Fibre.
Polyesterfaser.
- 4: Fusto in legno massello e multistrato.
Frame in solid wood and plywood.
Korpus aus Massivholz, und schichtverleimt.
- 5: Nastri elastici. Elastic belts. Elastische Gurte.
- 6: Fodera in tela. Fabric lining. Schonbezug.
- 7: Inserto in Poliuretano. Polyurethane insert.
Kern aus Polyurethan.
- 8: Fibra Poliestere cardata, canalizzata.
Teased and canalised polyester fibre.
Gekämmte, in Kammern gesteppte Polyesterfaser.

LARSEN VERSIONE A

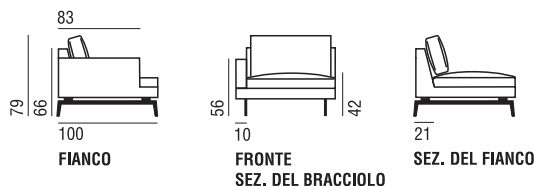

LARSEN VERSIONE B



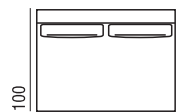

148
ELEMENTO 148
cuscino unico



168
ELEMENTO 168
cuscino unico



195
ELEMENTO 195
cuscino unico



222
ELEMENTO 222
cuscino unico

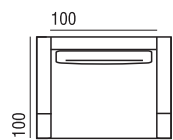

120
LOVE SEAT 120
cuscino unico

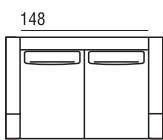

168
DIVANO 168
cuscini divisi

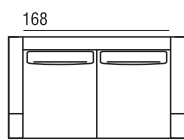

188
DIVANO 188
cuscini divisi

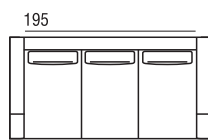

215
DIVANO 215
cuscini divisi

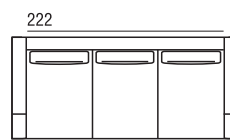

242
DIVANO 242
cuscini divisi

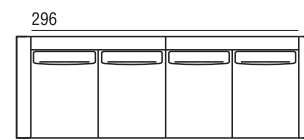

316
DIVANO 316
composto da 2 laterali 158 SX e DX cuscini divisi

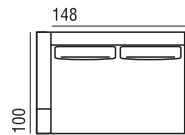

158
LATERALE 158 SX
cuscino unico

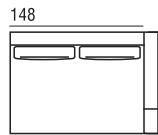

158
LATERALE 158 DX
cuscino unico

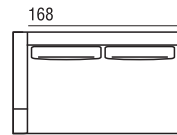

178
LATERALE 178 SX
cuscino unico

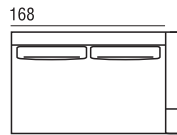

178
LATERALE 178 DX
cuscino unico

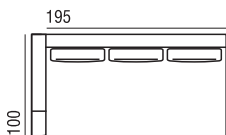

205
LATERALE 205 SX
cuscino unico

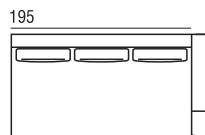

205
LATERALE 205 DX
cuscino unico

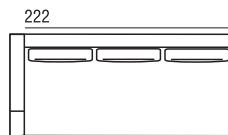

232
LATERALE 232 SX
cuscino unico

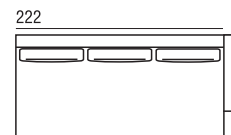

232
LATERALE 232 DX
cuscino unico

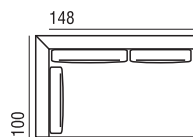

170
ANGOLO 170 SX
cuscino unico

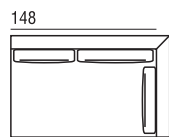

170
ANGOLO 170 DX
cuscino unico

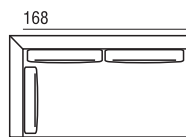

190
ANGOLO 190 SX
cuscino unico

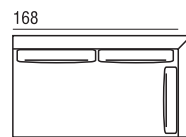

190
ANGOLO 190 DX
cuscino unico

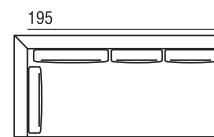

217
ANGOLO 217 SX
cuscino unico

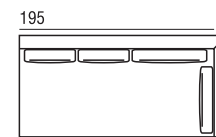

217
ANGOLO 217 DX
cuscino unico

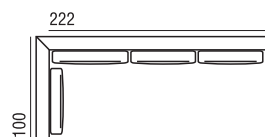

244
ANGOLO 244 SX
cuscino unico

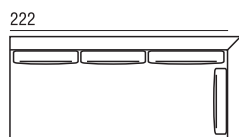

244
ANGOLO 244 DX
cuscino unico

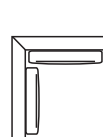

100
ANGOLO 100x100
cuscino unico

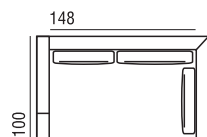

180
ANGOLO LATERALE 180 SX
cuscino unico

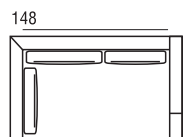

180
ANGOLO LATERALE 180 DX
cuscino unico

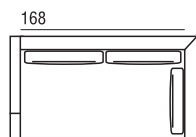

200
ANGOLO LATERALE 200 SX
cuscino unico

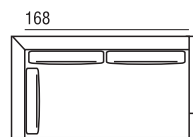

200
ANGOLO LATERALE 200 DX
cuscino unico

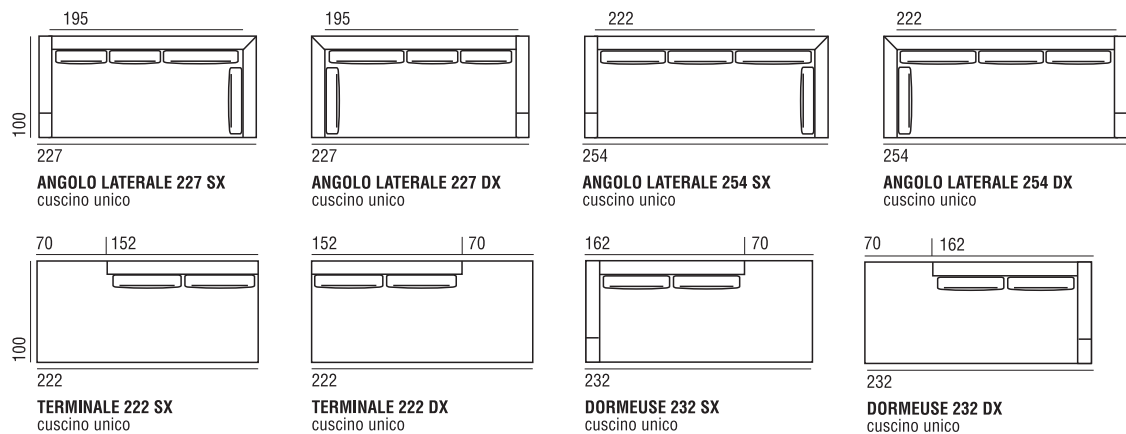

LARSEN VERSIONE A

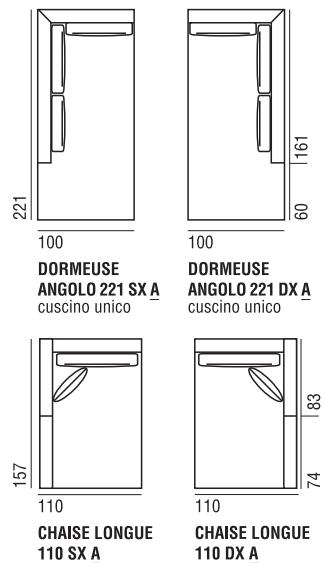

LARSEN VERSIONE B

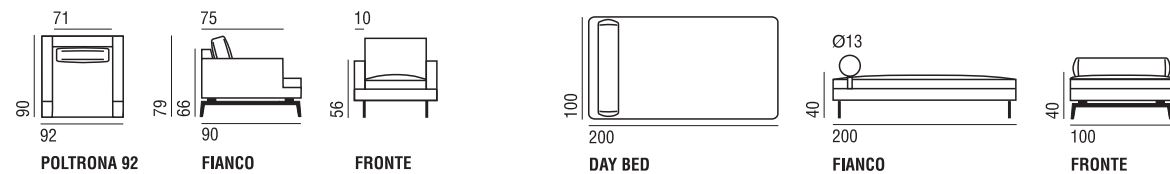
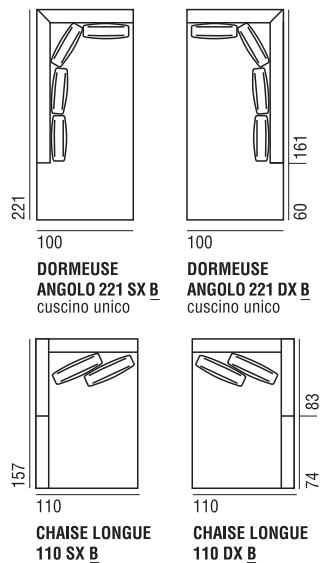

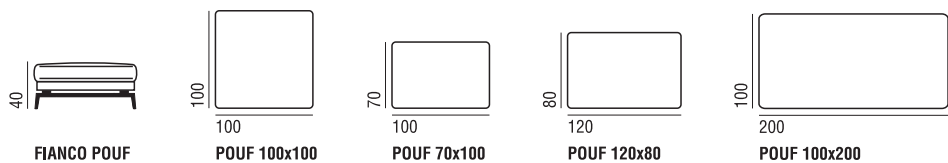

COMPLEMENTI

BLOG TAVOLINO ROTONDO design Lievore Altherr Molina (2006)

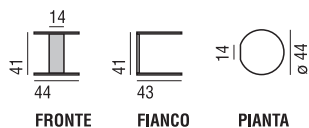

BLOG TAVOLINO RETTANGOLARE design Lievore Altherr Molina (2006)

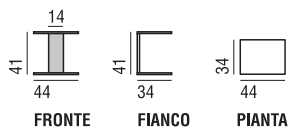

BLOG TAVOLINO XL design Lievore Altherr Molina (2013)



TAVOLINO ARGO design Lievore Altherr Molina (2006)

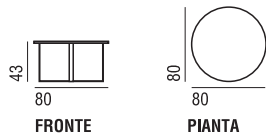

TAVOLINO JIM design Lievore Altherr Molina (2010)

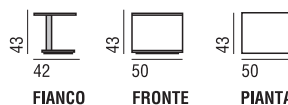

TAVOLINO JULES design Lievore Altherr Molina (2010)

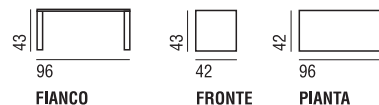

Descrizione composizioni fotografate - Description of the photographed combinations - Beschreibung der gebildeten Zusammenstellungen

Foto pagine - photos at pages - Bilder auf Seiten: 16/17

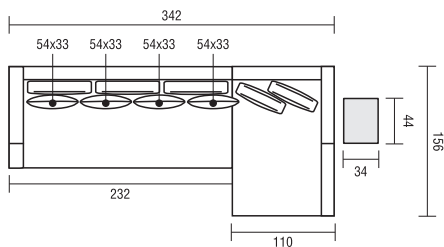

- | | | |
|-------------------------------------|---------------------------------------|--|
| 1 laterale 232 SX | 1 side piece 232 SX | 1 Seitenteil 232 SX |
| 1 chaise longue 110 DX B | 1 chaise longue 110 DX B | 1 Chaiselongue 110 DX B |
| 4 cuscini 54x33 | 4 cushions 54x33 | 4 Wurfkissen 54x33 |
| 1 tavolino Blog rettangolare | 1 Blog rectangular small table | 1 Blog rechteckiger Beistelltisch |

Descrizione composizioni fotografate - Description of the photographed combinations - Beschreibung der gebildeten Zusammenstellungen

Foto pagina - photo at page - Bild auf Seiten: 19

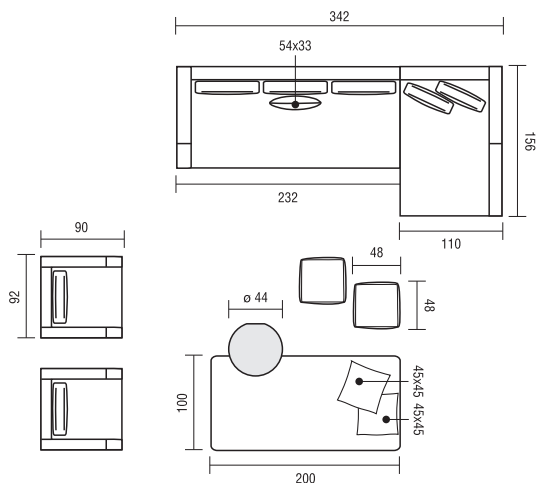

- | | | |
|--------------------------|--------------------------|-----------------------------|
| 1 laterale 232 SX | 1 side piece 232 SX | 1 Seitenteil 232 SX |
| 1 chaise longue 110 DX B | 1 chaise longue 110 DX B | 1 Chaiselongue 110 DX B |
| 1 pouf 100x200 | 1 pouf 100x200 | 1 Hocker 100x200 |
| 2 pouf Zoe Cubo | 2 poufs Zoe Cubo | 2 Hocker Zoe Cubo |
| 2 poltrone 92 | 2 armchairs 92 | 2 Sessel 92 |
| 1 cuscino 54x33 | 1 cushion 54x33 | 1 Wurfkissen 54x33 |
| 2 cuscini 45x45 | 2 cushions 45x45 | 2 Wurfkissen 45x45 |
| 1 tavolino Blog rotondo | 1 Blog round small table | 1 Blog runder Beistelltisch |

Foto pagine - photos at pages - Bilder auf Seiten: 20/21

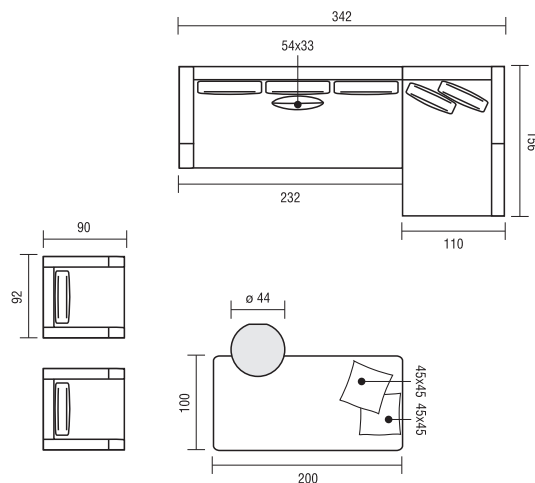

- | | | |
|--------------------------|--------------------------|-----------------------------|
| 1 laterale 232 SX | 1 side piece 232 SX | 1 Seitenteil 232 SX |
| 1 chaise longue 110 DX B | 1 chaise longue 110 DX B | 1 Chaiselongue 110 DX B |
| 1 pouf 100x200 | 1 pouf 100x200 | 1 Hocker 100x200 |
| 2 poltrone 92 | 2 armchairs 92 | 2 Sessel 92 |
| 1 cuscino 54x33 | 1 cushion 54x33 | 1 Wurfkissen 54x33 |
| 2 cuscini 45x45 | 2 cushions 45x45 | 2 Wurfkissen 45x45 |
| 1 tavolino Blog rotondo | 1 Blog round small table | 1 Blog runder Beistelltisch |

Foto pagine - photos at pages - Bilder auf Seiten: 22/23

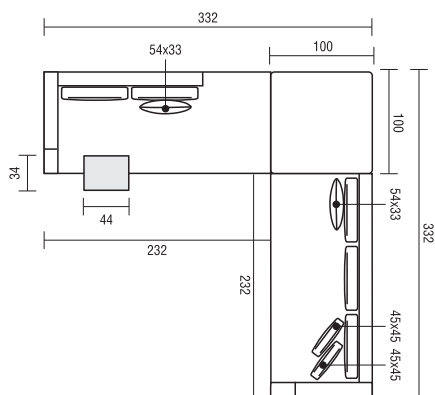

- | | | |
|------------------------------|--------------------------------|-----------------------------------|
| 1 dormeuse 232 SX | 1 dormeuse 232 SX | 1 Dormeuse 232 SX |
| 1 pouf 100x100 | 1 pouf 100x100 | 1 Hocker 100x100 |
| 1 laterale 232 DX | 1 side piece 232 DX | 1 Seitenteil 232 DX |
| 2 cuscini 45x45 | 2 cushions 45x45 | 2 Wurfkissen 45x45 |
| 2 cuscini 54x33 | 2 cushions 54x33 | 2 Wurfkissen 54x33 |
| 1 tavolino Blog rettangolare | 1 Blog rectangular small table | 1 Blog rechteckiger Beistelltisch |

Foto pagine - photos at pages - Bilder auf Seiten: 24/25

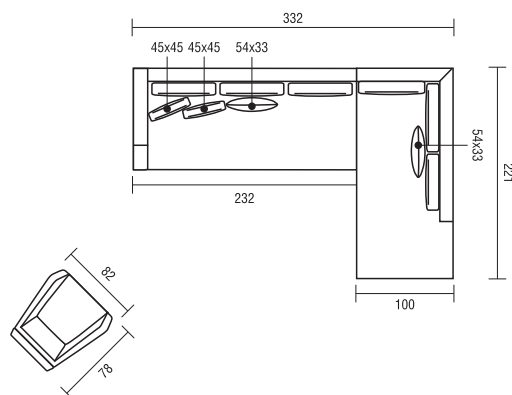

- | | | |
|-------------------------|--------------------------------|----------------------|
| 1 laterale 232 SX | 1 side piece 232 SX | 1 Seitenteil 232 SX |
| 1 dormeuse angolo 221 A | 1 corner dormeuse 221 A | 1 Eckdormeuse 221 A |
| 2 cuscini 45x45 | 2 cushions 45x45 | 2 Wurfkissen 45x45 |
| 2 cuscini 54x33 | 2 cushions 54x33 | 2 Wurfkissen 54x33 |
| 1 poltrona Sillón alta | 1 armchair Sillón high version | 1 Sillón hohe Sessel |