

CADRE SWIVEL SEATING  
LIST PRICES EFFECTIVE  
FEBRUARY 1, 2024

CADRE  
SWIVEL  
SEATING



STATE OF NORTH CAROLINA

2 0 2 4



---

|  |   |  |   |
|--|---|--|---|
| <b>Mailing Address:</b><br><b>HBF</b><br>PO Box 8<br>Hickory NC 28603-0008 | <b>Shipping Address:</b><br><b>HBF</b><br>900 - 12th Street Drive NW<br>Hickory NC 28601-4763 | <b>Contact:</b><br>Phone: 1.855.HBF.2020<br>828.328.2064<br>Fax: 828.485.2690<br>Info: hbfservice@hbf.com<br>www.hbf.com | <b>Order Processing:</b><br>Phone: 1.855.HBF.2020<br>828.328.2064<br>Fax: 828.485.2690<br>hbforders@hbf.com |
|--|---|--|---|

---

| GENERAL INFORMATION                               | PAGE |
|---|------|
| ANSI/BIFMA e3-2014e Furniture Sustainability..... | 5    |
| Casters .....                                     | 9    |
| COM Ordering Requirements.....                    | 3    |
| Combinations of Upholstery Applications .....     | 4    |
| Dimension Guide .....                             | 5    |
| GSA .....   | 6    |
| HBF Textiles Graded Product .....                 | 8    |
| High Performance Products .....                   | 6    |
| Indoor Advantage™ Gold Certified .....            | 5    |
| Product Material Options .....                    | 7    |
| Seating Ordering Procedure .....                  | 2    |
| Special Code Compliance – CAL 117.....            | 4    |
| Spring Down Cushions.....                         | 6    |
| Statement of Line.....                            | 11   |
| Veneer Options.....                               | 6    |
| Yardage Requirements.....                         | 2    |
| <br>SWIVEL SEATING                                |      |
| Cadre .....                                       | 10   |



Coverings

All upholstered items may be ordered using HBF Textiles, HBF Leathers, or coverings provided by the customer. Prices listed as COM refer to Customer's Own Material, which includes textiles and leather. Prices listed as GRADE refer to HBF Textiles and/or HBF Leather.

Yardage requirements shown in the price list are based on non-directional 54" wide material. The following conversion chart should be used to determine yardage requirements when COM textile is 54" wide or less and/or has a repeat of 2" or more. Add together the vertical and horizontal repeat to determine which column should be used as a reference.

Table with 9 columns: Fabric Width, Plain Fabric, 2"-10" Repeat, 11"-20" Repeat, 21"-25" Repeat, 26"-30" Repeat, 31"-35" Repeat, 36"-40" Repeat, 41"-45" Repeat. Rows show percentage increments for various fabric widths.

To determine the possibility of reduced yardage requirements for orders of thirty (30) or more units, please contact The HBF Client Experience Team. HBF reserves the right to request additional yardage of COM at customer expense based on repeat and/or pattern size, and number of rolls.

All COM's must be approved for application before the purchase order is submitted to HBF. Please contact The HBF Client Experience Team at hbfservice@hbf.com to verify that your COM fabric has been approved. If it has not, please request COM approval testing via www.hbf.com under COM Request. Failure to submit a COM for testing may result in additional expenses or rejection of COM. For any repeat and/or pattern size not listed, please contact The HBF Client Experience Team for a yardage requirement quotation.

HBF cannot be held responsible for performance, color accuracy, or weaving of COM materials. All responsibility for COM shipments is between the purchaser and the textile/leather source. HBF reserves the right to reject any COM. HBF assumes no responsibility for suitability or wearability of COM. Difficult COM may be subject to additional charge if additional labor costs are incurred. HBF assumes no responsibility for the flame retardance of any COM. Customers are solely responsible for making sure that COM complies with all applicable codes and regulations. Orders specifying COM will not be scheduled for production until all approved COM(s) are received by HBF. To ensure proper COM expediting, please tag fabric/leather roll(s) with the following information: 1. Purchasing dealer name and purchase order number 2. HBF acknowledgment number, if available 3. Other pertinent information which will enable proper COM identification.

When sending COM leather for use on one of our upholstered pieces, please send eighteen (18) square feet of leather for each yard of 54" plain fabric required for that item.



Coverings (Continued)

**COM ORDERING REQUIREMENTS:**

**Prior to acceptance of order specifying COM, a memo sample must be submitted to HBF for determination of suitability. All COM's must be rolled separately, on individual tubes. Multiple materials rolled on the same tube will not be accepted.**

For ease of expediting your COM order, we require the following information:

- |   |                              |
|---|------------------------------|
| 1. Material description                     | <b>Shipping Address:</b> HBF |
| 2. Material source                          | 900 12th Street Drive NW     |
| 3. Order line, product name or number       | Hickory, NC 28601-4763       |
| 4. Material color                           |                              |
| 5. A swatch of the covering                 |                              |
| 6. Special application instructions, if any |                              |

If COM is of a type requiring choices of seam placement, face side, position of design or repeat; these instructions must be clearly stated on the original order.

HBF cannot be held responsible for performance, color accuracy, or weaving of COM materials. All responsibility for COM shipments is between the purchaser and the textile/leather source.

HBF reserves the right to reject any COM. HBF assumes no responsibility for suitability or wearability of COM. Difficult COM may be subject to additional charge if additional labor costs are incurred.

HBF assumes no responsibility for the flame retardance of any COM. Customers are solely responsible for making sure that COM complies with all applicable codes and regulations.

Orders specifying COM will not be scheduled for production until all approved COM is received by HBF.

To ensure proper COM expediting, please tag textile/leather with the following information:

1. Purchasing dealer name and purchase order number
2. HBF acknowledgement number, if available
3. Other pertinent information which will enable proper COM identification



---

**Combination of Upholstery Applications**

All seating ordered with combination upholstery application (fabric, leather) that **is not** offered as standard is subject to a **\$103 List Upholstery upcharge** and will be entered and processed as a special model, in addition to the following pricing conditions:

1. Combinations using HBF Textiles and COM will be priced at the COM price. The cost of the portion of the HBF Textiles used, will be entered as a miscellaneous charge on the furniture order.
2. Combinations using HBF Textiles and HBF Leathers, or COM and HBF Leathers, will be priced at the appropriate Leather I-V price.
3. Combinations using two HBF Textiles will be invoiced at higher grade price.
4. When specifying combination of upholstery applications, a sketch indicating placement of textiles and direction of applications must accompany the purchase order.

---

**Special Code Compliance**

**California #117-2013**

Unless otherwise specified, foam used in all HBF seating products complies with these guidelines.

**Boston Fire Code**

**New York Port Authority**

Please contact the HBF Client Experience Team if compliance is required for these special codes.

---

**ANSI/BIFMA e3-2014e  
LEVEL® Furniture  
Sustainability Standard  
Certification**

A majority of HBF’s products have met the necessary qualifications to achieve LEVEL® certification. LEVEL® is the multi-attribute sustainability certification based on the ANSI/BIFMA e3 Furniture Sustainability Standard. The standard and certification were created to deliver the most open and transparent means of evaluating and communicating the environmental and social impacts of furniture products in the built environment. Taking into account a company’s social actions, energy usage, material selection and human and ecosystem health impacts, LEVEL® addresses how a product is sustainable from multiple perspectives. The organization, facilities, and products are audited on an annual basis to ensure ongoing compliance and improvement.

With LEVEL®, customers can make informed choices about sustainable commercial office furniture. The LEVEL® mark identifies that a product has been vetted by an independent third party certifier and its numeric marking of 1, 2, or 3 indicates the threshold of certification the product has achieved. A majority of HBF’s seating, occasional tables, and conference lines are LEVEL® certified. Please download the certificates from our product pages for the complete details. For more information about the ANSI/BIFMA LEVEL® standard, visit [www.levelcertified.org](http://www.levelcertified.org).

**ANSI/BIFMA Performance  
Standards**

Our seating products meet or exceed ANSI/BIFMA weight performance standards of 275 lbs. (124.7 kg.) unless otherwise noted.

**Indoor Advantage™  
Gold certified**

All HBF seating products are Indoor Advantage™ Gold Certified.

SCS Global Services, a reputable third-party certification and assessment body of environmental, sustainability and safety claims since 1984, has developed internationally recognized standards and certification programs to assist businesses with improving their environmental efforts, social accountability and product performance.

The advantages of holding Indoor Air Quality certification are substantial: in addition to improving indoor working environments and meeting qualifications for the LEED-CI EQ 4.5 credit for office furniture as well as the BIFMA Standard for Low-Emitting Office Furniture Systems & Seating M-7.1, there is the added assurance of knowing that the company’s entire breadth of products is held to such rigorous standards.

For more information regarding Indoor Advantage™, please visit: <http://www.scsglobalservices.com>.

Please contact the HBF Client Experience Team for pricing and lead time information.

**Dimension Guide**

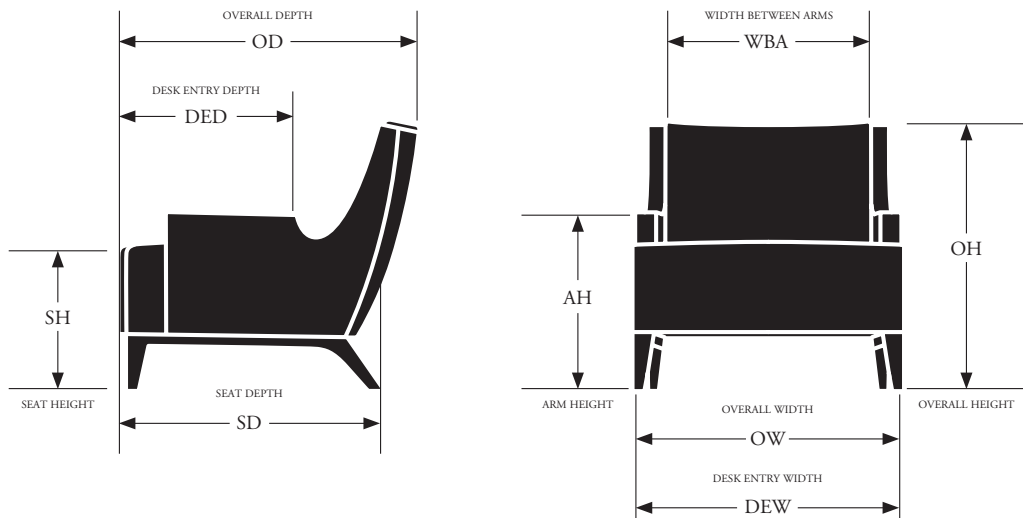



GSA/Federal Contract Information:

GSA Contract Number 47QSMA22D08P9

Model numbers identified with the following verbiage “When purchased separately without a configurable TAA compliant end product, not on GSA contract” is to mean that these configurable parts or components:

- Have no functionality or capability without being integrated into an end product; and
- Are considered **Open Market** if purchased without a configurable TAA compliant end product.

**HBF High Performance Products**

HBF and HBF Textiles have long been leaders in contract furnishings and known for industry-leading product design coupled with the highest quality construction, comfort and aesthetic beauty.

Now these same principals are the cornerstones of HBF Healthcare high performance products. We have consulted with healthcare designers and clients to provide products and options for interiors that will provide quality sustainable design solutions for the future. These effective solutions will address the unique interactions required by any high-use facility. Visit [www.hbf.com](http://www.hbf.com) for additional high performance product information.

Seating Product High Performance Options:

- Guest and Lounge Seating
- Arm Caps
- Moisture Barrier
- Wipe Out - Clean Out
- Tandem Seating
- Wall Saver Legs
- Replaceable Components
- Upholstery Products from HBF Textiles

**Spring Down Cushions**

Optional spring down cushions are available on most loose cushion HBF lounge seating. List upcharges are:

|          |       |
|----------|-------|
| Chair    | \$108 |
| Loveseat | \$194 |
| Sofa     | \$297 |

**Veneer and Finishes**

Wood owes its inherent beauty to variations in color, grain, and texture; therefore, these variations are not considered defects. Due to the natural color and grain variances of wood substance the final finish color, texture and grain may vary from one furniture piece to another even though they are finished at the same time. Exposure to light and the aging process will cause changes in surface color of natural wood products. Light finishes on wood products do not mask the natural characteristics of wood. HBF does not guarantee the exact matching of grain, pattern and color.

An upcharge of **5% Net** COM per seating unit, with a minimum upcharge of **\$500 Net** per order, will apply for any custom wood finish.

Refer to the following page for product material options.



**POWDER COAT:**

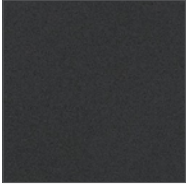

P8X  
Solar Black

**METAL:**



PAL  
Polished Aluminum

Screen images are intended as a guide only and should not be regarded as absolutely correct.  
For exact color/texture, please visit [www.hbf.com](http://www.hbf.com) to request an actual sample.





| Grade A                                    | Grade B                       | Grade C   | Grade D   | Grade E             | Grade F  |
|--|-------------------------------|---|---|---------------------|--|
| Blink<br>Denim Wash*<br>Walkabout<br>Zippy | Look-see<br>Remember<br>Rush* | Caddy Corner*<br>Checkmate<br>Cuddle Up<br>Picnic Plaid<br>Upbeat | Chenille Striae<br>Crumpled Paper<br>Dot Grid<br>Habu<br>Poppy<br>Skim Coat | Fourfold*<br>Uptown | All Terrain<br>Bunny<br>Cloverleaf<br>Comfort Zone<br>Happy Camper<br>Here & There<br>Knitwork<br>Laugh Lines<br>Moody Moss<br>Notable Grain<br>Sherpa<br>Well-Loved |

| Grade G  | Grade H  | Grade J  | Grade K  | Grade L  | Grade M                                       |
|--|--|--|--|--|---|
| Beetle<br>Curtain Wall<br>Dashing<br>Equation*<br>Folded Lines<br>High Rise<br>Honest*<br>Inherent<br>Matriarch<br>Pebbled<br>Scribble XS<br>Stardust<br>Upscale | Air Mail*<br>Captain Bubble<br>Crafted Felt<br>Chubby Baby<br>Intersection<br>Lawn Chair<br>Madam Dottie<br>Soft Angles 2.0<br>Upstart<br>Uptick | Abito<br>Argyle Boucle<br>Belgian Meadow<br>Brushed Canvas<br>Digital Bloom 2.0<br>Enriched Boucle<br>Glint<br>Lava Rock<br>Quill<br>Scribble XL<br>Sir Stripe-a-lot<br>Tattoo Toile<br>Tessellations<br>Tête-à-Tête<br>Tickled Herring<br>Twist | Afghan<br>Cherished Knit<br>Complex<br>Crosstweed<br>Double Stitch<br>Gather<br>Grateful Grid<br>Heartfelt<br>Merci Boucle<br>Moving Blanket<br>Moving Forward<br>Night Earth<br>Pepper Blend<br>Polygone<br>Quilted Comfort<br>Sideways<br>Sister Solid | Agate Stripe<br>Goosebumps<br>Hipster<br>Landscape Blur<br>Ms. Quilty 2.0<br>Smart*<br>Sweater<br>Velvet Mix<br>Woven Memory | Crafted Cloud<br>Eccentric<br>Flirt<br>Poodle |

| Leather I | Leather II | Leather III | Leather IV | Leather V | Leather VI                   |
|-----------|------------|-------------|------------|-----------|------------------------------|
| Clutch    | Vivace II  | Aviator     | Free Way   | Wild West | Modern Patina<br>Upper Crust |

\*Some or all colors to be discontinued in 2024

**Casters**

Double wheel medium casters (A) are standard on Cadre Series swivel products.

Optional soft wheel casters (B) are available on Cadre Series swivel products.  
This must be specified on product orders.

*(A)  
Double Wheel  
Wheel Diameter 2"*



*(B)  
Soft Wheel  
Wheel Diameter 2"*





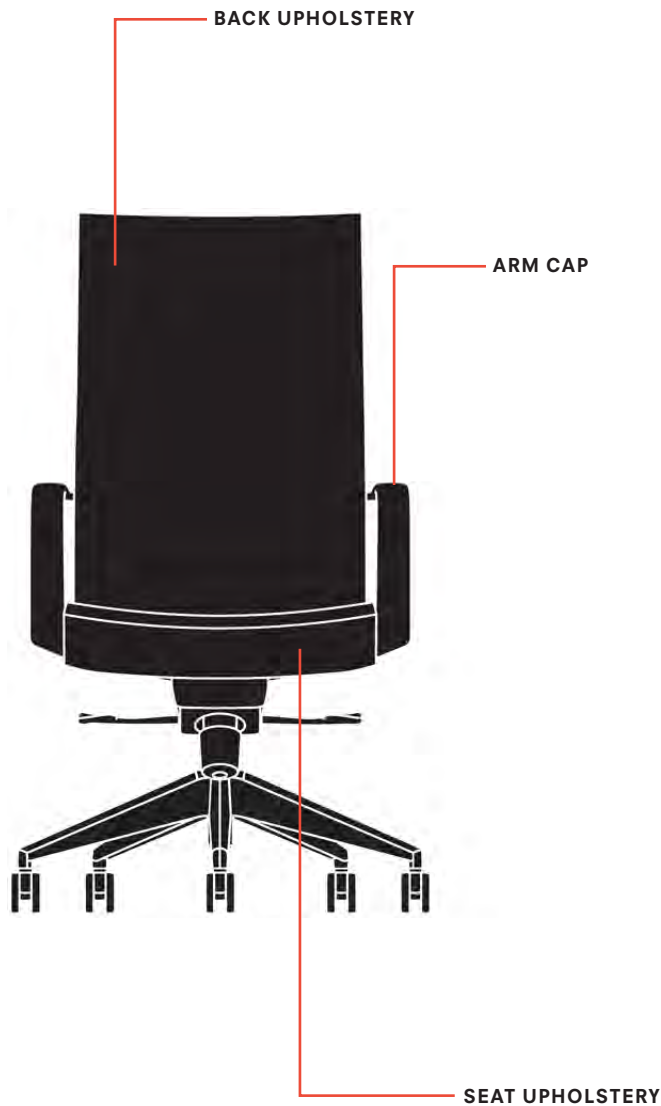

## Cadre Series Specifications

|                           |  |
|---------------------------|--|
| <b>Collection Details</b> | Mid Back vs High Back<br>Plain or Channel Stitched seat and inside back  |
| <b>Adjustments</b>        | Knee tilt adjustment and pneumatic seat height and are standard on Cadre chairs with arm that wraps around the back of the chair. Synchronized seat and back movement are standard on all other chairs.<br>Synchro Tilt vs Knee Tilt |
| <b>Bases</b>              | Finish for five-prong bases is standard in <b>either</b> black metal or polished aluminum, as listed in the specification notes for each model.  |
| <b>Casters</b>            | Double wheel casters are standard on all chairs. Optional soft wheel casters available.  |
| <b>Arms</b>               | Non-wraparound vs wraparound arm frame<br>Finish for arms is standard in <b>either</b> black metal or polished aluminum, as listed in the specification notes for each model.<br>Urethane vs upholstered arm cap                     |









**CADRE MID BACK**

|  |   |   |  |
|--|---|---|--|
| <p><b>MID BACK SWIVEL CHAIR</b></p> <p>Synchro Tilt, Upholstered Arm Cap, Polished Arm<br/>HST222-511 Pg 20</p>  <p>OH 35½-39½ SD 19<br/>OW 24 AH 26½-30½<br/>OD 26 WBA 19<br/>SH* 18½-22½</p> <p><b>POLISHED WITH URETHANE ARM CAP</b><br/>HST222-611 Pg 36</p> <p><b>SOLAR BLACK WITH UPHOLSTERED ARM CAP</b><br/>HST222-011 Pg 12</p> <p><b>SOLAR BLACK WITH URETHANE ARM CAP</b><br/>HST222-111 Pg 28</p> | <p><b>MID BACK SWIVEL CHAIR</b></p> <p>Knee Tilt, Upholstered Arm Cap, Polished Wrap Around Arm<br/>HST222-531 Pg 22</p>  <p>OH 35½-39½ SD 19<br/>OW 24 AH 26½-30½<br/>OD 26 WBA 19<br/>SH* 18½-22½</p> <p><b>POLISHED WITH URETHANE ARM CAP</b><br/>HST222-631 Pg 38</p> <p><b>SOLAR BLACK WITH UPHOLSTERED ARM CAP</b><br/>HST222-031 Pg 14</p> <p><b>SOLAR BLACK WITH URETHANE ARM CAP</b><br/>HST222-131 Pg 30</p> | <p><b>MID BACK CHANNEL STITCHED SWIVEL CHAIR</b></p> <p>Synchro Tilt, Upholstered Arm Cap, Polished Arm<br/>HST222-551 Pg 24</p>  <p>OH 35½-39½ SD 19<br/>OW 24 AH 26½-30½<br/>OD 26 WBA 19<br/>SH* 18½-22½</p> <p><b>POLISHED WITH URETHANE ARM CAP</b><br/>HST222-651 Pg 40</p> <p><b>SOLAR BLACK WITH UPHOLSTERED ARM CAP</b><br/>HST222-051 Pg 16</p> <p><b>SOLAR BLACK WITH URETHANE ARM CAP</b><br/>HST222-151 Pg 32</p> | <p><b>MID BACK CHANNEL STITCHED SWIVEL CHAIR</b></p> <p>Knee Tilt, Upholstered Arm Cap, Polished Wrap Around Arm<br/>HST222-571 Pg 26</p>  <p>OH 35½-39½ SD 19<br/>OW 24 AH 26½-30½<br/>OD 26 WBA 19<br/>SH* 18½-22½</p> <p><b>POLISHED WITH URETHANE ARM CAP</b><br/>HST222-671 Pg 42</p> <p><b>SOLAR BLACK WITH UPHOLSTERED ARM CAP</b><br/>HST222-071 Pg 18</p> <p><b>SOLAR BLACK WITH URETHANE ARM CAP</b><br/>HST222-171 Pg 34</p> |
|--|---|---|--|

**CADRE HIGH BACK**

|   |  |  |  |
|---|--|--|--|
| <p><b>HIGH BACK SWIVEL CHAIR</b></p> <p>Synchro Tilt, Upholstered Arm Cap, Polished Arm<br/>HST222-521 Pg 21</p>  <p>OH 41½-44½ SD 19<br/>OW 24 AH 26½-30½<br/>OD 26 WBA 19<br/>SH* 18½-22½</p> <p><b>POLISHED WITH URETHANE ARM CAP</b><br/>HST222-621 Pg 37</p> <p><b>SOLAR BLACK WITH UPHOLSTERED ARM CAP</b><br/>HST222-021 Pg 13</p> <p><b>SOLAR BLACK WITH URETHANE ARM CAP</b><br/>HST222-121 Pg 29</p> | <p><b>HIGH BACK SWIVEL CHAIR</b></p> <p>Knee Tilt, Upholstered Arm Cap, Polished Wrap Around Arm<br/>HST222-541 Pg 23</p>  <p>OH 41½-44½ SD 19<br/>OW 24 AH 26½-30½<br/>OD 26 WBA 19<br/>SH* 18½-22½</p> <p><b>POLISHED WITH URETHANE ARM CAP</b><br/>HST222-641 Pg 39</p> <p><b>SOLAR BLACK WITH UPHOLSTERED ARM CAP</b><br/>HST222-041 Pg 15</p> <p><b>SOLAR BLACK WITH URETHANE ARM CAP</b><br/>HST222-141 Pg 31</p> | <p><b>HIGH BACK CHANNEL STITCHED SWIVEL CHAIR</b></p> <p>Synchro Tilt, Upholstered Arm Cap, Polished Arm<br/>HST222-561 Pg 25</p>  <p>OH 41½-44½ SD 19<br/>OW 24 AH 26½-30½<br/>OD 26 WBA 19<br/>SH* 18½-22½</p> <p><b>POLISHED WITH URETHANE ARM CAP</b><br/>HST222-661 Pg 41</p> <p><b>SOLAR BLACK WITH UPHOLSTERED ARM CAP</b><br/>HST222-061 Pg 17</p> <p><b>SOLAR BLACK WITH URETHANE ARM CAP</b><br/>HST222-161 Pg 33</p> | <p><b>HIGH BACK CHANNEL STITCHED SWIVEL CHAIR</b></p> <p>Synchro Tilt, Upholstered Arm Cap, Polished Wrap Around Arm<br/>HST222-581 Pg 27</p>  <p>OH 41½-44½ SD 19<br/>OW 24 AH 26½-30½<br/>OD 26 WBA 19<br/>SH* 18½-22½</p> <p><b>POLISHED WITH URETHANE ARM CAP</b><br/>HST222-681 Pg 43</p> <p><b>SOLAR BLACK WITH UPHOLSTERED ARM CAP</b><br/>HST222-081 Pg 19</p> <p><b>SOLAR BLACK WITH URETHANE ARM CAP</b><br/>HST222-181 Pg 35</p> |
|---|--|--|--|

**DIMENSIONS**

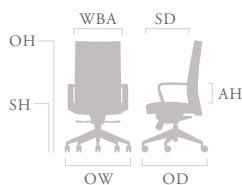

- OH Overall Height
- OW Overall Width
- OD Overall Depth
- SH\* Seat Height
- SH\* Seat Depth
- AH Arm Height
- WBA Width Between Arms

All dimensions in inches.

\*Reflects the nominal seat height to the top of cushion welt.

\*Arm and base metal finishing will always match.





Dimensions

Cadre HST222-011



|    |         |     |         |
|----|---------|-----|---------|
| OH | 35½-39½ | AH  | 26½-30½ |
| OW | 24      | WBA | 19      |
| OD | 26      | DED |         |
| SH | 18½-22½ | DEW |         |
| SD | 19      | R   |         |

|                 |      |
|-----------------|------|
| Shipping Weight | 66   |
| Cube            | 20.4 |

Mid Back | Upholstered Back and Seat | Black Arm with Upholstered Arm Cap | Five-Prong Black Metal Base |

Synchronized Adjustments | Double Wheel Casters

ANSI/BIFMA LEVEL® Furniture Sustainability Standard certified  
Indoor Advantage™ certified

**Pricing for Single Fabric Placement:**

**Upholstery:**

|             |      |
|-------------|------|
| COM/COL     | 2615 |
| Grade A     | 2560 |
| Grade B     | 2590 |
| Grade C     | 2615 |
| Grade D     | 2645 |
| Grade E     | 2670 |
| Grade F     | 2705 |
| Grade G     | 2745 |
| Grade H     | 2785 |
| Grade J     | 2810 |
| Grade K     | 2865 |
| Grade L     | 2950 |
| Grade M     | 3060 |
| Leather I   | 3250 |
| Leather II  | 3450 |
| Leather III | 3650 |
| Leather IV  | 3850 |
| Leather V   | 4050 |
| Leather VI  | 4250 |

**Upholstery Requires:**

|          |    |         |
|----------|----|---------|
| Fabric:  | 2½ | Yards   |
| Leather: | 45 | Sq. Ft. |

**Pricing for Multiple Fabric Placement:**

*(To Calculate, Begin with Base Price and add Upcharges)*

**Back Upholstery:**

|             |     |
|-------------|-----|
| COM/COL     | 30  |
| Grade A     | 10  |
| Grade B     | 20  |
| Grade C     | 30  |
| Grade D     | 45  |
| Grade E     | 55  |
| Grade F     | 65  |
| Grade G     | 85  |
| Grade H     | 100 |
| Grade J     | 110 |
| Grade K     | 130 |
| Grade L     | 165 |
| Grade M     | 210 |
| Leather I   | 285 |
| Leather II  | 365 |
| Leather III | 445 |
| Leather IV  | 525 |
| Leather V   | 605 |
| Leather VI  | 685 |

**Upholstery Requires (Per Application):**

|          |    |         |
|----------|----|---------|
| Fabric:  | 1  | Yard    |
| Leather: | 18 | Sq. Ft. |

**Arm Upholstery:**

|             |     |
|-------------|-----|
| COM/COL     | 20  |
| Grade A     | 5   |
| Grade B     | 15  |
| Grade C     | 20  |
| Grade D     | 25  |
| Grade E     | 30  |
| Grade F     | 35  |
| Grade G     | 45  |
| Grade H     | 50  |
| Grade J     | 55  |
| Grade K     | 70  |
| Grade L     | 85  |
| Grade M     | 105 |
| Leather I   | 145 |
| Leather II  | 185 |
| Leather III | 225 |
| Leather IV  | 265 |
| Leather V   | 305 |
| Leather VI  | 345 |

**Upholstery Requires (Per Application):**

|          |   |         |
|----------|---|---------|
| Fabric:  | ½ | Yard    |
| Leather: | 9 | Sq. Ft. |

**Seat Upholstery:**

|             |     |
|-------------|-----|
| COM/COL     | 30  |
| Grade A     | 10  |
| Grade B     | 20  |
| Grade C     | 30  |
| Grade D     | 45  |
| Grade E     | 55  |
| Grade F     | 65  |
| Grade G     | 85  |
| Grade H     | 100 |
| Grade J     | 110 |
| Grade K     | 130 |
| Grade L     | 165 |
| Grade M     | 210 |
| Leather I   | 285 |
| Leather II  | 365 |
| Leather III | 445 |
| Leather IV  | 525 |
| Leather V   | 605 |
| Leather VI  | 685 |

**Upholstery Requires (Per Application):**

|          |    |         |
|----------|----|---------|
| Fabric:  | 1  | Yard    |
| Leather: | 18 | Sq. Ft. |

Base Price: 2535

**Total Required**

**Upholstery:** Fabric: 2½ Yards  
Leather: 45 Sq. Ft.

PLEASE SPECIFY THE FOLLOWING TO ORDER:

|                     |  |   |  |   |  |
|---------------------|--|---|--|---|--|
| <p>MODEL NUMBER</p> | <p>TEXTILES</p> <p>Indicate fabric choice for:</p> <p>Back upholstery</p> <p><i>See options for fabrics at www.hbftextiles.com</i></p> | <p>TEXTILES</p> <p>Indicate fabric choice for:</p> <p>Arm upholstery</p> <p><i>See options for fabrics at www.hbftextiles.com</i></p> | <p>TEXTILES</p> <p>Indicate fabric choice for:</p> <p>Seat upholstery</p> <p><i>See options for fabrics at www.hbftextiles.com</i></p> | <p>FLAMMABILITY</p> <p>Indicate flammability:</p> <p><b>U</b> = Cal 117</p> | <p>CASTER</p> <p><b>DWCM</b> = Double Wheel - Medium Casters</p> <p><b>DWCS</b> = Double Wheel - Soft Casters +\$106</p> |
|---------------------|--|---|--|---|--|

HST222-011.BackFabric.ArmFabric.SeatFabric.Flammability.Caster Example: HST222-011.950-88.950-88.950-88.U.DWCM



Dimensions

Cadre HST222-021



|    |         |     |         |
|----|---------|-----|---------|
| OH | 41½-44½ | AH  | 26½-30½ |
| OW | 24      | WBA | 19      |
| OD | 26      | DED |         |
| SH | 18½-22½ | DEW |         |
| SD | 19      | R   |         |

|                 |      |
|-----------------|------|
| Shipping Weight | 66   |
| Cube            | 22.5 |

High Back | Upholstered Back and Seat | Black Arm with Upholstered Arm Cap | Five-Prong Black Metal Base |

Synchronized Adjustments | Double Wheel Casters

ANSI/BIFMA LEVEL® Furniture Sustainability Standard certified  
Indoor Advantage™ certified

**Pricing for Single Fabric Placement:**

**Upholstery:**

|             |      |
|-------------|------|
| COM/COL     | 2955 |
| Grade A     | 2890 |
| Grade B     | 2925 |
| Grade C     | 2955 |
| Grade D     | 2985 |
| Grade E     | 3015 |
| Grade F     | 3050 |
| Grade G     | 3095 |
| Grade H     | 3135 |
| Grade J     | 3165 |
| Grade K     | 3230 |
| Grade L     | 3320 |
| Grade M     | 3440 |
| Leather I   | 3650 |
| Leather II  | 3870 |
| Leather III | 4090 |
| Leather IV  | 4310 |
| Leather V   | 4530 |
| Leather VI  | 4750 |

**Upholstery Requires:**

Fabric: 2¾ Yards  
Leather: 49½ Sq. Ft.

**Pricing for Multiple Fabric Placement:**

*(To Calculate, Begin with Base Price and add Upcharges)*

**Back Upholstery:**

|             |     |
|-------------|-----|
| COM/COL     | 45  |
| Grade A     | 15  |
| Grade B     | 30  |
| Grade C     | 45  |
| Grade D     | 55  |
| Grade E     | 70  |
| Grade F     | 90  |
| Grade G     | 105 |
| Grade H     | 125 |
| Grade J     | 140 |
| Grade K     | 170 |
| Grade L     | 210 |
| Grade M     | 265 |
| Leather I   | 360 |
| Leather II  | 460 |
| Leather III | 560 |
| Leather IV  | 660 |
| Leather V   | 760 |
| Leather VI  | 860 |

**Upholstery Requires (Per Application):**

Fabric: 1¼ Yards  
Leather: 22½ Sq. Ft.

**Arm Upholstery:**

|             |     |
|-------------|-----|
| COM/COL     | 20  |
| Grade A     | 5   |
| Grade B     | 15  |
| Grade C     | 20  |
| Grade D     | 25  |
| Grade E     | 30  |
| Grade F     | 35  |
| Grade G     | 45  |
| Grade H     | 50  |
| Grade J     | 55  |
| Grade K     | 70  |
| Grade L     | 85  |
| Grade M     | 105 |
| Leather I   | 145 |
| Leather II  | 185 |
| Leather III | 225 |
| Leather IV  | 265 |
| Leather V   | 305 |
| Leather VI  | 345 |

**Upholstery Requires (Per Application):**

Fabric: ½ Yard  
Leather: 9 Sq. Ft.

**Seat Upholstery:**

|             |     |
|-------------|-----|
| COM/COL     | 30  |
| Grade A     | 10  |
| Grade B     | 20  |
| Grade C     | 30  |
| Grade D     | 45  |
| Grade E     | 55  |
| Grade F     | 65  |
| Grade G     | 85  |
| Grade H     | 100 |
| Grade J     | 110 |
| Grade K     | 130 |
| Grade L     | 165 |
| Grade M     | 210 |
| Leather I   | 285 |
| Leather II  | 365 |
| Leather III | 445 |
| Leather IV  | 525 |
| Leather V   | 605 |
| Leather VI  | 685 |

**Upholstery Requires (Per Application):**

Fabric: 1 Yard  
Leather: 18 Sq. Ft.

Base Price: 2860

**Total Required**

**Upholstery:** Fabric: 2¾ Yards  
Leather: 49½ Sq. Ft.

PLEASE SPECIFY THE FOLLOWING TO ORDER:

|              |   |  |   |  |   |
|--------------|---|--|---|--|---|
| MODEL NUMBER | TEXTILES<br>Indicate fabric choice for:<br><br>Back upholstery<br><br><i>See options for fabrics at www.hbftextiles.com</i> | TEXTILES<br>Indicate fabric choice for:<br><br>Arm upholstery<br><br><i>See options for fabrics at www.hbftextiles.com</i> | TEXTILES<br>Indicate fabric choice for:<br><br>Seat upholstery<br><br><i>See options for fabrics at www.hbftextiles.com</i> | FLAMMABILITY<br>Indicate flammability:<br><br><b>U</b> = Cal 117 | CASTER<br><b>DWCM</b> = Double Wheel - Medium Casters<br><b>DWCS</b> = Double Wheel - Soft Casters +\$106 |
|--------------|---|--|---|--|---|

HST222-021.BackFabric.ArmFabric.SeatFabric.Flammability.Caster

Example: HST222-021.950-88.950-88.950-88.U.DWCM



Dimensions

Cadre HST222-031



|    |         |     |         |
|----|---------|-----|---------|
| OH | 35½-39½ | AH  | 26½-30½ |
| OW | 24      | WBA | 19      |
| OD | 26      | DED |         |
| SH | 18½-22½ | DEW |         |
| SD | 19      | R   |         |

|                 |      |
|-----------------|------|
| Shipping Weight | 66   |
| Cube            | 20.4 |

Mid Back | Upholstered Back and Seat | Full Black Wrap Around Arm with Upholstered Arm Cap |

Five-Prong Black Metal Base | Knee Tilt | Double Wheel Casters

ANSI/BIFMA LEVEL® Furniture Sustainability Standard certified  
Indoor Advantage™ certified

**Pricing for Single Fabric Placement:**

**Upholstery:**

|             |      |
|-------------|------|
| COM/COL     | 2655 |
| Grade A     | 2600 |
| Grade B     | 2630 |
| Grade C     | 2655 |
| Grade D     | 2685 |
| Grade E     | 2710 |
| Grade F     | 2745 |
| Grade G     | 2785 |
| Grade H     | 2825 |
| Grade J     | 2850 |
| Grade K     | 2905 |
| Grade L     | 2990 |
| Grade M     | 3100 |
| Leather I   | 3290 |
| Leather II  | 3490 |
| Leather III | 3690 |
| Leather IV  | 3890 |
| Leather V   | 4090 |
| Leather VI  | 4290 |

**Upholstery Requires:**

|          |    |         |
|----------|----|---------|
| Fabric:  | 2½ | Yards   |
| Leather: | 45 | Sq. Ft. |

**Pricing for Multiple Fabric Placement:**

*(To Calculate, Begin with Base Price and add Upcharges)*

**Back Upholstery:**

|             |     |
|-------------|-----|
| COM/COL     | 30  |
| Grade A     | 10  |
| Grade B     | 20  |
| Grade C     | 30  |
| Grade D     | 45  |
| Grade E     | 55  |
| Grade F     | 65  |
| Grade G     | 85  |
| Grade H     | 100 |
| Grade J     | 110 |
| Grade K     | 130 |
| Grade L     | 165 |
| Grade M     | 210 |
| Leather I   | 285 |
| Leather II  | 365 |
| Leather III | 445 |
| Leather IV  | 525 |
| Leather V   | 605 |
| Leather VI  | 685 |

**Upholstery Requires (Per Application):**

|          |    |         |
|----------|----|---------|
| Fabric:  | 1  | Yard    |
| Leather: | 18 | Sq. Ft. |

**Arm Upholstery:**

|             |     |
|-------------|-----|
| COM/COL     | 20  |
| Grade A     | 5   |
| Grade B     | 15  |
| Grade C     | 20  |
| Grade D     | 25  |
| Grade E     | 30  |
| Grade F     | 35  |
| Grade G     | 45  |
| Grade H     | 50  |
| Grade J     | 55  |
| Grade K     | 70  |
| Grade L     | 85  |
| Grade M     | 105 |
| Leather I   | 145 |
| Leather II  | 185 |
| Leather III | 225 |
| Leather IV  | 265 |
| Leather V   | 305 |
| Leather VI  | 345 |

**Upholstery Requires (Per Application):**

|          |   |         |
|----------|---|---------|
| Fabric:  | ½ | Yard    |
| Leather: | 9 | Sq. Ft. |

**Seat Upholstery:**

|             |     |
|-------------|-----|
| COM/COL     | 30  |
| Grade A     | 10  |
| Grade B     | 20  |
| Grade C     | 30  |
| Grade D     | 45  |
| Grade E     | 55  |
| Grade F     | 65  |
| Grade G     | 85  |
| Grade H     | 100 |
| Grade J     | 110 |
| Grade K     | 130 |
| Grade L     | 165 |
| Grade M     | 210 |
| Leather I   | 285 |
| Leather II  | 365 |
| Leather III | 445 |
| Leather IV  | 525 |
| Leather V   | 605 |
| Leather VI  | 685 |

**Upholstery Requires (Per Application):**

|          |    |         |
|----------|----|---------|
| Fabric:  | 1  | Yard    |
| Leather: | 18 | Sq. Ft. |

Base Price: 2575

**Total Required**

**Upholstery:** Fabric: 2½ Yards  
Leather: 45 Sq. Ft.

PLEASE SPECIFY THE FOLLOWING TO ORDER:

|                     |  |   |  |   |  |
|---------------------|--|---|--|---|--|
| <p>MODEL NUMBER</p> | <p>TEXTILES</p> <p>Indicate fabric choice for:</p> <p>Back upholstery</p> <p><i>See options for fabrics at www.hbftextiles.com</i></p> | <p>TEXTILES</p> <p>Indicate fabric choice for:</p> <p>Arm upholstery</p> <p><i>See options for fabrics at www.hbftextiles.com</i></p> | <p>TEXTILES</p> <p>Indicate fabric choice for:</p> <p>Seat upholstery</p> <p><i>See options for fabrics at www.hbftextiles.com</i></p> | <p>FLAMMABILITY</p> <p>Indicate flammability:</p> <p><b>U</b> = Cal 117</p> | <p>CASTER</p> <p><b>DWCM</b> = Double Wheel - Medium Casters</p> <p><b>DWCS</b> = Double Wheel - Soft Casters +\$106</p> |
|---------------------|--|---|--|---|--|

HST222-031.BackFabric.ArmFabric.SeatFabric.Flammability.Caster Example: HST222-031.950-88.950-88.950-88.U.DWCM



Dimensions

Cadre HST222-041



|    |         |     |         |
|----|---------|-----|---------|
| OH | 41½-44½ | AH  | 26½-30½ |
| OW | 24      | WBA | 19      |
| OD | 26      | DED |         |
| SH | 18½-22½ | DEW |         |
| SD | 19      | R   |         |

Shipping Weight 66  
Cube 22.5

High Back | Upholstered Back and Seat | Full Black Wrap Around Arm with Upholstered Arm Cap |

Five-Prong Black Metal Base | Knee Tilt | Double Wheel Casters

ANSI/BIFMA LEVEL® Furniture Sustainability Standard certified  
Indoor Advantage™ certified

**Pricing for Single Fabric Placement:**

**Upholstery:**

|             |      |
|-------------|------|
| COM/COL     | 3005 |
| Grade A     | 2940 |
| Grade B     | 2975 |
| Grade C     | 3005 |
| Grade D     | 3035 |
| Grade E     | 3065 |
| Grade F     | 3100 |
| Grade G     | 3145 |
| Grade H     | 3185 |
| Grade J     | 3215 |
| Grade K     | 3280 |
| Grade L     | 3370 |
| Grade M     | 3490 |
| Leather I   | 3700 |
| Leather II  | 3920 |
| Leather III | 4140 |
| Leather IV  | 4360 |
| Leather V   | 4580 |
| Leather VI  | 4800 |

**Upholstery Requires:**

Fabric: 2¾ Yards  
Leather: 49½ Sq. Ft.

**Pricing for Multiple Fabric Placement:**

*(To Calculate, Begin with Base Price and add Upcharges)*

**Back Upholstery:**

|             |     |
|-------------|-----|
| COM/COL     | 45  |
| Grade A     | 15  |
| Grade B     | 30  |
| Grade C     | 45  |
| Grade D     | 55  |
| Grade E     | 70  |
| Grade F     | 90  |
| Grade G     | 105 |
| Grade H     | 125 |
| Grade J     | 140 |
| Grade K     | 170 |
| Grade L     | 210 |
| Grade M     | 265 |
| Leather I   | 360 |
| Leather II  | 460 |
| Leather III | 560 |
| Leather IV  | 660 |
| Leather V   | 760 |
| Leather VI  | 860 |

**Upholstery Requires (Per Application):**

Fabric: 1¼ Yards  
Leather: 22½ Sq. Ft.

**Arm Upholstery:**

|             |     |
|-------------|-----|
| COM/COL     | 20  |
| Grade A     | 5   |
| Grade B     | 15  |
| Grade C     | 20  |
| Grade D     | 25  |
| Grade E     | 30  |
| Grade F     | 35  |
| Grade G     | 45  |
| Grade H     | 50  |
| Grade J     | 55  |
| Grade K     | 70  |
| Grade L     | 85  |
| Grade M     | 105 |
| Leather I   | 145 |
| Leather II  | 185 |
| Leather III | 225 |
| Leather IV  | 265 |
| Leather V   | 305 |
| Leather VI  | 345 |

**Upholstery Requires (Per Application):**

Fabric: ½ Yard  
Leather: 9 Sq. Ft.

**Seat Upholstery:**

|             |     |
|-------------|-----|
| COM/COL     | 30  |
| Grade A     | 10  |
| Grade B     | 20  |
| Grade C     | 30  |
| Grade D     | 45  |
| Grade E     | 55  |
| Grade F     | 65  |
| Grade G     | 85  |
| Grade H     | 100 |
| Grade J     | 110 |
| Grade K     | 130 |
| Grade L     | 165 |
| Grade M     | 210 |
| Leather I   | 285 |
| Leather II  | 365 |
| Leather III | 445 |
| Leather IV  | 525 |
| Leather V   | 605 |
| Leather VI  | 685 |

**Upholstery Requires (Per Application):**

Fabric: 1 Yard  
Leather: 18 Sq. Ft.

Base Price: 2910

**Total Required**

**Upholstery:** Fabric: 2¾ Yards  
Leather: 49½ Sq. Ft.

PLEASE SPECIFY THE FOLLOWING TO ORDER:

|                     |  |   |  |   |  |
|---------------------|--|---|--|---|--|
| <p>MODEL NUMBER</p> | <p>TEXTILES</p> <p>Indicate fabric choice for:</p> <p>Back upholstery</p> <p><i>See options for fabrics at www.hbftextiles.com</i></p> | <p>TEXTILES</p> <p>Indicate fabric choice for:</p> <p>Arm upholstery</p> <p><i>See options for fabrics at www.hbftextiles.com</i></p> | <p>TEXTILES</p> <p>Indicate fabric choice for:</p> <p>Seat upholstery</p> <p><i>See options for fabrics at www.hbftextiles.com</i></p> | <p>FLAMMABILITY</p> <p>Indicate flammability:</p> <p><b>U</b> = Cal 117</p> | <p>CASTER</p> <p><b>DWCM</b> = Double Wheel - Medium Casters</p> <p><b>DWCS</b> = Double Wheel - Soft Casters +\$106</p> |
|---------------------|--|---|--|---|--|

HST222-041.BackFabric.ArmFabric.SeatFabric.Flammability.Caster Example: HST222-041.950-88.950-88.950-88.U.DWCM





Dimensions

Cadre HST222-051

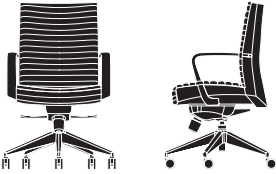

|    |         |     |         |
|----|---------|-----|---------|
| OH | 35½-39½ | AH  | 26½-30½ |
| OW | 24      | WBA | 19      |
| OD | 26      | DED |         |
| SH | 18½-22½ | DEW |         |
| SD | 19      | R   |         |

Shipping Weight 66  
Cube 20.4

Mid Back | Channel Stitched Upholstered Back and Seat | Black Arm with Upholstered Arm Cap | Five-Prong Black Metal Base |

Synchronized Adjustments | Double Wheel Casters

ANSI/BIFMA LEVEL® Furniture Sustainability Standard certified  
Indoor Advantage™ certified

**Pricing for Single Fabric Placement:**

**Upholstery:**

|             |      |
|-------------|------|
| COM/COL     | 3125 |
| Grade A     | 3030 |
| Grade B     | 3075 |
| Grade C     | 3125 |
| Grade D     | 3170 |
| Grade E     | 3220 |
| Grade F     | 3275 |
| Grade G     | 3340 |
| Grade H     | 3405 |
| Grade J     | 3455 |
| Grade K     | 3550 |
| Grade L     | 3690 |
| Grade M     | 3880 |
| Leather I   | 4200 |
| Leather II  | 4540 |
| Leather III | 4880 |
| Leather IV  | 5220 |
| Leather V   | 5560 |
| Leather VI  | 5900 |

**Upholstery Requires:**

Fabric: 4¼ Yards  
Leather: 76½ Sq. Ft.

**Pricing for Multiple Fabric Placement:**

*(To Calculate, Begin with Base Price and add Upcharges)*

**Back Upholstery:**

|             |      |
|-------------|------|
| COM/COL     | 75   |
| Grade A     | 25   |
| Grade B     | 50   |
| Grade C     | 75   |
| Grade D     | 100  |
| Grade E     | 125  |
| Grade F     | 155  |
| Grade G     | 190  |
| Grade H     | 225  |
| Grade J     | 250  |
| Grade K     | 300  |
| Grade L     | 375  |
| Grade M     | 475  |
| Leather I   | 645  |
| Leather II  | 825  |
| Leather III | 1005 |
| Leather IV  | 1185 |
| Leather V   | 1365 |
| Leather VI  | 1545 |

**Upholstery Requires (Per Application):**

Fabric: 2¼ Yards  
Leather: 40½ Sq. Ft.

**Arm Upholstery:**

|             |     |
|-------------|-----|
| COM/COL     | 20  |
| Grade A     | 5   |
| Grade B     | 15  |
| Grade C     | 20  |
| Grade D     | 25  |
| Grade E     | 30  |
| Grade F     | 35  |
| Grade G     | 45  |
| Grade H     | 50  |
| Grade J     | 55  |
| Grade K     | 70  |
| Grade L     | 85  |
| Grade M     | 105 |
| Leather I   | 145 |
| Leather II  | 185 |
| Leather III | 225 |
| Leather IV  | 265 |
| Leather V   | 305 |
| Leather VI  | 345 |

**Upholstery Requires (Per Application):**

Fabric: ½ Yard  
Leather: 9 Sq. Ft.

**Seat Upholstery:**

|             |      |
|-------------|------|
| COM/COL     | 50   |
| Grade A     | 15   |
| Grade B     | 35   |
| Grade C     | 50   |
| Grade D     | 65   |
| Grade E     | 85   |
| Grade F     | 105  |
| Grade G     | 125  |
| Grade H     | 150  |
| Grade J     | 165  |
| Grade K     | 200  |
| Grade L     | 250  |
| Grade M     | 315  |
| Leather I   | 430  |
| Leather II  | 550  |
| Leather III | 670  |
| Leather IV  | 790  |
| Leather V   | 910  |
| Leather VI  | 1030 |

**Upholstery Requires (Per Application):**

Fabric: 1½ Yards  
Leather: 27 Sq. Ft.

Base Price: 2980

**Total Required**

**Upholstery:** Fabric: 4¼ Yards  
Leather: 76½ Sq. Ft.

PLEASE SPECIFY THE FOLLOWING TO ORDER:

|                     |  |   |  |   |  |
|---------------------|--|---|--|---|--|
| <p>MODEL NUMBER</p> | <p>TEXTILES</p> <p>Indicate fabric choice for:</p> <p>Back upholstery</p> <p><i>See options for fabrics at www.hbftextiles.com</i></p> | <p>TEXTILES</p> <p>Indicate fabric choice for:</p> <p>Arm upholstery</p> <p><i>See options for fabrics at www.hbftextiles.com</i></p> | <p>TEXTILES</p> <p>Indicate fabric choice for:</p> <p>Seat upholstery</p> <p><i>See options for fabrics at www.hbftextiles.com</i></p> | <p>FLAMMABILITY</p> <p>Indicate flammability:</p> <p><b>U</b> = Cal 117</p> | <p>CASTER</p> <p><b>DWCM</b> = Double Wheel - Medium Casters</p> <p><b>DWCS</b> = Double Wheel - Soft Casters +\$106</p> |
|---------------------|--|---|--|---|--|

HST222-051.BackFabric.ArmFabric.SeatFabric.Flammability.Caster

Example: HST222-051.950-88.950-88.950-88.U.DWCM



**Dimensions**

**Cadre HST222-061**



|    |         |     |         |
|----|---------|-----|---------|
| OH | 41½-44½ | AH  | 26½-30½ |
| OW | 24      | WBA | 19      |
| OD | 26      | DED |         |
| SH | 18½-22½ | DEW |         |
| SD | 19      | R   |         |

Shipping Weight 66  
Cube 22.5

High Back | Channel Stitched Upholstered Back and Seat | Black Arm with Upholstered Arm Cap | Five-Prong Black Metal Base |

Synchronized Adjustments | Double Wheel Casters

ANSI/BIFMA LEVEL® Furniture Sustainability Standard certified  
Indoor Advantage™ certified

**Pricing for Single Fabric Placement:**

**Upholstery:**

|             |      |
|-------------|------|
| COM/COL     | 3415 |
| Grade A     | 3330 |
| Grade B     | 3375 |
| Grade C     | 3415 |
| Grade D     | 3455 |
| Grade E     | 3500 |
| Grade F     | 3550 |
| Grade G     | 3605 |
| Grade H     | 3665 |
| Grade J     | 3705 |
| Grade K     | 3790 |
| Grade L     | 3915 |
| Grade M     | 4080 |
| Leather I   | 4365 |
| Leather II  | 4665 |
| Leather III | 4965 |
| Leather IV  | 5265 |
| Leather V   | 5565 |
| Leather VI  | 5865 |

**Upholstery Requires:**

Fabric: 3¾ Yards  
Leather: 67½ Sq. Ft.

**Pricing for Multiple Fabric Placement:**

*(To Calculate, Begin with Base Price and add Upcharges)*

**Back Upholstery:**

|             |      |
|-------------|------|
| COM/COL     | 55   |
| Grade A     | 20   |
| Grade B     | 35   |
| Grade C     | 55   |
| Grade D     | 75   |
| Grade E     | 95   |
| Grade F     | 120  |
| Grade G     | 145  |
| Grade H     | 175  |
| Grade J     | 195  |
| Grade K     | 230  |
| Grade L     | 290  |
| Grade M     | 370  |
| Leather I   | 500  |
| Leather II  | 640  |
| Leather III | 780  |
| Leather IV  | 920  |
| Leather V   | 1060 |
| Leather VI  | 1200 |

**Upholstery Requires (Per Application):**

Fabric: 1¾ Yards  
Leather: 31½ Sq. Ft.

**Arm Upholstery:**

|             |     |
|-------------|-----|
| COM/COL     | 20  |
| Grade A     | 5   |
| Grade B     | 15  |
| Grade C     | 20  |
| Grade D     | 25  |
| Grade E     | 30  |
| Grade F     | 35  |
| Grade G     | 45  |
| Grade H     | 50  |
| Grade J     | 55  |
| Grade K     | 70  |
| Grade L     | 85  |
| Grade M     | 105 |
| Leather I   | 145 |
| Leather II  | 185 |
| Leather III | 225 |
| Leather IV  | 265 |
| Leather V   | 305 |
| Leather VI  | 345 |

**Upholstery Requires (Per Application):**

Fabric: ½ Yard  
Leather: 9 Sq. Ft.

**Seat Upholstery:**

|             |      |
|-------------|------|
| COM/COL     | 50   |
| Grade A     | 15   |
| Grade B     | 35   |
| Grade C     | 50   |
| Grade D     | 65   |
| Grade E     | 85   |
| Grade F     | 105  |
| Grade G     | 125  |
| Grade H     | 150  |
| Grade J     | 165  |
| Grade K     | 200  |
| Grade L     | 250  |
| Grade M     | 315  |
| Leather I   | 430  |
| Leather II  | 550  |
| Leather III | 670  |
| Leather IV  | 790  |
| Leather V   | 910  |
| Leather VI  | 1030 |

**Upholstery Requires (Per Application):**

Fabric: 1½ Yards  
Leather: 27 Sq. Ft.

Base Price: 3290

**Total Required**

**Upholstery:** Fabric: 3¾ Yards  
Leather: 67½ Sq. Ft.

PLEASE SPECIFY THE FOLLOWING TO ORDER:

|                            |  |   |  |  |   |
|----------------------------|--|---|--|--|---|
| <p><b>MODEL NUMBER</b></p> | <p><b>TEXTILES</b></p> <p>Indicate fabric choice for:</p> <p>Back upholstery</p> <p><i>See options for fabrics at <a href="http://www.hbftextiles.com">www.hbftextiles.com</a></i></p> | <p><b>TEXTILES</b></p> <p>Indicate fabric choice for:</p> <p>Arm upholstery</p> <p><i>See options for fabrics at <a href="http://www.hbftextiles.com">www.hbftextiles.com</a></i></p> | <p><b>TEXTILES</b></p> <p>Indicate fabric choice for:</p> <p>Seat upholstery</p> <p><i>See options for fabrics at <a href="http://www.hbftextiles.com">www.hbftextiles.com</a></i></p> | <p><b>FLAMMABILITY</b></p> <p>Indicate flammability:</p> <p><b>U</b> = Cal 117</p> | <p><b>CASTER</b></p> <p><b>DWCM</b> = Double Wheel - Medium Casters</p> <p><b>DWCS</b> = Double Wheel - Soft Casters +\$106</p> |
|----------------------------|--|---|--|--|---|

HST222-061.BackFabric.ArmFabric.SeatFabric.Flammability.Caster

Example: HST222-061.950-88.950-88.950-88.U.DWCM



**Dimensions**

**Cadre HST222-071**



|    |         |     |         |
|----|---------|-----|---------|
| OH | 35½-39½ | AH  | 26½-30½ |
| OW | 24      | WBA | 19      |
| OD | 26      | DED |         |
| SH | 18½-22½ | DEW |         |
| SD | 19      | R   |         |

|                 |      |
|-----------------|------|
| Shipping Weight | 66   |
| Cube            | 20.4 |

Mid Back | Channel Stitched Upholstered Back and Seat | Full Black Wrap Around Arm with Upholstered Arm Cap | Five-Prong Black Metal Base | Knee Tilt | Double Wheel Casters

ANSI/BIFMA LEVEL® Furniture Sustainability Standard certified  
Indoor Advantage™ certified

**Pricing for Single Fabric Placement:**

**Upholstery:**

|             |      |
|-------------|------|
| COM/COL     | 3175 |
| Grade A     | 3080 |
| Grade B     | 3125 |
| Grade C     | 3175 |
| Grade D     | 3220 |
| Grade E     | 3270 |
| Grade F     | 3325 |
| Grade G     | 3390 |
| Grade H     | 3455 |
| Grade J     | 3505 |
| Grade K     | 3600 |
| Grade L     | 3740 |
| Grade M     | 3930 |
| Leather I   | 4250 |
| Leather II  | 4590 |
| Leather III | 4930 |
| Leather IV  | 5270 |
| Leather V   | 5610 |
| Leather VI  | 5950 |

**Upholstery Requires:**

Fabric: 4¼ Yards  
Leather: 76½ Sq. Ft.

**Pricing for Multiple Fabric Placement:**

*(To Calculate, Begin with Base Price and add Upcharges)*

**Back Upholstery:**

|             |      |
|-------------|------|
| COM/COL     | 75   |
| Grade A     | 25   |
| Grade B     | 50   |
| Grade C     | 75   |
| Grade D     | 100  |
| Grade E     | 125  |
| Grade F     | 155  |
| Grade G     | 190  |
| Grade H     | 225  |
| Grade J     | 250  |
| Grade K     | 300  |
| Grade L     | 375  |
| Grade M     | 475  |
| Leather I   | 645  |
| Leather II  | 825  |
| Leather III | 1005 |
| Leather IV  | 1185 |
| Leather V   | 1365 |
| Leather VI  | 1545 |

**Upholstery Requires (Per Application):**

Fabric: 2¼ Yards  
Leather: 40½ Sq. Ft.

**Arm Upholstery:**

|             |     |
|-------------|-----|
| COM/COL     | 20  |
| Grade A     | 5   |
| Grade B     | 15  |
| Grade C     | 20  |
| Grade D     | 25  |
| Grade E     | 30  |
| Grade F     | 35  |
| Grade G     | 45  |
| Grade H     | 50  |
| Grade J     | 55  |
| Grade K     | 70  |
| Grade L     | 85  |
| Grade M     | 105 |
| Leather I   | 145 |
| Leather II  | 185 |
| Leather III | 225 |
| Leather IV  | 265 |
| Leather V   | 305 |
| Leather VI  | 345 |

**Upholstery Requires (Per Application):**

Fabric: ½ Yard  
Leather: 9 Sq. Ft.

**Seat Upholstery:**

|             |      |
|-------------|------|
| COM/COL     | 50   |
| Grade A     | 15   |
| Grade B     | 35   |
| Grade C     | 50   |
| Grade D     | 65   |
| Grade E     | 85   |
| Grade F     | 105  |
| Grade G     | 125  |
| Grade H     | 150  |
| Grade J     | 165  |
| Grade K     | 200  |
| Grade L     | 250  |
| Grade M     | 315  |
| Leather I   | 430  |
| Leather II  | 550  |
| Leather III | 670  |
| Leather IV  | 790  |
| Leather V   | 910  |
| Leather VI  | 1030 |

**Upholstery Requires (Per Application):**

Fabric: 1½ Yards  
Leather: 27 Sq. Ft.

Base Price: 3030

**Total Required**

**Upholstery:** Fabric: 4¼ Yards  
Leather: 76½ Sq. Ft.

PLEASE SPECIFY THE FOLLOWING TO ORDER:

|                            |  |   |  |  |   |
|----------------------------|--|---|--|--|---|
| <p><b>MODEL NUMBER</b></p> | <p><b>TEXTILES</b></p> <p>Indicate fabric choice for:</p> <p>Back upholstery</p> <p><i>See options for fabrics at <a href="http://www.hbftextiles.com">www.hbftextiles.com</a></i></p> | <p><b>TEXTILES</b></p> <p>Indicate fabric choice for:</p> <p>Arm upholstery</p> <p><i>See options for fabrics at <a href="http://www.hbftextiles.com">www.hbftextiles.com</a></i></p> | <p><b>TEXTILES</b></p> <p>Indicate fabric choice for:</p> <p>Seat upholstery</p> <p><i>See options for fabrics at <a href="http://www.hbftextiles.com">www.hbftextiles.com</a></i></p> | <p><b>FLAMMABILITY</b></p> <p>Indicate flammability:</p> <p><b>U</b> = Cal 117</p> | <p><b>CASTER</b></p> <p><b>DWCM</b> = Double Wheel - Medium Casters</p> <p><b>DWCS</b> = Double Wheel - Soft Casters +\$106</p> |
|----------------------------|--|---|--|--|---|

HST222-071.BackFabric.ArmFabric.SeatFabric.Flammability.Caster Example: HST222-071.950-88.950-88.950-88.U.DWCM



Dimensions

Cadre HST222-081



|    |         |     |         |
|----|---------|-----|---------|
| OH | 41½-44½ | AH  | 26½-30½ |
| OW | 24      | WBA | 19      |
| OD | 26      | DED |         |
| SH | 18½-22½ | DEW |         |
| SD | 19      | R   |         |

|                 |      |
|-----------------|------|
| Shipping Weight | 66   |
| Cube            | 22.5 |

High Back | Channel Stitched Upholstered Back and Seat | Full Black Wrap Around Arm with Upholstered Arm Cap | Five-Prong Black Metal Base | Knee Tilt | Double Wheel Casters

ANSI/BIFMA LEVEL® Furniture Sustainability Standard certified  
Indoor Advantage™ certified

**Pricing for Single Fabric Placement:**

**Upholstery:**

|             |      |
|-------------|------|
| COM/COL     | 3470 |
| Grade A     | 3385 |
| Grade B     | 3430 |
| Grade C     | 3470 |
| Grade D     | 3510 |
| Grade E     | 3555 |
| Grade F     | 3605 |
| Grade G     | 3660 |
| Grade H     | 3720 |
| Grade J     | 3760 |
| Grade K     | 3845 |
| Grade L     | 3970 |
| Grade M     | 4135 |
| Leather I   | 4420 |
| Leather II  | 4720 |
| Leather III | 5020 |
| Leather IV  | 5320 |
| Leather V   | 5620 |
| Leather VI  | 5920 |

**Upholstery Requires:**

Fabric: 3¾ Yards  
Leather: 67½ Sq. Ft.

**Pricing for Multiple Fabric Placement:**

*(To Calculate, Begin with Base Price and add Upcharges)*

**Back Upholstery:**

|             |      |
|-------------|------|
| COM/COL     | 55   |
| Grade A     | 20   |
| Grade B     | 35   |
| Grade C     | 55   |
| Grade D     | 75   |
| Grade E     | 95   |
| Grade F     | 120  |
| Grade G     | 145  |
| Grade H     | 175  |
| Grade J     | 195  |
| Grade K     | 230  |
| Grade L     | 290  |
| Grade M     | 370  |
| Leather I   | 500  |
| Leather II  | 640  |
| Leather III | 780  |
| Leather IV  | 920  |
| Leather V   | 1060 |
| Leather VI  | 1200 |

**Upholstery Requires (Per Application):**

Fabric: 1¾ Yards  
Leather: 31½ Sq. Ft.

**Arm Upholstery:**

|             |     |
|-------------|-----|
| COM/COL     | 20  |
| Grade A     | 5   |
| Grade B     | 15  |
| Grade C     | 20  |
| Grade D     | 25  |
| Grade E     | 30  |
| Grade F     | 35  |
| Grade G     | 45  |
| Grade H     | 50  |
| Grade J     | 55  |
| Grade K     | 70  |
| Grade L     | 85  |
| Grade M     | 105 |
| Leather I   | 145 |
| Leather II  | 185 |
| Leather III | 225 |
| Leather IV  | 265 |
| Leather V   | 305 |
| Leather VI  | 345 |

**Upholstery Requires (Per Application):**

Fabric: ½ Yard  
Leather: 9 Sq. Ft.

**Seat Upholstery:**

|             |      |
|-------------|------|
| COM/COL     | 50   |
| Grade A     | 15   |
| Grade B     | 35   |
| Grade C     | 50   |
| Grade D     | 65   |
| Grade E     | 85   |
| Grade F     | 105  |
| Grade G     | 125  |
| Grade H     | 150  |
| Grade J     | 165  |
| Grade K     | 200  |
| Grade L     | 250  |
| Grade M     | 315  |
| Leather I   | 430  |
| Leather II  | 550  |
| Leather III | 670  |
| Leather IV  | 790  |
| Leather V   | 910  |
| Leather VI  | 1030 |

**Upholstery Requires (Per Application):**

Fabric: 1½ Yards  
Leather: 27 Sq. Ft.

Base Price: 3345

**Total Required**

**Upholstery:** Fabric: 3¾ Yards  
Leather: 67½ Sq. Ft.

PLEASE SPECIFY THE FOLLOWING TO ORDER:

|                     |   |  |   |   |  |
|---------------------|---|--|---|---|--|
| <p>MODEL NUMBER</p> | <p>TEXTILES</p> <p>Indicate fabric choice for:</p> <p>Back upholstery</p> <p><i>See options for fabrics at <a href="http://www.hbftextiles.com">www.hbftextiles.com</a></i></p> | <p>TEXTILES</p> <p>Indicate fabric choice for:</p> <p>Arm upholstery</p> <p><i>See options for fabrics at <a href="http://www.hbftextiles.com">www.hbftextiles.com</a></i></p> | <p>TEXTILES</p> <p>Indicate fabric choice for:</p> <p>Seat upholstery</p> <p><i>See options for fabrics at <a href="http://www.hbftextiles.com">www.hbftextiles.com</a></i></p> | <p>FLAMMABILITY</p> <p>Indicate flammability:</p> <p><b>U</b> = Cal 117</p> | <p>CASTER</p> <p><b>DWCM</b> = Double Wheel - Medium Casters</p> <p><b>DWCS</b> = Double Wheel - Soft Casters +\$106</p> |
|---------------------|---|--|---|---|--|

HST222-081.BackFabric.ArmFabric.SeatFabric.Flammability.Caster Example: HST222-081.950-88.950-88.950-88.U.DWCM



Dimensions

Cadre HST222-511



|    |         |     |         |
|----|---------|-----|---------|
| OH | 35½-39½ | AH  | 26½-30½ |
| OW | 24      | WBA | 19      |
| OD | 26      | DED |         |
| SH | 18½-22½ | DEW |         |
| SD | 19      | R   |         |

Shipping Weight 66  
Cube 20.4

Mid Back | Upholstered Back and Seat | Polished Aluminum Arm with Upholstered Arm Cap |

ANSI/BIFMA LEVEL® Furniture Sustainability Standard certified  
Indoor Advantage™ certified

Synchronized Adjustments | Five-Prong Polished Aluminum Base | Double Wheel Casters

**Pricing for Single Fabric Placement:**

**Upholstery:**

|             |      |
|-------------|------|
| COM/COL     | 2615 |
| Grade A     | 2560 |
| Grade B     | 2590 |
| Grade C     | 2615 |
| Grade D     | 2645 |
| Grade E     | 2670 |
| Grade F     | 2705 |
| Grade G     | 2745 |
| Grade H     | 2785 |
| Grade J     | 2810 |
| Grade K     | 2865 |
| Grade L     | 2950 |
| Grade M     | 3060 |
| Leather I   | 3250 |
| Leather II  | 3450 |
| Leather III | 3650 |
| Leather IV  | 3850 |
| Leather V   | 4050 |
| Leather VI  | 4250 |

**Upholstery Requires:**

Fabric: 2½ Yards  
Leather: 45 Sq. Ft.

**Pricing for Multiple Fabric Placement:**

*(To Calculate, Begin with Base Price and add Upcharges)*

**Back Upholstery:**

|             |     |
|-------------|-----|
| COM/COL     | 30  |
| Grade A     | 10  |
| Grade B     | 20  |
| Grade C     | 30  |
| Grade D     | 45  |
| Grade E     | 55  |
| Grade F     | 65  |
| Grade G     | 85  |
| Grade H     | 100 |
| Grade J     | 110 |
| Grade K     | 130 |
| Grade L     | 165 |
| Grade M     | 210 |
| Leather I   | 285 |
| Leather II  | 365 |
| Leather III | 445 |
| Leather IV  | 525 |
| Leather V   | 605 |
| Leather VI  | 685 |

**Upholstery Requires (Per Application):**

Fabric: 1 Yard  
Leather: 18 Sq. Ft.

**Arm Upholstery:**

|             |     |
|-------------|-----|
| COM/COL     | 20  |
| Grade A     | 5   |
| Grade B     | 15  |
| Grade C     | 20  |
| Grade D     | 25  |
| Grade E     | 30  |
| Grade F     | 35  |
| Grade G     | 45  |
| Grade H     | 50  |
| Grade J     | 55  |
| Grade K     | 70  |
| Grade L     | 85  |
| Grade M     | 105 |
| Leather I   | 145 |
| Leather II  | 185 |
| Leather III | 225 |
| Leather IV  | 265 |
| Leather V   | 305 |
| Leather VI  | 345 |

**Upholstery Requires (Per Application):**

Fabric: ½ Yard  
Leather: 9 Sq. Ft.

**Seat Upholstery:**

|             |     |
|-------------|-----|
| COM/COL     | 30  |
| Grade A     | 10  |
| Grade B     | 20  |
| Grade C     | 30  |
| Grade D     | 45  |
| Grade E     | 55  |
| Grade F     | 65  |
| Grade G     | 85  |
| Grade H     | 100 |
| Grade J     | 110 |
| Grade K     | 130 |
| Grade L     | 165 |
| Grade M     | 210 |
| Leather I   | 285 |
| Leather II  | 365 |
| Leather III | 445 |
| Leather IV  | 525 |
| Leather V   | 605 |
| Leather VI  | 685 |

**Upholstery Requires (Per Application):**

Fabric: 1 Yard  
Leather: 18 Sq. Ft.

Base Price: 2535

**Total Required**

**Upholstery:** Fabric: 2½ Yards  
Leather: 45 Sq. Ft.

PLEASE SPECIFY THE FOLLOWING TO ORDER:

|              |   |  |   |  |   |
|--------------|---|--|---|--|---|
| MODEL NUMBER | TEXTILES<br>Indicate fabric choice for:<br><br>Back upholstery<br><br><i>See options for fabrics at www.hbftextiles.com</i> | TEXTILES<br>Indicate fabric choice for:<br><br>Arm upholstery<br><br><i>See options for fabrics at www.hbftextiles.com</i> | TEXTILES<br>Indicate fabric choice for:<br><br>Seat upholstery<br><br><i>See options for fabrics at www.hbftextiles.com</i> | FLAMMABILITY<br>Indicate flammability:<br><br><b>U</b> = Cal 117 | CASTER<br><b>DWCM</b> = Double Wheel - Medium Casters<br><b>DWCS</b> = Double Wheel - Soft Casters +\$106 |
|--------------|---|--|---|--|---|

HST222-511.BackFabric.ArmFabric.SeatFabric.Flammability.Caster Example: HST222-511.950-88.950-88.950-88.U.DWCM



Dimensions

Cadre HST222-521



|                 |         |      |         |
|-----------------|---------|------|---------|
| OH              | 41½-44½ | AH   | 26½-30½ |
| OW              | 24      | WBA  | 19      |
| OD              | 26      | DED  |         |
| SH              | 18½-22½ | DEW  |         |
| SD              | 19      | R    |         |
| Shipping Weight |         | 66   |         |
| Cube            |         | 22.5 |         |

High Back | Upholstered Back and Seat | Polished Aluminum Arm with Upholstered Arm Cap |

Synchronized Adjustments | Five-Prong Polished Aluminum Base | Double Wheel Casters

ANSI/BIFMA LEVEL® Furniture Sustainability Standard certified  
Indoor Advantage™ certified

**Pricing for Single Fabric Placement:**

**Upholstery:**

|             |      |
|-------------|------|
| COM/COL     | 2955 |
| Grade A     | 2890 |
| Grade B     | 2925 |
| Grade C     | 2955 |
| Grade D     | 2985 |
| Grade E     | 3015 |
| Grade F     | 3050 |
| Grade G     | 3095 |
| Grade H     | 3135 |
| Grade J     | 3165 |
| Grade K     | 3230 |
| Grade L     | 3320 |
| Grade M     | 3440 |
| Leather I   | 3650 |
| Leather II  | 3870 |
| Leather III | 4090 |
| Leather IV  | 4310 |
| Leather V   | 4530 |
| Leather VI  | 4750 |

**Upholstery Requires:**

Fabric: 2¾ Yards  
Leather: 49½ Sq. Ft.

**Pricing for Multiple Fabric Placement:**

*(To Calculate, Begin with Base Price and add Upcharges)*

**Back Upholstery:**

|             |     |
|-------------|-----|
| COM/COL     | 45  |
| Grade A     | 15  |
| Grade B     | 30  |
| Grade C     | 45  |
| Grade D     | 55  |
| Grade E     | 70  |
| Grade F     | 90  |
| Grade G     | 105 |
| Grade H     | 125 |
| Grade J     | 140 |
| Grade K     | 170 |
| Grade L     | 210 |
| Grade M     | 265 |
| Leather I   | 360 |
| Leather II  | 460 |
| Leather III | 560 |
| Leather IV  | 660 |
| Leather V   | 760 |
| Leather VI  | 860 |

**Upholstery Requires (Per Application):**

Fabric: 1¼ Yards  
Leather: 22½ Sq. Ft.

**Arm Upholstery:**

|             |     |
|-------------|-----|
| COM/COL     | 20  |
| Grade A     | 5   |
| Grade B     | 15  |
| Grade C     | 20  |
| Grade D     | 25  |
| Grade E     | 30  |
| Grade F     | 35  |
| Grade G     | 45  |
| Grade H     | 50  |
| Grade J     | 55  |
| Grade K     | 70  |
| Grade L     | 85  |
| Grade M     | 105 |
| Leather I   | 145 |
| Leather II  | 185 |
| Leather III | 225 |
| Leather IV  | 265 |
| Leather V   | 305 |
| Leather VI  | 345 |

**Upholstery Requires (Per Application):**

Fabric: ½ Yard  
Leather: 9 Sq. Ft.

**Seat Upholstery:**

|             |     |
|-------------|-----|
| COM/COL     | 30  |
| Grade A     | 10  |
| Grade B     | 20  |
| Grade C     | 30  |
| Grade D     | 45  |
| Grade E     | 55  |
| Grade F     | 65  |
| Grade G     | 85  |
| Grade H     | 100 |
| Grade J     | 110 |
| Grade K     | 130 |
| Grade L     | 165 |
| Grade M     | 210 |
| Leather I   | 285 |
| Leather II  | 365 |
| Leather III | 445 |
| Leather IV  | 525 |
| Leather V   | 605 |
| Leather VI  | 685 |

**Upholstery Requires (Per Application):**

Fabric: 1 Yard  
Leather: 18 Sq. Ft.

Base Price: 2860

**Total Required**

**Upholstery:** Fabric: 2¾ Yards  
Leather: 49½ Sq. Ft.

PLEASE SPECIFY THE FOLLOWING TO ORDER:

|                     |   |  |   |   |  |
|---------------------|---|--|---|---|--|
| <p>MODEL NUMBER</p> | <p>TEXTILES</p> <p>Indicate fabric choice for:</p> <p>Back upholstery</p> <p><i>See options for fabrics at <a href="http://www.hbftextiles.com">www.hbftextiles.com</a></i></p> | <p>TEXTILES</p> <p>Indicate fabric choice for:</p> <p>Arm upholstery</p> <p><i>See options for fabrics at <a href="http://www.hbftextiles.com">www.hbftextiles.com</a></i></p> | <p>TEXTILES</p> <p>Indicate fabric choice for:</p> <p>Seat upholstery</p> <p><i>See options for fabrics at <a href="http://www.hbftextiles.com">www.hbftextiles.com</a></i></p> | <p>FLAMMABILITY</p> <p>Indicate flammability:</p> <p><b>U</b> = Cal 117</p> | <p>CASTER</p> <p><b>DWCM</b> = Double Wheel - Medium Casters</p> <p><b>DWCS</b> = Double Wheel - Soft Casters +\$106</p> |
|---------------------|---|--|---|---|--|

HST222-521.BackFabric.ArmFabric.SeatFabric.Flammability.Caster Example: HST222-521.950-88.950-88.950-88.U.DWCM



Dimensions

Cadre HST222-531



|    |         |     |         |
|----|---------|-----|---------|
| OH | 35½-39½ | AH  | 26½-30½ |
| OW | 24      | WBA | 19      |
| OD | 26      | DED |         |
| SH | 18½-22½ | DEW |         |
| SD | 19      | R   |         |

Shipping Weight 66  
Cube 20.4

Mid Back | Upholstered Back and Seat | Full Polished Aluminum Wrap Around Arm with Upholstered Arm Cap |

ANSI/BIFMA LEVEL® Furniture Sustainability Standard certified  
Indoor Advantage™ certified

Knee Tilt | Five-Prong Polished Aluminum Base | Double Wheel Casters

**Pricing for Single Fabric Placement:**

**Upholstery:**

|             |      |
|-------------|------|
| COM/COL     | 2655 |
| Grade A     | 2600 |
| Grade B     | 2630 |
| Grade C     | 2655 |
| Grade D     | 2685 |
| Grade E     | 2710 |
| Grade F     | 2745 |
| Grade G     | 2785 |
| Grade H     | 2825 |
| Grade J     | 2850 |
| Grade K     | 2905 |
| Grade L     | 2990 |
| Grade M     | 3100 |
| Leather I   | 3290 |
| Leather II  | 3490 |
| Leather III | 3690 |
| Leather IV  | 3890 |
| Leather V   | 4090 |
| Leather VI  | 4290 |

**Upholstery Requires:**

Fabric: 2½ Yards  
Leather: 45 Sq. Ft.

**Pricing for Multiple Fabric Placement:**

*(To Calculate, Begin with Base Price and add Upcharges)*

**Back Upholstery:**

|             |     |
|-------------|-----|
| COM/COL     | 30  |
| Grade A     | 10  |
| Grade B     | 20  |
| Grade C     | 30  |
| Grade D     | 45  |
| Grade E     | 55  |
| Grade F     | 65  |
| Grade G     | 85  |
| Grade H     | 100 |
| Grade J     | 110 |
| Grade K     | 130 |
| Grade L     | 165 |
| Grade M     | 210 |
| Leather I   | 285 |
| Leather II  | 365 |
| Leather III | 445 |
| Leather IV  | 525 |
| Leather V   | 605 |
| Leather VI  | 685 |

**Upholstery Requires (Per Application):**

Fabric: 1 Yard  
Leather: 18 Sq. Ft.

**Arm Upholstery:**

|             |     |
|-------------|-----|
| COM/COL     | 20  |
| Grade A     | 5   |
| Grade B     | 15  |
| Grade C     | 20  |
| Grade D     | 25  |
| Grade E     | 30  |
| Grade F     | 35  |
| Grade G     | 45  |
| Grade H     | 50  |
| Grade J     | 55  |
| Grade K     | 70  |
| Grade L     | 85  |
| Grade M     | 105 |
| Leather I   | 145 |
| Leather II  | 185 |
| Leather III | 225 |
| Leather IV  | 265 |
| Leather V   | 305 |
| Leather VI  | 345 |

**Upholstery Requires (Per Application):**

Fabric: ½ Yard  
Leather: 9 Sq. Ft.

**Seat Upholstery:**

|             |     |
|-------------|-----|
| COM/COL     | 30  |
| Grade A     | 10  |
| Grade B     | 20  |
| Grade C     | 30  |
| Grade D     | 45  |
| Grade E     | 55  |
| Grade F     | 65  |
| Grade G     | 85  |
| Grade H     | 100 |
| Grade J     | 110 |
| Grade K     | 130 |
| Grade L     | 165 |
| Grade M     | 210 |
| Leather I   | 285 |
| Leather II  | 365 |
| Leather III | 445 |
| Leather IV  | 525 |
| Leather V   | 605 |
| Leather VI  | 685 |

**Upholstery Requires (Per Application):**

Fabric: 1 Yard  
Leather: 18 Sq. Ft.

Base Price: 2575

**Total Required**

**Upholstery:** Fabric: 2½ Yards  
Leather: 45 Sq. Ft.

PLEASE SPECIFY THE FOLLOWING TO ORDER:

|                     |  |   |  |   |  |
|---------------------|--|---|--|---|--|
| <p>MODEL NUMBER</p> | <p>TEXTILES</p> <p>Indicate fabric choice for:</p> <p>Back upholstery</p> <p><i>See options for fabrics at www.hbftextiles.com</i></p> | <p>TEXTILES</p> <p>Indicate fabric choice for:</p> <p>Arm upholstery</p> <p><i>See options for fabrics at www.hbftextiles.com</i></p> | <p>TEXTILES</p> <p>Indicate fabric choice for:</p> <p>Seat upholstery</p> <p><i>See options for fabrics at www.hbftextiles.com</i></p> | <p>FLAMMABILITY</p> <p>Indicate flammability:</p> <p><input type="checkbox"/> U = Cal 117</p> | <p>CASTER</p> <p><input type="checkbox"/> DWCM = Double Wheel - Medium Casters</p> <p><input type="checkbox"/> DWCS = Double Wheel - Soft Casters +\$106</p> |
|---------------------|--|---|--|---|--|

HST222-531.BackFabric.ArmFabric.SeatFabric.Flammability.Caster Example: HST222-531.950-88.950-88.950-88.U.DWCM



Dimensions

Cadre HST222-541



|    |         |     |         |
|----|---------|-----|---------|
| OH | 41½-44½ | AH  | 26½-30½ |
| OW | 24      | WBA | 19      |
| OD | 26      | DED |         |
| SH | 18½-22½ | DEW |         |
| SD | 19      | R   |         |

|                 |      |
|-----------------|------|
| Shipping Weight | 66   |
| Cube            | 22.5 |

High Back | Upholstered Back and Seat | Full Polished Aluminum Wrap Around Arm with Upholstered Arm Cap |

ANSI/BIFMA LEVEL® Furniture Sustainability Standard certified  
Indoor Advantage™ certified

Knee Tilt | Five-Prong Polished Aluminum Base | Double Wheel Casters

**Pricing for Single Fabric Placement:**

**Upholstery:**

|             |      |
|-------------|------|
| COM/COL     | 3005 |
| Grade A     | 2940 |
| Grade B     | 2975 |
| Grade C     | 3005 |
| Grade D     | 3035 |
| Grade E     | 3065 |
| Grade F     | 3100 |
| Grade G     | 3145 |
| Grade H     | 3185 |
| Grade J     | 3215 |
| Grade K     | 3280 |
| Grade L     | 3370 |
| Grade M     | 3490 |
| Leather I   | 3700 |
| Leather II  | 3920 |
| Leather III | 4140 |
| Leather IV  | 4360 |
| Leather V   | 4580 |
| Leather VI  | 4800 |

**Upholstery Requires:**

Fabric: 2¾ Yards  
Leather: 49½ Sq. Ft.

**Pricing for Multiple Fabric Placement:**  
*(To Calculate, Begin with Base Price and add Upcharges)*

**Back Upholstery:**

|             |     |
|-------------|-----|
| COM/COL     | 45  |
| Grade A     | 15  |
| Grade B     | 30  |
| Grade C     | 45  |
| Grade D     | 55  |
| Grade E     | 70  |
| Grade F     | 90  |
| Grade G     | 105 |
| Grade H     | 125 |
| Grade J     | 140 |
| Grade K     | 170 |
| Grade L     | 210 |
| Grade M     | 265 |
| Leather I   | 360 |
| Leather II  | 460 |
| Leather III | 560 |
| Leather IV  | 660 |
| Leather V   | 760 |
| Leather VI  | 860 |

**Upholstery Requires (Per Application):**

Fabric: 1¼ Yards  
Leather: 22½ Sq. Ft.

**Arm Upholstery:**

|             |     |
|-------------|-----|
| COM/COL     | 20  |
| Grade A     | 5   |
| Grade B     | 15  |
| Grade C     | 20  |
| Grade D     | 25  |
| Grade E     | 30  |
| Grade F     | 35  |
| Grade G     | 45  |
| Grade H     | 50  |
| Grade J     | 55  |
| Grade K     | 70  |
| Grade L     | 85  |
| Grade M     | 105 |
| Leather I   | 145 |
| Leather II  | 185 |
| Leather III | 225 |
| Leather IV  | 265 |
| Leather V   | 305 |
| Leather VI  | 345 |

**Upholstery Requires (Per Application):**

Fabric: ½ Yard  
Leather: 9 Sq. Ft.

**Seat Upholstery:**

|             |     |
|-------------|-----|
| COM/COL     | 30  |
| Grade A     | 10  |
| Grade B     | 20  |
| Grade C     | 30  |
| Grade D     | 45  |
| Grade E     | 55  |
| Grade F     | 65  |
| Grade G     | 85  |
| Grade H     | 100 |
| Grade J     | 110 |
| Grade K     | 130 |
| Grade L     | 165 |
| Grade M     | 210 |
| Leather I   | 285 |
| Leather II  | 365 |
| Leather III | 445 |
| Leather IV  | 525 |
| Leather V   | 605 |
| Leather VI  | 685 |

**Upholstery Requires (Per Application):**

Fabric: 1 Yard  
Leather: 18 Sq. Ft.

Base Price: 2910

**Total Required Upholstery:** Fabric: 2¾ Yards  
Leather: 49½ Sq. Ft.

PLEASE SPECIFY THE FOLLOWING TO ORDER:

|              |   |  |   |  |   |
|--------------|---|--|---|--|---|
| MODEL NUMBER | TEXTILES<br>Indicate fabric choice for:<br><br>Back upholstery<br><br><i>See options for fabrics at www.bbftextiles.com</i> | TEXTILES<br>Indicate fabric choice for:<br><br>Arm upholstery<br><br><i>See options for fabrics at www.bbftextiles.com</i> | TEXTILES<br>Indicate fabric choice for:<br><br>Seat upholstery<br><br><i>See options for fabrics at www.bbftextiles.com</i> | FLAMMABILITY<br>Indicate flammability:<br><br><b>U</b> = Cal 117 | CASTER<br><b>DWCM</b> = Double Wheel - Medium Casters<br><b>DWCS</b> = Double Wheel - Soft Casters +\$106 |
|--------------|---|--|---|--|---|

HST222-541.BackFabric.ArmFabric.SeatFabric.Flammability.Caster Example: HST222-541.950-88.950-88.950-88.U.DWCM





**Dimensions**

**Cadre HST222-551**



|    |         |     |         |
|----|---------|-----|---------|
| OH | 35½-39½ | AH  | 26½-30½ |
| OW | 24      | WBA | 19      |
| OD | 26      | DED |         |
| SH | 18½-22½ | DEW |         |
| SD | 19      | R   |         |

Shipping Weight 66  
Cube 20.4

Mid Back | Channel Stitched Upholstered Back and Seat | Polished Aluminum Arm with Upholstered Arm Cap |

ANSI/BIFMA LEVEL® Furniture Sustainability Standard certified  
Indoor Advantage™ certified

Synchronized Adjustments | Five-Prong Polished Aluminum Base | Double Wheel Casters

**Pricing for Single Fabric Placement:**

**Upholstery:**

|             |      |
|-------------|------|
| COM/COL     | 3125 |
| Grade A     | 3030 |
| Grade B     | 3075 |
| Grade C     | 3125 |
| Grade D     | 3170 |
| Grade E     | 3220 |
| Grade F     | 3275 |
| Grade G     | 3340 |
| Grade H     | 3405 |
| Grade J     | 3455 |
| Grade K     | 3550 |
| Grade L     | 3690 |
| Grade M     | 3880 |
| Leather I   | 4200 |
| Leather II  | 4540 |
| Leather III | 4880 |
| Leather IV  | 5220 |
| Leather V   | 5560 |
| Leather VI  | 5900 |

**Upholstery Requires:**

Fabric: 4¼ Yards  
Leather: 76½ Sq. Ft.

**Pricing for Multiple Fabric Placement:**

*(To Calculate, Begin with Base Price and add Upcharges)*

**Back Upholstery:**

|             |      |
|-------------|------|
| COM/COL     | 75   |
| Grade A     | 25   |
| Grade B     | 50   |
| Grade C     | 75   |
| Grade D     | 100  |
| Grade E     | 125  |
| Grade F     | 155  |
| Grade G     | 190  |
| Grade H     | 225  |
| Grade J     | 250  |
| Grade K     | 300  |
| Grade L     | 375  |
| Grade M     | 475  |
| Leather I   | 645  |
| Leather II  | 825  |
| Leather III | 1005 |
| Leather IV  | 1185 |
| Leather V   | 1365 |
| Leather VI  | 1545 |

**Upholstery Requires (Per Application):**

Fabric: 2¼ Yards  
Leather: 40½ Sq. Ft.

**Arm Upholstery:**

|             |     |
|-------------|-----|
| COM/COL     | 20  |
| Grade A     | 5   |
| Grade B     | 15  |
| Grade C     | 20  |
| Grade D     | 25  |
| Grade E     | 30  |
| Grade F     | 35  |
| Grade G     | 45  |
| Grade H     | 50  |
| Grade J     | 55  |
| Grade K     | 70  |
| Grade L     | 85  |
| Grade M     | 105 |
| Leather I   | 145 |
| Leather II  | 185 |
| Leather III | 225 |
| Leather IV  | 265 |
| Leather V   | 305 |
| Leather VI  | 345 |

**Upholstery Requires (Per Application):**

Fabric: ½ Yard  
Leather: 9 Sq. Ft.

**Seat Upholstery:**

|             |      |
|-------------|------|
| COM/COL     | 50   |
| Grade A     | 15   |
| Grade B     | 35   |
| Grade C     | 50   |
| Grade D     | 65   |
| Grade E     | 85   |
| Grade F     | 105  |
| Grade G     | 125  |
| Grade H     | 150  |
| Grade J     | 165  |
| Grade K     | 200  |
| Grade L     | 250  |
| Grade M     | 315  |
| Leather I   | 430  |
| Leather II  | 550  |
| Leather III | 670  |
| Leather IV  | 790  |
| Leather V   | 910  |
| Leather VI  | 1030 |

**Upholstery Requires (Per Application):**

Fabric: 1½ Yards  
Leather: 27 Sq. Ft.

Base Price: 2980

**Total Required**

**Upholstery:** Fabric: 4¼ Yards  
Leather: 76½ Sq. Ft.

PLEASE SPECIFY THE FOLLOWING TO ORDER:

|                            |  |   |  |  |   |
|----------------------------|--|---|--|--|---|
| <p><b>MODEL NUMBER</b></p> | <p><b>TEXTILES</b></p> <p>Indicate fabric choice for:</p> <p>Back upholstery</p> <p><i>See options for fabrics at <a href="http://www.hbftextiles.com">www.hbftextiles.com</a></i></p> | <p><b>TEXTILES</b></p> <p>Indicate fabric choice for:</p> <p>Arm upholstery</p> <p><i>See options for fabrics at <a href="http://www.hbftextiles.com">www.hbftextiles.com</a></i></p> | <p><b>TEXTILES</b></p> <p>Indicate fabric choice for:</p> <p>Seat upholstery</p> <p><i>See options for fabrics at <a href="http://www.hbftextiles.com">www.hbftextiles.com</a></i></p> | <p><b>FLAMMABILITY</b></p> <p>Indicate flammability:</p> <p><b>U</b> = Cal 117</p> | <p><b>CASTER</b></p> <p><b>DWCM</b> = Double Wheel - Medium Casters</p> <p><b>DWCS</b> = Double Wheel - Soft Casters +\$106</p> |
|----------------------------|--|---|--|--|---|

HST222-551.BackFabric.ArmFabric.SeatFabric.Flammability.Caster Example: HST222-551.950-88.950-88.950-88.U.DWCM



Dimensions

Cadre HST222-561



|                 |         |      |         |
|-----------------|---------|------|---------|
| OH              | 41½-44½ | AH   | 26½-30½ |
| OW              | 24      | WBA  | 19      |
| OD              | 26      | DED  |         |
| SH              | 18½-22½ | DEW  |         |
| SD              | 19      | R    |         |
| Shipping Weight |         | 66   |         |
| Cube            |         | 22.5 |         |

High Back | Channel Stitched Upholstered Back and Seat | Polished Aluminum Arm with Upholstered Arm Cap |

Synchronized Adjustments | Five-Prong Polished Aluminum Base | Double Wheel Casters

ANSI/BIFMA LEVEL® Furniture Sustainability Standard certified  
Indoor Advantage™ certified

**Pricing for Single Fabric Placement:**

**Upholstery:**

|             |      |
|-------------|------|
| COM/COL     | 3415 |
| Grade A     | 3330 |
| Grade B     | 3375 |
| Grade C     | 3415 |
| Grade D     | 3455 |
| Grade E     | 3500 |
| Grade F     | 3550 |
| Grade G     | 3605 |
| Grade H     | 3665 |
| Grade J     | 3705 |
| Grade K     | 3790 |
| Grade L     | 3915 |
| Grade M     | 4080 |
| Leather I   | 4365 |
| Leather II  | 4665 |
| Leather III | 4965 |
| Leather IV  | 5265 |
| Leather V   | 5565 |
| Leather VI  | 5865 |

**Upholstery Requires:**

Fabric: 3¾ Yards  
Leather: 67½ Sq. Ft.

**Pricing for Multiple Fabric Placement:**

*(To Calculate, Begin with Base Price and add Upcharges)*

**Back Upholstery:**

|             |      |
|-------------|------|
| COM/COL     | 55   |
| Grade A     | 20   |
| Grade B     | 35   |
| Grade C     | 55   |
| Grade D     | 75   |
| Grade E     | 95   |
| Grade F     | 120  |
| Grade G     | 145  |
| Grade H     | 175  |
| Grade J     | 195  |
| Grade K     | 230  |
| Grade L     | 290  |
| Grade M     | 370  |
| Leather I   | 500  |
| Leather II  | 640  |
| Leather III | 780  |
| Leather IV  | 920  |
| Leather V   | 1060 |
| Leather VI  | 1200 |

**Upholstery Requires (Per Application):**

Fabric: 1¾ Yards  
Leather: 31½ Sq. Ft.

**Arm Upholstery:**

|             |     |
|-------------|-----|
| COM/COL     | 20  |
| Grade A     | 5   |
| Grade B     | 15  |
| Grade C     | 20  |
| Grade D     | 25  |
| Grade E     | 30  |
| Grade F     | 35  |
| Grade G     | 45  |
| Grade H     | 50  |
| Grade J     | 55  |
| Grade K     | 70  |
| Grade L     | 85  |
| Grade M     | 105 |
| Leather I   | 145 |
| Leather II  | 185 |
| Leather III | 225 |
| Leather IV  | 265 |
| Leather V   | 305 |
| Leather VI  | 345 |

**Upholstery Requires (Per Application):**

Fabric: ½ Yard  
Leather: 9 Sq. Ft.

**Seat Upholstery:**

|             |      |
|-------------|------|
| COM/COL     | 50   |
| Grade A     | 15   |
| Grade B     | 35   |
| Grade C     | 50   |
| Grade D     | 65   |
| Grade E     | 85   |
| Grade F     | 105  |
| Grade G     | 125  |
| Grade H     | 150  |
| Grade J     | 165  |
| Grade K     | 200  |
| Grade L     | 250  |
| Grade M     | 315  |
| Leather I   | 430  |
| Leather II  | 550  |
| Leather III | 670  |
| Leather IV  | 790  |
| Leather V   | 910  |
| Leather VI  | 1030 |

**Upholstery Requires (Per Application):**

Fabric: 1½ Yards  
Leather: 27 Sq. Ft.

Base Price: 3290

**Total Required**

**Upholstery:** Fabric: 3¾ Yards  
Leather: 67½ Sq. Ft.

PLEASE SPECIFY THE FOLLOWING TO ORDER:

|                     |  |   |  |   |  |
|---------------------|--|---|--|---|--|
| <p>MODEL NUMBER</p> | <p>TEXTILES</p> <p>Indicate fabric choice for:</p> <p>Back upholstery</p> <p><i>See options for fabrics at www.hbftextiles.com</i></p> | <p>TEXTILES</p> <p>Indicate fabric choice for:</p> <p>Arm upholstery</p> <p><i>See options for fabrics at www.hbftextiles.com</i></p> | <p>TEXTILES</p> <p>Indicate fabric choice for:</p> <p>Seat upholstery</p> <p><i>See options for fabrics at www.hbftextiles.com</i></p> | <p>FLAMMABILITY</p> <p>Indicate flammability:</p> <p><b>U</b> = Cal 117</p> | <p>CASTER</p> <p><b>DWCM</b> = Double Wheel - Medium Casters</p> <p><b>DWCS</b> = Double Wheel - Soft Casters +\$106</p> |
|---------------------|--|---|--|---|--|

HST222-561.BackFabric.ArmFabric.SeatFabric.Flammability.Caster Example: HST222-561.950-88.950-88.950-88.U.DWCM



Dimensions

Cadre HST222-571



|    |         |     |         |
|----|---------|-----|---------|
| OH | 35½-39½ | AH  | 26½-30½ |
| OW | 24      | WBA | 19      |
| OD | 26      | DED |         |
| SH | 18½-22½ | DEW |         |
| SD | 19      | R   |         |

Shipping Weight 66  
Cube 20.4

Mid Back | Channel Stitched Upholstered Back and Seat | Full Polished Aluminum Wrap Around Arm with Upholstered Arm Cap |

Knee Tilt | Five-Prong Polished Aluminum Base | Double Wheel Casters

ANSI/BIFMA LEVEL® Furniture Sustainability Standard certified  
Indoor Advantage™ certified

**Pricing for Single Fabric Placement:**

**Upholstery:**

|             |      |
|-------------|------|
| COM/COL     | 3175 |
| Grade A     | 3080 |
| Grade B     | 3125 |
| Grade C     | 3175 |
| Grade D     | 3220 |
| Grade E     | 3270 |
| Grade F     | 3325 |
| Grade G     | 3390 |
| Grade H     | 3455 |
| Grade J     | 3505 |
| Grade K     | 3600 |
| Grade L     | 3740 |
| Grade M     | 3930 |
| Leather I   | 4250 |
| Leather II  | 4590 |
| Leather III | 4930 |
| Leather IV  | 5270 |
| Leather V   | 5610 |
| Leather VI  | 5950 |

**Upholstery Requires:**

Fabric: 4¼ Yards  
Leather: 76½ Sq. Ft.

**Pricing for Multiple Fabric Placement:**

*(To Calculate, Begin with Base Price and add Upcharges)*

**Back Upholstery:**

|             |      |
|-------------|------|
| COM/COL     | 75   |
| Grade A     | 25   |
| Grade B     | 50   |
| Grade C     | 75   |
| Grade D     | 100  |
| Grade E     | 125  |
| Grade F     | 155  |
| Grade G     | 190  |
| Grade H     | 225  |
| Grade J     | 250  |
| Grade K     | 300  |
| Grade L     | 375  |
| Grade M     | 475  |
| Leather I   | 645  |
| Leather II  | 825  |
| Leather III | 1005 |
| Leather IV  | 1185 |
| Leather V   | 1365 |
| Leather VI  | 1545 |

**Upholstery Requires (Per Application):**

Fabric: 2¼ Yards  
Leather: 40½ Sq. Ft.

**Arm Upholstery:**

|             |     |
|-------------|-----|
| COM/COL     | 20  |
| Grade A     | 5   |
| Grade B     | 15  |
| Grade C     | 20  |
| Grade D     | 25  |
| Grade E     | 30  |
| Grade F     | 35  |
| Grade G     | 45  |
| Grade H     | 50  |
| Grade J     | 55  |
| Grade K     | 70  |
| Grade L     | 85  |
| Grade M     | 105 |
| Leather I   | 145 |
| Leather II  | 185 |
| Leather III | 225 |
| Leather IV  | 265 |
| Leather V   | 305 |
| Leather VI  | 345 |

**Upholstery Requires (Per Application):**

Fabric: ½ Yard  
Leather: 9 Sq. Ft.

**Seat Upholstery:**

|             |      |
|-------------|------|
| COM/COL     | 50   |
| Grade A     | 15   |
| Grade B     | 35   |
| Grade C     | 50   |
| Grade D     | 65   |
| Grade E     | 85   |
| Grade F     | 105  |
| Grade G     | 125  |
| Grade H     | 150  |
| Grade J     | 165  |
| Grade K     | 200  |
| Grade L     | 250  |
| Grade M     | 315  |
| Leather I   | 430  |
| Leather II  | 550  |
| Leather III | 670  |
| Leather IV  | 790  |
| Leather V   | 910  |
| Leather VI  | 1030 |

**Upholstery Requires (Per Application):**

Fabric: 1½ Yards  
Leather: 27 Sq. Ft.

Base Price: 3030

**Total Required**

**Upholstery:** Fabric: 4¼ Yards  
Leather: 76½ Sq. Ft.

PLEASE SPECIFY THE FOLLOWING TO ORDER:

|              |   |  |   |  |   |
|--------------|---|--|---|--|---|
| MODEL NUMBER | TEXTILES<br>Indicate fabric choice for:<br><br>Back upholstery<br><br><i>See options for fabrics at www.hbftextiles.com</i> | TEXTILES<br>Indicate fabric choice for:<br><br>Arm upholstery<br><br><i>See options for fabrics at www.hbftextiles.com</i> | TEXTILES<br>Indicate fabric choice for:<br><br>Seat upholstery<br><br><i>See options for fabrics at www.hbftextiles.com</i> | FLAMMABILITY<br>Indicate flammability:<br><br><b>U</b> = Cal 117 | CASTER<br><b>DWCM</b> = Double Wheel - Medium Casters<br><b>DWCS</b> = Double Wheel - Soft Casters +\$106 |
|--------------|---|--|---|--|---|

HST222-571.BackFabric.ArmFabric.SeatFabric.Flammability.Caster Example: HST222-571.950-88.950-88.950-88.U.DWCM



Dimensions

Cadre HST222-581



|    |         |     |         |
|----|---------|-----|---------|
| OH | 41½-44½ | AH  | 26½-30½ |
| OW | 24      | WBA | 19      |
| OD | 26      | DED |         |
| SH | 18½-22½ | DEW |         |
| SD | 19      | R   |         |

Shipping Weight 66  
Cube 22.5

High Back | Channel Stitched Upholstered Back and Seat | Full Polished Aluminum Wrap Around Arm with Upholstered Arm Cap |  
Knee Tilt | Five-Prong Polished Aluminum Base | Double Wheel Casters

ANSI/BIFMA LEVEL® Furniture Sustainability Standard certified  
Indoor Advantage™ certified

**Pricing for Single Fabric Placement:**

**Upholstery:**

|             |      |
|-------------|------|
| COM/COL     | 3470 |
| Grade A     | 3385 |
| Grade B     | 3430 |
| Grade C     | 3470 |
| Grade D     | 3510 |
| Grade E     | 3555 |
| Grade F     | 3605 |
| Grade G     | 3660 |
| Grade H     | 3720 |
| Grade J     | 3760 |
| Grade K     | 3845 |
| Grade L     | 3970 |
| Grade M     | 4135 |
| Leather I   | 4420 |
| Leather II  | 4720 |
| Leather III | 5020 |
| Leather IV  | 5320 |
| Leather V   | 5620 |
| Leather VI  | 5920 |

**Upholstery Requires:**

Fabric: 3¾ Yards  
Leather: 67½ Sq. Ft.

**Pricing for Multiple Fabric Placement:**

*(To Calculate, Begin with Base Price and add Upcharges)*

**Back Upholstery:**

|             |      |
|-------------|------|
| COM/COL     | 55   |
| Grade A     | 20   |
| Grade B     | 35   |
| Grade C     | 55   |
| Grade D     | 75   |
| Grade E     | 95   |
| Grade F     | 120  |
| Grade G     | 145  |
| Grade H     | 175  |
| Grade J     | 195  |
| Grade K     | 230  |
| Grade L     | 290  |
| Grade M     | 370  |
| Leather I   | 500  |
| Leather II  | 640  |
| Leather III | 780  |
| Leather IV  | 920  |
| Leather V   | 1060 |
| Leather VI  | 1200 |

**Upholstery Requires (Per Application):**

Fabric: 1¾ Yards  
Leather: 31½ Sq. Ft.

**Arm Upholstery:**

|             |     |
|-------------|-----|
| COM/COL     | 20  |
| Grade A     | 5   |
| Grade B     | 15  |
| Grade C     | 20  |
| Grade D     | 25  |
| Grade E     | 30  |
| Grade F     | 35  |
| Grade G     | 45  |
| Grade H     | 50  |
| Grade J     | 55  |
| Grade K     | 70  |
| Grade L     | 85  |
| Grade M     | 105 |
| Leather I   | 145 |
| Leather II  | 185 |
| Leather III | 225 |
| Leather IV  | 265 |
| Leather V   | 305 |
| Leather VI  | 345 |

**Upholstery Requires (Per Application):**

Fabric: ½ Yard  
Leather: 9 Sq. Ft.

**Seat Upholstery:**

|             |      |
|-------------|------|
| COM/COL     | 50   |
| Grade A     | 15   |
| Grade B     | 35   |
| Grade C     | 50   |
| Grade D     | 65   |
| Grade E     | 85   |
| Grade F     | 105  |
| Grade G     | 125  |
| Grade H     | 150  |
| Grade J     | 165  |
| Grade K     | 200  |
| Grade L     | 250  |
| Grade M     | 315  |
| Leather I   | 430  |
| Leather II  | 550  |
| Leather III | 670  |
| Leather IV  | 790  |
| Leather V   | 910  |
| Leather VI  | 1030 |

**Upholstery Requires (Per Application):**

Fabric: 1½ Yards  
Leather: 27 Sq. Ft.

Base Price: 3345

**Total Required**

**Upholstery:** Fabric: 3¾ Yards  
Leather: 67½ Sq. Ft.

PLEASE SPECIFY THE FOLLOWING TO ORDER:

|                     |   |  |   |   |  |
|---------------------|---|--|---|---|--|
| <p>MODEL NUMBER</p> | <p>TEXTILES</p> <p>Indicate fabric choice for:</p> <p>Back upholstery</p> <p><i>See options for fabrics at <a href="http://www.hbftextiles.com">www.hbftextiles.com</a></i></p> | <p>TEXTILES</p> <p>Indicate fabric choice for:</p> <p>Arm upholstery</p> <p><i>See options for fabrics at <a href="http://www.hbftextiles.com">www.hbftextiles.com</a></i></p> | <p>TEXTILES</p> <p>Indicate fabric choice for:</p> <p>Seat upholstery</p> <p><i>See options for fabrics at <a href="http://www.hbftextiles.com">www.hbftextiles.com</a></i></p> | <p>FLAMMABILITY</p> <p>Indicate flammability:</p> <p><b>U</b> = Cal 117</p> | <p>CASTER</p> <p><b>DWCM</b> = Double Wheel - Medium Casters</p> <p><b>DWCS</b> = Double Wheel - Soft Casters +\$106</p> |
|---------------------|---|--|---|---|--|

HST222-581.BackFabric.ArmFabric.SeatFabric.Flammability.Caster Example: HST222-581.950-88.950-88.950-88.U.DWCM



Dimensions

Cadre HST222-111



|    |         |     |         |
|----|---------|-----|---------|
| OH | 35½-39½ | AH  | 26½-30½ |
| OW | 24      | WBA | 19      |
| OD | 26      | DED |         |
| SH | 18½-22½ | DEW |         |
| SD | 19      | R   |         |

|                 |      |
|-----------------|------|
| Shipping Weight | 66   |
| Cube            | 20.4 |

Mid Back | Upholstered Back and Seat | Black Arm with Urethane Arm Cap | Five-Prong Black Metal Base |

Synchronized Adjustments | Double Wheel Casters

ANSI/BIFMA LEVEL® Furniture Sustainability Standard certified  
Indoor Advantage™ certified

**Pricing for Single Fabric Placement:**

**Upholstery:**

|             |      |
|-------------|------|
| COM/COL     | 2485 |
| Grade A     | 2445 |
| Grade B     | 2465 |
| Grade C     | 2485 |
| Grade D     | 2515 |
| Grade E     | 2535 |
| Grade F     | 2555 |
| Grade G     | 2595 |
| Grade H     | 2625 |
| Grade J     | 2645 |
| Grade K     | 2685 |
| Grade L     | 2755 |
| Grade M     | 2845 |
| Leather I   | 2995 |
| Leather II  | 3155 |
| Leather III | 3315 |
| Leather IV  | 3475 |
| Leather V   | 3635 |
| Leather VI  | 3795 |

**Upholstery Requires:**

|             |         |
|-------------|---------|
| Fabric: 2   | Yards   |
| Leather: 36 | Sq. Ft. |

**Pricing for Multiple Fabric Placement:**

*(To Calculate, Begin with Base Price and add Upcharges)*

**Back Upholstery:**

|             |     |
|-------------|-----|
| COM/COL     | 30  |
| Grade A     | 10  |
| Grade B     | 20  |
| Grade C     | 30  |
| Grade D     | 45  |
| Grade E     | 55  |
| Grade F     | 65  |
| Grade G     | 85  |
| Grade H     | 100 |
| Grade J     | 110 |
| Grade K     | 130 |
| Grade L     | 165 |
| Grade M     | 210 |
| Leather I   | 285 |
| Leather II  | 365 |
| Leather III | 445 |
| Leather IV  | 525 |
| Leather V   | 605 |
| Leather VI  | 685 |

**Upholstery Requires (Per Application):**

|             |         |
|-------------|---------|
| Fabric: 1   | Yard    |
| Leather: 18 | Sq. Ft. |

**Seat Upholstery:**

|             |     |
|-------------|-----|
| COM/COL     | 30  |
| Grade A     | 10  |
| Grade B     | 20  |
| Grade C     | 30  |
| Grade D     | 45  |
| Grade E     | 55  |
| Grade F     | 65  |
| Grade G     | 85  |
| Grade H     | 100 |
| Grade J     | 110 |
| Grade K     | 130 |
| Grade L     | 165 |
| Grade M     | 210 |
| Leather I   | 285 |
| Leather II  | 365 |
| Leather III | 445 |
| Leather IV  | 525 |
| Leather V   | 605 |
| Leather VI  | 685 |

**Upholstery Requires (Per Application):**

|             |         |
|-------------|---------|
| Fabric: 1   | Yard    |
| Leather: 18 | Sq. Ft. |

Base Price: 2425

**Total Required**

**Upholstery:** Fabric: 2 Yards  
Leather: 36 Sq. Ft.

PLEASE SPECIFY THE FOLLOWING TO ORDER:

|                            |  |  |  |   |
|----------------------------|--|--|--|---|
| <p><b>MODEL NUMBER</b></p> | <p><b>TEXTILES</b></p> <p>Indicate fabric choice for:</p> <p>Back upholstery</p> <p><i>See options for fabrics at <a href="http://www.bbftextiles.com">www.bbftextiles.com</a></i></p> | <p><b>TEXTILES</b></p> <p>Indicate fabric choice for:</p> <p>Seat upholstery</p> <p><i>See options for fabrics at <a href="http://www.bbftextiles.com">www.bbftextiles.com</a></i></p> | <p><b>FLAMMABILITY</b></p> <p>Indicate flammability:</p> <p><b>U</b> = Cal 117</p> | <p><b>CASTER</b></p> <p><b>DWCM</b> = Double Wheel - Medium Casters</p> <p><b>DWCS</b> = Double Wheel - Soft Casters +\$106</p> |
|----------------------------|--|--|--|---|

HST222-111.BackFabric.SeatFabric.Flammability.Caster Example: HST222-111.950-88.950-88.U.DWCM



Dimensions

Cadre HST222-121



|    |         |     |         |
|----|---------|-----|---------|
| OH | 41½-44½ | AH  | 26½-30½ |
| OW | 24      | WBA | 19      |
| OD | 26      | DED |         |
| SH | 18½-22½ | DEW |         |
| SD | 19      | R   |         |

Shipping Weight 66  
Cube 22.5

High Back | Upholstered Back and Seat | Black Arm with Urethane Arm Cap | Five-Prong Black Metal Base |

Synchronized Adjustments | Double Wheel Casters

ANSI/BIFMA LEVEL® Furniture Sustainability Standard certified  
Indoor Advantage™ certified

**Pricing for Single Fabric Placement:**

**Upholstery:**

|             |      |
|-------------|------|
| COM/COL     | 2830 |
| Grade A     | 2780 |
| Grade B     | 2805 |
| Grade C     | 2830 |
| Grade D     | 2855 |
| Grade E     | 2880 |
| Grade F     | 2910 |
| Grade G     | 2945 |
| Grade H     | 2980 |
| Grade J     | 3005 |
| Grade K     | 3055 |
| Grade L     | 3130 |
| Grade M     | 3230 |
| Leather I   | 3400 |
| Leather II  | 3580 |
| Leather III | 3760 |
| Leather IV  | 3940 |
| Leather V   | 4120 |
| Leather VI  | 4300 |

**Upholstery Requires:**

Fabric: 2¼ Yards  
Leather: 40½ Sq. Ft.

**Pricing for Multiple Fabric Placement:**

*(To Calculate, Begin with Base Price and add Upcharges)*

**Back Upholstery:**

|             |     |
|-------------|-----|
| COM/COL     | 45  |
| Grade A     | 15  |
| Grade B     | 30  |
| Grade C     | 45  |
| Grade D     | 55  |
| Grade E     | 70  |
| Grade F     | 90  |
| Grade G     | 105 |
| Grade H     | 125 |
| Grade J     | 140 |
| Grade K     | 170 |
| Grade L     | 210 |
| Grade M     | 265 |
| Leather I   | 360 |
| Leather II  | 460 |
| Leather III | 560 |
| Leather IV  | 660 |
| Leather V   | 760 |
| Leather VI  | 860 |

**Upholstery Requires (Per Application):**

Fabric: 1¼ Yards  
Leather: 22½ Sq. Ft.

**Seat Upholstery:**

|             |     |
|-------------|-----|
| COM/COL     | 30  |
| Grade A     | 10  |
| Grade B     | 20  |
| Grade C     | 30  |
| Grade D     | 45  |
| Grade E     | 55  |
| Grade F     | 65  |
| Grade G     | 85  |
| Grade H     | 100 |
| Grade J     | 110 |
| Grade K     | 130 |
| Grade L     | 165 |
| Grade M     | 210 |
| Leather I   | 285 |
| Leather II  | 365 |
| Leather III | 445 |
| Leather IV  | 525 |
| Leather V   | 605 |
| Leather VI  | 685 |

**Upholstery Requires (Per Application):**

Fabric: 1 Yard  
Leather: 18 Sq. Ft.

Base Price: 2755

**Total Required**

**Upholstery:** Fabric: 2¼ Yards  
Leather: 40½ Sq. Ft.

PLEASE SPECIFY THE FOLLOWING TO ORDER:

|                            |  |  |  |   |
|----------------------------|--|--|--|---|
| <p><b>MODEL NUMBER</b></p> | <p><b>TEXTILES</b></p> <p>Indicate fabric choice for:</p> <p>Back upholstery</p> <p><i>See options for fabrics at <a href="http://www.bbftextiles.com">www.bbftextiles.com</a></i></p> | <p><b>TEXTILES</b></p> <p>Indicate fabric choice for:</p> <p>Seat upholstery</p> <p><i>See options for fabrics at <a href="http://www.bbftextiles.com">www.bbftextiles.com</a></i></p> | <p><b>FLAMMABILITY</b></p> <p>Indicate flammability:</p> <p><b>U</b> = Cal 117</p> | <p><b>CASTER</b></p> <p><b>DWCM</b> = Double Wheel - Medium Casters</p> <p><b>DWCS</b> = Double Wheel - Soft Casters +\$106</p> |
|----------------------------|--|--|--|---|

HST222-121.BackFabric.SeatFabric.Flammability.Caster Example: HST222-121.950-88.950-88.U.DWCM



Dimensions

Cadre HST222-131



|    |         |     |         |
|----|---------|-----|---------|
| OH | 35½-39½ | AH  | 26½-30½ |
| OW | 24      | WBA | 19      |
| OD | 26      | DED |         |
| SH | 18½-22½ | DEW |         |
| SD | 19      | R   |         |

|                 |      |
|-----------------|------|
| Shipping Weight | 66   |
| Cube            | 20.4 |

Mid Back | Upholstered Back and Seat | Full Black Wrap Around Arm with Urethane Arm Cap |

Five-Prong Black Metal Base | Knee Tilt Adjustments | Double Wheel Casters

ANSI/BIFMA LEVEL® Furniture Sustainability Standard certified  
Indoor Advantage™ certified

**Pricing for Single Fabric Placement:**

**Upholstery:**

|             |      |
|-------------|------|
| COM/COL     | 2500 |
| Grade A     | 2460 |
| Grade B     | 2480 |
| Grade C     | 2500 |
| Grade D     | 2530 |
| Grade E     | 2550 |
| Grade F     | 2570 |
| Grade G     | 2610 |
| Grade H     | 2640 |
| Grade J     | 2660 |
| Grade K     | 2700 |
| Grade L     | 2770 |
| Grade M     | 2860 |
| Leather I   | 3010 |
| Leather II  | 3170 |
| Leather III | 3330 |
| Leather IV  | 3490 |
| Leather V   | 3650 |
| Leather VI  | 3810 |

**Upholstery Requires:**

Fabric: 2 Yards  
Leather: 36 Sq. Ft.

**Pricing for Multiple Fabric Placement:**

*(To Calculate, Begin with Base Price and add Upcharges)*

**Back Upholstery:**

|             |     |
|-------------|-----|
| COM/COL     | 30  |
| Grade A     | 10  |
| Grade B     | 20  |
| Grade C     | 30  |
| Grade D     | 45  |
| Grade E     | 55  |
| Grade F     | 65  |
| Grade G     | 85  |
| Grade H     | 100 |
| Grade J     | 110 |
| Grade K     | 130 |
| Grade L     | 165 |
| Grade M     | 210 |
| Leather I   | 285 |
| Leather II  | 365 |
| Leather III | 445 |
| Leather IV  | 525 |
| Leather V   | 605 |
| Leather VI  | 685 |

**Upholstery Requires (Per Application):**

Fabric: 1 Yard  
Leather: 18 Sq. Ft.

**Seat Upholstery:**

|             |     |
|-------------|-----|
| COM/COL     | 30  |
| Grade A     | 10  |
| Grade B     | 20  |
| Grade C     | 30  |
| Grade D     | 45  |
| Grade E     | 55  |
| Grade F     | 65  |
| Grade G     | 85  |
| Grade H     | 100 |
| Grade J     | 110 |
| Grade K     | 130 |
| Grade L     | 165 |
| Grade M     | 210 |
| Leather I   | 285 |
| Leather II  | 365 |
| Leather III | 445 |
| Leather IV  | 525 |
| Leather V   | 605 |
| Leather VI  | 685 |

**Upholstery Requires (Per Application):**

Fabric: 1 Yard  
Leather: 18 Sq. Ft.

Base Price: 2440

**Total Required**

**Upholstery:** Fabric: 2 Yards  
Leather: 36 Sq. Ft.

PLEASE SPECIFY THE FOLLOWING TO ORDER:

|                            |  |  |  |   |
|----------------------------|--|--|--|---|
| <p><b>MODEL NUMBER</b></p> | <p><b>TEXTILES</b></p> <p>Indicate fabric choice for:</p> <p>Back upholstery</p> <p><i>See options for fabrics at <a href="http://www.bbf textiles.com">www.bbf textiles.com</a></i></p> | <p><b>TEXTILES</b></p> <p>Indicate fabric choice for:</p> <p>Seat upholstery</p> <p><i>See options for fabrics at <a href="http://www.bbf textiles.com">www.bbf textiles.com</a></i></p> | <p><b>FLAMMABILITY</b></p> <p>Indicate flammability:</p> <p><b>U</b> = Cal 117</p> | <p><b>CASTER</b></p> <p><b>DWCM</b> = Double Wheel - Medium Casters</p> <p><b>DWCS</b> = Double Wheel - Soft Casters +\$106</p> |
|----------------------------|--|--|--|---|

HST222-131.BackFabric.SeatFabric.Flammability.Caster Example: HST222-131.950-88.950-88.U.DWCM



Dimensions

Cadre HST222-141



|    |         |     |         |
|----|---------|-----|---------|
| OH | 41½-44½ | AH  | 26½-30½ |
| OW | 24      | WBA | 19      |
| OD | 26      | DED |         |
| SH | 18½-22½ | DEW |         |
| SD | 19      | R   |         |

Shipping Weight 66  
Cube 22.5

High Back | Upholstered Back and Seat | Full Black Wrap Around Arm with Urethane Arm Cap |

Five-Prong Black Metal Base | Knee Tilt Adjustments | Double Wheel Casters

ANSI/BIFMA LEVEL® Furniture Sustainability Standard certified  
Indoor Advantage™ certified

**Pricing for Single Fabric Placement:**

**Upholstery:**

|             |      |
|-------------|------|
| COM/COL     | 2850 |
| Grade A     | 2800 |
| Grade B     | 2825 |
| Grade C     | 2850 |
| Grade D     | 2875 |
| Grade E     | 2900 |
| Grade F     | 2930 |
| Grade G     | 2965 |
| Grade H     | 3000 |
| Grade J     | 3025 |
| Grade K     | 3075 |
| Grade L     | 3150 |
| Grade M     | 3250 |
| Leather I   | 3420 |
| Leather II  | 3600 |
| Leather III | 3780 |
| Leather IV  | 3960 |
| Leather V   | 4140 |
| Leather VI  | 4320 |

**Upholstery Requires:**

Fabric: 2¼ Yards  
Leather: 40½ Sq. Ft.

**Pricing for Multiple Fabric Placement:**

*(To Calculate, Begin with Base Price and add Upcharges)*

**Back Upholstery:**

|             |     |
|-------------|-----|
| COM/COL     | 45  |
| Grade A     | 15  |
| Grade B     | 30  |
| Grade C     | 45  |
| Grade D     | 55  |
| Grade E     | 70  |
| Grade F     | 90  |
| Grade G     | 105 |
| Grade H     | 125 |
| Grade J     | 140 |
| Grade K     | 170 |
| Grade L     | 210 |
| Grade M     | 265 |
| Leather I   | 360 |
| Leather II  | 460 |
| Leather III | 560 |
| Leather IV  | 660 |
| Leather V   | 760 |
| Leather VI  | 860 |

**Upholstery Requires (Per Application):**

Fabric: 1¼ Yards  
Leather: 22½ Sq. Ft.

**Seat Upholstery:**

|             |     |
|-------------|-----|
| COM/COL     | 30  |
| Grade A     | 10  |
| Grade B     | 20  |
| Grade C     | 30  |
| Grade D     | 45  |
| Grade E     | 55  |
| Grade F     | 65  |
| Grade G     | 85  |
| Grade H     | 100 |
| Grade J     | 110 |
| Grade K     | 130 |
| Grade L     | 165 |
| Grade M     | 210 |
| Leather I   | 285 |
| Leather II  | 365 |
| Leather III | 445 |
| Leather IV  | 525 |
| Leather V   | 605 |
| Leather VI  | 685 |

**Upholstery Requires (Per Application):**

Fabric: 1 Yard  
Leather: 18 Sq. Ft.

Base Price: 2775

**Total Required**

**Upholstery:** Fabric: 2¼ Yards  
Leather: 40½ Sq. Ft.

PLEASE SPECIFY THE FOLLOWING TO ORDER:

|                            |  |  |  |   |
|----------------------------|--|--|--|---|
| <p><b>MODEL NUMBER</b></p> | <p><b>TEXTILES</b></p> <p>Indicate fabric choice for:</p> <p>Back upholstery</p> <p><i>See options for fabrics at <a href="http://www.bbftextiles.com">www.bbftextiles.com</a></i></p> | <p><b>TEXTILES</b></p> <p>Indicate fabric choice for:</p> <p>Seat upholstery</p> <p><i>See options for fabrics at <a href="http://www.bbftextiles.com">www.bbftextiles.com</a></i></p> | <p><b>FLAMMABILITY</b></p> <p>Indicate flammability:</p> <p><b>U</b> = Cal 117</p> | <p><b>CASTER</b></p> <p><b>DWCM</b> = Double Wheel - Medium Casters</p> <p><b>DWCS</b> = Double Wheel - Soft Casters +\$106</p> |
|----------------------------|--|--|--|---|

HST222-141.BackFabric.SeatFabric.Flammability.Caster Example: HST222-141.950-88.950-88.U.DWCM





**Dimensions**

**Cadre HST222-151**



|                 |         |      |         |
|-----------------|---------|------|---------|
| OH              | 35½-39½ | AH   | 26½-30½ |
| OW              | 24      | WBA  | 19      |
| OD              | 26      | DED  |         |
| SH              | 18½-22½ | DEW  |         |
| SD              | 19      | R    |         |
| Shipping Weight |         | 66   |         |
| Cube            |         | 20.4 |         |

Mid Back | Channel Stitched Upholstered Back and Seat | Black Arm with Urethane Arm Cap | Five-Prong Black Metal Base |

Synchronized Adjustments | Double Wheel Casters

ANSI/BIFMA LEVEL® Furniture Sustainability Standard certified  
Indoor Advantage™ certified

**Pricing for Single Fabric Placement:**

**Upholstery:**

|             |      |
|-------------|------|
| COM/COL     | 2995 |
| Grade A     | 2910 |
| Grade B     | 2955 |
| Grade C     | 2995 |
| Grade D     | 3035 |
| Grade E     | 3080 |
| Grade F     | 3130 |
| Grade G     | 3185 |
| Grade H     | 3245 |
| Grade J     | 3285 |
| Grade K     | 3370 |
| Grade L     | 3495 |
| Grade M     | 3660 |
| Leather I   | 3945 |
| Leather II  | 4245 |
| Leather III | 4545 |
| Leather IV  | 4845 |
| Leather V   | 5145 |
| Leather VI  | 5445 |

**Upholstery Requires:**

Fabric: 3¾ Yards  
Leather: 67½ Sq. Ft.

**Pricing for Multiple Fabric Placement:**

*(To Calculate, Begin with Base Price and add Upcharges)*

**Back Upholstery:**

|             |      |
|-------------|------|
| COM/COL     | 75   |
| Grade A     | 25   |
| Grade B     | 50   |
| Grade C     | 75   |
| Grade D     | 100  |
| Grade E     | 125  |
| Grade F     | 155  |
| Grade G     | 190  |
| Grade H     | 225  |
| Grade J     | 250  |
| Grade K     | 300  |
| Grade L     | 375  |
| Grade M     | 475  |
| Leather I   | 645  |
| Leather II  | 825  |
| Leather III | 1005 |
| Leather IV  | 1185 |
| Leather V   | 1365 |
| Leather VI  | 1545 |

**Upholstery Requires (Per Application):**

Fabric: 2¼ Yards  
Leather: 40½ Sq. Ft.

**Seat Upholstery:**

|             |      |
|-------------|------|
| COM/COL     | 50   |
| Grade A     | 15   |
| Grade B     | 35   |
| Grade C     | 50   |
| Grade D     | 65   |
| Grade E     | 85   |
| Grade F     | 105  |
| Grade G     | 125  |
| Grade H     | 150  |
| Grade J     | 165  |
| Grade K     | 200  |
| Grade L     | 250  |
| Grade M     | 315  |
| Leather I   | 430  |
| Leather II  | 550  |
| Leather III | 670  |
| Leather IV  | 790  |
| Leather V   | 910  |
| Leather VI  | 1030 |

**Upholstery Requires (Per Application):**

Fabric: 1½ Yards  
Leather: 27 Sq. Ft.

**Base Price:** 2870

**Total Required**

**Upholstery:** Fabric: 3¾ Yards  
Leather: 67½ Sq. Ft.

PLEASE SPECIFY THE FOLLOWING TO ORDER:

|                            |  |  |  |   |
|----------------------------|--|--|--|---|
| <p><b>MODEL NUMBER</b></p> | <p><b>TEXTILES</b></p> <p>Indicate fabric choice for:</p> <p>Back upholstery</p> <p><i>See options for fabrics at <a href="http://www.bbftextiles.com">www.bbftextiles.com</a></i></p> | <p><b>TEXTILES</b></p> <p>Indicate fabric choice for:</p> <p>Seat upholstery</p> <p><i>See options for fabrics at <a href="http://www.bbftextiles.com">www.bbftextiles.com</a></i></p> | <p><b>FLAMMABILITY</b></p> <p>Indicate flammability:</p> <p><b>U</b> = Cal 117</p> | <p><b>CASTER</b></p> <p><b>DWCM</b> = Double Wheel - Medium Casters</p> <p><b>DWCS</b> = Double Wheel - Soft Casters +\$106</p> |
|----------------------------|--|--|--|---|

HST222-151.BackFabric.SeatFabric.Flammability.Caster Example: HST222-151.950-88.950-88.U.DWCM



**Dimensions**

**Cadre HST222-161**



|    |         |     |         |
|----|---------|-----|---------|
| OH | 41½-44½ | AH  | 26½-30½ |
| OW | 24      | WBA | 19      |
| OD | 26      | DED |         |
| SH | 18½-22½ | DEW |         |
| SD | 19      | R   |         |

Shipping Weight 66  
Cube 22.5

High Back | Channel Stitched Upholstered Back and Seat | Black Arm with Urethane Arm Cap | Five-Prong Black Metal Base |

Synchronized Adjustments | Double Wheel Casters

ANSI/BIFMA LEVEL® Furniture Sustainability Standard certified  
Indoor Advantage™ certified

**Pricing for Single Fabric Placement:**

**Upholstery:**

|             |      |
|-------------|------|
| COM/COL     | 3285 |
| Grade A     | 3215 |
| Grade B     | 3250 |
| Grade C     | 3285 |
| Grade D     | 3325 |
| Grade E     | 3360 |
| Grade F     | 3400 |
| Grade G     | 3455 |
| Grade H     | 3505 |
| Grade J     | 3540 |
| Grade K     | 3610 |
| Grade L     | 3720 |
| Grade M     | 3865 |
| Leather I   | 4110 |
| Leather II  | 4370 |
| Leather III | 4630 |
| Leather IV  | 4890 |
| Leather V   | 5150 |
| Leather VI  | 5410 |

**Upholstery Requires:**

Fabric: 3¼ Yards  
Leather: 58½ Sq. Ft.

**Pricing for Multiple Fabric Placement:**

*(To Calculate, Begin with Base Price and add Upcharges)*

**Back Upholstery:**

|             |      |
|-------------|------|
| COM/COL     | 55   |
| Grade A     | 20   |
| Grade B     | 35   |
| Grade C     | 55   |
| Grade D     | 75   |
| Grade E     | 95   |
| Grade F     | 120  |
| Grade G     | 145  |
| Grade H     | 175  |
| Grade J     | 195  |
| Grade K     | 230  |
| Grade L     | 290  |
| Grade M     | 370  |
| Leather I   | 500  |
| Leather II  | 640  |
| Leather III | 780  |
| Leather IV  | 920  |
| Leather V   | 1060 |
| Leather VI  | 1200 |

**Upholstery Requires (Per Application):**

Fabric: 1¾ Yards  
Leather: 31½ Sq. Ft.

**Seat Upholstery:**

|             |      |
|-------------|------|
| COM/COL     | 50   |
| Grade A     | 15   |
| Grade B     | 35   |
| Grade C     | 50   |
| Grade D     | 65   |
| Grade E     | 85   |
| Grade F     | 105  |
| Grade G     | 125  |
| Grade H     | 150  |
| Grade J     | 165  |
| Grade K     | 200  |
| Grade L     | 250  |
| Grade M     | 315  |
| Leather I   | 430  |
| Leather II  | 550  |
| Leather III | 670  |
| Leather IV  | 790  |
| Leather V   | 910  |
| Leather VI  | 1030 |

**Upholstery Requires (Per Application):**

Fabric: 1½ Yards  
Leather: 27 Sq. Ft.

Base Price: 3180

**Total Required**

**Upholstery:** Fabric: 3¼ Yards  
Leather: 58½ Sq. Ft.

PLEASE SPECIFY THE FOLLOWING TO ORDER:

|                            |  |  |  |   |
|----------------------------|--|--|--|---|
| <p><b>MODEL NUMBER</b></p> | <p><b>TEXTILES</b></p> <p>Indicate fabric choice for:</p> <p>Back upholstery</p> <p><i>See options for fabrics at <a href="http://www.bbftextiles.com">www.bbftextiles.com</a></i></p> | <p><b>TEXTILES</b></p> <p>Indicate fabric choice for:</p> <p>Seat upholstery</p> <p><i>See options for fabrics at <a href="http://www.bbftextiles.com">www.bbftextiles.com</a></i></p> | <p><b>FLAMMABILITY</b></p> <p>Indicate flammability:</p> <p><b>U</b> = Cal 117</p> | <p><b>CASTER</b></p> <p><b>DWCM</b> = Double Wheel - Medium Casters</p> <p><b>DWCS</b> = Double Wheel - Soft Casters +\$106</p> |
|----------------------------|--|--|--|---|

HST222-161.BackFabric.SeatFabric.Flammability.Caster Example: HST222-161.950-88.950-88.U.DWCM



**Dimensions**

**Cadre HST222-171**



|    |         |     |         |
|----|---------|-----|---------|
| OH | 35½-39½ | AH  | 26½-30½ |
| OW | 24      | WBA | 19      |
| OD | 26      | DED |         |
| SH | 18½-22½ | DEW |         |
| SD | 19      | R   |         |

Shipping Weight 66  
Cube 20.4

Mid Back | Channel Stitched Upholstered Back and Seat | Full Black Wrap Around Arm with Urethane Arm Cap |

Five-Prong Black Metal Base | Knee Tilt | Double Wheel Casters

ANSI/BIFMA LEVEL® Furniture Sustainability Standard certified  
Indoor Advantage™ certified

**Pricing for Single Fabric Placement:**

**Upholstery:**

|             |      |
|-------------|------|
| COM/COL     | 3015 |
| Grade A     | 2930 |
| Grade B     | 2975 |
| Grade C     | 3015 |
| Grade D     | 3055 |
| Grade E     | 3100 |
| Grade F     | 3150 |
| Grade G     | 3205 |
| Grade H     | 3265 |
| Grade J     | 3305 |
| Grade K     | 3390 |
| Grade L     | 3515 |
| Grade M     | 3680 |
| Leather I   | 3965 |
| Leather II  | 4265 |
| Leather III | 4565 |
| Leather IV  | 4865 |
| Leather V   | 5165 |
| Leather VI  | 5465 |

**Upholstery Requires:**

Fabric: 3¾ Yards  
Leather: 67½ Sq. Ft.

**Pricing for Multiple Fabric Placement:**

*(To Calculate, Begin with Base Price and add Upcharges)*

**Back Upholstery:**

|             |      |
|-------------|------|
| COM/COL     | 75   |
| Grade A     | 25   |
| Grade B     | 50   |
| Grade C     | 75   |
| Grade D     | 100  |
| Grade E     | 125  |
| Grade F     | 155  |
| Grade G     | 190  |
| Grade H     | 225  |
| Grade J     | 250  |
| Grade K     | 300  |
| Grade L     | 375  |
| Grade M     | 475  |
| Leather I   | 645  |
| Leather II  | 825  |
| Leather III | 1005 |
| Leather IV  | 1185 |
| Leather V   | 1365 |
| Leather VI  | 1545 |

**Upholstery Requires (Per Application):**

Fabric: 2¼ Yards  
Leather: 40½ Sq. Ft.

**Seat Upholstery:**

|             |      |
|-------------|------|
| COM/COL     | 50   |
| Grade A     | 15   |
| Grade B     | 35   |
| Grade C     | 50   |
| Grade D     | 65   |
| Grade E     | 85   |
| Grade F     | 105  |
| Grade G     | 125  |
| Grade H     | 150  |
| Grade J     | 165  |
| Grade K     | 200  |
| Grade L     | 250  |
| Grade M     | 315  |
| Leather I   | 430  |
| Leather II  | 550  |
| Leather III | 670  |
| Leather IV  | 790  |
| Leather V   | 910  |
| Leather VI  | 1030 |

**Upholstery Requires (Per Application):**

Fabric: 1½ Yards  
Leather: 27 Sq. Ft.

Base Price: 2890

**Total Required**

**Upholstery:** Fabric: 3¾ Yards  
Leather: 67½ Sq. Ft.

PLEASE SPECIFY THE FOLLOWING TO ORDER:

|                            |  |  |  |   |
|----------------------------|--|--|--|---|
| <p><b>MODEL NUMBER</b></p> | <p><b>TEXTILES</b></p> <p>Indicate fabric choice for:</p> <p>Back upholstery</p> <p><i>See options for fabrics at <a href="http://www.bbftextiles.com">www.bbftextiles.com</a></i></p> | <p><b>TEXTILES</b></p> <p>Indicate fabric choice for:</p> <p>Seat upholstery</p> <p><i>See options for fabrics at <a href="http://www.bbftextiles.com">www.bbftextiles.com</a></i></p> | <p><b>FLAMMABILITY</b></p> <p>Indicate flammability:</p> <p><b>U</b> = Cal 117</p> | <p><b>CASTER</b></p> <p><b>DWCM</b> = Double Wheel - Medium Casters</p> <p><b>DWCS</b> = Double Wheel - Soft Casters +\$106</p> |
|----------------------------|--|--|--|---|

HST222-171.BackFabric.SeatFabric.Flammability.Caster Example: HST222-171.950-88.950-88.U.DWCM



**Dimensions**

**Cadre HST222-181**



|    |         |     |         |
|----|---------|-----|---------|
| OH | 41½-44½ | AH  | 26½-30½ |
| OW | 24      | WBA | 19      |
| OD | 26      | DED |         |
| SH | 18½-22½ | DEW |         |
| SD | 19      | R   |         |

Shipping Weight 66  
Cube 22.5

High Back | Channel Stitched Upholstered Back and Seat | Full Black Wrap Around Arm with Urethane Arm Cap |

Five-Prong Black Metal Base | Knee Tilt | Double Wheel Casters

ANSI/BIFMA LEVEL® Furniture Sustainability Standard certified  
Indoor Advantage™ certified

**Pricing for Single Fabric Placement:**

**Upholstery:**

|             |      |
|-------------|------|
| COM/COL     | 3310 |
| Grade A     | 3240 |
| Grade B     | 3275 |
| Grade C     | 3310 |
| Grade D     | 3350 |
| Grade E     | 3385 |
| Grade F     | 3425 |
| Grade G     | 3480 |
| Grade H     | 3530 |
| Grade J     | 3565 |
| Grade K     | 3635 |
| Grade L     | 3745 |
| Grade M     | 3890 |
| Leather I   | 4135 |
| Leather II  | 4395 |
| Leather III | 4655 |
| Leather IV  | 4915 |
| Leather V   | 5175 |
| Leather VI  | 5435 |

**Upholstery Requires:**

Fabric: 3¼ Yards  
Leather: 58½ Sq. Ft.

**Pricing for Multiple Fabric Placement:**

*(To Calculate, Begin with Base Price and add Upcharges)*

**Back Upholstery:**

|             |      |
|-------------|------|
| COM/COL     | 55   |
| Grade A     | 20   |
| Grade B     | 35   |
| Grade C     | 55   |
| Grade D     | 75   |
| Grade E     | 95   |
| Grade F     | 120  |
| Grade G     | 145  |
| Grade H     | 175  |
| Grade J     | 195  |
| Grade K     | 230  |
| Grade L     | 290  |
| Grade M     | 370  |
| Leather I   | 500  |
| Leather II  | 640  |
| Leather III | 780  |
| Leather IV  | 920  |
| Leather V   | 1060 |
| Leather VI  | 1200 |

**Upholstery Requires (Per Application):**

Fabric: 1¾ Yards  
Leather: 31½ Sq. Ft.

**Seat Upholstery:**

|             |      |
|-------------|------|
| COM/COL     | 50   |
| Grade A     | 15   |
| Grade B     | 35   |
| Grade C     | 50   |
| Grade D     | 65   |
| Grade E     | 85   |
| Grade F     | 105  |
| Grade G     | 125  |
| Grade H     | 150  |
| Grade J     | 165  |
| Grade K     | 200  |
| Grade L     | 250  |
| Grade M     | 315  |
| Leather I   | 430  |
| Leather II  | 550  |
| Leather III | 670  |
| Leather IV  | 790  |
| Leather V   | 910  |
| Leather VI  | 1030 |

**Upholstery Requires (Per Application):**

Fabric: 1½ Yards  
Leather: 27 Sq. Ft.

Base Price: 3205

**Total Required**

**Upholstery:** Fabric: 3¼ Yards  
Leather: 58½ Sq. Ft.

PLEASE SPECIFY THE FOLLOWING TO ORDER:

|                            |  |  |  |   |
|----------------------------|--|--|--|---|
| <p><b>MODEL NUMBER</b></p> | <p><b>TEXTILES</b></p> <p>Indicate fabric choice for:</p> <p>Back upholstery</p> <p><i>See options for fabrics at <a href="http://www.bbftextiles.com">www.bbftextiles.com</a></i></p> | <p><b>TEXTILES</b></p> <p>Indicate fabric choice for:</p> <p>Seat upholstery</p> <p><i>See options for fabrics at <a href="http://www.bbftextiles.com">www.bbftextiles.com</a></i></p> | <p><b>FLAMMABILITY</b></p> <p>Indicate flammability:</p> <p><b>U</b> = Cal 117</p> | <p><b>CASTER</b></p> <p><b>DWCM</b> = Double Wheel - Medium Casters</p> <p><b>DWCS</b> = Double Wheel - Soft Casters +\$106</p> |
|----------------------------|--|--|--|---|

HST222-181.BackFabric.SeatFabric.Flammability.Caster Example: HST222-181.950-88.950-88.U.DWCM



**Dimensions**

**Cadre HST222-611**



|    |         |     |         |
|----|---------|-----|---------|
| OH | 35½-39½ | AH  | 26½-30½ |
| OW | 24      | WBA | 19      |
| OD | 26      | DED |         |
| SH | 18½-22½ | DEW |         |
| SD | 19      | R   |         |

|                 |      |
|-----------------|------|
| Shipping Weight | 66   |
| Cube            | 20.4 |

Mid Back | Upholstered Back and Seat | Polished Aluminum Arm with Urethane Arm Cap | Five-Prong Polished Aluminum Base |

Synchronized Adjustments | Double Wheel Casters

ANSI/BIFMA LEVEL® Furniture Sustainability Standard certified  
Indoor Advantage™ certified

**Pricing for Single Fabric Placement:**

**Upholstery:**

|             |      |
|-------------|------|
| COM/COL     | 2485 |
| Grade A     | 2445 |
| Grade B     | 2465 |
| Grade C     | 2485 |
| Grade D     | 2515 |
| Grade E     | 2535 |
| Grade F     | 2555 |
| Grade G     | 2595 |
| Grade H     | 2625 |
| Grade J     | 2645 |
| Grade K     | 2685 |
| Grade L     | 2755 |
| Grade M     | 2845 |
| Leather I   | 2995 |
| Leather II  | 3155 |
| Leather III | 3315 |
| Leather IV  | 3475 |
| Leather V   | 3635 |
| Leather VI  | 3795 |

**Upholstery Requires:**

|             |         |
|-------------|---------|
| Fabric: 2   | Yards   |
| Leather: 36 | Sq. Ft. |

**Pricing for Multiple Fabric Placement:**

*(To Calculate, Begin with Base Price and add Upcharges)*

**Back Upholstery:**

|             |     |
|-------------|-----|
| COM/COL     | 30  |
| Grade A     | 10  |
| Grade B     | 20  |
| Grade C     | 30  |
| Grade D     | 45  |
| Grade E     | 55  |
| Grade F     | 65  |
| Grade G     | 85  |
| Grade H     | 100 |
| Grade J     | 110 |
| Grade K     | 130 |
| Grade L     | 165 |
| Grade M     | 210 |
| Leather I   | 285 |
| Leather II  | 365 |
| Leather III | 445 |
| Leather IV  | 525 |
| Leather V   | 605 |
| Leather VI  | 685 |

**Upholstery Requires (Per Application):**

|             |         |
|-------------|---------|
| Fabric: 1   | Yard    |
| Leather: 18 | Sq. Ft. |

**Seat Upholstery:**

|             |     |
|-------------|-----|
| COM/COL     | 30  |
| Grade A     | 10  |
| Grade B     | 20  |
| Grade C     | 30  |
| Grade D     | 45  |
| Grade E     | 55  |
| Grade F     | 65  |
| Grade G     | 85  |
| Grade H     | 100 |
| Grade J     | 110 |
| Grade K     | 130 |
| Grade L     | 165 |
| Grade M     | 210 |
| Leather I   | 285 |
| Leather II  | 365 |
| Leather III | 445 |
| Leather IV  | 525 |
| Leather V   | 605 |
| Leather VI  | 685 |

**Upholstery Requires (Per Application):**

|             |         |
|-------------|---------|
| Fabric: 1   | Yard    |
| Leather: 18 | Sq. Ft. |

**Base Price:** 2420

**Total Required**

**Upholstery:** Fabric: 2 Yards  
Leather: 36 Sq. Ft.

PLEASE SPECIFY THE FOLLOWING TO ORDER:

|                            |  |  |  |   |
|----------------------------|--|--|--|---|
| <p><b>MODEL NUMBER</b></p> | <p><b>TEXTILES</b></p> <p>Indicate fabric choice for:</p> <p>Back upholstery</p> <p><i>See options for fabrics at <a href="http://www.bbftextiles.com">www.bbftextiles.com</a></i></p> | <p><b>TEXTILES</b></p> <p>Indicate fabric choice for:</p> <p>Seat upholstery</p> <p><i>See options for fabrics at <a href="http://www.bbftextiles.com">www.bbftextiles.com</a></i></p> | <p><b>FLAMMABILITY</b></p> <p>Indicate flammability:</p> <p><b>U</b> = Cal 117</p> | <p><b>CASTER</b></p> <p><b>DWCM</b> = Double Wheel - Medium Casters</p> <p><b>DWCS</b> = Double Wheel - Soft Casters +\$106</p> |
|----------------------------|--|--|--|---|

HST222-611.BackFabric.SeatFabric.Flammability.Caster Example: HST222-611.950-88.950-88.U.DWCM



Dimensions

Cadre HST222-621



|    |         |     |         |
|----|---------|-----|---------|
| OH | 41½-44½ | AH  | 26½-30½ |
| OW | 24      | WBA | 19      |
| OD | 26      | DED |         |
| SH | 18½-22½ | DEW |         |
| SD | 19      | R   |         |

|                 |      |
|-----------------|------|
| Shipping Weight | 66   |
| Cube            | 22.5 |

High Back | Upholstered Back and Seat | Polished Aluminum Arm with Urethane Arm Cap | Five-Prong Polished Aluminum Base |

Synchronized Adjustments | Double Wheel Casters

ANSI/BIFMA LEVEL® Furniture Sustainability Standard certified  
Indoor Advantage™ certified

**Pricing for Single Fabric Placement:**

**Upholstery:**

|             |      |
|-------------|------|
| COM/COL     | 2830 |
| Grade A     | 2780 |
| Grade B     | 2805 |
| Grade C     | 2830 |
| Grade D     | 2855 |
| Grade E     | 2880 |
| Grade F     | 2910 |
| Grade G     | 2945 |
| Grade H     | 2980 |
| Grade J     | 3005 |
| Grade K     | 3055 |
| Grade L     | 3130 |
| Grade M     | 3230 |
| Leather I   | 3400 |
| Leather II  | 3580 |
| Leather III | 3760 |
| Leather IV  | 3940 |
| Leather V   | 4120 |
| Leather VI  | 4300 |

**Upholstery Requires:**

Fabric: 2¼ Yards  
Leather: 40½ Sq. Ft.

**Pricing for Multiple Fabric Placement:**

*(To Calculate, Begin with Base Price and add Upcharges)*

**Back Upholstery:**

|             |     |
|-------------|-----|
| COM/COL     | 45  |
| Grade A     | 15  |
| Grade B     | 30  |
| Grade C     | 45  |
| Grade D     | 55  |
| Grade E     | 70  |
| Grade F     | 90  |
| Grade G     | 105 |
| Grade H     | 125 |
| Grade J     | 140 |
| Grade K     | 170 |
| Grade L     | 210 |
| Grade M     | 265 |
| Leather I   | 360 |
| Leather II  | 460 |
| Leather III | 560 |
| Leather IV  | 660 |
| Leather V   | 760 |
| Leather VI  | 860 |

**Upholstery Requires (Per Application):**

Fabric: 1¼ Yards  
Leather: 22½ Sq. Ft.

**Seat Upholstery:**

|             |     |
|-------------|-----|
| COM/COL     | 30  |
| Grade A     | 10  |
| Grade B     | 20  |
| Grade C     | 30  |
| Grade D     | 45  |
| Grade E     | 55  |
| Grade F     | 65  |
| Grade G     | 85  |
| Grade H     | 100 |
| Grade J     | 110 |
| Grade K     | 130 |
| Grade L     | 165 |
| Grade M     | 210 |
| Leather I   | 285 |
| Leather II  | 365 |
| Leather III | 445 |
| Leather IV  | 525 |
| Leather V   | 605 |
| Leather VI  | 685 |

**Upholstery Requires (Per Application):**

Fabric: 1 Yard  
Leather: 18 Sq. Ft.

Base Price: 2755

**Total Required**

**Upholstery:** Fabric: 2¼ Yards  
Leather: 40½ Sq. Ft.

PLEASE SPECIFY THE FOLLOWING TO ORDER:

|                            |  |  |  |   |
|----------------------------|--|--|--|---|
| <p><b>MODEL NUMBER</b></p> | <p><b>TEXTILES</b></p> <p>Indicate fabric choice for:</p> <p>Back upholstery</p> <p><i>See options for fabrics at <a href="http://www.bbftextiles.com">www.bbftextiles.com</a></i></p> | <p><b>TEXTILES</b></p> <p>Indicate fabric choice for:</p> <p>Seat upholstery</p> <p><i>See options for fabrics at <a href="http://www.bbftextiles.com">www.bbftextiles.com</a></i></p> | <p><b>FLAMMABILITY</b></p> <p>Indicate flammability:</p> <p><b>U</b> = Cal 117</p> | <p><b>CASTER</b></p> <p><b>DWCM</b> = Double Wheel - Medium Casters</p> <p><b>DWCS</b> = Double Wheel - Soft Casters +\$106</p> |
|----------------------------|--|--|--|---|

HST222-621.BackFabric.SeatFabric.Flammability.Caster Example: HST222-621.950-88.950-88.U.DWCM



Dimensions

Cadre HST222-631



|    |         |     |         |
|----|---------|-----|---------|
| OH | 35½-39½ | AH  | 26½-30½ |
| OW | 24      | WBA | 19      |
| OD | 26      | DED |         |
| SH | 18½-22½ | DEW |         |
| SD | 19      | R   |         |

Shipping Weight 66  
Cube 20.4

Mid Back | Upholstered Back and Seat | Full Polished Aluminum Wrap Around Arm with Urethane Arm Cap |

ANSI/BIFMA LEVEL® Furniture Sustainability Standard certified  
Indoor Advantage™ certified

Knee Tilt | Five-Prong Polished Aluminum Base | Double Wheel Casters

**Pricing for Single Fabric Placement:**

**Upholstery:**

|             |      |
|-------------|------|
| COM/COL     | 2500 |
| Grade A     | 2460 |
| Grade B     | 2480 |
| Grade C     | 2500 |
| Grade D     | 2530 |
| Grade E     | 2550 |
| Grade F     | 2570 |
| Grade G     | 2610 |
| Grade H     | 2640 |
| Grade J     | 2660 |
| Grade K     | 2700 |
| Grade L     | 2770 |
| Grade M     | 2860 |
| Leather I   | 3010 |
| Leather II  | 3170 |
| Leather III | 3330 |
| Leather IV  | 3490 |
| Leather V   | 3650 |
| Leather VI  | 3810 |

**Upholstery Requires:**

Fabric: 2 Yards  
Leather: 36 Sq. Ft.

**Pricing for Multiple Fabric Placement:**

*(To Calculate, Begin with Base Price and add Upcharges)*

**Back Upholstery:**

|             |     |
|-------------|-----|
| COM/COL     | 30  |
| Grade A     | 10  |
| Grade B     | 20  |
| Grade C     | 30  |
| Grade D     | 45  |
| Grade E     | 55  |
| Grade F     | 65  |
| Grade G     | 85  |
| Grade H     | 100 |
| Grade J     | 110 |
| Grade K     | 130 |
| Grade L     | 165 |
| Grade M     | 210 |
| Leather I   | 285 |
| Leather II  | 365 |
| Leather III | 445 |
| Leather IV  | 525 |
| Leather V   | 605 |
| Leather VI  | 685 |

**Upholstery Requires (Per Application):**

Fabric: 1 Yard  
Leather: 18 Sq. Ft.

**Seat Upholstery:**

|             |     |
|-------------|-----|
| COM/COL     | 30  |
| Grade A     | 10  |
| Grade B     | 20  |
| Grade C     | 30  |
| Grade D     | 45  |
| Grade E     | 55  |
| Grade F     | 65  |
| Grade G     | 85  |
| Grade H     | 100 |
| Grade J     | 110 |
| Grade K     | 130 |
| Grade L     | 165 |
| Grade M     | 210 |
| Leather I   | 285 |
| Leather II  | 365 |
| Leather III | 445 |
| Leather IV  | 525 |
| Leather V   | 605 |
| Leather VI  | 685 |

**Upholstery Requires (Per Application):**

Fabric: 1 Yard  
Leather: 18 Sq. Ft.

Base Price: 2435

**Total Required**

**Upholstery:** Fabric: 2 Yards  
Leather: 36 Sq. Ft.

PLEASE SPECIFY THE FOLLOWING TO ORDER:

|                            |  |  |  |   |
|----------------------------|--|--|--|---|
| <p><b>MODEL NUMBER</b></p> | <p><b>TEXTILES</b></p> <p>Indicate fabric choice for:</p> <p>Back upholstery</p> <p><i>See options for fabrics at <a href="http://www.bbftextiles.com">www.bbftextiles.com</a></i></p> | <p><b>TEXTILES</b></p> <p>Indicate fabric choice for:</p> <p>Seat upholstery</p> <p><i>See options for fabrics at <a href="http://www.bbftextiles.com">www.bbftextiles.com</a></i></p> | <p><b>FLAMMABILITY</b></p> <p>Indicate flammability:</p> <p><b>U</b> = Cal 117</p> | <p><b>CASTER</b></p> <p><b>DWCM</b> = Double Wheel - Medium Casters</p> <p><b>DWCS</b> = Double Wheel - Soft Casters +\$106</p> |
|----------------------------|--|--|--|---|

HST222-631.BackFabric.SeatFabric.Flammability.Caster Example: HST222-631.950-88.950-88.U.DWCM



Dimensions

Cadre HST222-641



|    |         |     |         |
|----|---------|-----|---------|
| OH | 41½-44½ | AH  | 26½-30½ |
| OW | 24      | WBA | 19      |
| OD | 26      | DED |         |
| SH | 18½-22½ | DEW |         |
| SD | 19      | R   |         |

Shipping Weight 66  
Cube 22.5

High Back | Upholstered Back and Seat | Full Polished Aluminum Wrap Around Arm with Urethane Arm Cap |

ANSI/BIFMA LEVEL® Furniture Sustainability Standard certified  
Indoor Advantage™ certified

Knee Tilt | Five-Prong Polished Aluminum Base | Double Wheel Casters

**Pricing for Single Fabric Placement:**

**Upholstery:**

|             |      |
|-------------|------|
| COM/COL     | 2850 |
| Grade A     | 2800 |
| Grade B     | 2825 |
| Grade C     | 2850 |
| Grade D     | 2875 |
| Grade E     | 2900 |
| Grade F     | 2930 |
| Grade G     | 2965 |
| Grade H     | 3000 |
| Grade J     | 3025 |
| Grade K     | 3075 |
| Grade L     | 3150 |
| Grade M     | 3250 |
| Leather I   | 3420 |
| Leather II  | 3600 |
| Leather III | 3780 |
| Leather IV  | 3960 |
| Leather V   | 4140 |
| Leather VI  | 4320 |

**Upholstery Requires:**

Fabric: 2¼ Yards  
Leather: 40½ Sq. Ft.

**Pricing for Multiple Fabric Placement:**

*(To Calculate, Begin with Base Price and add Upcharges)*

**Back Upholstery:**

|             |     |
|-------------|-----|
| COM/COL     | 45  |
| Grade A     | 15  |
| Grade B     | 30  |
| Grade C     | 45  |
| Grade D     | 55  |
| Grade E     | 70  |
| Grade F     | 90  |
| Grade G     | 105 |
| Grade H     | 125 |
| Grade J     | 140 |
| Grade K     | 170 |
| Grade L     | 210 |
| Grade M     | 265 |
| Leather I   | 360 |
| Leather II  | 460 |
| Leather III | 560 |
| Leather IV  | 660 |
| Leather V   | 760 |
| Leather VI  | 860 |

**Upholstery Requires (Per Application):**

Fabric: 1¼ Yards  
Leather: 22½ Sq. Ft.

**Seat Upholstery:**

|             |     |
|-------------|-----|
| COM/COL     | 30  |
| Grade A     | 10  |
| Grade B     | 20  |
| Grade C     | 30  |
| Grade D     | 45  |
| Grade E     | 55  |
| Grade F     | 65  |
| Grade G     | 85  |
| Grade H     | 100 |
| Grade J     | 110 |
| Grade K     | 130 |
| Grade L     | 165 |
| Grade M     | 210 |
| Leather I   | 285 |
| Leather II  | 365 |
| Leather III | 445 |
| Leather IV  | 525 |
| Leather V   | 605 |
| Leather VI  | 685 |

**Upholstery Requires (Per Application):**

Fabric: 1 Yard  
Leather: 18 Sq. Ft.

Base Price: 2775

**Total Required**

**Upholstery:** Fabric: 2¼ Yards  
Leather: 40½ Sq. Ft.

PLEASE SPECIFY THE FOLLOWING TO ORDER:

|                            |  |  |  |   |
|----------------------------|--|--|--|---|
| <p><b>MODEL NUMBER</b></p> | <p><b>TEXTILES</b></p> <p>Indicate fabric choice for:</p> <p>Back upholstery</p> <p><i>See options for fabrics at <a href="http://www.bbftextiles.com">www.bbftextiles.com</a></i></p> | <p><b>TEXTILES</b></p> <p>Indicate fabric choice for:</p> <p>Seat upholstery</p> <p><i>See options for fabrics at <a href="http://www.bbftextiles.com">www.bbftextiles.com</a></i></p> | <p><b>FLAMMABILITY</b></p> <p>Indicate flammability:</p> <p><b>U</b> = Cal 117</p> | <p><b>CASTER</b></p> <p><b>DWCM</b> = Double Wheel - Medium Casters</p> <p><b>DWCS</b> = Double Wheel - Soft Casters +\$106</p> |
|----------------------------|--|--|--|---|

HST222-641.BackFabric.SeatFabric.Flammability.Caster Example: HST222-641.950-88.950-88.U.DWCM





**Dimensions**

**Cadre HST222-651**



|                 |         |      |         |
|-----------------|---------|------|---------|
| OH              | 35½-39½ | AH   | 26½-30½ |
| OW              | 24      | WBA  | 19      |
| OD              | 26      | DED  |         |
| SH              | 18½-22½ | DEW  |         |
| SD              | 19      | R    |         |
| Shipping Weight |         | 66   |         |
| Cube            |         | 20.4 |         |

Mid Back | Channel Stitched Upholstered Back and Seat | Polished Aluminum Arm with Urethane Arm Cap |

ANSI/BIFMA LEVEL® Furniture Sustainability Standard certified  
Indoor Advantage™ certified

Synchronized Adjustments | Five-Prong Polished Aluminum Base | Double Wheel Casters

**Pricing for Single Fabric Placement:**

**Upholstery:**

|             |      |
|-------------|------|
| COM/COL     | 2995 |
| Grade A     | 2910 |
| Grade B     | 2955 |
| Grade C     | 2995 |
| Grade D     | 3035 |
| Grade E     | 3080 |
| Grade F     | 3130 |
| Grade G     | 3185 |
| Grade H     | 3245 |
| Grade J     | 3285 |
| Grade K     | 3370 |
| Grade L     | 3495 |
| Grade M     | 3660 |
| Leather I   | 3945 |
| Leather II  | 4245 |
| Leather III | 4545 |
| Leather IV  | 4845 |
| Leather V   | 5145 |
| Leather VI  | 5445 |

**Upholstery Requires:**

Fabric: 3¾ Yards  
Leather: 67½ Sq. Ft.

**Pricing for Multiple Fabric Placement:**

*(To Calculate, Begin with Base Price and add Upcharges)*

**Back Upholstery:**

|             |      |
|-------------|------|
| COM/COL     | 75   |
| Grade A     | 25   |
| Grade B     | 50   |
| Grade C     | 75   |
| Grade D     | 100  |
| Grade E     | 125  |
| Grade F     | 155  |
| Grade G     | 190  |
| Grade H     | 225  |
| Grade J     | 250  |
| Grade K     | 300  |
| Grade L     | 375  |
| Grade M     | 475  |
| Leather I   | 645  |
| Leather II  | 825  |
| Leather III | 1005 |
| Leather IV  | 1185 |
| Leather V   | 1365 |
| Leather VI  | 1545 |

**Upholstery Requires (Per Application):**

Fabric: 2¼ Yards  
Leather: 40½ Sq. Ft.

**Seat Upholstery:**

|             |      |
|-------------|------|
| COM/COL     | 50   |
| Grade A     | 15   |
| Grade B     | 35   |
| Grade C     | 50   |
| Grade D     | 65   |
| Grade E     | 85   |
| Grade F     | 105  |
| Grade G     | 125  |
| Grade H     | 150  |
| Grade J     | 165  |
| Grade K     | 200  |
| Grade L     | 250  |
| Grade M     | 315  |
| Leather I   | 430  |
| Leather II  | 550  |
| Leather III | 670  |
| Leather IV  | 790  |
| Leather V   | 910  |
| Leather VI  | 1030 |

**Upholstery Requires (Per Application):**

Fabric: 1½ Yards  
Leather: 27 Sq. Ft.

Base Price: 2870

**Total Required**

**Upholstery:** Fabric: 3¾ Yards  
Leather: 67½ Sq. Ft.

PLEASE SPECIFY THE FOLLOWING TO ORDER:

|                            |  |  |  |   |
|----------------------------|--|--|--|---|
| <p><b>MODEL NUMBER</b></p> | <p><b>TEXTILES</b></p> <p>Indicate fabric choice for:</p> <p>Back upholstery</p> <p><i>See options for fabrics at <a href="http://www.bbftextiles.com">www.bbftextiles.com</a></i></p> | <p><b>TEXTILES</b></p> <p>Indicate fabric choice for:</p> <p>Seat upholstery</p> <p><i>See options for fabrics at <a href="http://www.bbftextiles.com">www.bbftextiles.com</a></i></p> | <p><b>FLAMMABILITY</b></p> <p>Indicate flammability:</p> <p><b>U</b> = Cal 117</p> | <p><b>CASTER</b></p> <p><b>DWCM</b> = Double Wheel - Medium Casters</p> <p><b>DWCS</b> = Double Wheel - Soft Casters +\$106</p> |
|----------------------------|--|--|--|---|

HST222-651.BackFabric.SeatFabric.Flammability.Caster Example: HST222-651.950-88.950-88.U.DWCM



**Dimensions**

**Cadre HST222-661**



|    |         |     |         |
|----|---------|-----|---------|
| OH | 41½-44½ | AH  | 26½-30½ |
| OW | 24      | WBA | 19      |
| OD | 26      | DED |         |
| SH | 18½-22½ | DEW |         |
| SD | 19      | R   |         |

Shipping Weight 66  
Cube 22.5

High Back | Channel Stitched Upholstered Back and Seat | Polished Aluminum Arm with Urethane Arm Cap |

ANSI/BIFMA LEVEL® Furniture Sustainability Standard certified  
Indoor Advantage™ certified

Synchronized Adjustments | Five-Prong Polished Aluminum Base | Double Wheel Casters

**Pricing for Single Fabric Placement:**

**Upholstery:**

|             |      |
|-------------|------|
| COM/COL     | 3285 |
| Grade A     | 3215 |
| Grade B     | 3250 |
| Grade C     | 3285 |
| Grade D     | 3325 |
| Grade E     | 3360 |
| Grade F     | 3400 |
| Grade G     | 3455 |
| Grade H     | 3505 |
| Grade J     | 3540 |
| Grade K     | 3610 |
| Grade L     | 3720 |
| Grade M     | 3865 |
| Leather I   | 4110 |
| Leather II  | 4370 |
| Leather III | 4630 |
| Leather IV  | 4890 |
| Leather V   | 5150 |
| Leather VI  | 5410 |

**Upholstery Requires:**

Fabric: 3¼ Yards  
Leather: 58½ Sq. Ft.

**Pricing for Multiple Fabric Placement:**

*(To Calculate, Begin with Base Price and add Upcharges)*

**Back Upholstery:**

|             |      |
|-------------|------|
| COM/COL     | 55   |
| Grade A     | 20   |
| Grade B     | 35   |
| Grade C     | 55   |
| Grade D     | 75   |
| Grade E     | 95   |
| Grade F     | 120  |
| Grade G     | 145  |
| Grade H     | 175  |
| Grade J     | 195  |
| Grade K     | 230  |
| Grade L     | 290  |
| Grade M     | 370  |
| Leather I   | 500  |
| Leather II  | 640  |
| Leather III | 780  |
| Leather IV  | 920  |
| Leather V   | 1060 |
| Leather VI  | 1200 |

**Upholstery Requires (Per Application):**

Fabric: 1¾ Yards  
Leather: 31½ Sq. Ft.

**Seat Upholstery:**

|             |      |
|-------------|------|
| COM/COL     | 50   |
| Grade A     | 15   |
| Grade B     | 35   |
| Grade C     | 50   |
| Grade D     | 65   |
| Grade E     | 85   |
| Grade F     | 105  |
| Grade G     | 125  |
| Grade H     | 150  |
| Grade J     | 165  |
| Grade K     | 200  |
| Grade L     | 250  |
| Grade M     | 315  |
| Leather I   | 430  |
| Leather II  | 550  |
| Leather III | 670  |
| Leather IV  | 790  |
| Leather V   | 910  |
| Leather VI  | 1030 |

**Upholstery Requires (Per Application):**

Fabric: 1½ Yards  
Leather: 27 Sq. Ft.

Base Price: 3180

**Total Required**

**Upholstery:** Fabric: 3¼ Yards  
Leather: 58½ Sq. Ft.

PLEASE SPECIFY THE FOLLOWING TO ORDER:

|                            |  |  |  |   |
|----------------------------|--|--|--|---|
| <p><b>MODEL NUMBER</b></p> | <p><b>TEXTILES</b></p> <p>Indicate fabric choice for:</p> <p>Back upholstery</p> <p><i>See options for fabrics at <a href="http://www.bbftextiles.com">www.bbftextiles.com</a></i></p> | <p><b>TEXTILES</b></p> <p>Indicate fabric choice for:</p> <p>Seat upholstery</p> <p><i>See options for fabrics at <a href="http://www.bbftextiles.com">www.bbftextiles.com</a></i></p> | <p><b>FLAMMABILITY</b></p> <p>Indicate flammability:</p> <p><b>U</b> = Cal 117</p> | <p><b>CASTER</b></p> <p><b>DWCM</b> = Double Wheel - Medium Casters</p> <p><b>DWCS</b> = Double Wheel - Soft Casters +\$106</p> |
|----------------------------|--|--|--|---|

HST222-661.BackFabric.SeatFabric.Flammability.Caster Example: HST222-661.950-88.950-88.U.DWCM



**Dimensions**

**Cadre HST222-671**



|    |         |     |         |
|----|---------|-----|---------|
| OH | 35½-39½ | AH  | 26½-30½ |
| OW | 24      | WBA | 19      |
| OD | 26      | DED |         |
| SH | 18½-22½ | DEW |         |
| SD | 19      | R   |         |

Shipping Weight 66  
Cube 20.4

Mid Back | Channel Stitched Upholstered Back and Seat | Full Polished Aluminum Wrap Around Arm with Urethane Arm Cap |

Knee Tilt | Five-Prong Polished Aluminum Base | Double Wheel Casters

ANSI/BIFMA LEVEL® Furniture Sustainability Standard certified  
Indoor Advantage™ certified

**Pricing for Single Fabric Placement:**

**Upholstery:**

|             |      |
|-------------|------|
| COM/COL     | 3015 |
| Grade A     | 2930 |
| Grade B     | 2975 |
| Grade C     | 3015 |
| Grade D     | 3055 |
| Grade E     | 3100 |
| Grade F     | 3150 |
| Grade G     | 3205 |
| Grade H     | 3265 |
| Grade J     | 3305 |
| Grade K     | 3390 |
| Grade L     | 3515 |
| Grade M     | 3680 |
| Leather I   | 3965 |
| Leather II  | 4265 |
| Leather III | 4565 |
| Leather IV  | 4865 |
| Leather V   | 5165 |
| Leather VI  | 5465 |

**Upholstery Requires:**

Fabric: 3¾ Yards  
Leather: 67½ Sq. Ft.

**Pricing for Multiple Fabric Placement:**

*(To Calculate, Begin with Base Price and add Upcharges)*

**Back Upholstery:**

|             |      |
|-------------|------|
| COM/COL     | 75   |
| Grade A     | 25   |
| Grade B     | 50   |
| Grade C     | 75   |
| Grade D     | 100  |
| Grade E     | 125  |
| Grade F     | 155  |
| Grade G     | 190  |
| Grade H     | 225  |
| Grade J     | 250  |
| Grade K     | 300  |
| Grade L     | 375  |
| Grade M     | 475  |
| Leather I   | 645  |
| Leather II  | 825  |
| Leather III | 1005 |
| Leather IV  | 1185 |
| Leather V   | 1365 |
| Leather VI  | 1545 |

**Upholstery Requires (Per Application):**

Fabric: 2¼ Yards  
Leather: 40½ Sq. Ft.

**Seat Upholstery:**

|             |      |
|-------------|------|
| COM/COL     | 50   |
| Grade A     | 15   |
| Grade B     | 35   |
| Grade C     | 50   |
| Grade D     | 65   |
| Grade E     | 85   |
| Grade F     | 105  |
| Grade G     | 125  |
| Grade H     | 150  |
| Grade J     | 165  |
| Grade K     | 200  |
| Grade L     | 250  |
| Grade M     | 315  |
| Leather I   | 430  |
| Leather II  | 550  |
| Leather III | 670  |
| Leather IV  | 790  |
| Leather V   | 910  |
| Leather VI  | 1030 |

**Upholstery Requires (Per Application):**

Fabric: 1½ Yards  
Leather: 27 Sq. Ft.

Base Price: 2890

**Total Required**

**Upholstery:** Fabric: 3¾ Yards  
Leather: 67½ Sq. Ft.

PLEASE SPECIFY THE FOLLOWING TO ORDER:

|                            |  |  |  |   |
|----------------------------|--|--|--|---|
| <p><b>MODEL NUMBER</b></p> | <p><b>TEXTILES</b></p> <p>Indicate fabric choice for:</p> <p>Back upholstery</p> <p><i>See options for fabrics at <a href="http://www.bbftextiles.com">www.bbftextiles.com</a></i></p> | <p><b>TEXTILES</b></p> <p>Indicate fabric choice for:</p> <p>Seat upholstery</p> <p><i>See options for fabrics at <a href="http://www.bbftextiles.com">www.bbftextiles.com</a></i></p> | <p><b>FLAMMABILITY</b></p> <p>Indicate flammability:</p> <p><b>U</b> = Cal 117</p> | <p><b>CASTER</b></p> <p><b>DWCM</b> = Double Wheel - Medium Casters</p> <p><b>DWCS</b> = Double Wheel - Soft Casters +\$106</p> |
|----------------------------|--|--|--|---|

HST222-671.BackFabric.SeatFabric.Flammability.Caster Example: HST222-671.950-88.950-88.U.DWCM



Dimensions

Cadre HST222-681



|    |         |     |         |
|----|---------|-----|---------|
| OH | 41½-44½ | AH  | 26½-30½ |
| OW | 24      | WBA | 19      |
| OD | 26      | DED |         |
| SH | 18½-22½ | DEW |         |
| SD | 19      | R   |         |

Shipping Weight 66  
Cube 22.5

High Back | Channel Stitched Upholstered Back and Seat | Full Polished Aluminum Wrap Around Arm with Urethane Cap |

Knee Tilt | Five-Prong Polished Aluminum Base | Double Wheel Casters

ANSI/BIFMA LEVEL® Furniture Sustainability Standard certified  
Indoor Advantage™ certified

**Pricing for Single Fabric Placement:**

**Upholstery:**

|             |      |
|-------------|------|
| COM/COL     | 3310 |
| Grade A     | 3240 |
| Grade B     | 3275 |
| Grade C     | 3310 |
| Grade D     | 3350 |
| Grade E     | 3385 |
| Grade F     | 3425 |
| Grade G     | 3480 |
| Grade H     | 3530 |
| Grade J     | 3565 |
| Grade K     | 3635 |
| Grade L     | 3745 |
| Grade M     | 3890 |
| Leather I   | 4135 |
| Leather II  | 4395 |
| Leather III | 4655 |
| Leather IV  | 4915 |
| Leather V   | 5175 |
| Leather VI  | 5435 |

**Upholstery Requires:**

Fabric: 3¼ Yards  
Leather: 58½ Sq. Ft.

**Pricing for Multiple Fabric Placement:**

*(To Calculate, Begin with Base Price and add Upcharges)*

**Back Upholstery:**

|             |      |
|-------------|------|
| COM/COL     | 55   |
| Grade A     | 20   |
| Grade B     | 35   |
| Grade C     | 55   |
| Grade D     | 75   |
| Grade E     | 95   |
| Grade F     | 120  |
| Grade G     | 145  |
| Grade H     | 175  |
| Grade J     | 195  |
| Grade K     | 230  |
| Grade L     | 290  |
| Grade M     | 370  |
| Leather I   | 500  |
| Leather II  | 640  |
| Leather III | 780  |
| Leather IV  | 920  |
| Leather V   | 1060 |
| Leather VI  | 1200 |

**Upholstery Requires (Per Application):**

Fabric: 1¾ Yards  
Leather: 31½ Sq. Ft.

**Seat Upholstery:**

|             |      |
|-------------|------|
| COM/COL     | 50   |
| Grade A     | 15   |
| Grade B     | 35   |
| Grade C     | 50   |
| Grade D     | 65   |
| Grade E     | 85   |
| Grade F     | 105  |
| Grade G     | 125  |
| Grade H     | 150  |
| Grade J     | 165  |
| Grade K     | 200  |
| Grade L     | 250  |
| Grade M     | 315  |
| Leather I   | 430  |
| Leather II  | 550  |
| Leather III | 670  |
| Leather IV  | 790  |
| Leather V   | 910  |
| Leather VI  | 1030 |

**Upholstery Requires (Per Application):**

Fabric: 1½ Yards  
Leather: 27 Sq. Ft.

Base Price: 3205

**Total Required**

**Upholstery:** Fabric: 3¼ Yards  
Leather: 58½ Sq. Ft.

PLEASE SPECIFY THE FOLLOWING TO ORDER:

|                            |  |  |  |   |
|----------------------------|--|--|--|---|
| <p><b>MODEL NUMBER</b></p> | <p><b>TEXTILES</b></p> <p>Indicate fabric choice for:</p> <p>Back upholstery</p> <p><i>See options for fabrics at <a href="http://www.bbftextiles.com">www.bbftextiles.com</a></i></p> | <p><b>TEXTILES</b></p> <p>Indicate fabric choice for:</p> <p>Seat upholstery</p> <p><i>See options for fabrics at <a href="http://www.bbftextiles.com">www.bbftextiles.com</a></i></p> | <p><b>FLAMMABILITY</b></p> <p>Indicate flammability:</p> <p><b>U</b> = Cal 117</p> | <p><b>CASTER</b></p> <p><b>DWCM</b> = Double Wheel - Medium Casters</p> <p><b>DWCS</b> = Double Wheel - Soft Casters +\$106</p> |
|----------------------------|--|--|--|---|

HST222-681.BackFabric.SeatFabric.Flammability.Caster Example: HST222-681.950-88.950-88.U.DWCM