

# RENAULT SYMBIOZ E-TECH FULL HYBRID

145 HP



9th July 2024





# technology that reconnects you

The ultimate lifestyle car, Renault Symbioz combines all the advantages of a compact vehicle with those of a family car. The interior is both technologically advanced and comfortable to ensure your well-being, with generous interior space, solarbay<sup>®</sup> opacifying panoramic sunroof<sup>(1)</sup>, premium Harman Kardon<sup>®</sup> sound<sup>(1)</sup> and the openR link multimedia system.



## When technology meets interior comfort for an enhanced on-board experience.

**solarbay<sup>®</sup>  
opacifying  
panoramic  
sunroof<sup>(1)</sup>**

**openR link  
system with  
Google built-in<sup>(2)</sup>**

**24 advanced  
driver-  
assistance  
systems**

**Up to 624 litres<sup>(3)</sup>  
of boot volume<sup>(4)</sup>**

**E-Tech full  
hybrid 145 hp  
engine**

**up to 630 miles  
of driving  
range<sup>(5)</sup>**

(1) only available on iconic esprit Alpine. (2) Google, Google Maps, Google News, Waze and other marks are trademarks of Google LLC. (3) with bench seat forwards. (4) the equivalent volume measured according to VDA standard (ISO 3832) is 548 dm<sup>3</sup> for the E-Tech full hybrid version (the VDA standard involves measuring the total volume of the boot using standardised objects (200 mm x 100 mm x 50 mm = 1 dm<sup>3</sup>)). (5) internal source, based on new Symbioz E-Tech iconic esprit Alpine vs WLTP fuel consumption figures. Figures shown are for comparability purposes only. Actual real world driving results may vary depending on factors including the starting charge of the battery, accessories fitted after registration, weather conditions, driving styles and vehicle load.

# **interactive menu**

**01. design**

**02. on-board experience**

**03. multimedia**

**04. spaciousness**

**05. driving pleasure**

**06. safety**

**07. customisation**

**pdf to be downloaded**

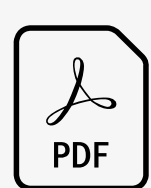

**equipment and engine options**



## avant-garde elegance

**Its assertive personality defines the exterior style of Renault Symbioz. A long coupé, its dimensions remain compact to adapt to your needs. With its robust and refined grille with the new Renault identity, satin chrome logo and half-diamond lights, each element of the design accentuates its charisma.**



**The radiator grille, made up of micro-diamonds, is adorned with a graphic effect. At the rear, the Symbioz signature emphasises the sharp lines.**





# esprit Alpine

The Alpine spirit stands out through a number of distinctive features, including the matte grey F1 strip.



Special 19" esprit Alpine 'elixir' wheels and Alpine badge on the front wings for more sportiness. On board, the upholstery is stitched in the iconic Alpine blue and the distinctive badge features a blue/white/red flag on the seat backs and dashboard.

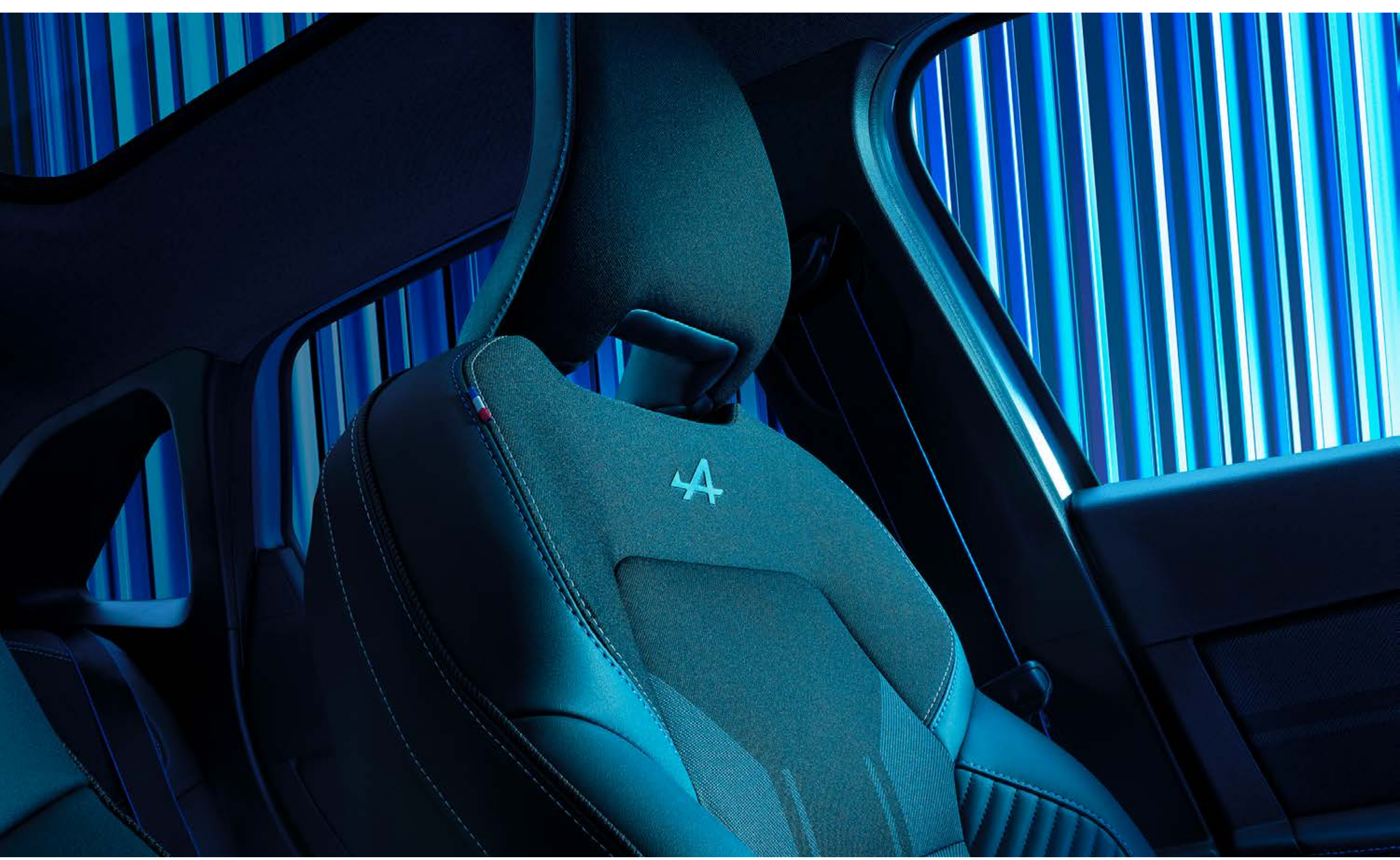

[configure and order →](#)



## connect with well-being

Take a seat in a high-tech cockpit that enhances driving pleasure. With its steering wheel controls, the dashboard is streamlined and driving is simplified. Every passenger can enjoy the innovative view offered by the solarbay® opacifying panoramic sunroof<sup>(1)</sup> and the customised sound environment created by Harman Kardon®<sup>(1)</sup>. Whatever the journey, share the fun with family and friends.

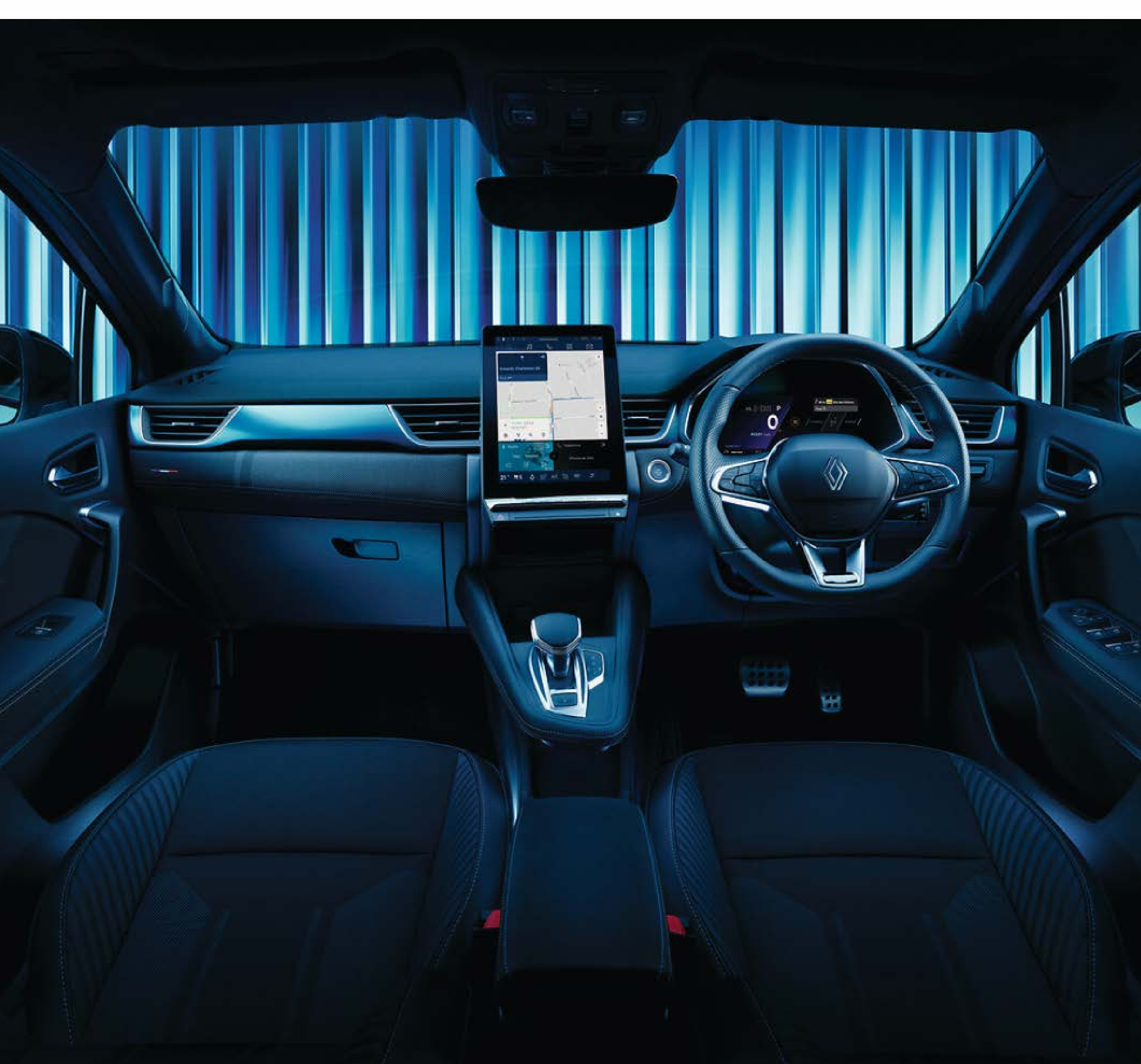

The solarbay® technology can be activated by voice using Google Assistant<sup>(2)</sup> or manually using a button on the ceiling light. Adjustable to 4 different opacity configurations, it maintains light and heat comfort on board in both summer and winter.



The passenger compartment has a wireless charging point. Lay down your smartphone and your device stays charged wirelessly without interruption.



(1) only available on iconic esprit Alpine. (2) My Renault, Google Maps and Google Assistant connected services are provided free of charge for 5 years from the date of delivery of your vehicle. Thereafter, additional charges may apply. Google, Google Maps, Google News, Waze and other brand names are all trademarks of Google LLC.



**Immerse yourself in the exclusive Harman Kardon® sound<sup>(1)</sup> experience and enjoy the most beautiful emotions: 9 speakers distributed throughout the cabin and designed to deliver the same captivating sound quality in each seat.**

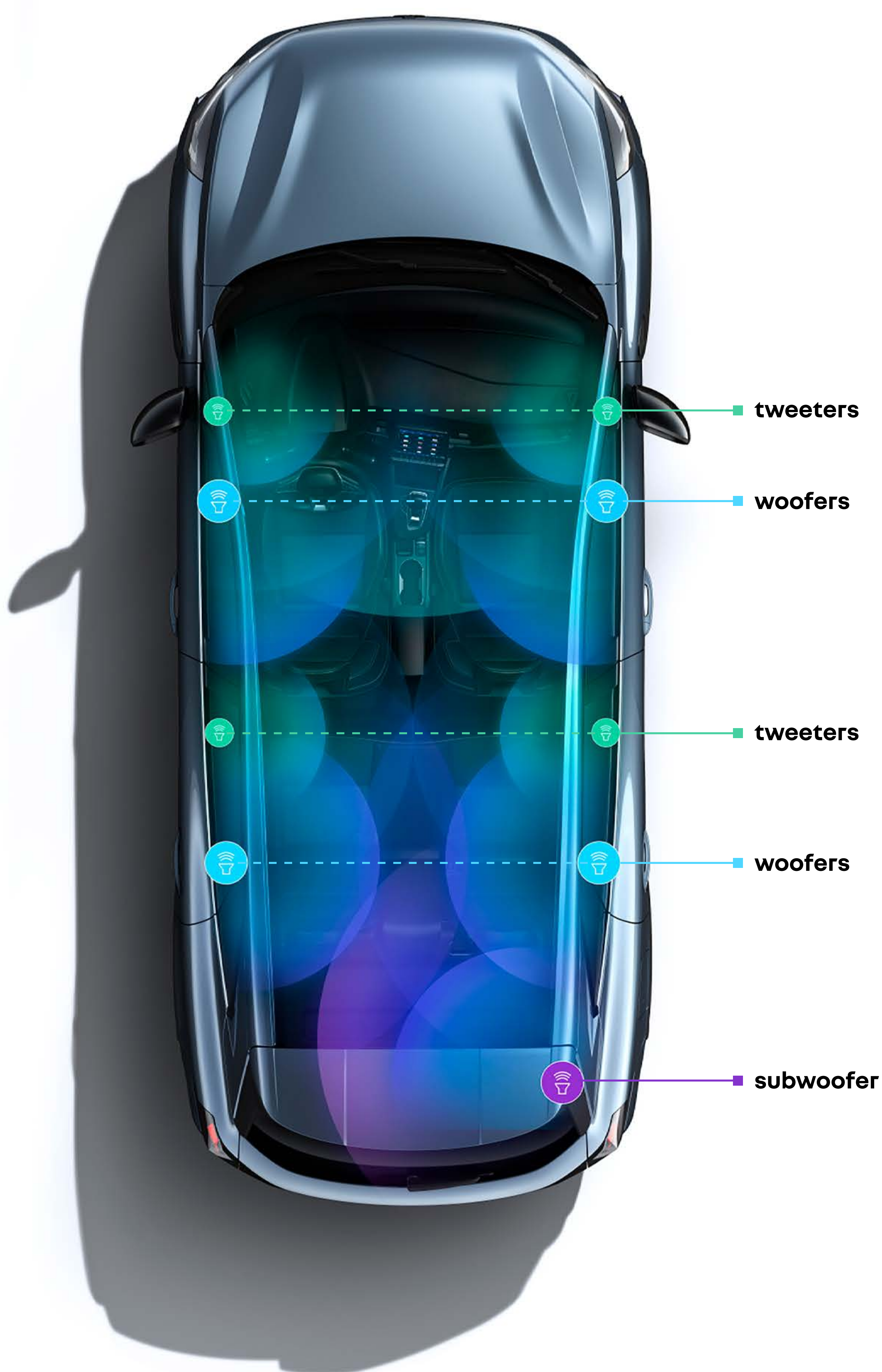

(1) only available on iconic esprit Alpine.

**configure and order →**



## openR link multimedia system with Google built-in

The 10.4" central display and the 10.25" digital driver display connect you to the best of technology thanks to the openR link multimedia system with Google built-in<sup>(1)</sup>.

Enjoy more than 50 apps for a shared experience.



**Google Maps<sup>(2)</sup> provides accurate navigation even if the network goes down, informing you of road closures, changes to the direction of traffic, road works, etc.**

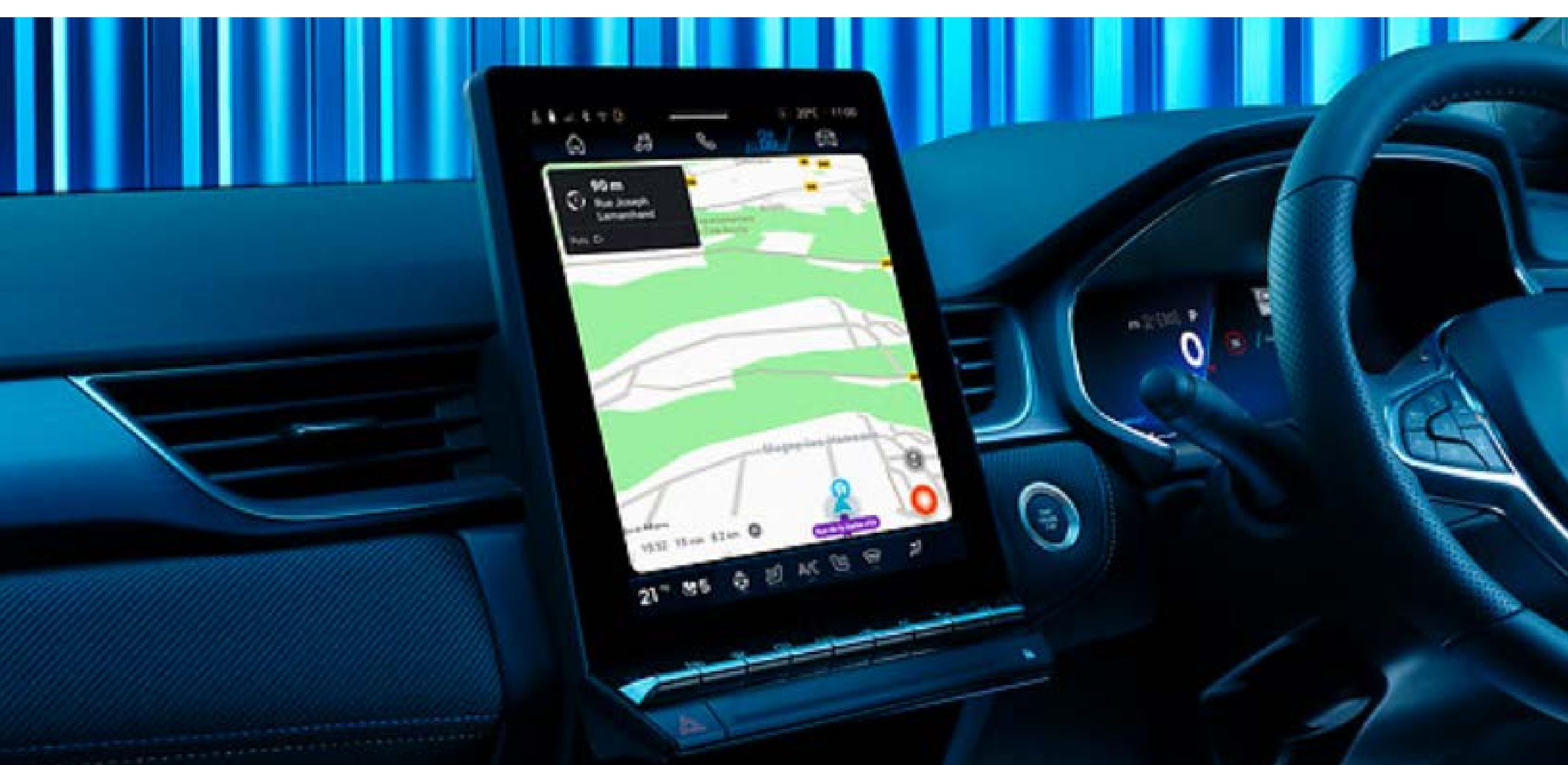

**"Hey Google..." Talk to it to plan a trip, adjust vehicle temperature or adjust the opacity of the solarbay<sup>®</sup> panoramic sunroof. The voice assistant is there for you.**



**Over 50 apps with exclusive content are available via Google Play<sup>(3)</sup>, including Waze, SongPop for Renault, and Amazon Music.**



**Waze** is a community-based navigation app that shares information in real time. Waze boosts your peace of mind.



Drive to the beat with our new musical game - **SongPop** for Renault. Play together and rediscover popular songs with your family and friends!

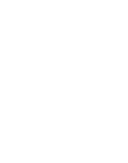

Take to the road while listening to playlists, and much more, with **Amazon Music**, included with your Amazon Prime subscription.

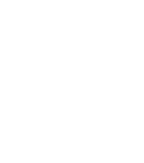

With **EasyPark**, you can plan and book millions of parking spaces across Europe. Enter your destination's address or navigate using the map.



**Vivaldi** browser is an efficient, fast Web browser that respects your privacy.



Access all your favourite radio stations live, at any time, in France or abroad, with **RadioPlayer**.

(1) Google, Google Maps, Google News, Waze and other marks are trademarks of Google LLC. (2) My Renault, Google Maps and Google Assistant connected services are provided free of charge for 5 years from the date of delivery of your vehicle. Thereafter, additional charges may apply. (3) To use Connected Services (such as applications downloaded from Google Play) you need a smartphone with compatible iOS or Android operating system. Connecting a smartphone to use the services should only be done when the car is parked safely. Services may be subject to mobile network coverage and additional charges. Users should follow road safety regulations when using the services and always be in control of the vehicle.

[configure and order →](#)



## the space adapts to you

The spacious passenger compartment has the ideal dimensions and modular design for perfect versatility, with electric front seats<sup>(1)</sup>, 22 cm of legroom in the rear and a folding rear bench seat. The innovative upholstery with bio-sourced materials combines comfort and elegance.



With the rear bench seat folded down, you have a total volume of 1,582 litres<sup>(2)</sup> to carry your luggage, groceries or equipment. The practical hands-free system allows the tailgate to be opened with one foot movement.



Save space in a flash. Thanks to the sliding rear bench seat with 16 cm of travel, the boot capacity is increased from 492 litres to 624 litres.

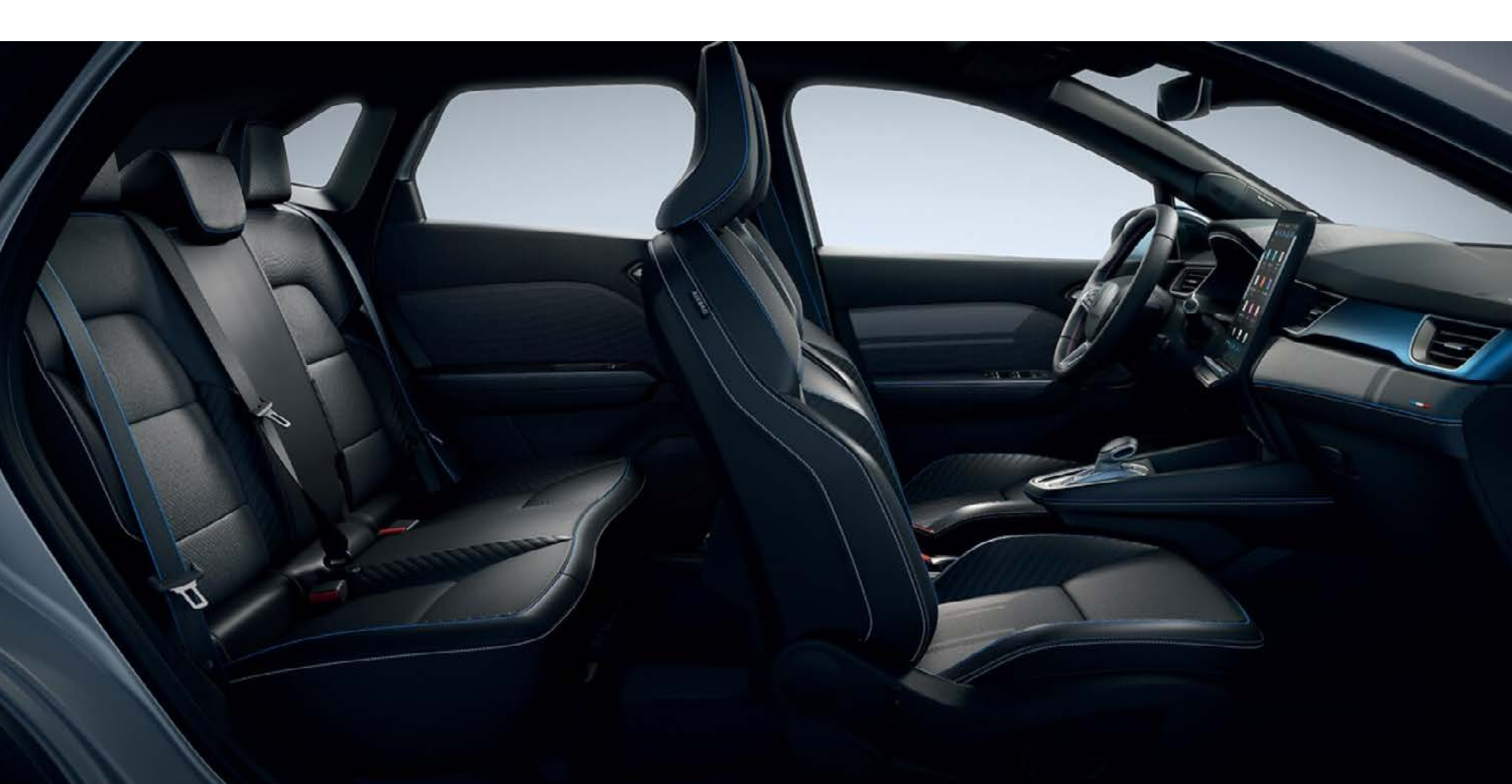

(1) on techno esprit Alpine and iconic esprit Alpine. (2) with bench seat folded down.

[configure and order →](#)



## 05. driving pleasure

# E-Tech full hybrid engine

E-Tech  
full hybrid  
145 hp

up to  
**630 miles**  
of driving range<sup>(1)(3)</sup>

up to  
**60.1 mpg**  
of fuel consumption<sup>(2)(3)</sup>

from  
**105 g/km**  
CO<sub>2</sub> emissions



**Treat yourself to hybrid driving with Renault Symbioz. Enjoy dynamic acceleration while reducing your fuel consumption and CO<sub>2</sub> emissions. Thanks to regenerative braking, the battery recharges automatically when you brake or decelerate. No need to plug your vehicle into a power outlet.**

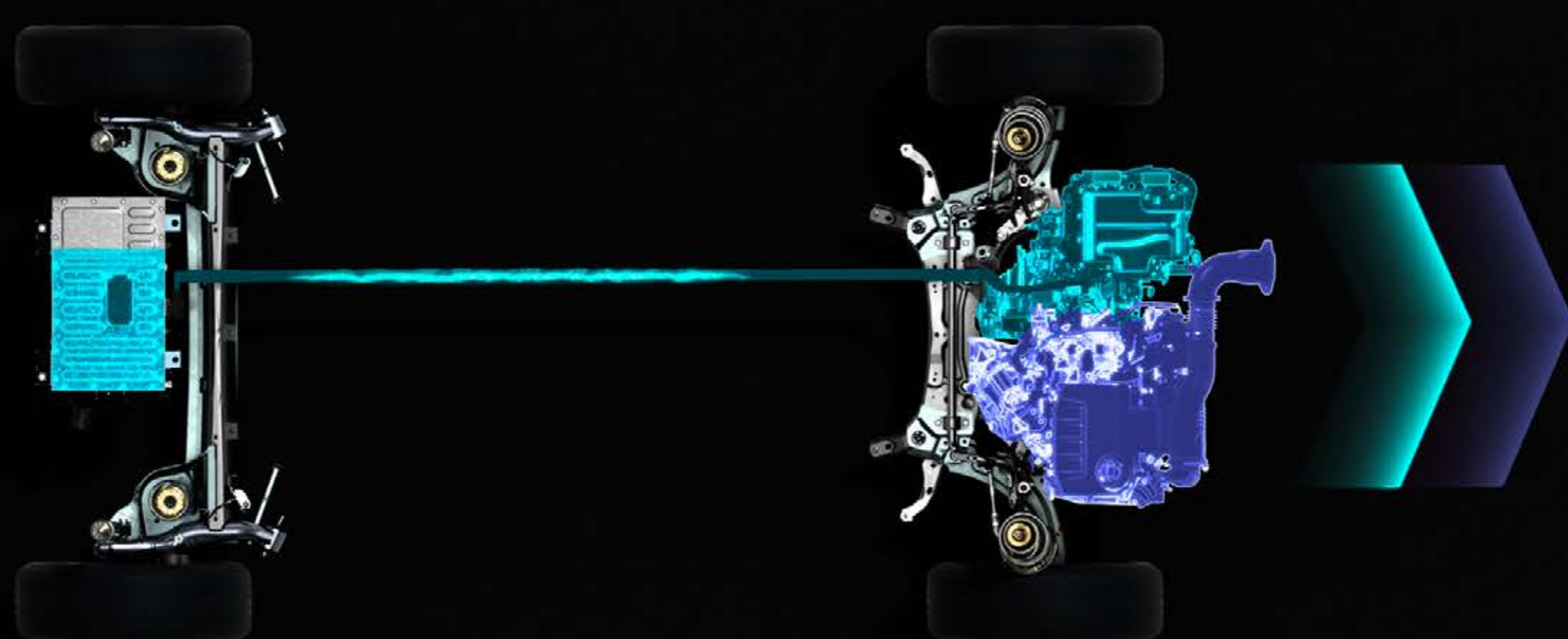

(1) internal source, based on new Symbioz E-Tech iconic esprit Alpine vs WLTP fuel consumption figures. (2) in WLTP combined cycle. (3) Figures shown are for comparability purposes only. Actual real world driving results may vary depending on factors including the starting charge of the battery, accessories fitted after registration, weather conditions, driving styles and vehicle load.

[configure and order →](#)



## 06. safety



# 24 advanced driver assistance systems\*



**active driver assist<sup>(1)</sup>**  
This system regulates your speed by taking the road environment into account, maintains safe distances and ensures you remain in lane. When traffic slows down, the vehicle stops and restarts automatically.

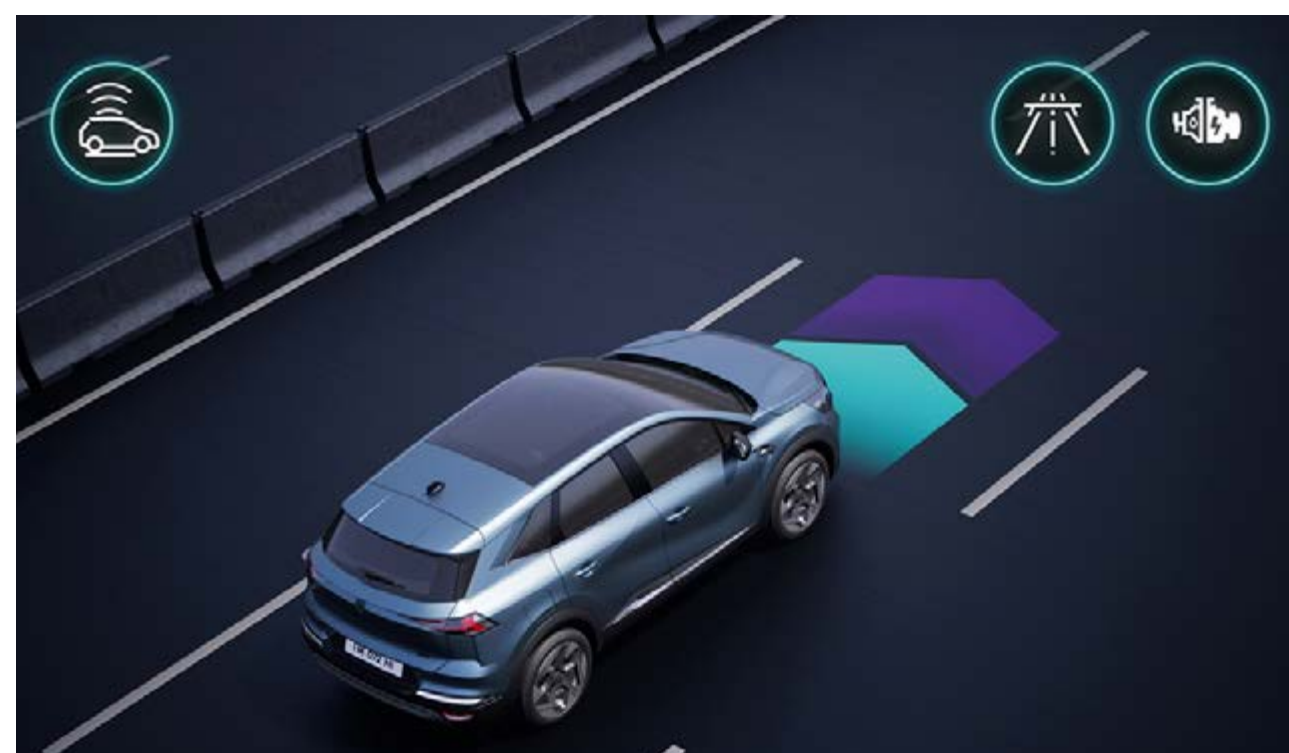

**predictive hybrid driving**  
Your car anticipates combustion engine, hybrid or 100% electric driving by continuously analysing your route to establish the time at which you shall drive through a town or whether you risk encountering a particular topography or a traffic jam. As a result, you improve the fuel consumption and performance of your vehicle.



**360° around view camera<sup>(2)</sup>**  
The 4 cameras, whose images recreate the vehicle's direct environment 360° around it, allow you to perform your manoeuvres effortlessly.



**rear active emergency braking<sup>(1)</sup>**  
This system detects obstacles at the rear and stops the vehicle automatically in the event of danger.

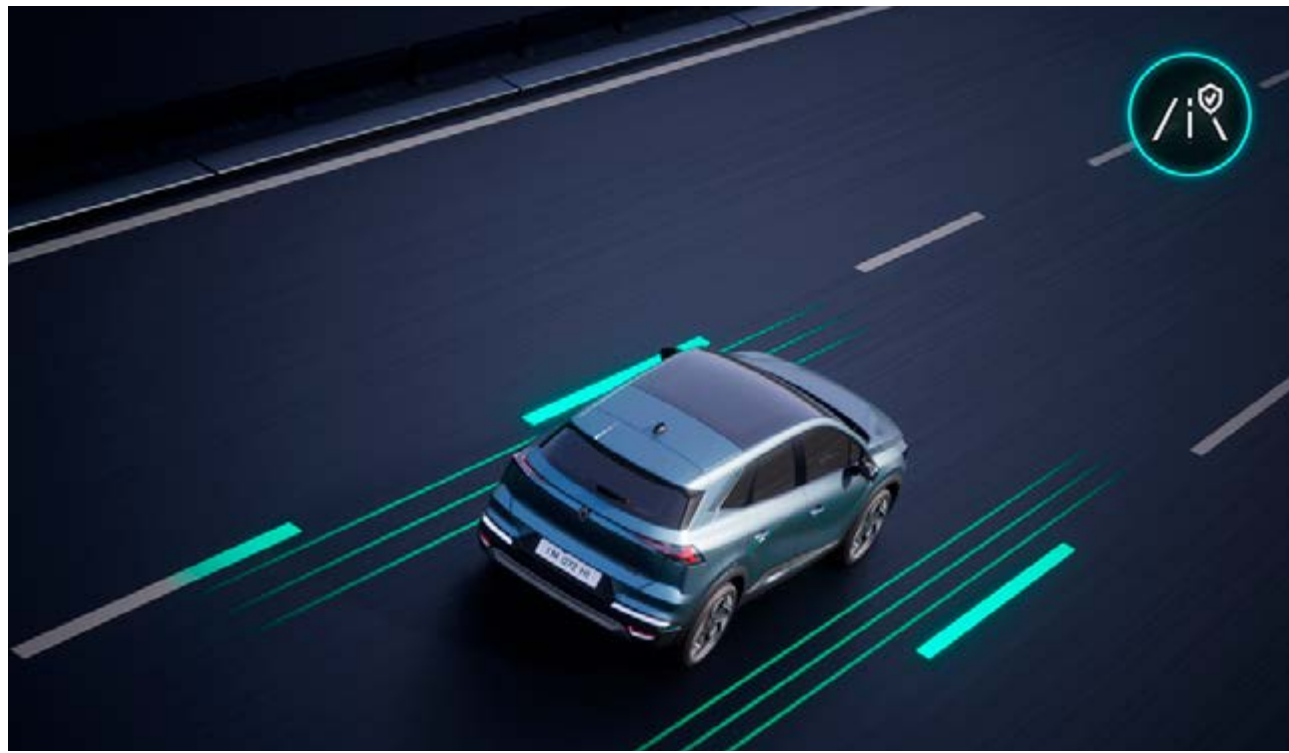

**lane keeping assist**  
This system corrects the angle of the steering wheel, returning the vehicle to its lane unless you have indicated.



**occupant safe exit alert<sup>(1)</sup>**  
This system alerts you if a vehicle is approaching from the rear when you want to open the door.

### driver assistance

- active driver assist<sup>(1)</sup>
- hill start assist
- distance warning alert
- predictive eco-driving assistant
- predictive hybrid driving
- speed limiter
- adaptive cruise control

### park assist systems

- rear parking sensors
- front parking sensors
- side parking sensors
- rear view camera
- 360° around view camera<sup>(2)</sup>
- hands-free parking<sup>(2)</sup>

### safety assistance systems

- lane departure warning
- occupant safe exit alert<sup>(1)</sup>
- lane keeping assist
- blind spot warning and rear detection with emergency lane keep assist<sup>(1)</sup>
- rear cross traffic alert<sup>(1)</sup>
- automatic high/low beam
- front & rear detection with emergency lane keep assist [including solid line, oncoming traffic & road edge detection]
- traffic sign recognition with overspeed prevention
- driver attention alert

(1) on techno esprit Alpine and iconic esprit Alpine. (2) only on iconic esprit Alpine.

\*Always follow road safety regulations. It is your responsibility to stay alert, drive safely and be in control of the vehicle at all times. You should not solely rely on driver convenience and assistance features. Some features may not work in all conditions and circumstances, and they have speed and other limitations.

[configure and order →](#)



## 07. customisation

# colours



**mercury blue<sup>(1)</sup>**



**oyster grey**



**ceramic grey**



**diamond black**



**arctic white**



**flame red**



**iron blue**

(1) not available on esprit Alpine versions.

**configure and order →**



## 07. customisation

# interior trims



### **techno**

- granite grey decorative upper strip
- height-adjustable driver and passenger seats
- 10.4" openR link: connected multimedia system with Google built in
- 10.25" digital driver display



### **techno esprit Alpine (techno +)**

- brushed blue decorative upper strip
- heated front seats
- Alpine marking and red, white & blue flag on front seats
- heated synthetic leather steering wheel
- aluminium sports pedals
- electrically adjustable front seats



### **iconic esprit Alpine (techno esprit Alpine+)**

- solarbay® opacifying panoramic sunroof
- Harman Kardon premium audio
- hands-free parking
- 360° around view camera



**download the PDF (6 MB)  
of the trims and equipment**



## 07. customisation

# upholstery



**embossed marled black fabric / titanium black biosourced grained coated fabric with yellow top-stitching**



**26% recycled fabric / titanium black grained coated fabric with blue top-stitching**

# wheels



**18" 'gravity' alloy wheels**



**19" esprit Alpine 'elixir' alloy wheels**

**configure and order →**



## 07. customisation

# accessories



### side step pack

With premium side steps, enhance its design and easily access roof loading.



### touring pack

With quickfix roof mounted bars you can easily transport a roof box.



### cycle pack

You can also transport a bike with a cycle pack.



### protection pack

Pack includes illuminated door sills to enhance the look of your vehicle as well as a boot liner and a boot sill to ensure complete protection.



### family pack

For a premium experience, transform, the armrest into a stylish backpack for practical and stylish storage of your items. The multifunction organiser has a number of clever places to store all of your everyday items.

[configure and order →](#)



## 07. customisation

# engine

### E-Tech full hybrid 145

#### fuel

unleaded fuel (E10) + electric

#### maximum power kW (hp)

105 kW (145)

#### maximum torque (Nm)

149 at 3,600 rpm (internal combustion engine) + 205 (electric motor)

#### gearbox

automatic (clutchless smart multimode)

#### kerb weight (excluding 75 kg driver weight) (kg) techno / techno esprit Alpine / iconic esprit Alpine

1426 / 1432 / 1447

#### battery

##### type

lithium-ion (68 cells)

##### voltage (V)

150 - 285

##### capacity (kWh)

1.26

#### fuel consumption and emissions

##### combined consumption (mpg)

60.1

##### combined WLTP consumption (L/100 km)

4.7

##### combined WLTP CO<sub>2</sub> (g/km)

105-107



**download the  
engines pdf (6 MB)**



# dimensions and volumes

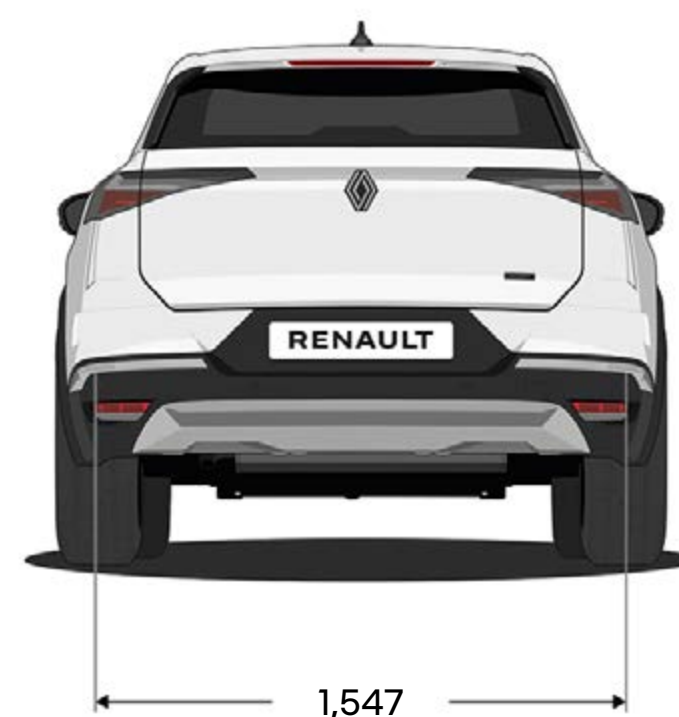
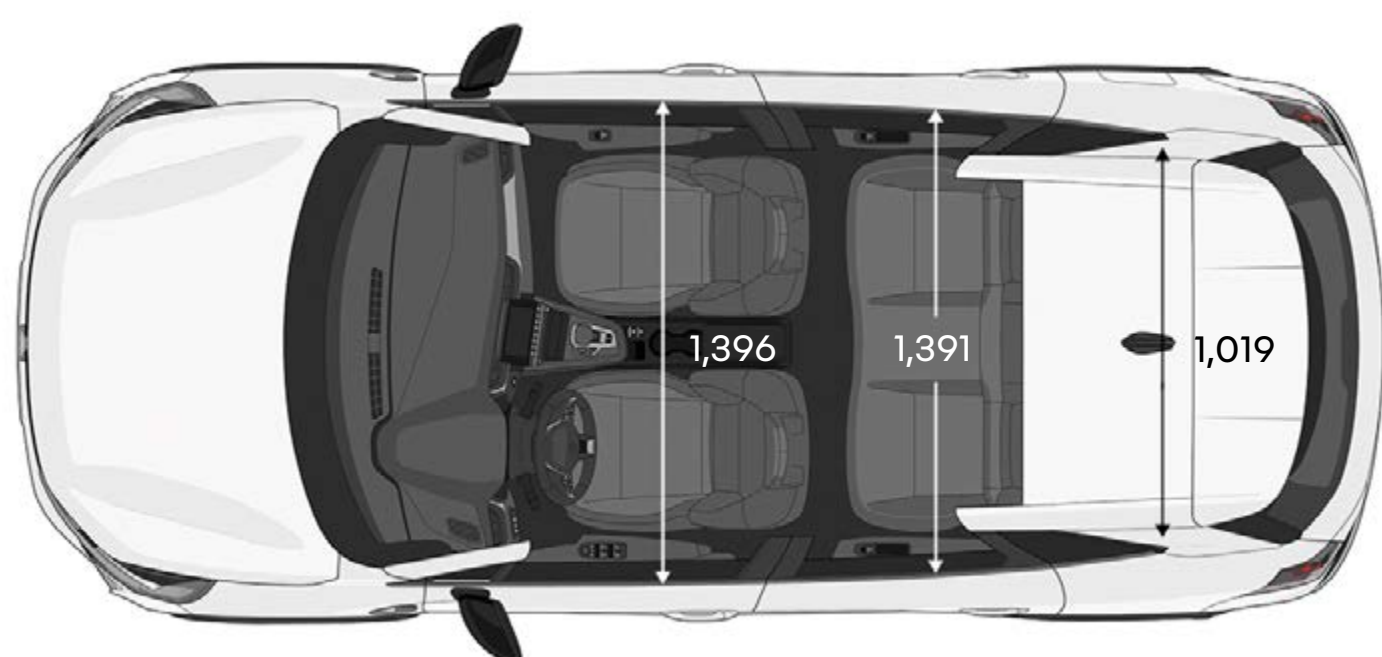
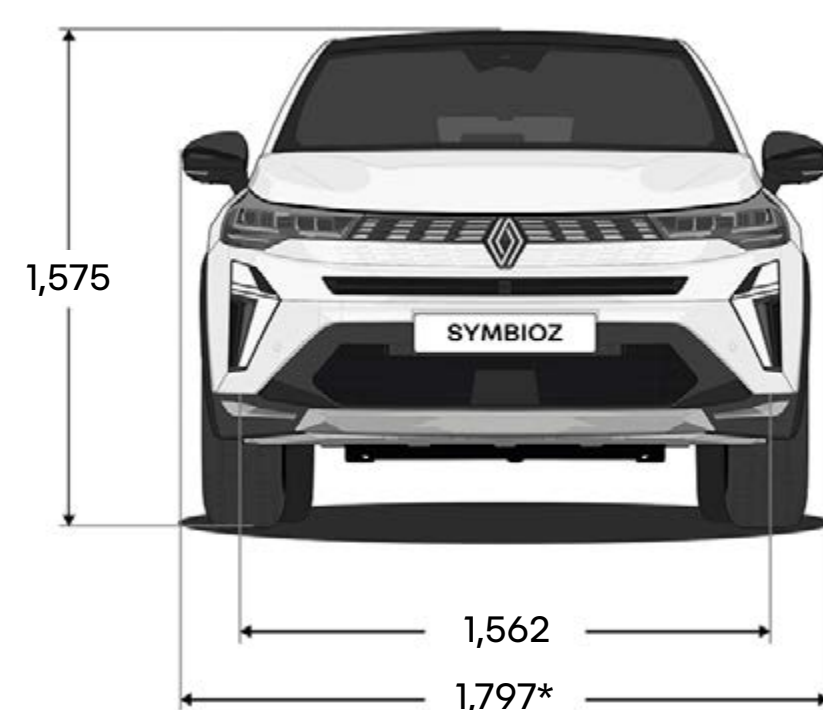
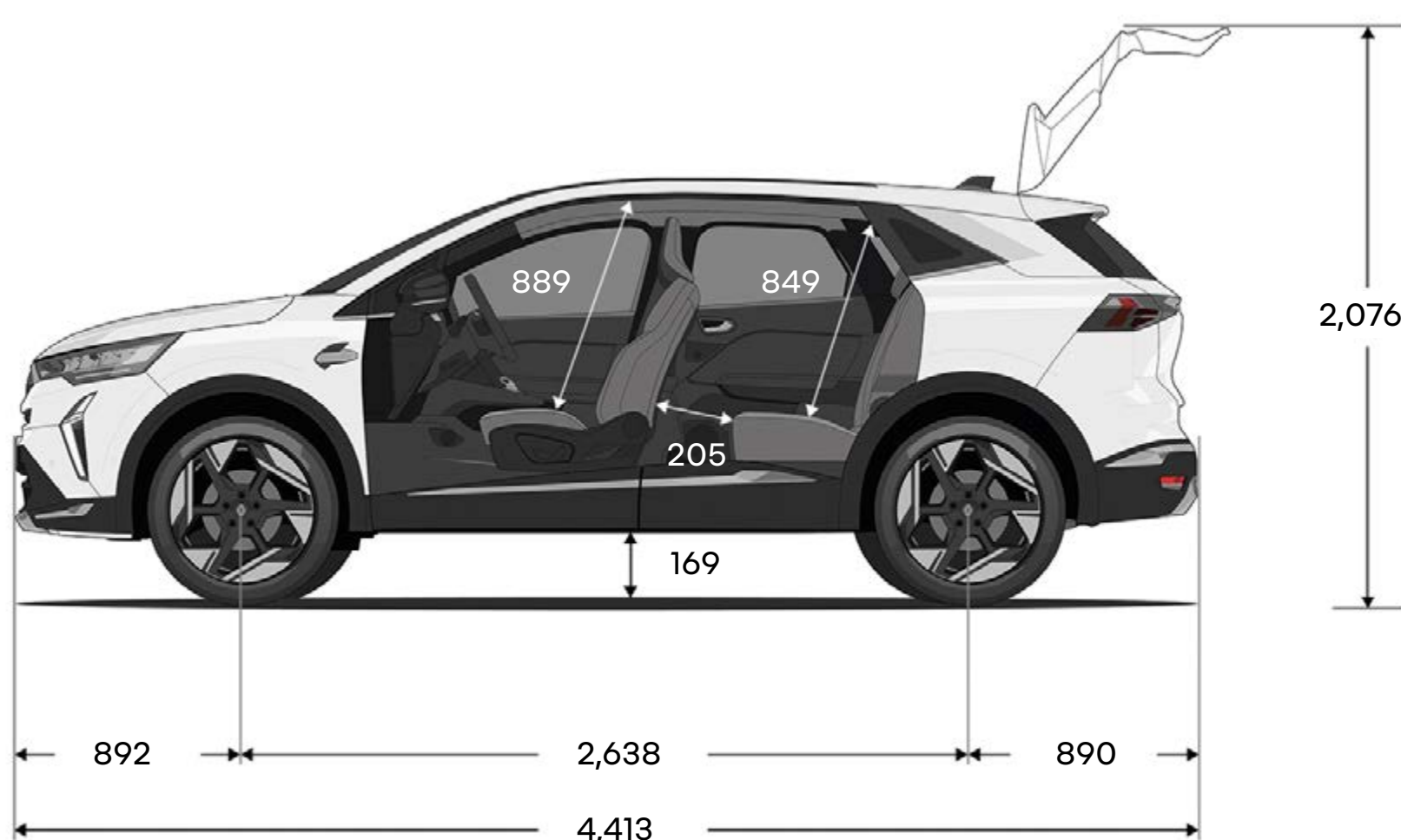

## boot volume (in litres)\*\*

boot volume, bench seat in rear position	492
boot volume, bench seat in forward position	624
boot volume, bench seat folded down	1,582

dimensions in (mm).

\* door mirrors folded. \*\* the equivalent volume measured according to VDA standard (ISO 3832) is 434, 548, 1498 dm<sup>3</sup> for the E-Tech full hybrid version (the VDA standard involves measuring the total volume of the boot using standardised shape and volume objects (200 mm x 100 mm x 50 mm = 1 dm<sup>3</sup>)).

[configure and order →](#)



# Renault care service

**Replace what is necessary, at the right time. Thanks to its connected and predictive maintenance features, it is easy to service your Renault Symbioz. And thanks to the My Renault app, quotes, online appointments and even service history are at your fingertips.**

**[find out more about Renault care service](#)**





Every precaution has been taken to ensure that the contents of this brochure were accurate and up to date at the time of its release. This document was created using pre-production models and prototypes. In line with its policy of continuous product improvement, Renault reserves the right to modify the specifications, vehicles and accessories described and featured at any time. Any such modifications are communicated to Renault dealers as quickly as possible. Depending on the country of sale, versions may differ and some equipment may be unavailable (standard, optional or accessory). Please contact your local dealer for the latest information. For reasons to do with the medium, the colours featured in this document may differ slightly from those of the actual paintwork or interior trim. All rights reserved. Reproduction in any format and by any means of all or part of this brochure is prohibited without prior written authorisation from Renault.

Publicis - photo credits: © Akatre, Renault Marketing 3D-Commerce - July 2024.  
Renault s.a.s, a French simplified joint stock company with a share capital of € 533,941,113.00 / 122-122 quai Le Gallo - 92100 Boulogne-Billancourt Cedex, France - registered on the Trade and Companies Registry (R.C.S.) of Nanterre (Trade & Companies Register) B 780 129 987 / Tel.: 0806 00 20 20.

Renault recommends  **Castrol**



**configure and order →**