

2251

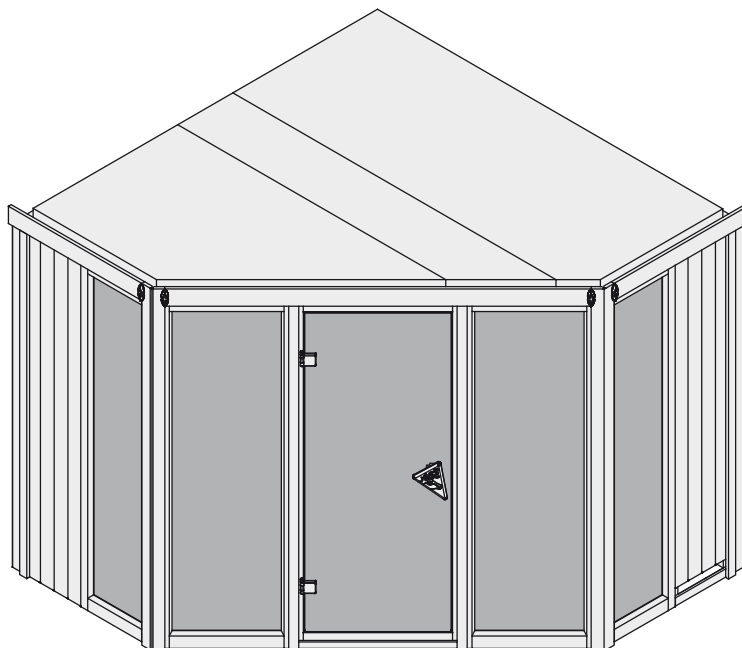

-  **Aufbauanleitung**
-  **Building Instructions**
-  **notice de montage**
-  **montagehandleiding**
-  **Montagevejledning**
-  **Instrucciones de construcción**
-  **Istruzioni per il montaggio**
-  **Montážní návod**

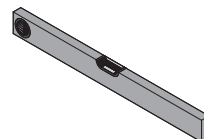

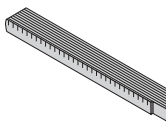
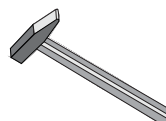
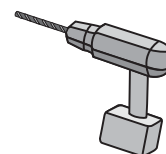
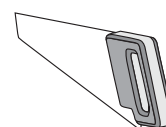

Vergleichen Sie zuerst die Material-liste mit Ihrem Paketinhalt! Bitte haben Sie Verständnis, dass Beanstandungen nur im nicht aufgebauten Zustand bearbeitet werden können!



Vergelijk eerst de lijst van materialen met de inhoud van uw pakket! Reclamaties kunnen alleen in behandeling worden genomen zolang de onderdelen nog niet zijn gemonteerd!



Confrontate questa distinta materiali prima con il contenuto del pacchetto! Vi preghiamo di comprendere che eventuali reclami possono essere accolti solo prima del montaggio!



First compare the list of materials with your package contents! Please understand that complaints can be processed in the non-built status only!



Start med at kontrollere materialelisten med indholdet af den leverede pakke! Vi gør venligst opmærksom på at reklamationer kun kan behandles for materialer som ikke er blevet bearbejdet!



Nejprve přezkontrolujte obsah balení podle materiálového listu! Mějte pochopení pro to, že případnou reklamaci se můžeme zabývat pouze tehdy, když díly nebudou smontované! Za pomoci tohoto seznamu můžete jednotlivé díly přiřadit k montážnímu návodu.



Commencez par comparer la liste du matériel avec le contenu de votre paquet! Sachez que nous traitons uniquement les réclamations concernant le matériel à l'état non monté!



En primer lugar, compare la lista de material con el contenido del paquete. Rogamos entienda que las reclamaciones sólo pueden ser tramitadas antes de montar el objeto!

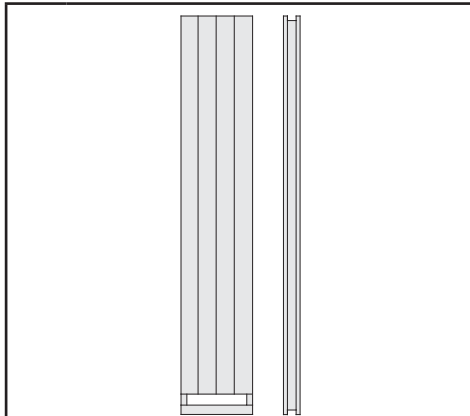
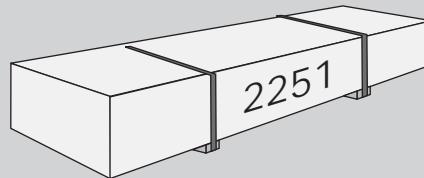

1 x W1 | 1920 x 344 x 68 mm | ID 2259

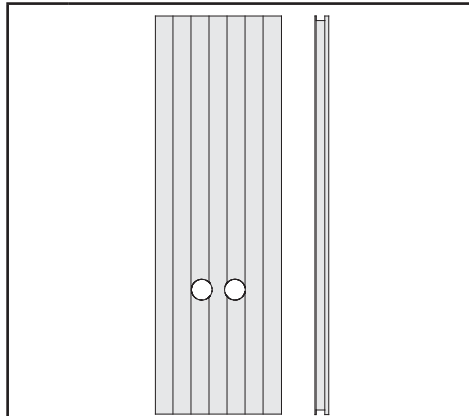

1 x W2 | 1920 x 606 x 57 mm | ID 23629

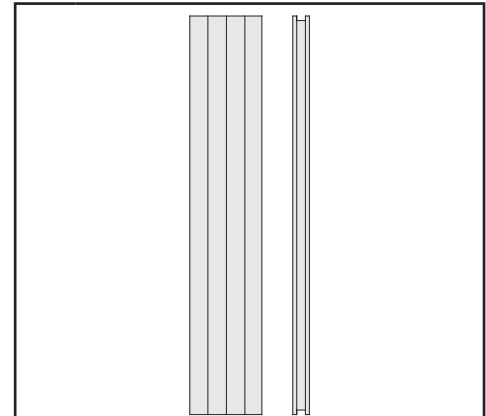

1 x W3 | 1920 x 344 x 68 mm | ID 52806

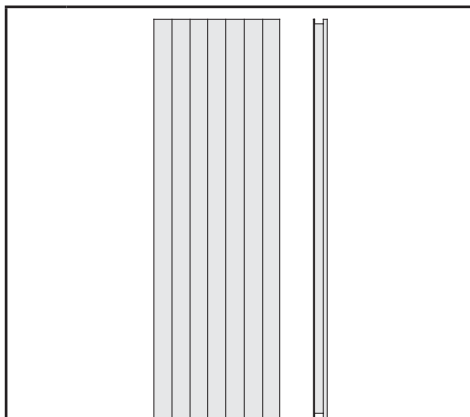

1 x W4 | 1920 x 606 x 57 mm | ID 23624

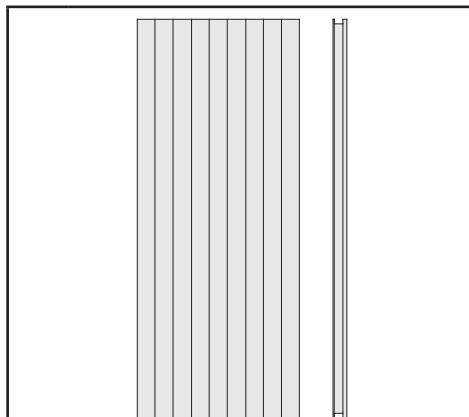

4 x W5 | 1920 x 780 x 57 mm | ID 23625

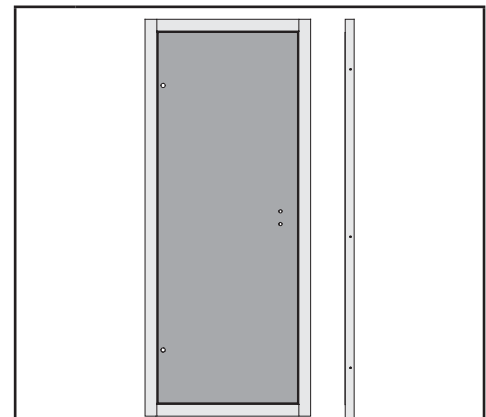

1 x W6 | 1872 x 750 x 68 mm | ID 43454

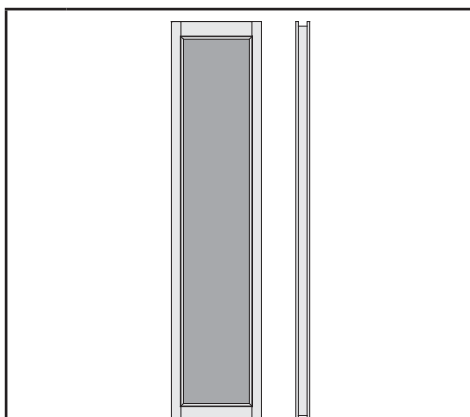

2 x W7 | 1920 x 433 x 68 mm | ID 56983

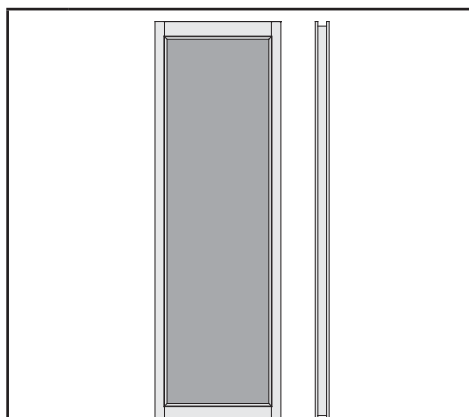

2 x W8 | 1920 x 606 x 68 mm | ID 47717

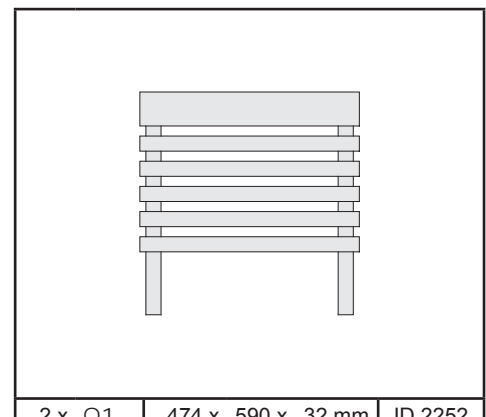

2 x Q1 | 474 x 590 x 32 mm | ID 2252
2 x Q2 | 580 x 590 x 32 mm | ID 2253

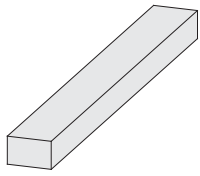

8 x B1	1920 x 19 x 3 mm	ID 20799
2 x B2	1920 x 20 x 12 mm	ID 52812
4 x B3	750 x 36 x 12 mm	ID 24239
1 x B4	964 x 90 x 16 mm	ID 2254
1 x B5	1255 x 90 x 16 mm	ID 2480
1 x B6	1606 x 90 x 16 mm	ID 2254
4 x B7	1884 x 45 x 18 mm	ID 48037
3 x B8	314 x 95 x 18 mm	ID 81102
2 x B9	845 x 95 x 18 mm	ID 52651
1 x B10	1912 x 95 x 18 mm	ID 52650
1 x B11	300 x 120 x 18 mm	ID 22467
1 x B12	1410 x 42 x 28 mm	ID 24101
1 x B13	2110 x 42 x 28 mm	ID 43453
1 x B14	2160 x 42 x 28 mm	ID 24529
2 x B15	2187 x 42 x 28 mm	ID 24534
2 x B16	2271 x 42 x 28 mm	ID 36179
3 x B17	1874 x 52 x 52 mm	ID 26165

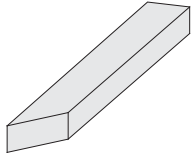

1 x C1	747 x 42 x 28 mm	ID 56491
1 x C2	774 x 42 x 28 mm	ID 56490
2 x C3	810 x 42 x 28 mm	ID 56632
2 x C4	852 x 42 x 28 mm	ID 56633

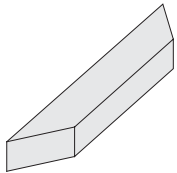

1 x C5	1960 x 42 x 28 mm	ID 56635
2 x C6	2007 x 42 x 28 mm	ID 56634

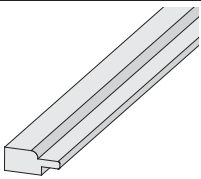

2 x E1	1920 x 30 x 12 mm	ID 24237
--------	-------------------	----------

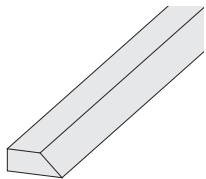

2 x E2	1884 x 45 x 17 mm	ID 48538
--------	-------------------	----------

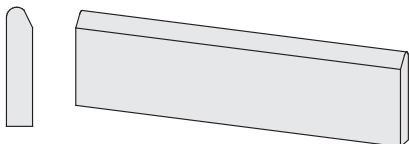

4 x G1	1980 x 58 x 17 mm	ID 52813
--------	-------------------	----------

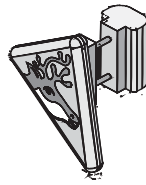

1 x		ID 26114
-----	--	----------

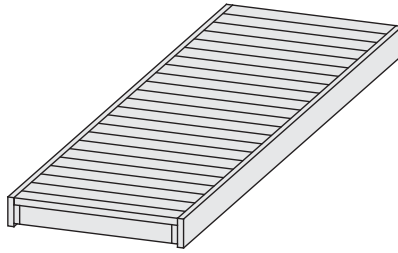

1 x L1	980 x 550 x 90 mm	ID 2478
1 x L2	1255 x 550 x 90 mm	ID 2477
1 x L3	2156 x 550 x 90 mm	ID 21768

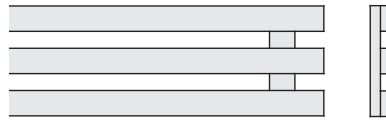

3 x L4	528 x 174 x 32 mm	ID 6917
1 x L5	947 x 174 x 32 mm	ID 2481
1 x L6	1236 x 174 x 32 mm	ID 2482
3 x L7	1606 x 174 x 32 mm	ID 2257

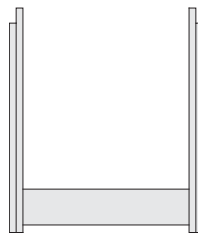

2 x L8	595 x 510 x 95 mm	ID 62992
2 x L9	895 x 512 x 95 mm	ID 16811

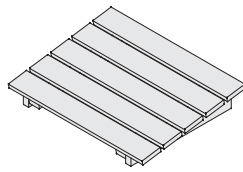

1 x L10	400 x 300 x 80 mm	ID 20708
---------	-------------------	----------

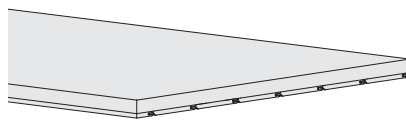

1 x M1	2049 x 349 x 57 mm	ID 25771
1 x M2	1699 x 918 x 57 mm	ID 25767

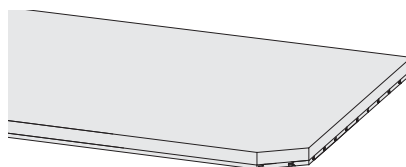

1 x M3	2187 x 918 x 57 mm	ID 24539
--------	--------------------	----------

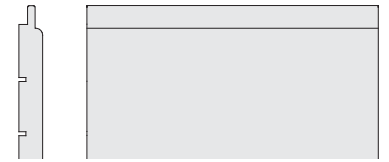

2 x R1	1920 x 97 x 12 mm	ID 22863
--------	-------------------	----------

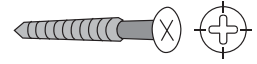

120 x	4 x 30 mm	ID 3686
60 x	4 x 50 mm	ID 3688
50 x	4 x 70 mm	ID 3689
40 x	4,5 x 80 mm	ID 9204
10 x	6 x 60 mm	ID 14014

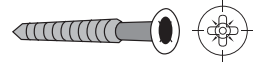

50 x	4,5 x 40 mm	ID 26285
------	-------------	----------

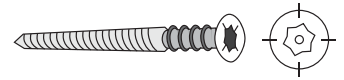

6 x	6 x 80 mm	ID 14266
-----	-----------	----------



50 x	4,5 x 30 mm	ID 26116
------	-------------	----------

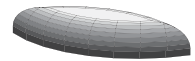

4 x		ID 26272
-----	--	----------



3 x	8 x 70 mm	ID 42172
-----	-----------	----------

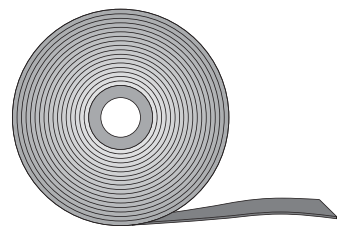

1 x	10 mm	ID 14025
-----	-------	----------

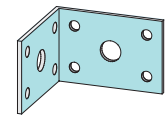

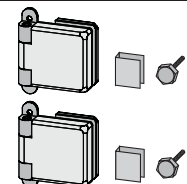

2 x	5 x 5 x 3,5 mm	ID 21292
-----	----------------	----------



1 x		ID 26496
-----	--	----------

 Übersicht
 Overview
 enquête

 overzicht
 undersøgelse
 estudio

 sondaggio
 přehled

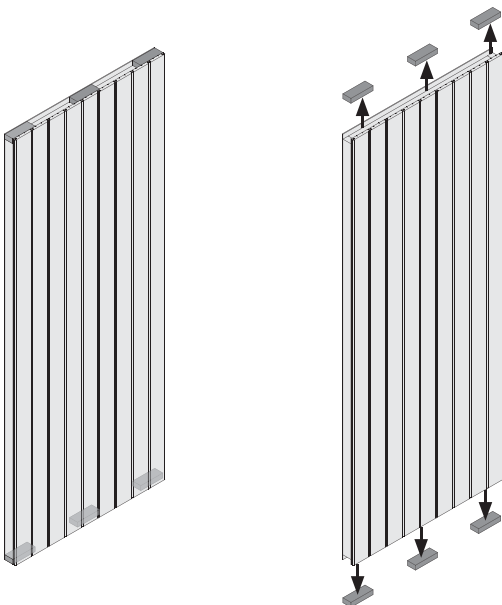
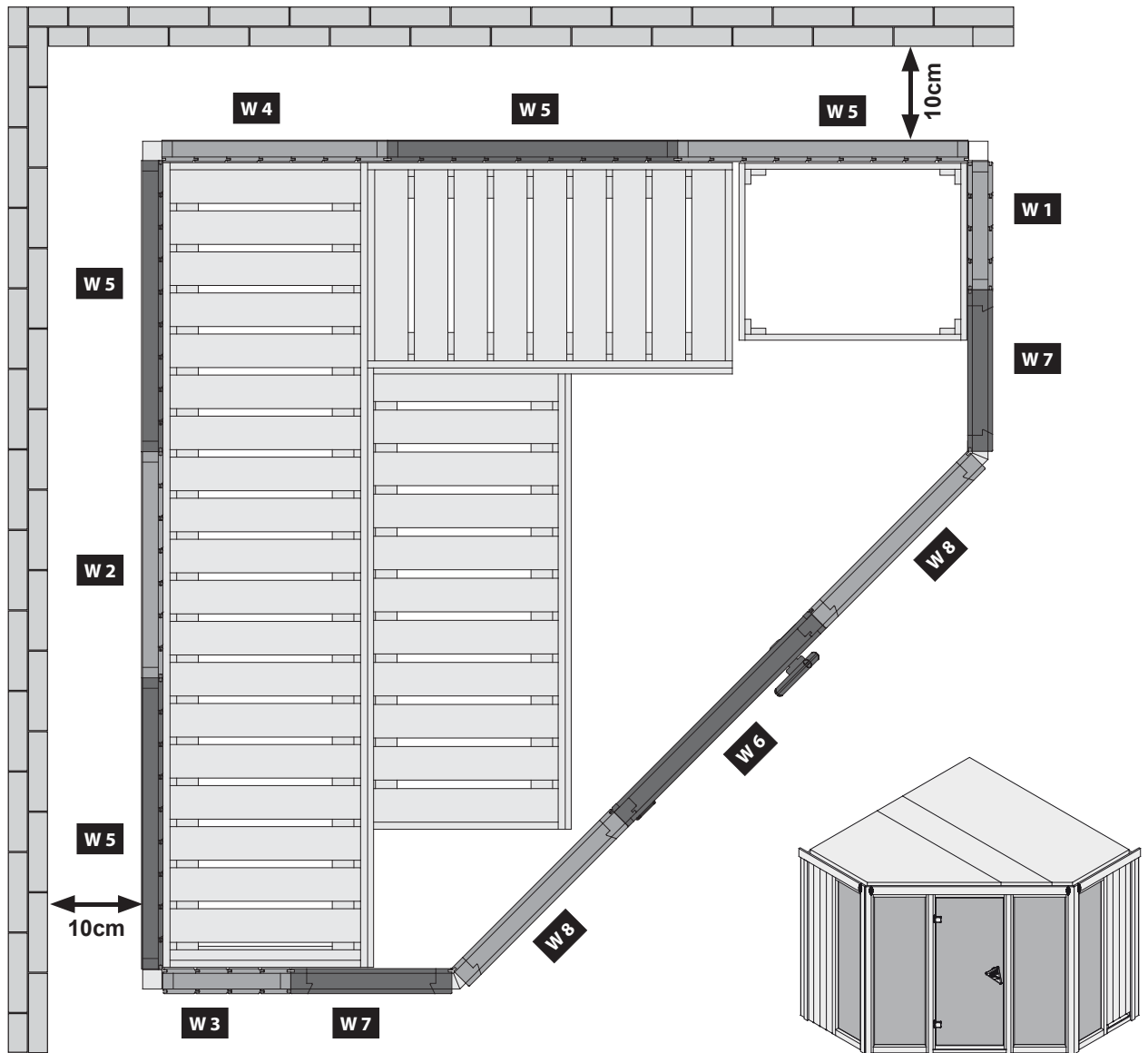



 Vorsicht!
 Attention!
 Attention!
 Voorzichtig!
 Forsigtig!
 Cuidado!
 Occhio!
 Pozor!

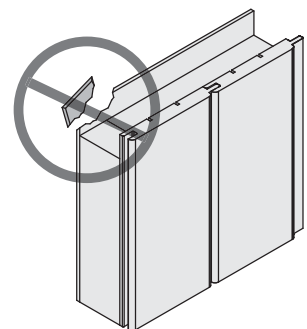

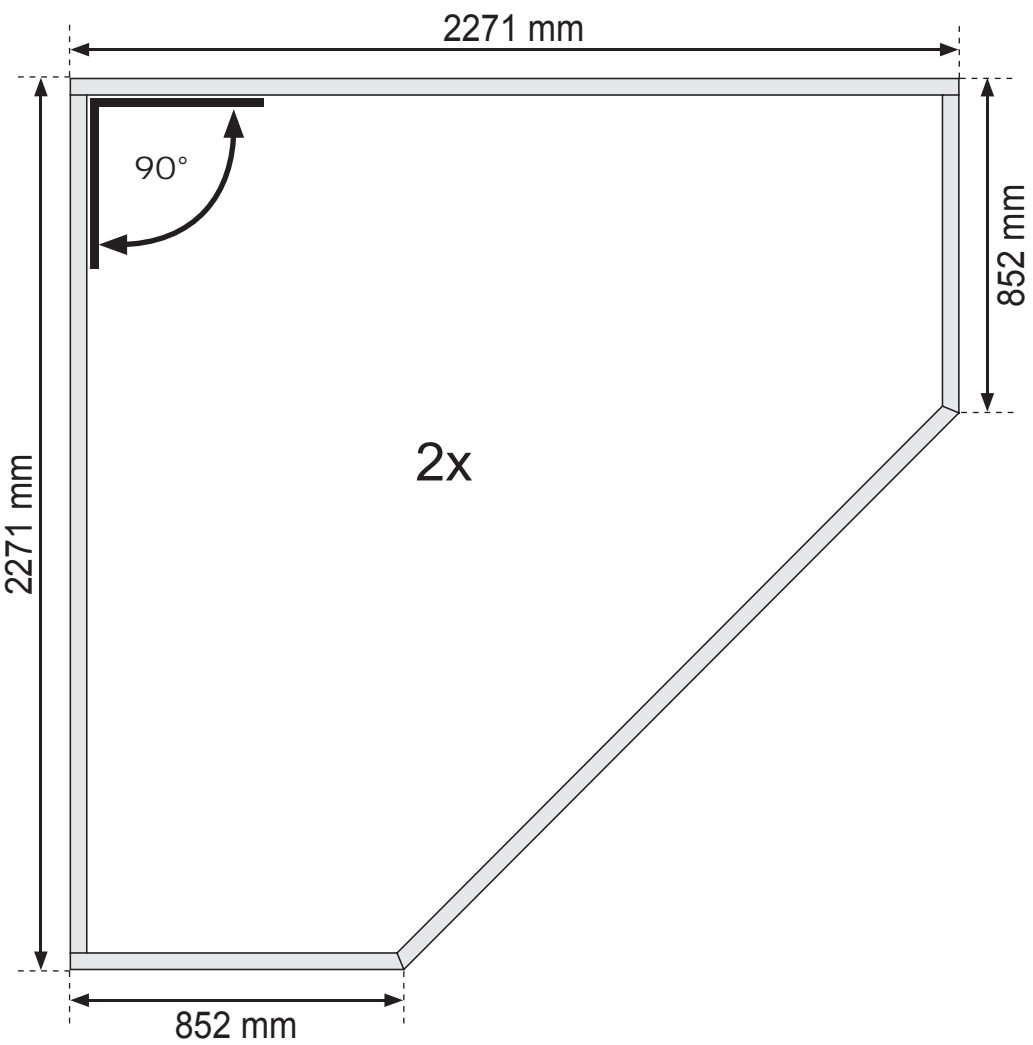
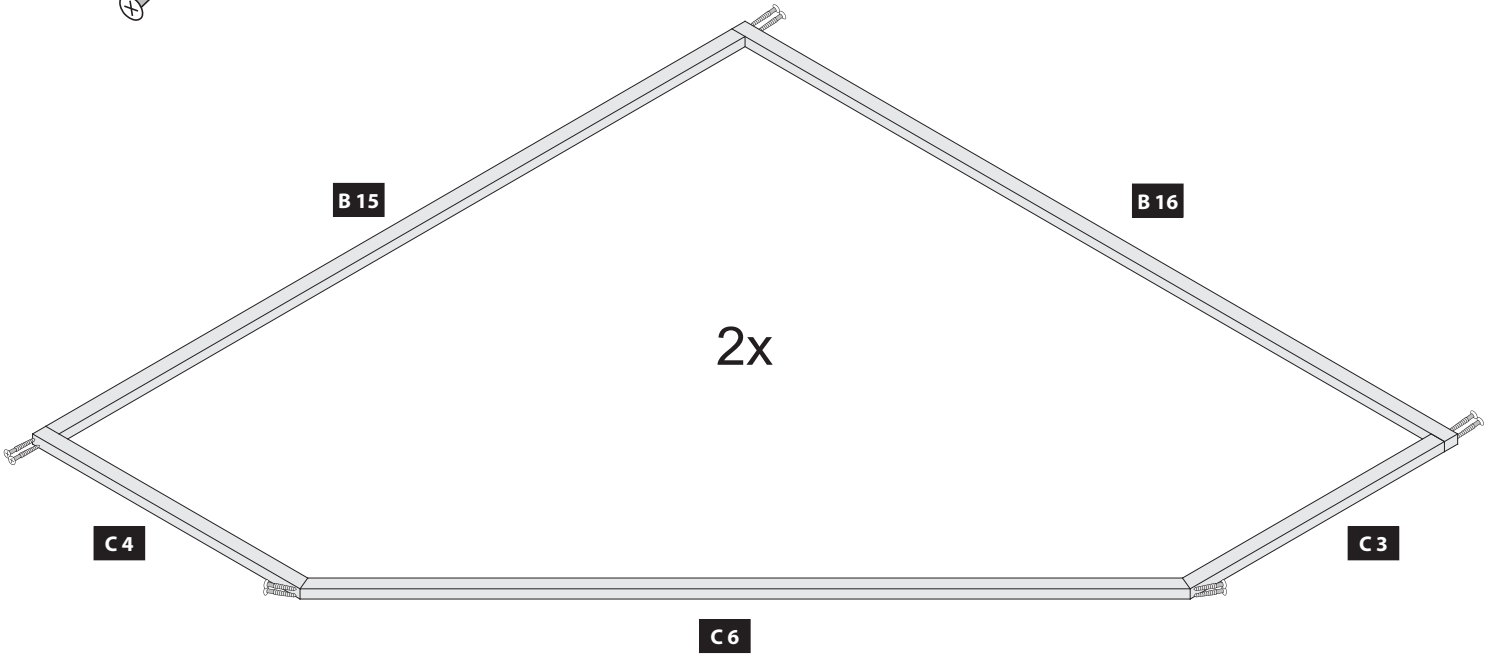
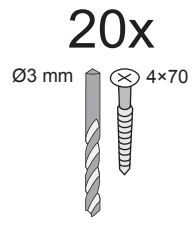
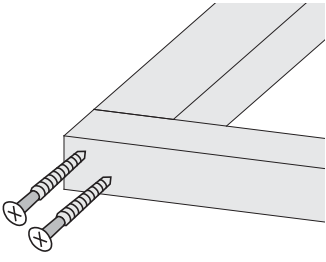

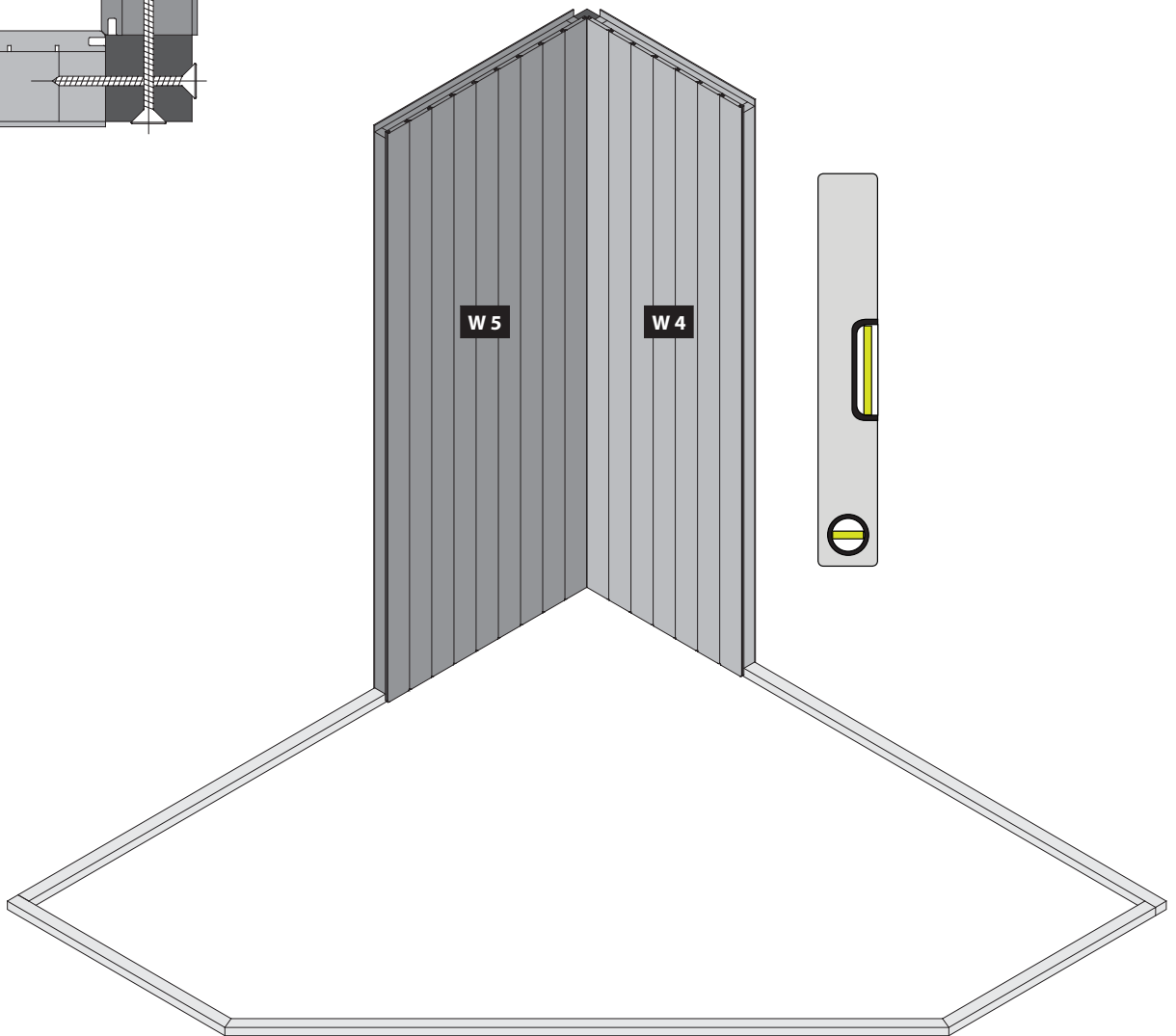
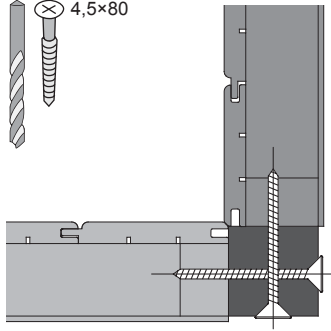
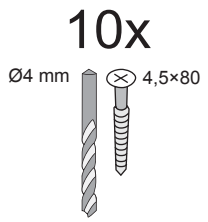
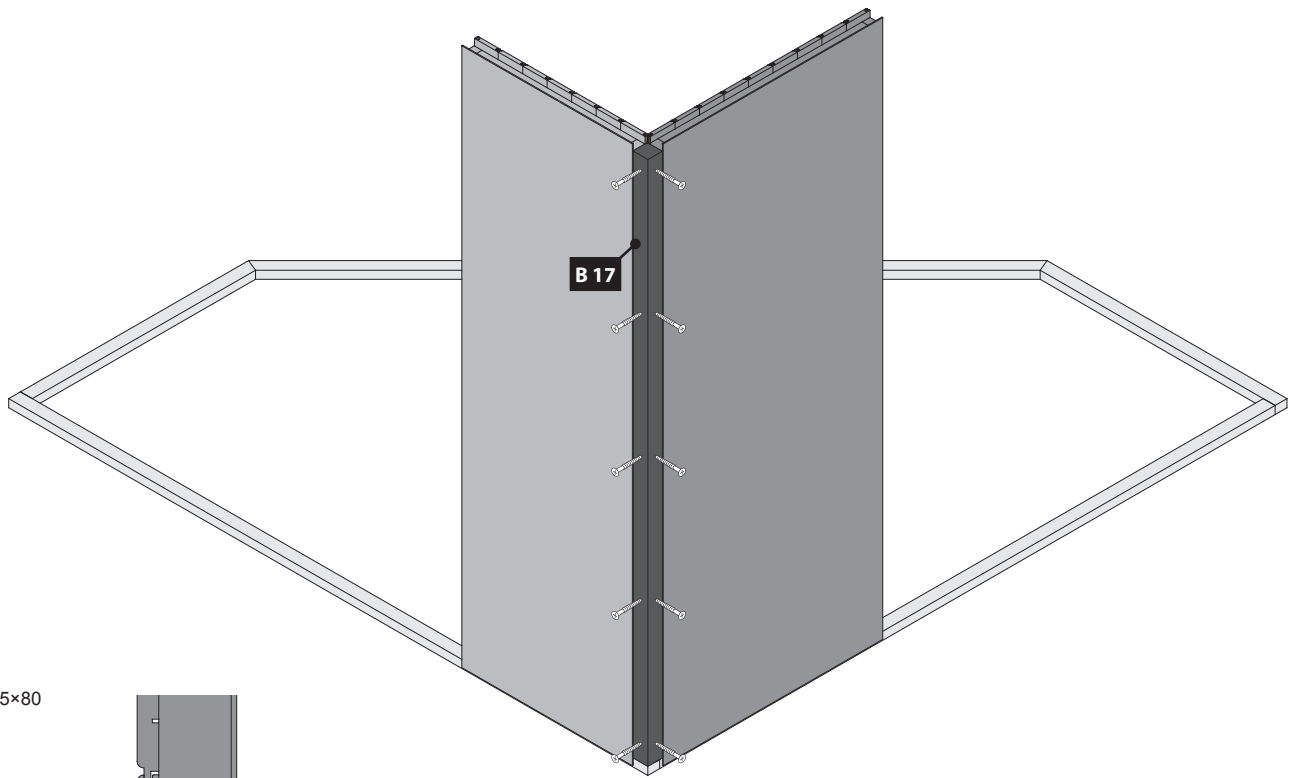

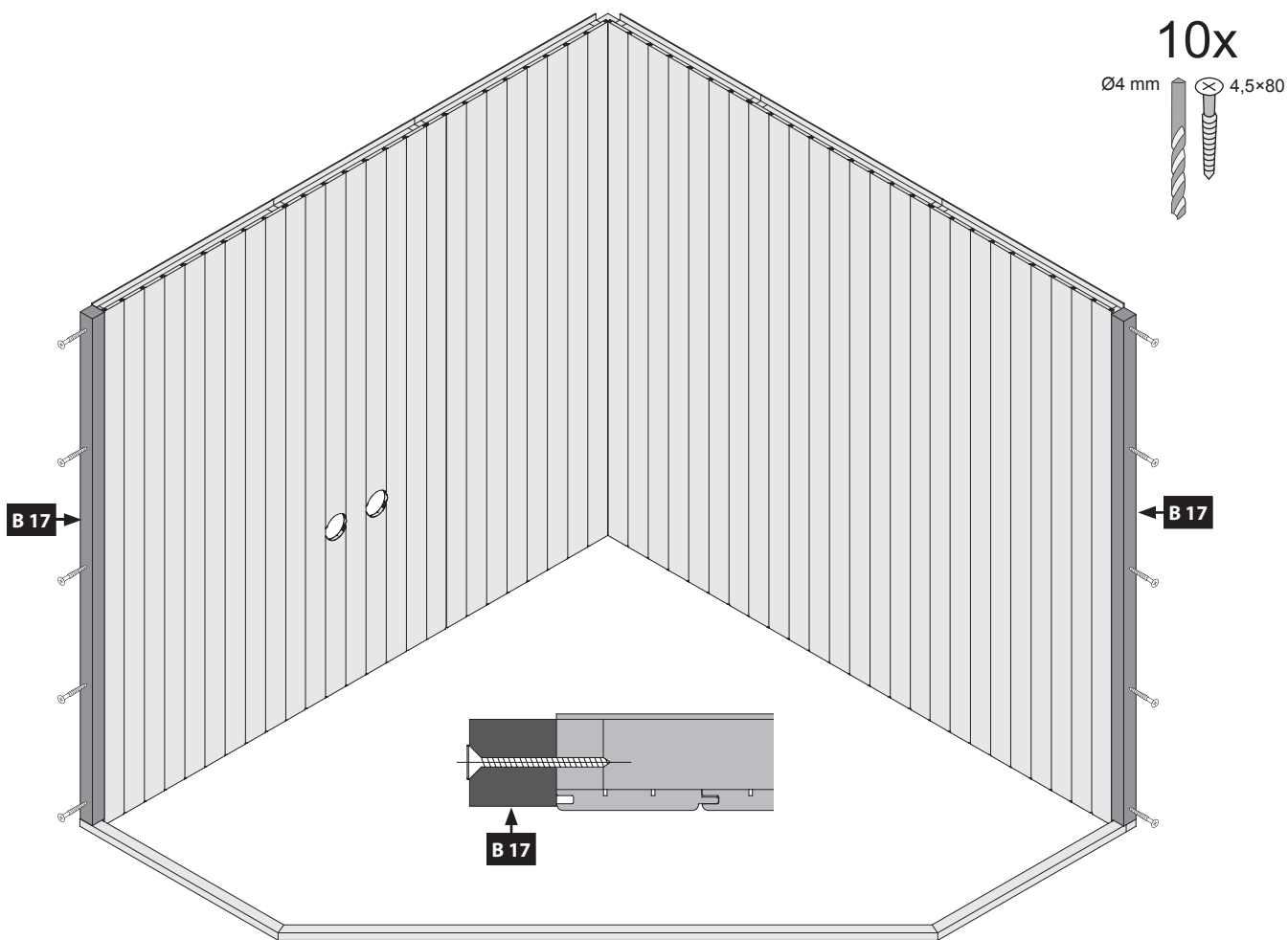
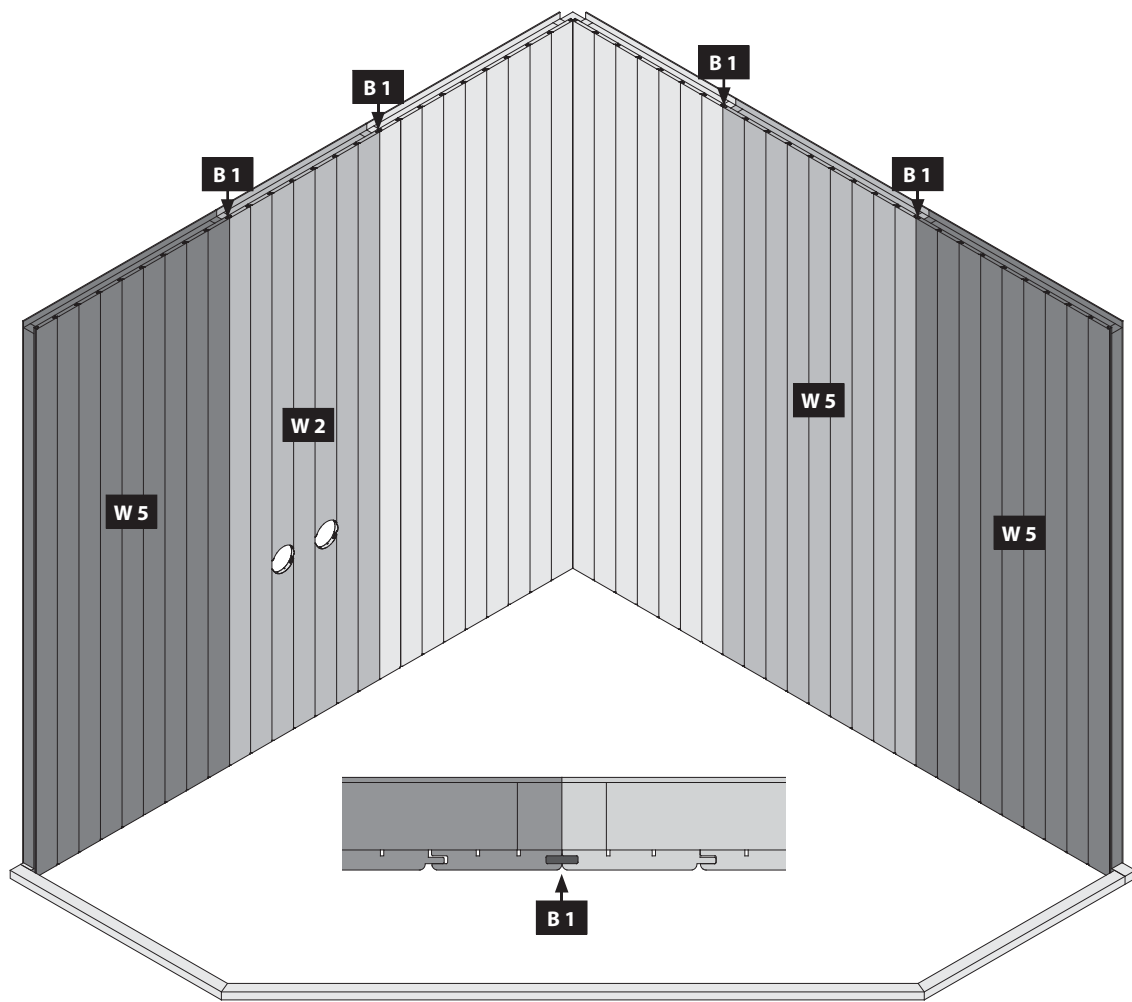

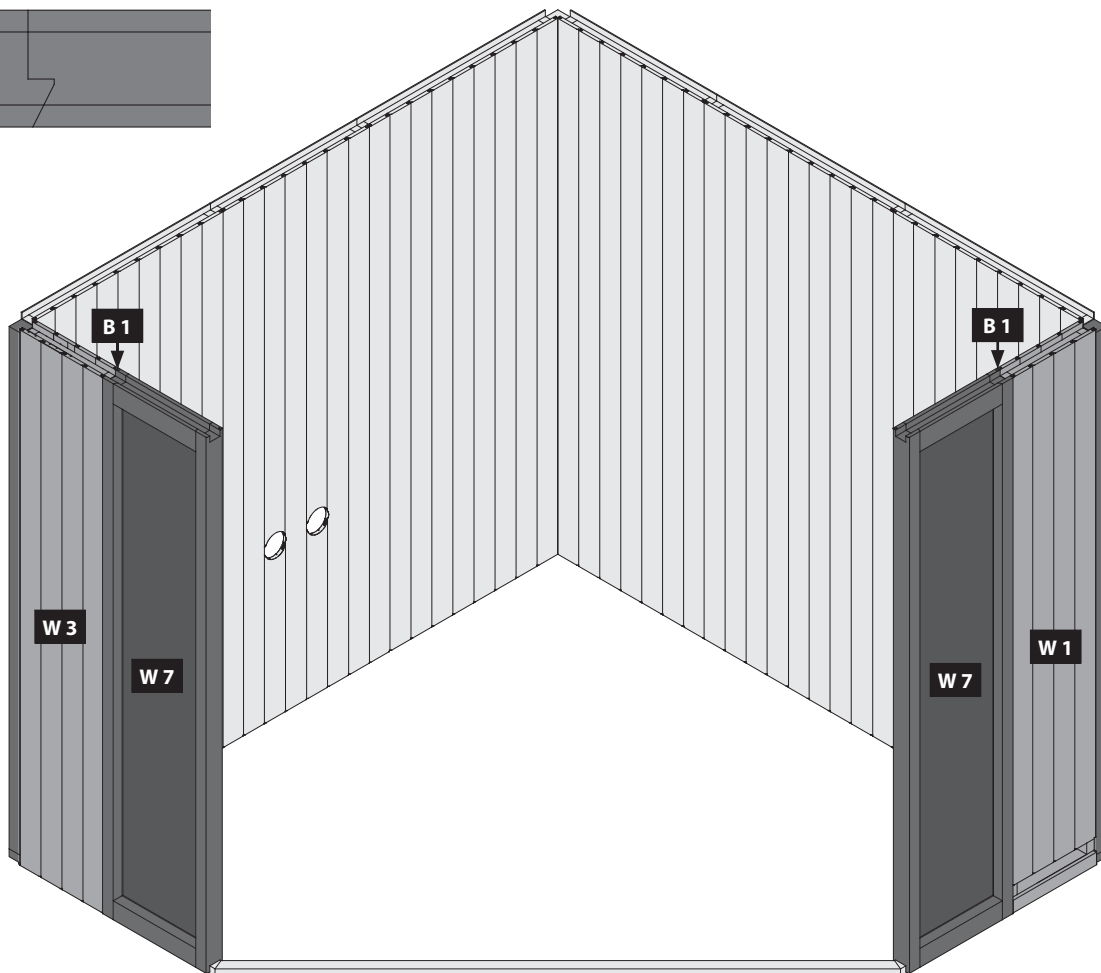
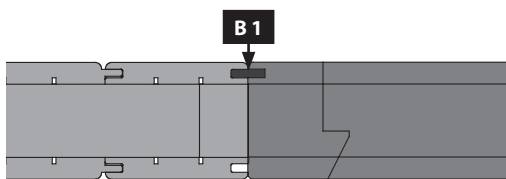
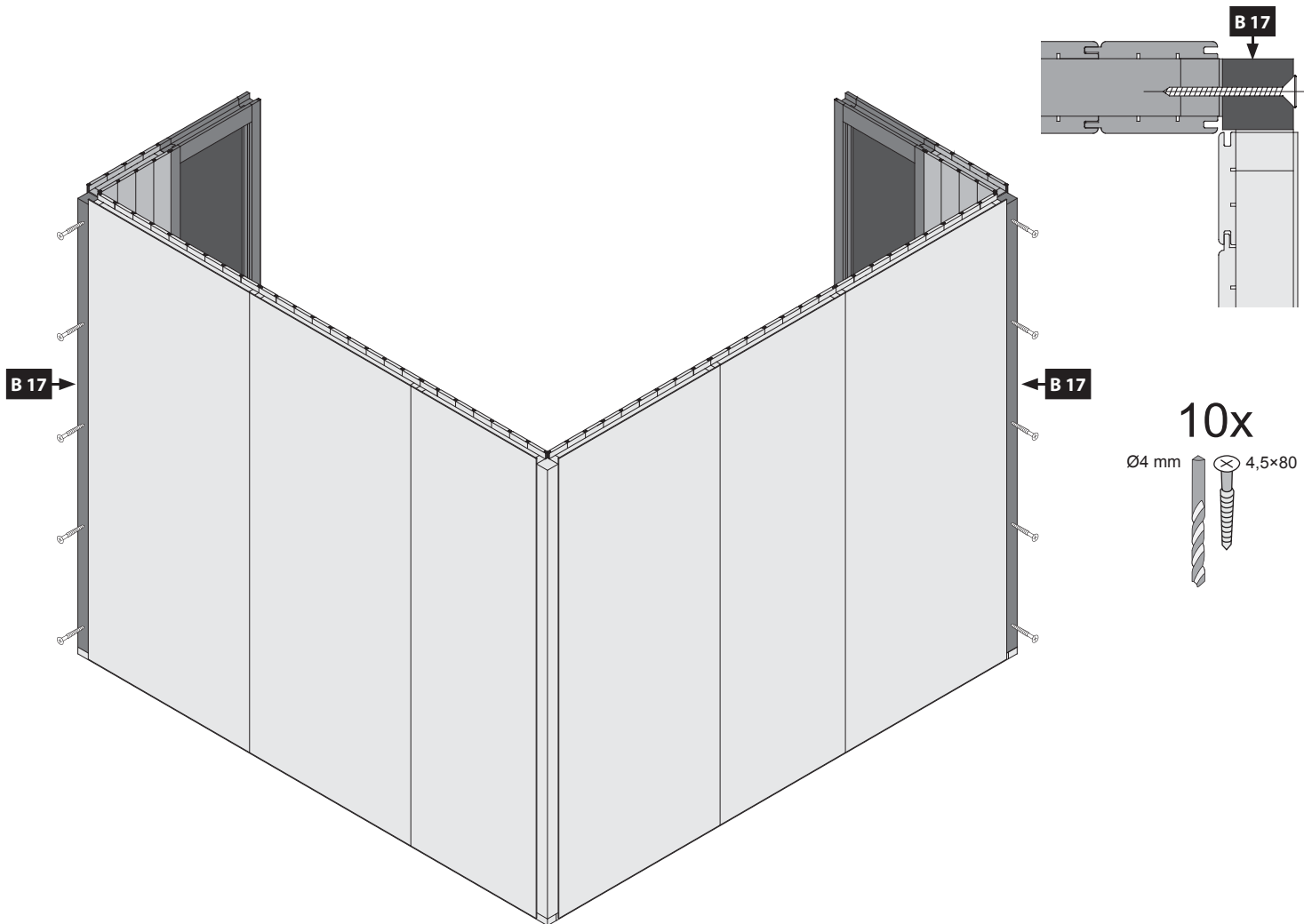

 Kabeldurchführung

 cable inlet

 entrée de câble

 kabel implementering





 kabelingang



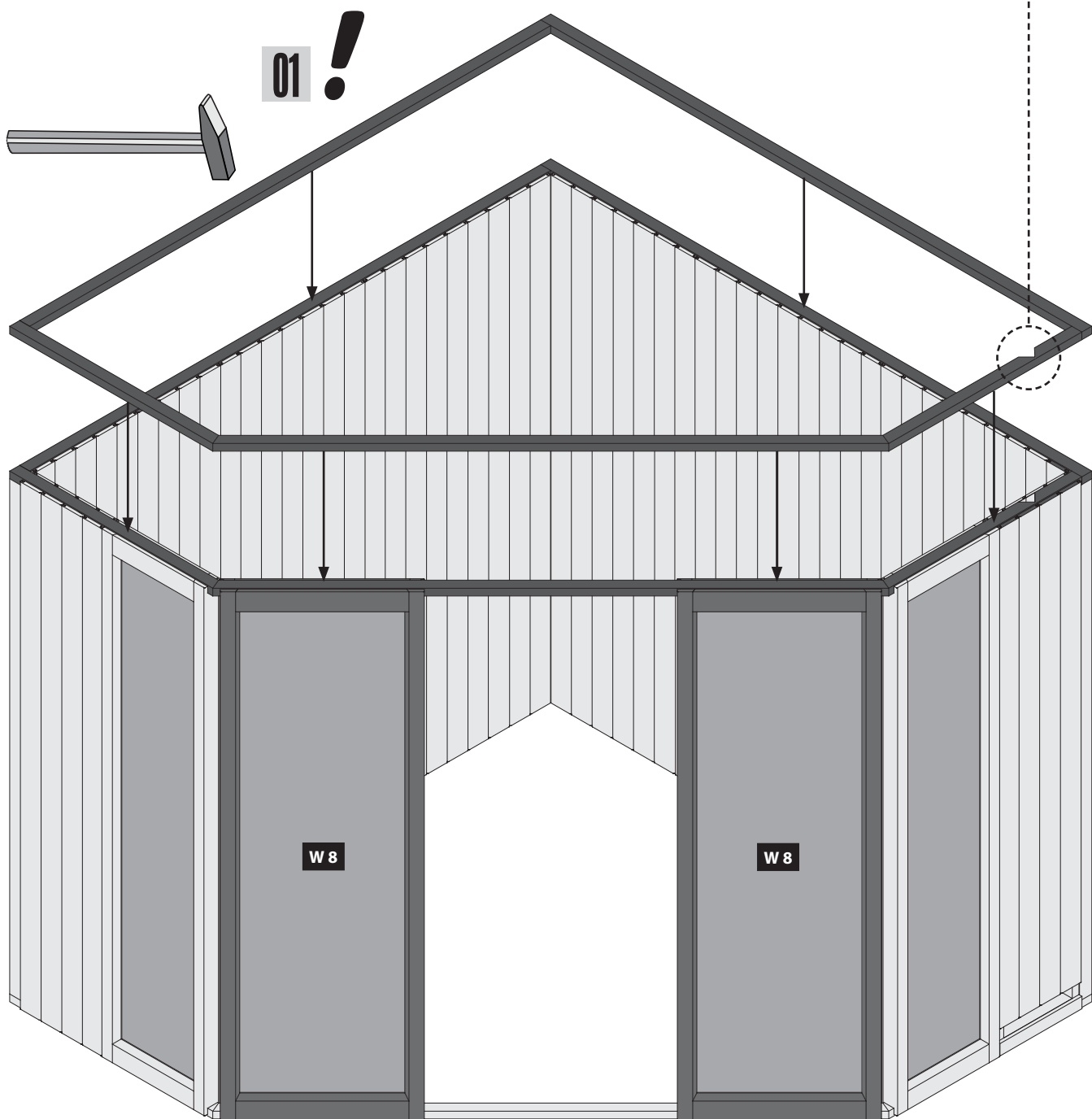
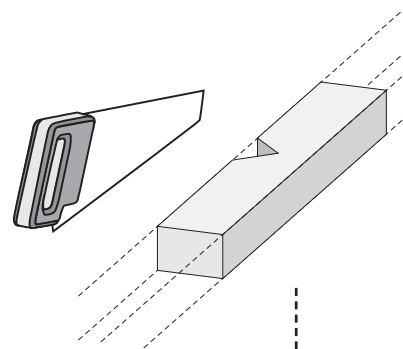

 entrada del cable

 ingresso cavi

 kabelová průchodka



-  Einbau Glastür
-  Installation of glass door
-  Montage porte en verre
-  Montage van de glazen deur

-  Installationsglasdør
-  Montaje de la puerta de cristal
-  Installazione portello di vetro
-  Sauna Instalace dveře

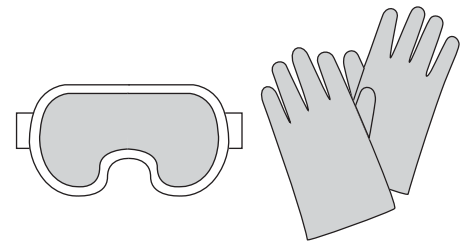

07

-  Saunatürglas in den Türrahmen legen
-  Put the door glass in the frame
-  Mettez le verre de la porte dans le cadre
-  Plaats het deurglas in het frame
-  Sæt dørglasset i rammen
-  Pon el vidrio de la puerta en el marco
-  Metti il vetro della porta nel telaio
-  Vložte sklo dveří do rámu

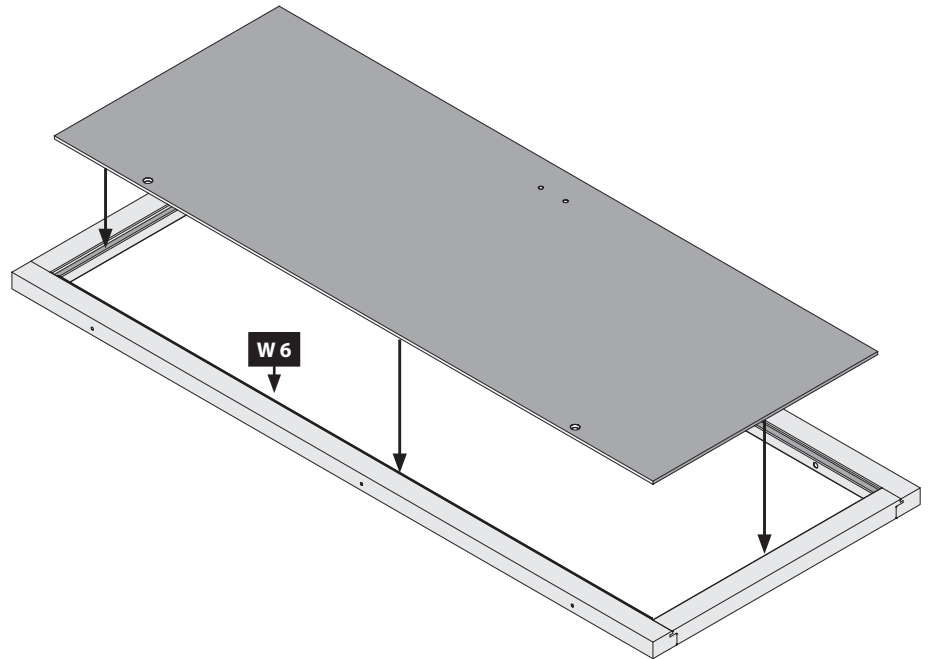

-  Saunatürglas in den Türrahmen ausrichten
-  Center the glass in the wooden frame
-  Bien aligner le verre à vitre
-  Lijn het glas uit in het deurframe
-  Juster saunaens dørglas i dørkarmen
-  Alinee el vidrio en el marco de la puerta
-  Allineare il vetro nel telaio della porta
-  Skleněná dvířka sauna v zárubně zarovnáni

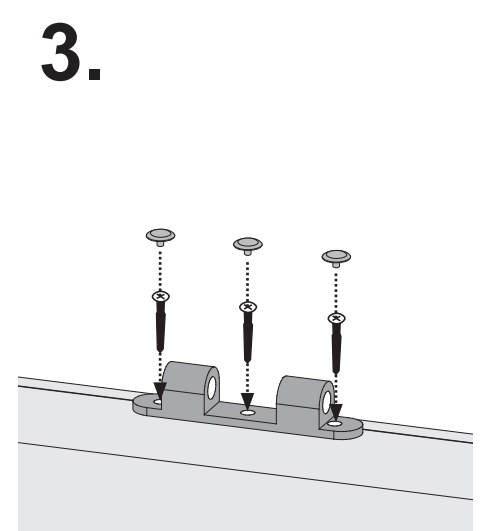
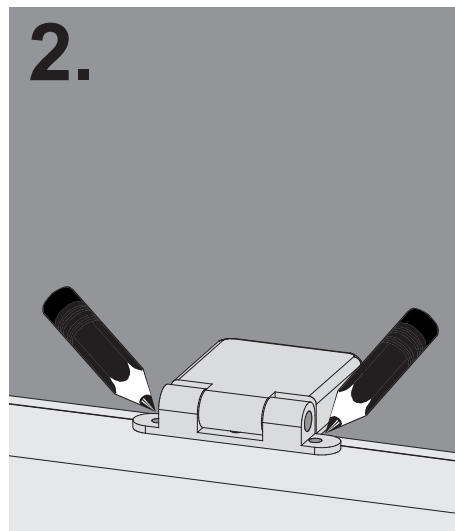
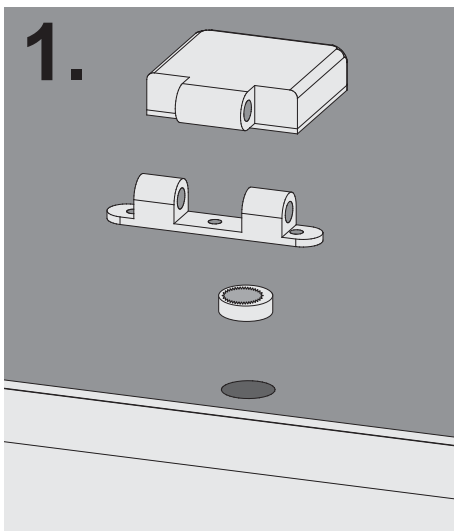
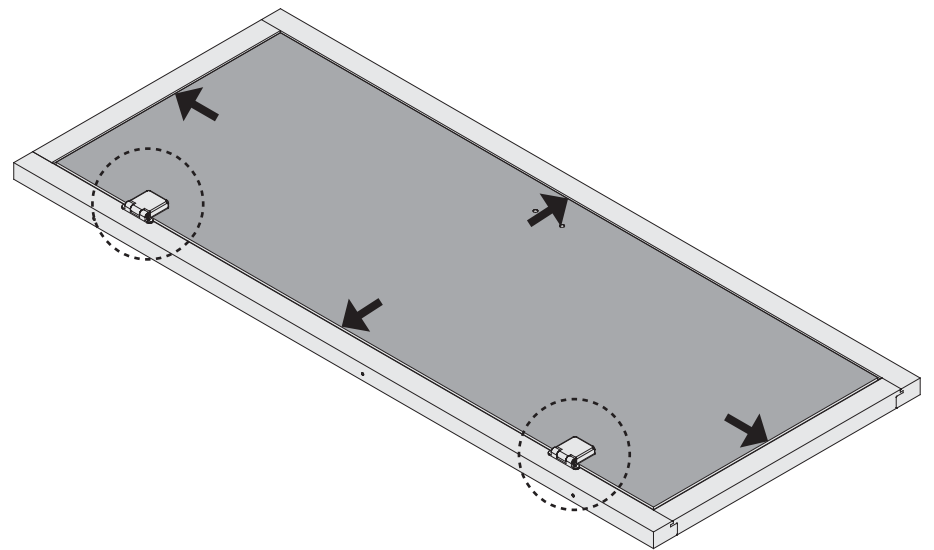

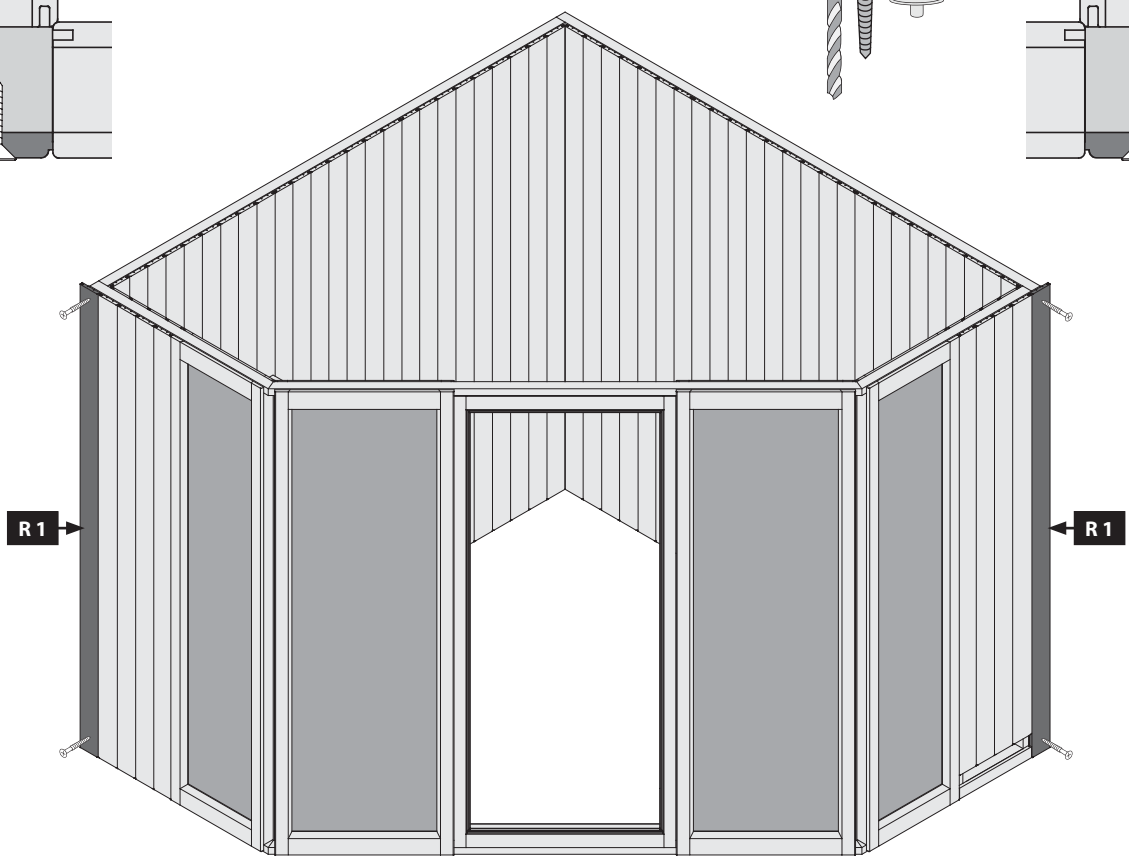
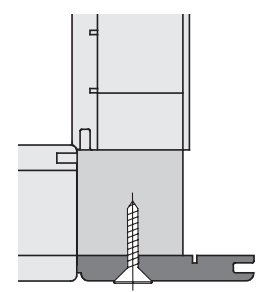
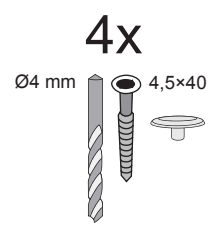
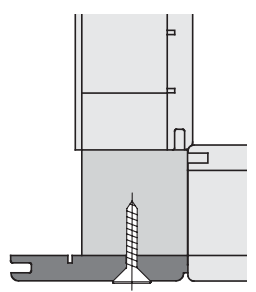
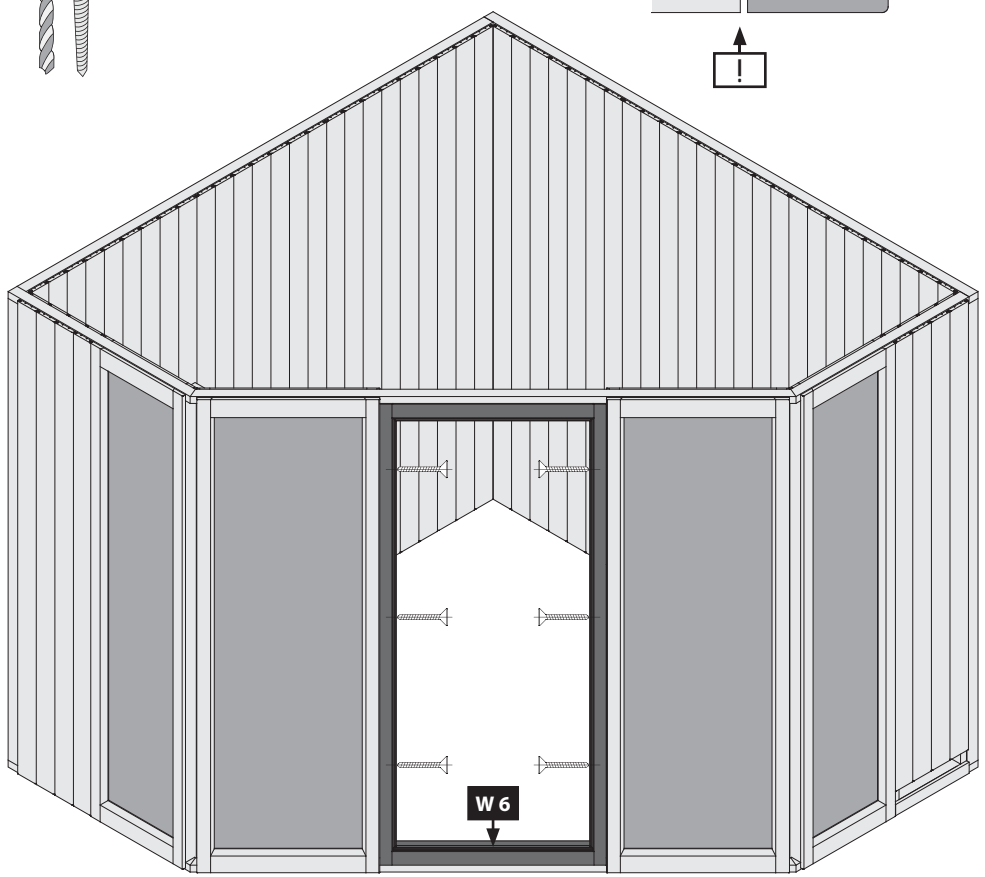
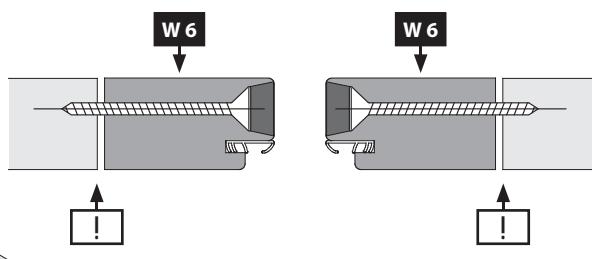
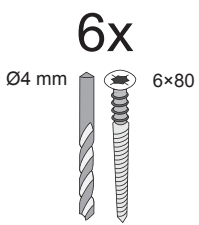

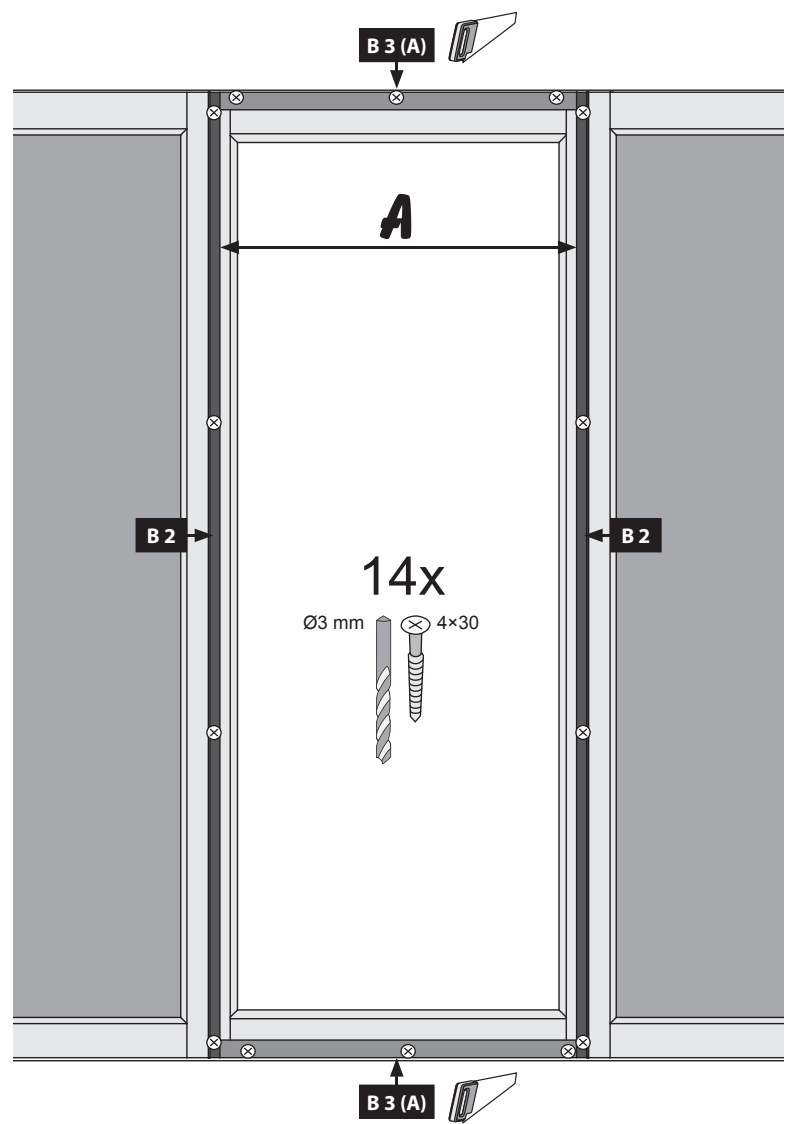
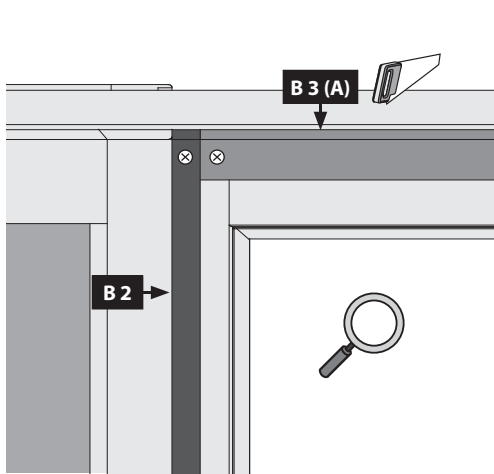
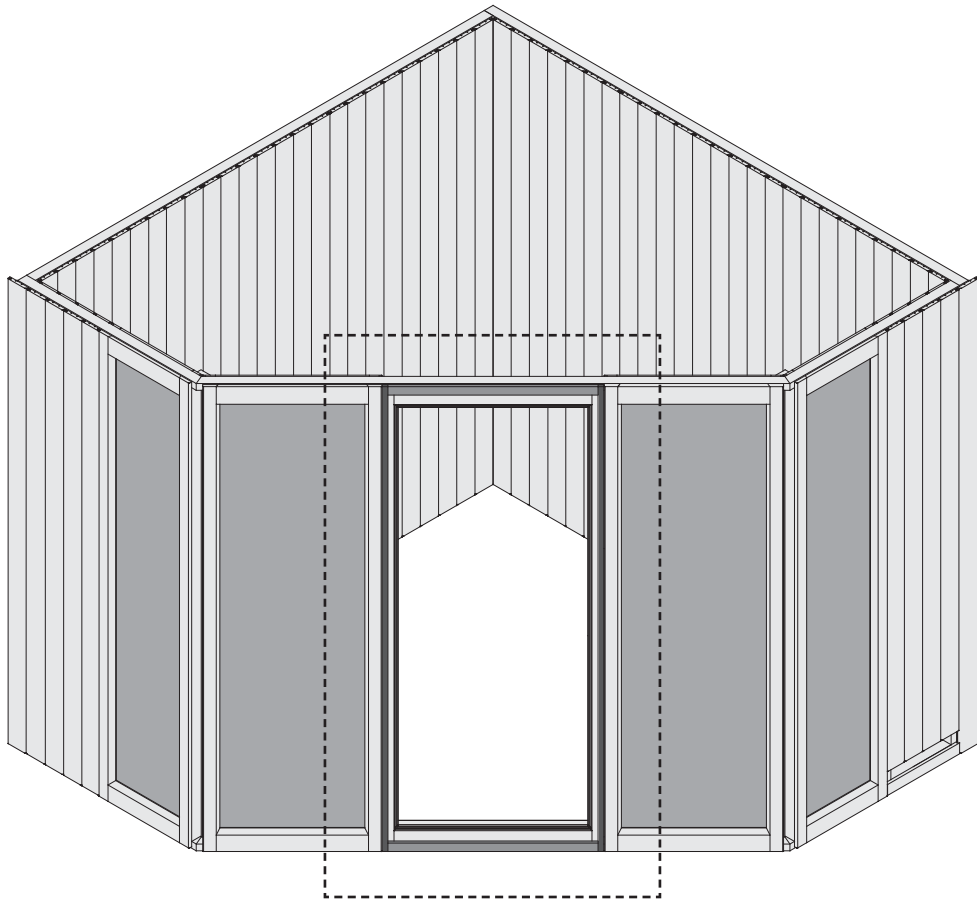

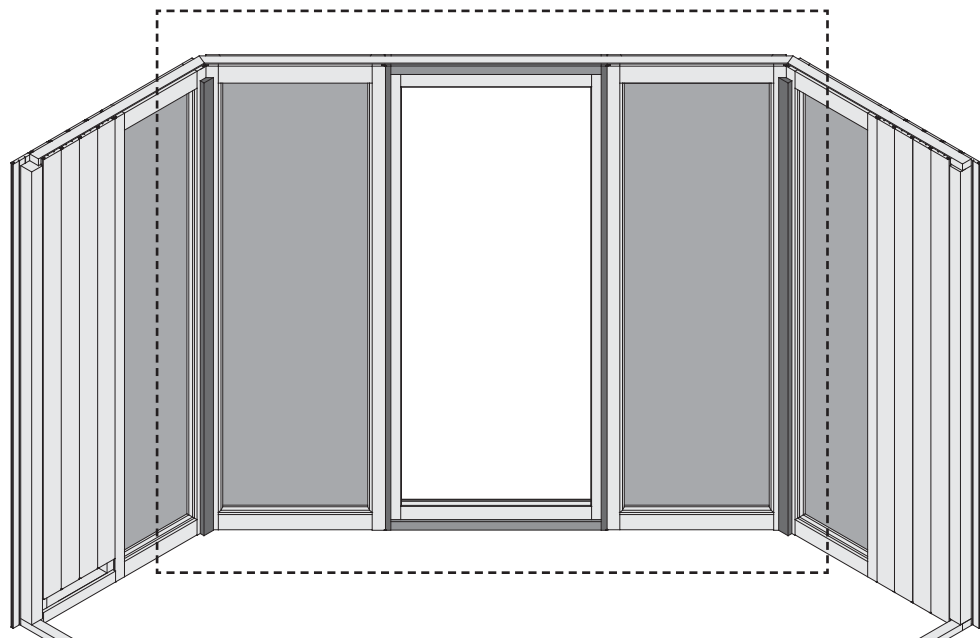

-  innen
-  Inside
-  à l'intérieur
-  binnen
-  dentro
-  dentro
-  uvnitř

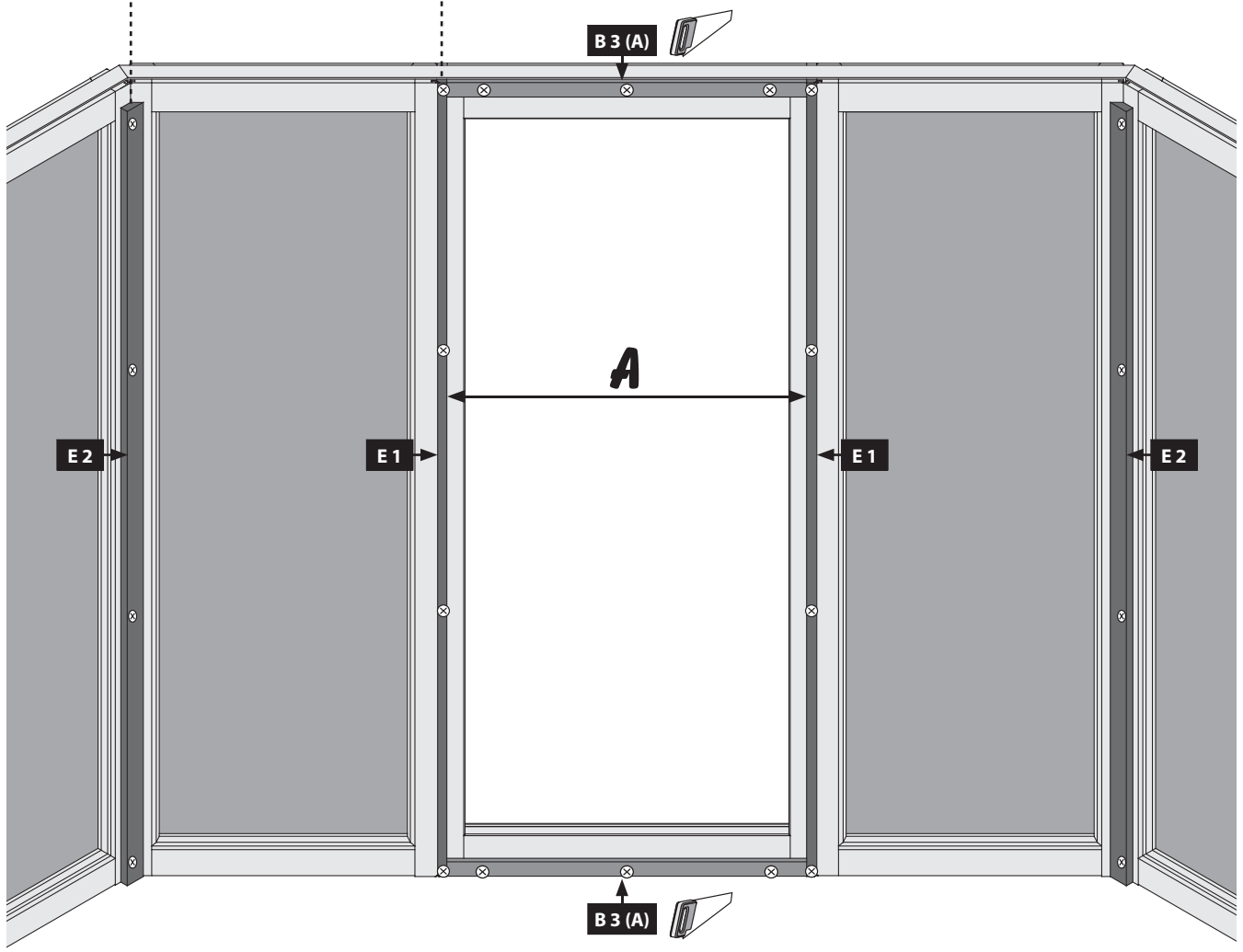
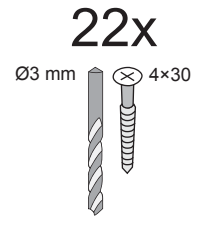
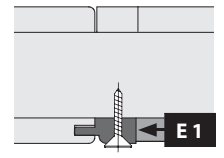
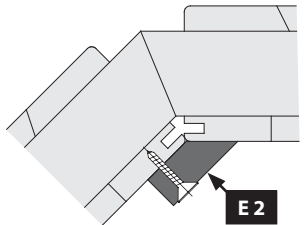

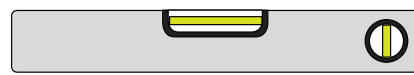

21x

Ø3 mm 4x50

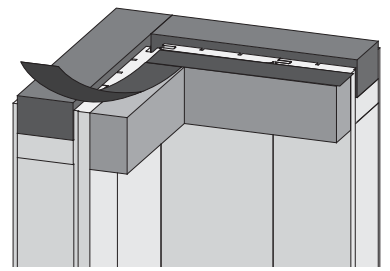
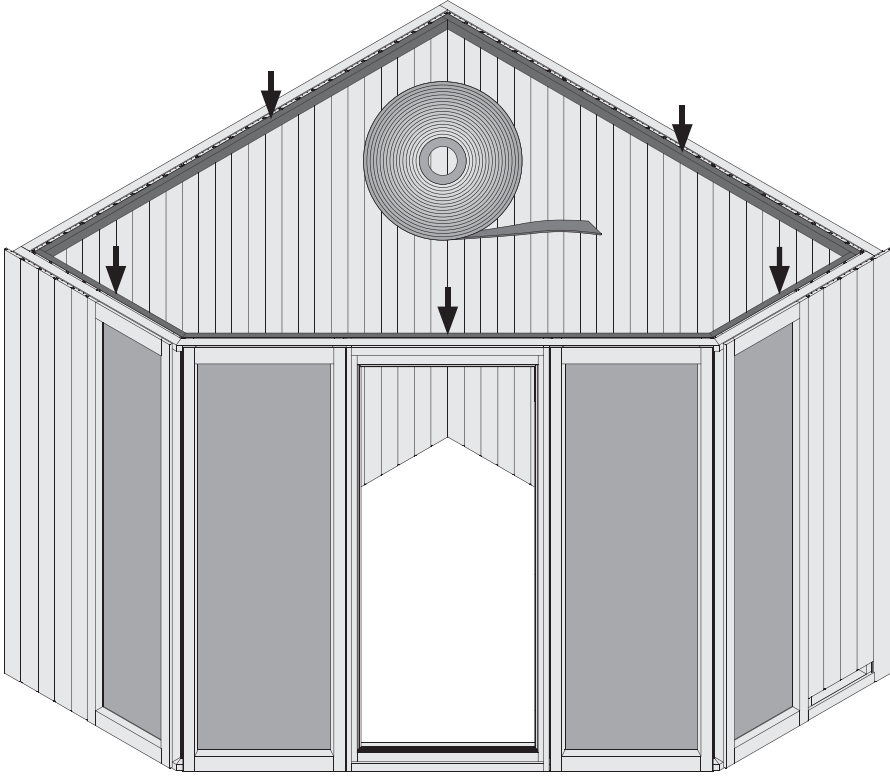
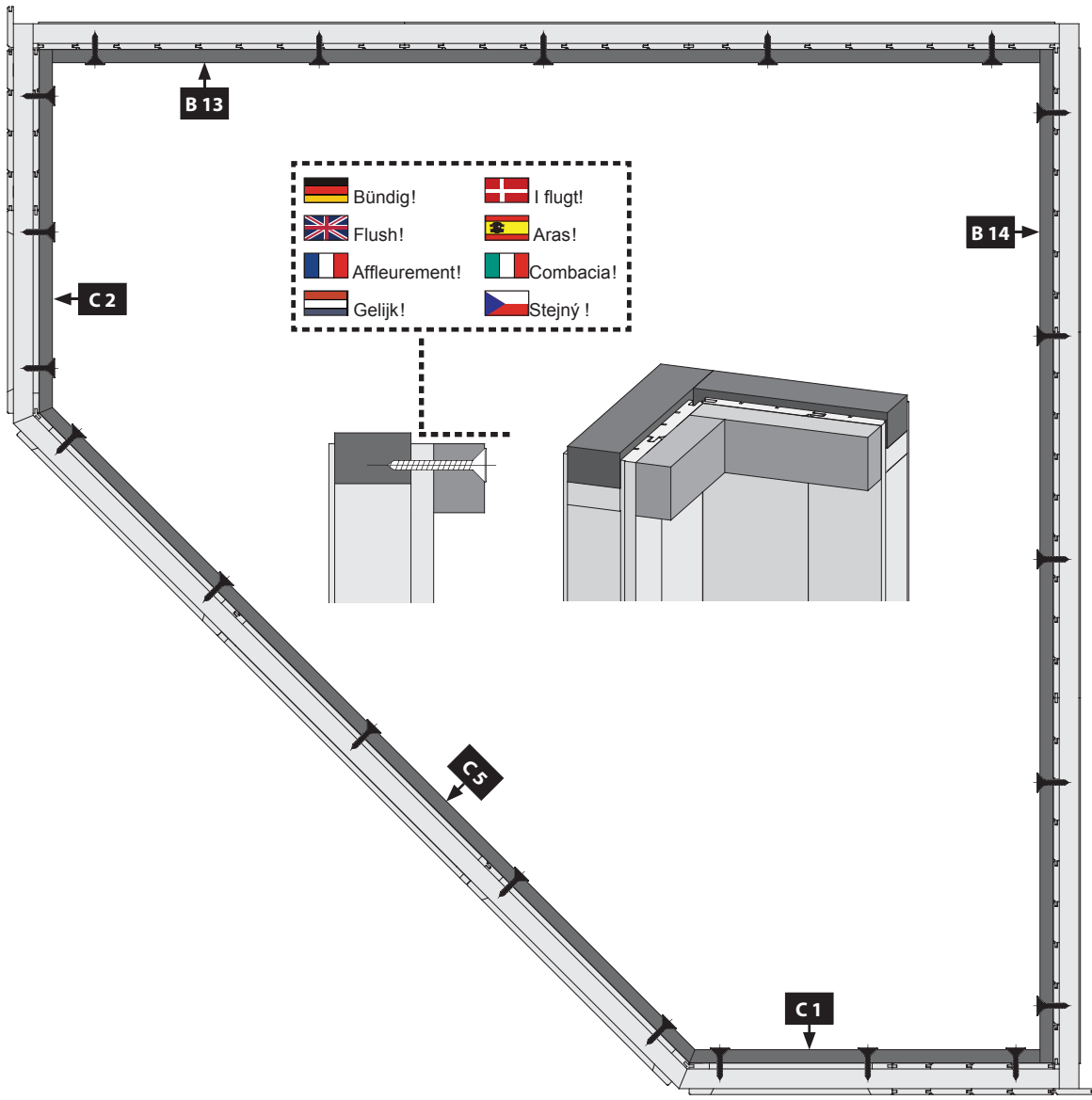
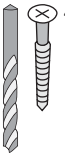

-  Sauna Dichtband
-  Sauna sealing tape
-  Ruban d'étanchéité pour sauna
-  Sauna tætningsbånd
-  Sauna afdichtingstape
-  Cinta de sellado de sauna
-  Nastro sigillante per sauna
-  Sauna těsnící páska

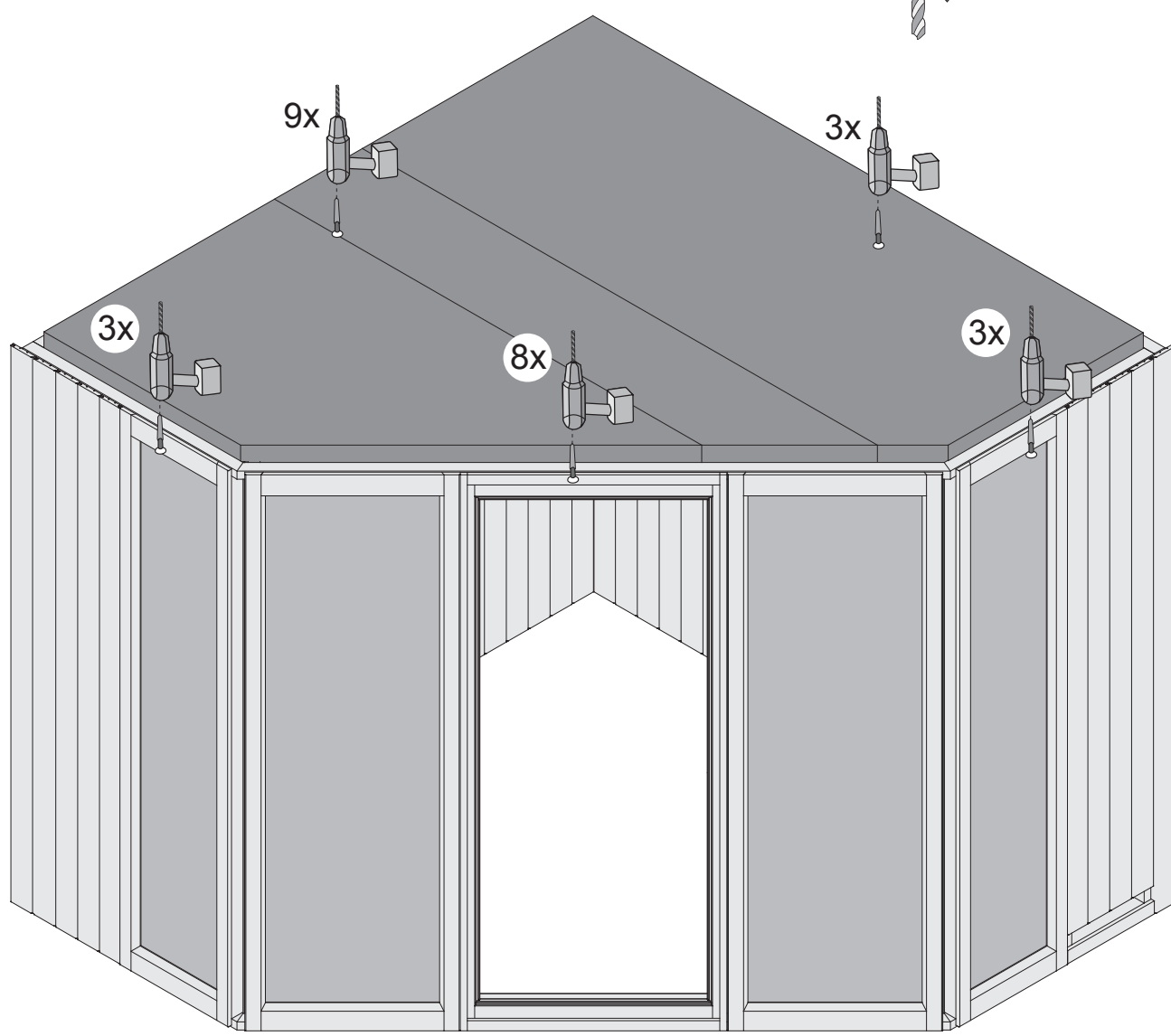
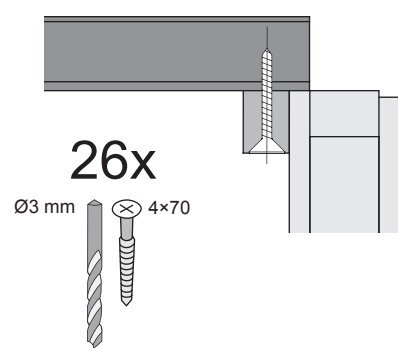
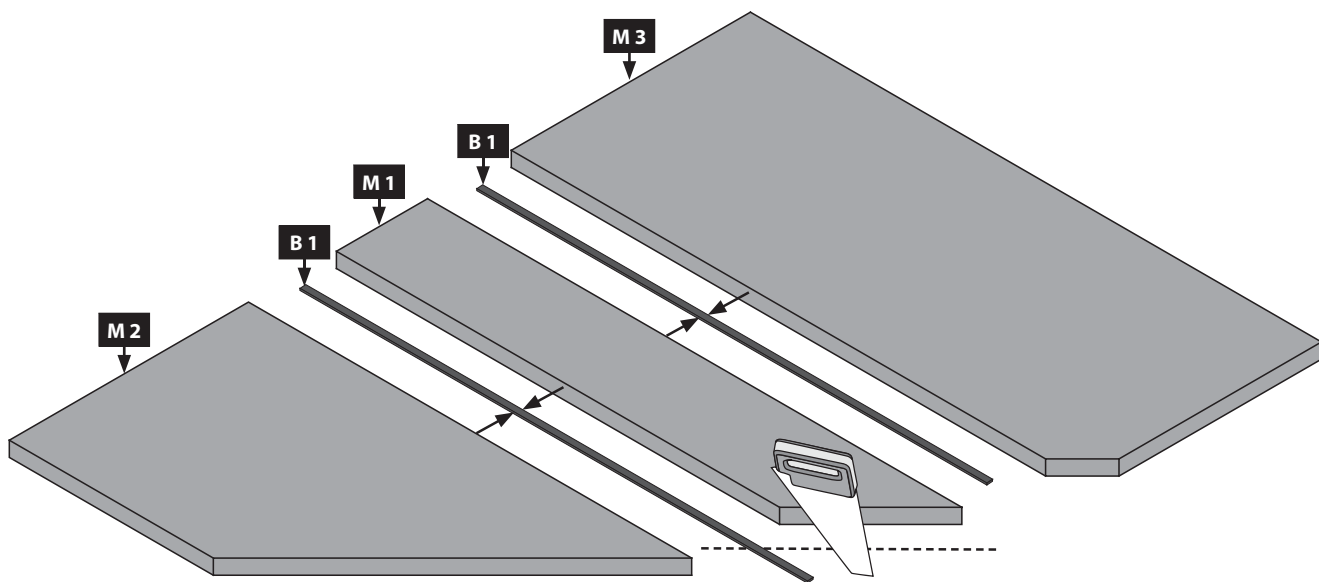





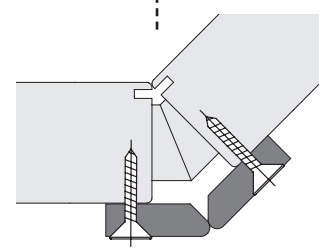
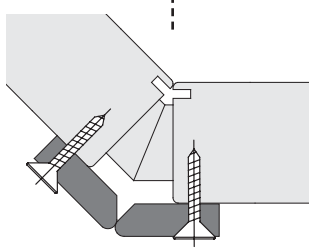
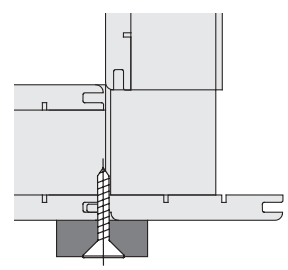
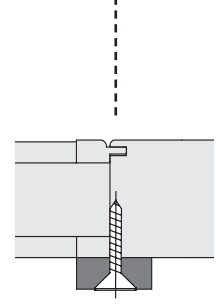
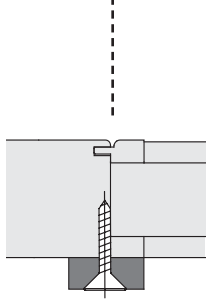
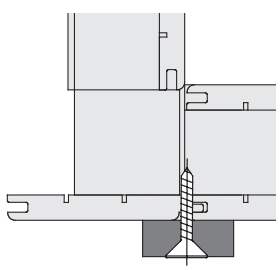
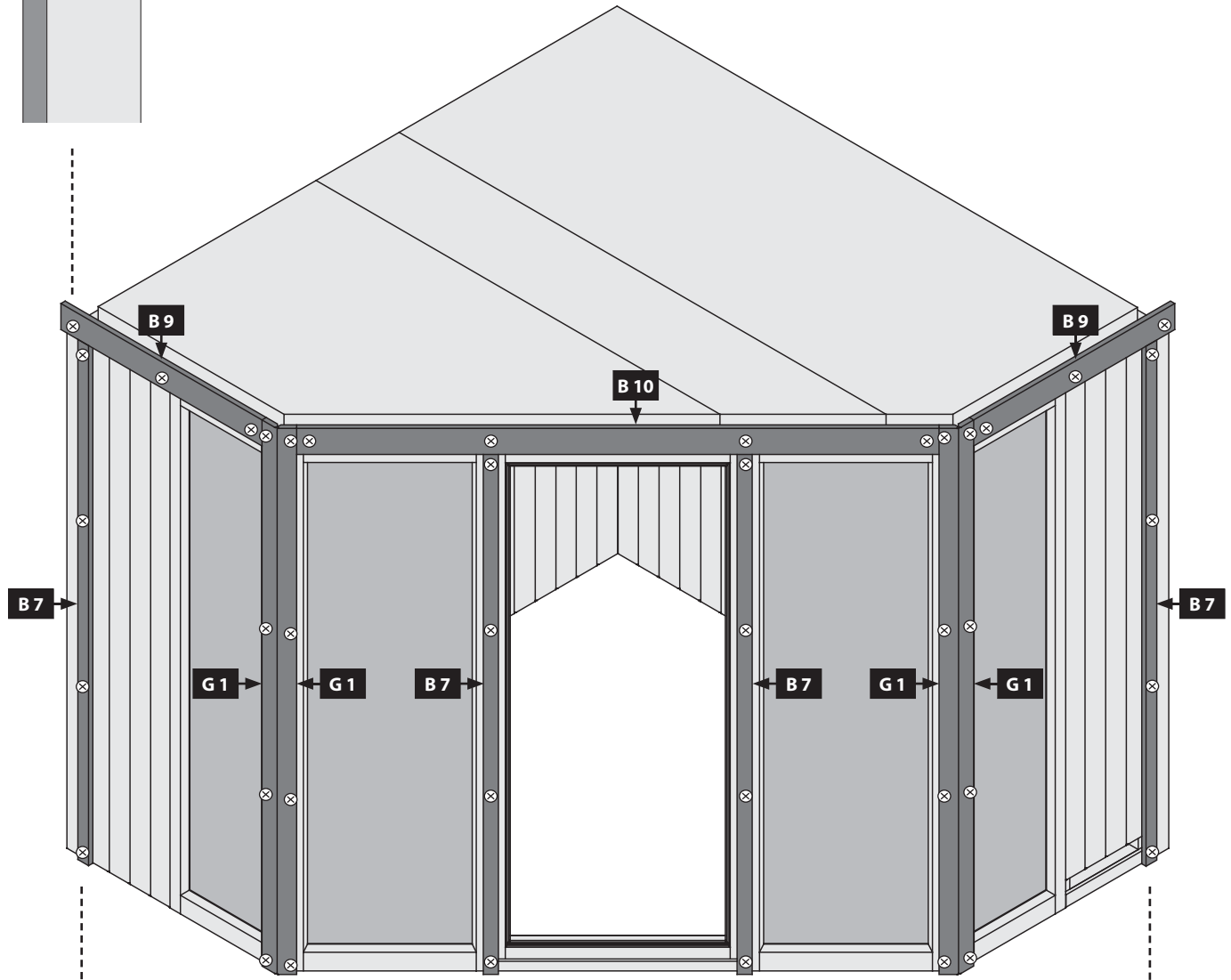
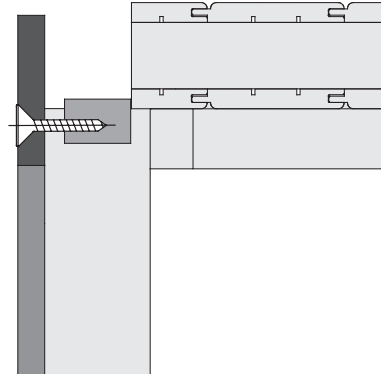

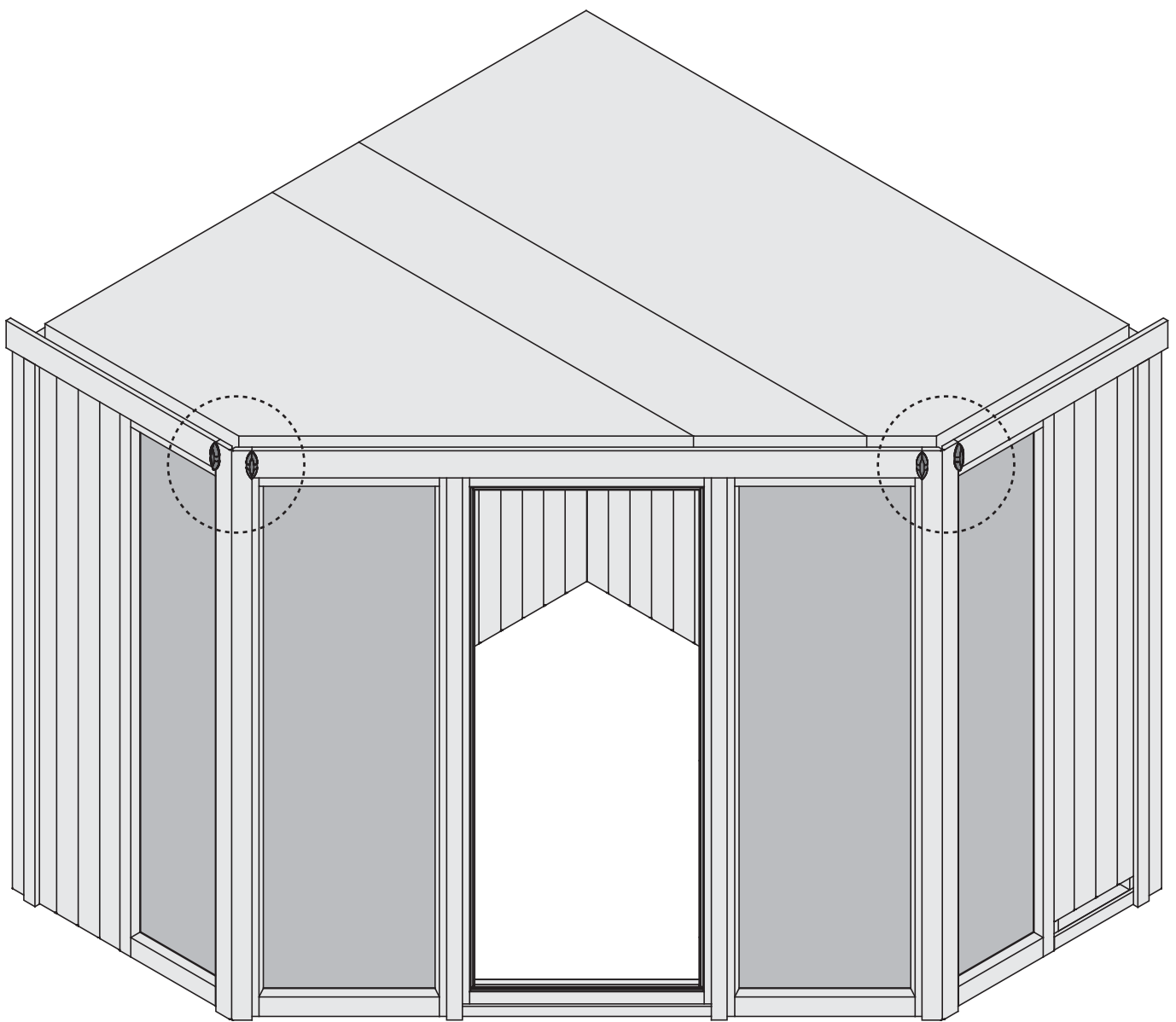
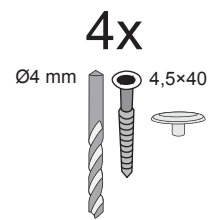
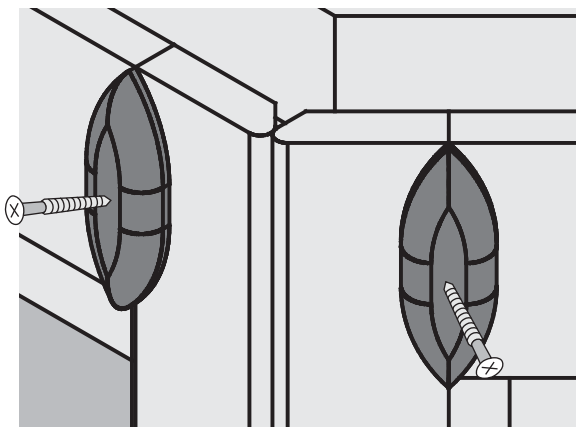

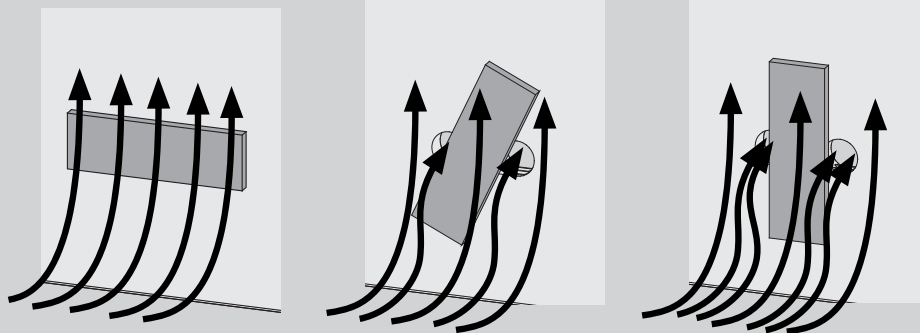
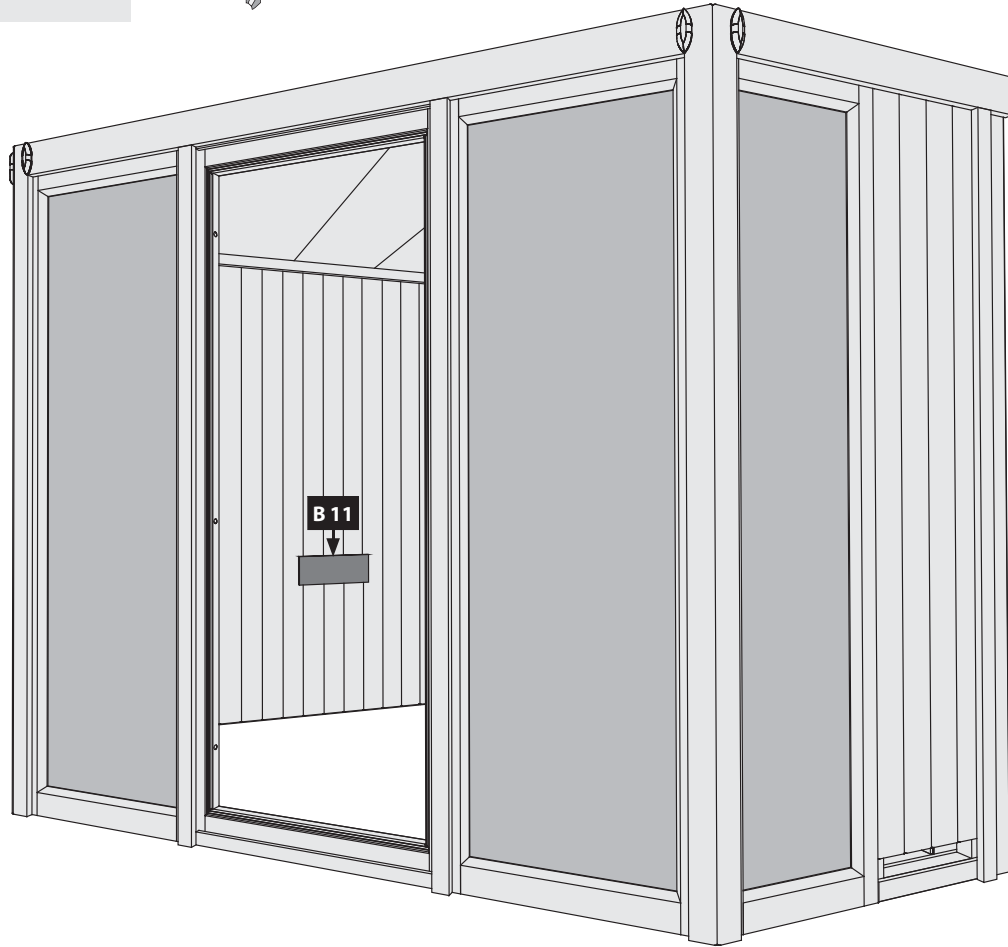
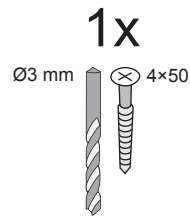
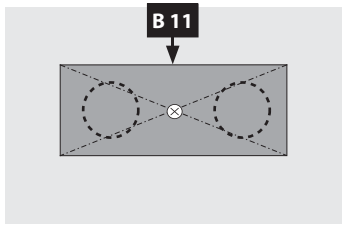

42x
Ø4 mm 4,5x40







-  Hier ist die Funktionsweise des Brettes abgebildet. Regeln Sie damit die Abluft nach Ihren eigenen Wünschen
-  This figure shows the functional principle of the board. Regulate the exhaust air according to your own wishes
-  Ceci représente le mode de fonctionnement de la planche. Avec elle, réglez l'écoulement de l'air selon vos désirs
-  Hier is de werking van het plankje afgebeeld. Regel daarmee de luchtafvoer naar eigen wens
-  Sådán fungerer styret. Brug den til at regulere udstødningsluften efter dine egne ønsker
-  Aquí está representada la forma de funcionamiento de la tabla. Regule con ello el aire de salida según sus propios deseos
-  Viene illustrato il principio di funzionamento della tavoletta di regolazione della ventilazione. Con essa si può regolare a piacere la ventilazione
-  Zde je zobrazená funkce desky. Regulujte s ní odsávací vzduch dle Vašeho přání

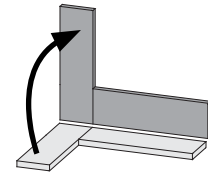
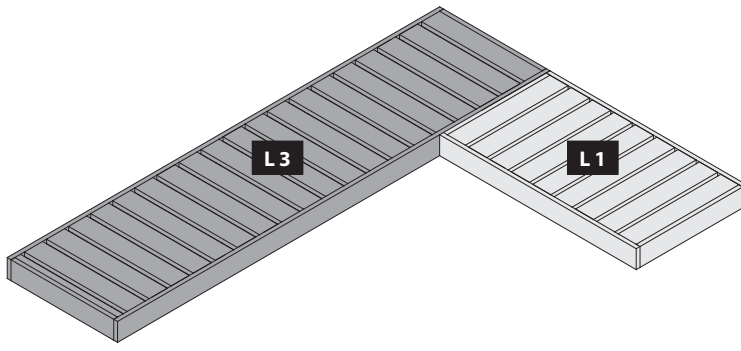

17

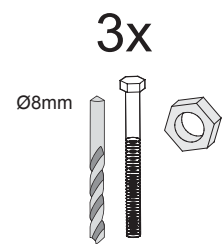
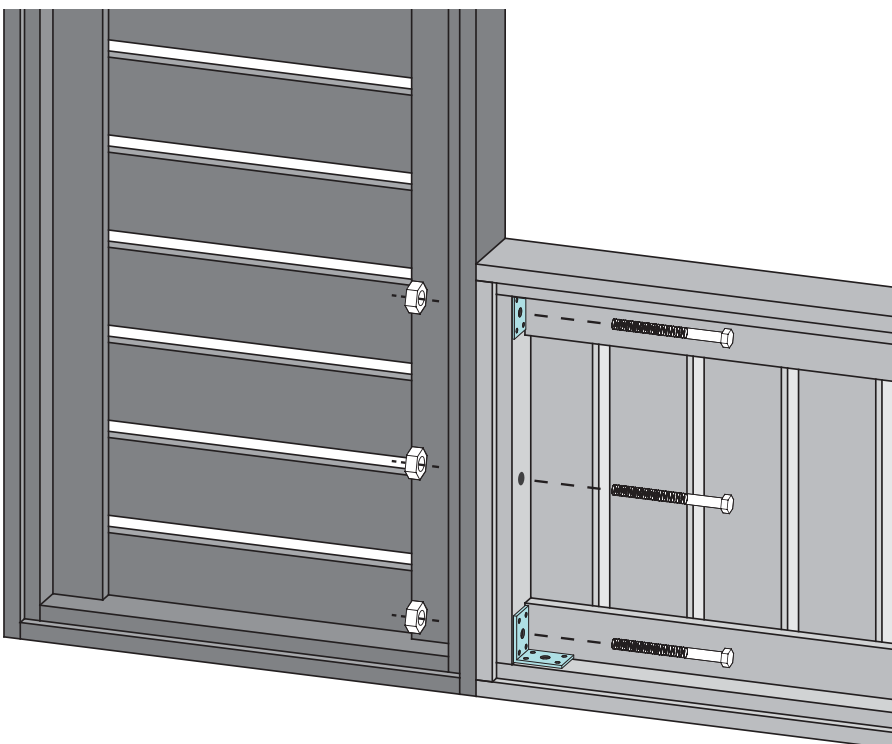
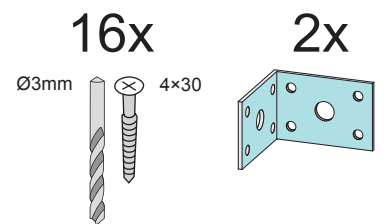
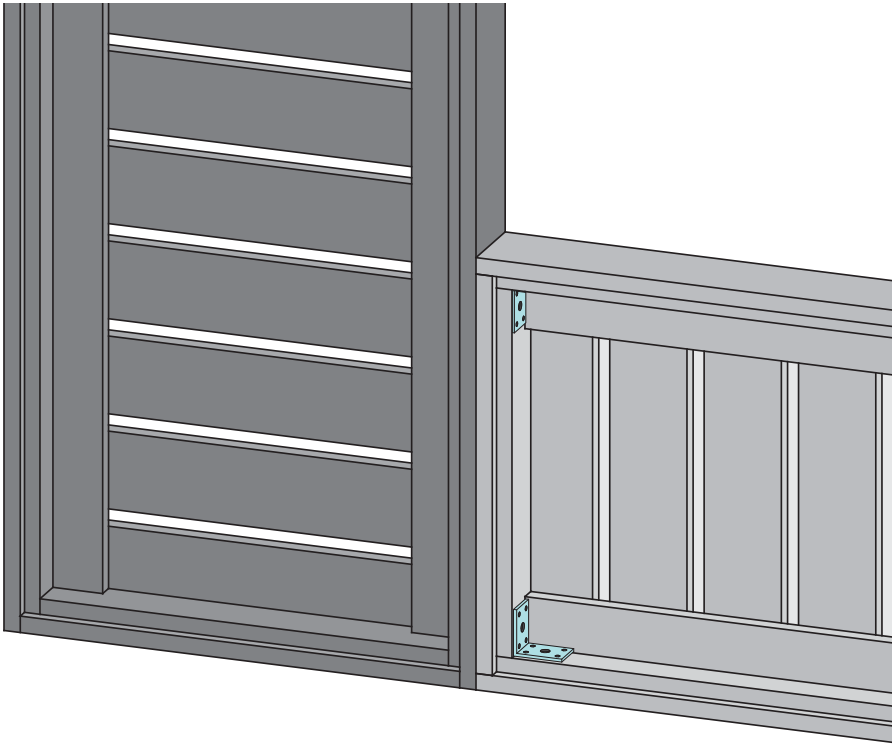

-  Ansicht unten
-  View below
-  Voir ci-dessous
-  Bekijk hieronder
-  Se nedenfor
-  Ver abajo
-  Visualizza sotto
-  Zobrazit níže

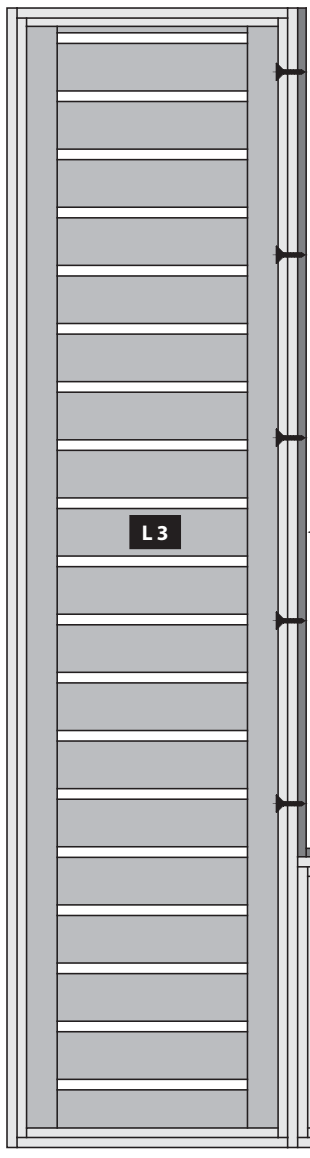
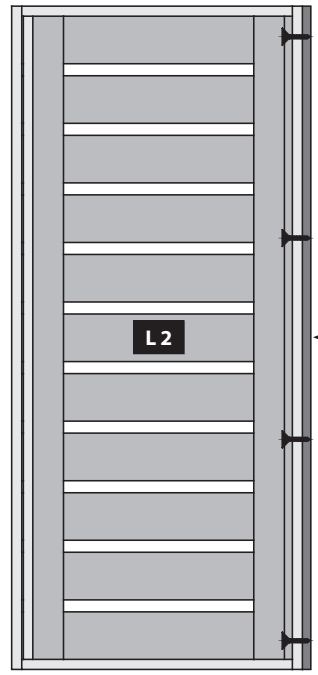

13x

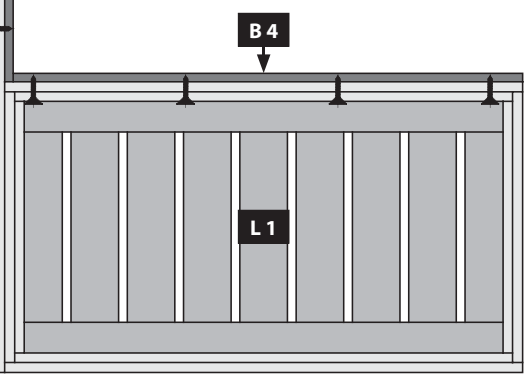
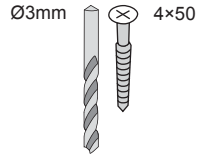

a





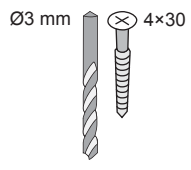



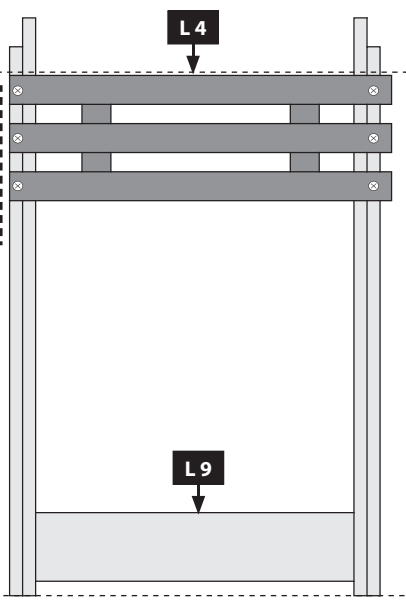
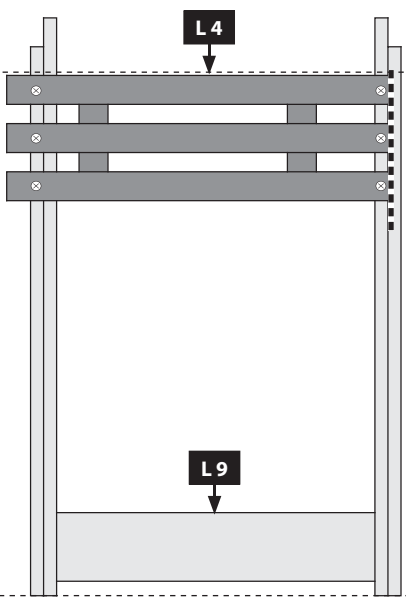

12x



b



-  Bündig!
-  Flush!
-  Affleurement!
-  Gelijk!
-  I flugt!
-  Aras!
-  Combacia!
-  Stejný !

815 mm

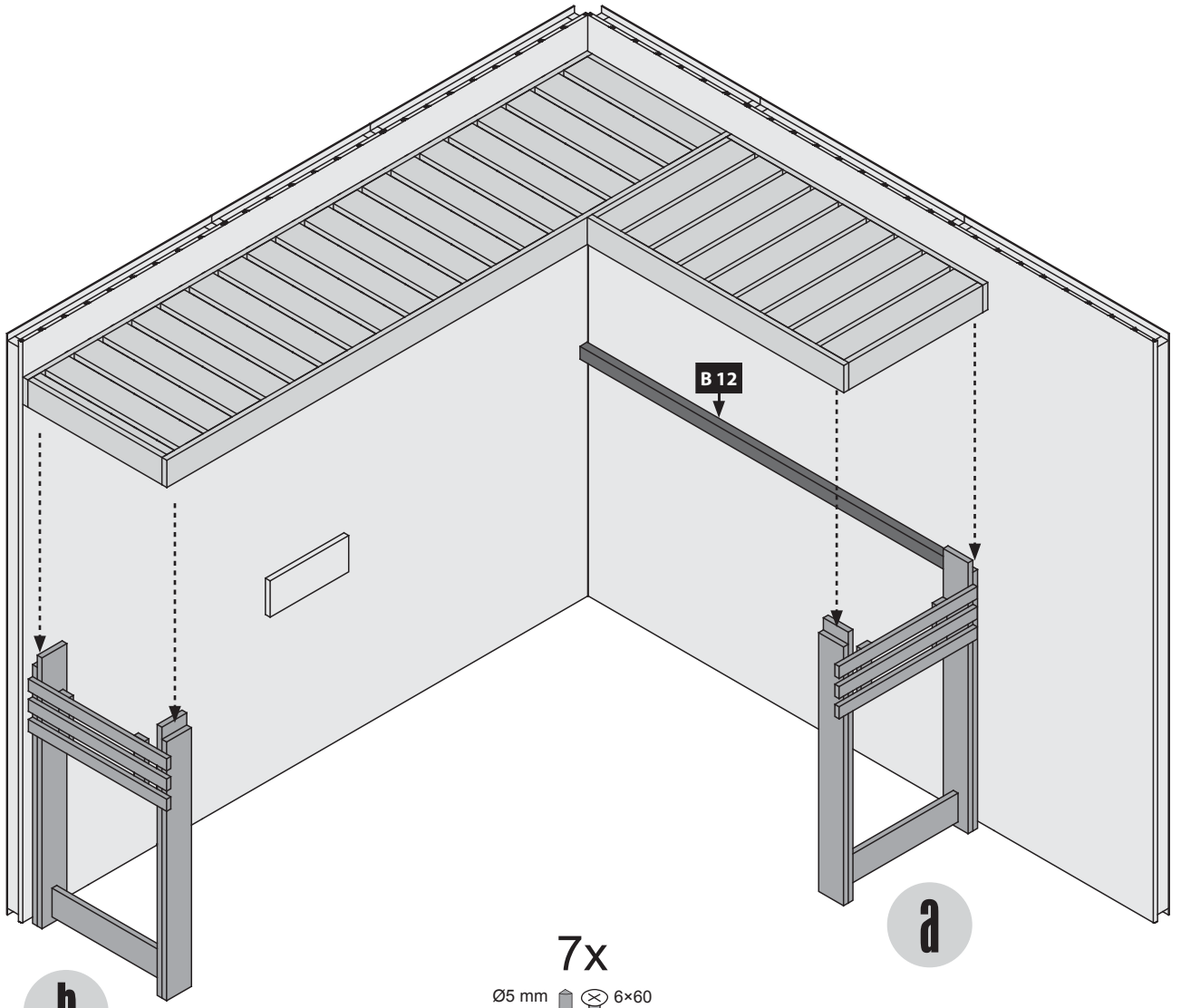

b

a

7x
Ø5 mm 6x60

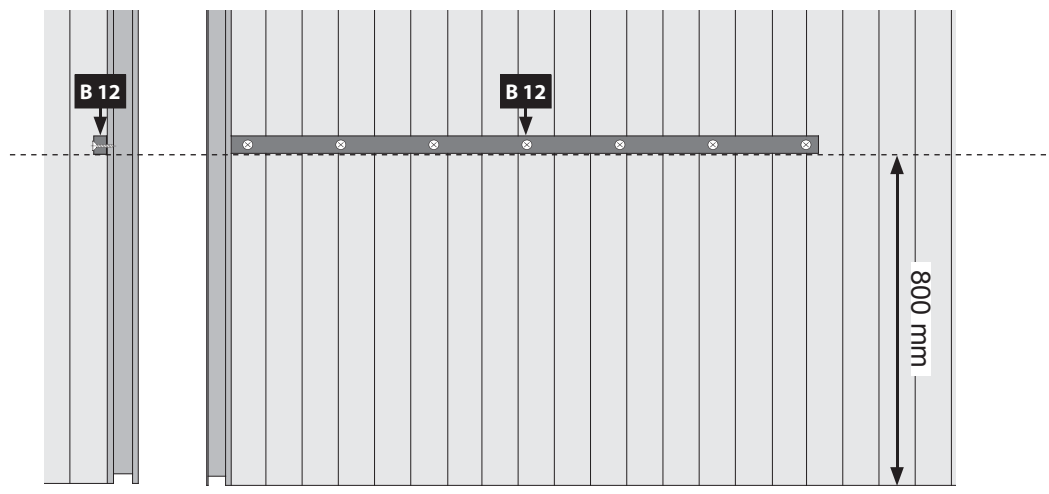

6x

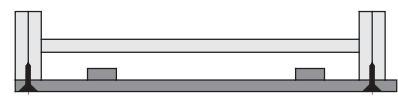
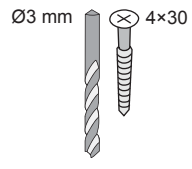

515 mm

- Bündig!
- Flush!
- Affleurement!
- Gelijk!
- I flugt!
- Aras!
- Combacia!
- Stejný !

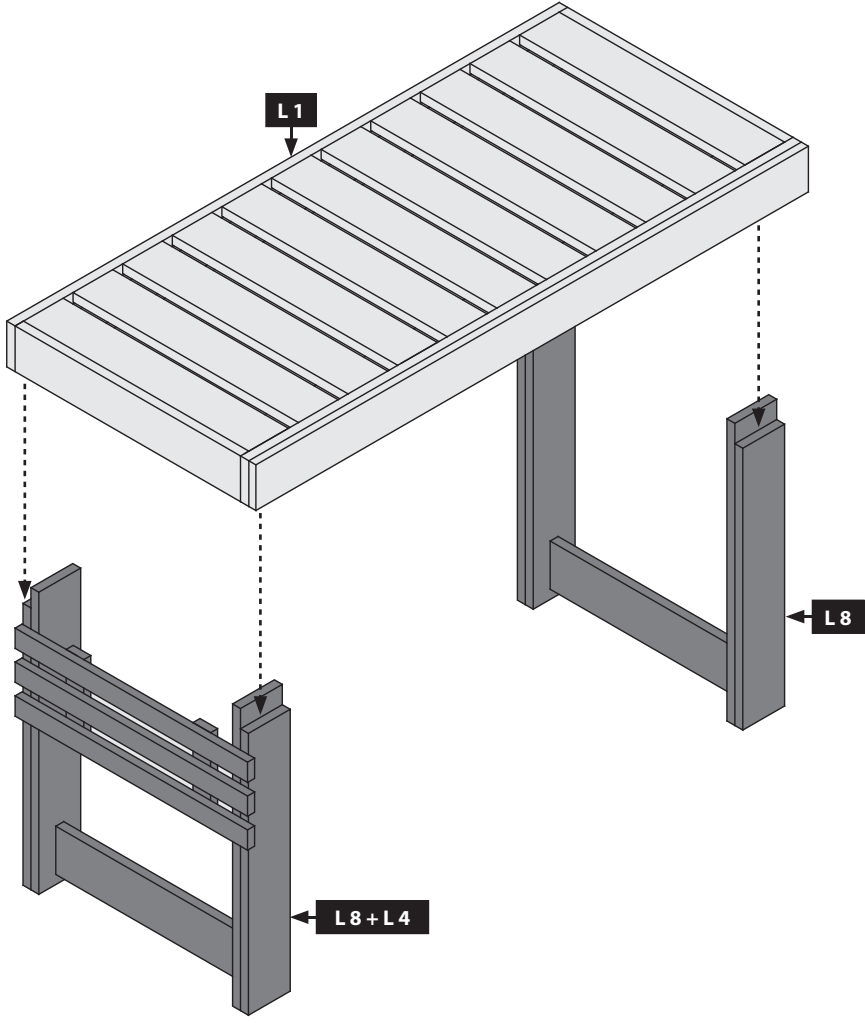
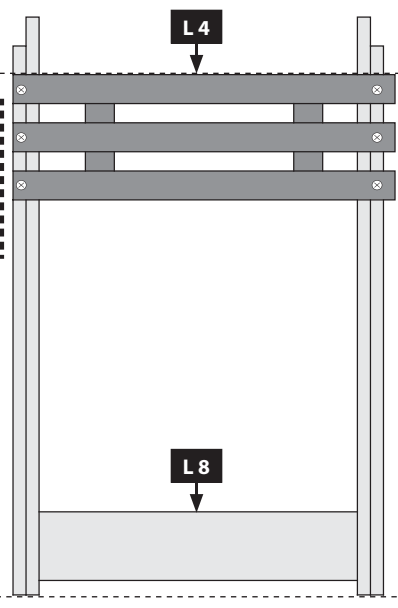

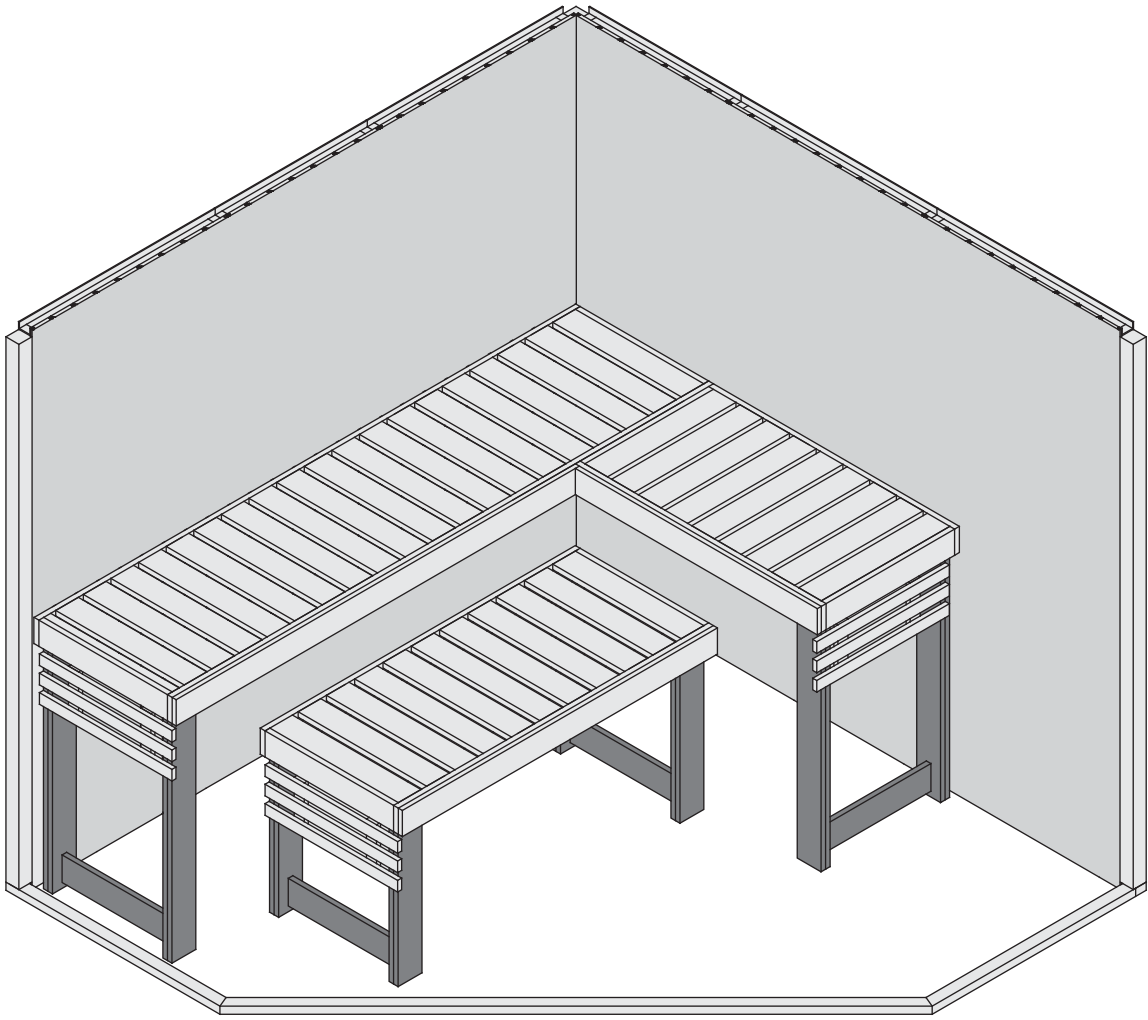

16x

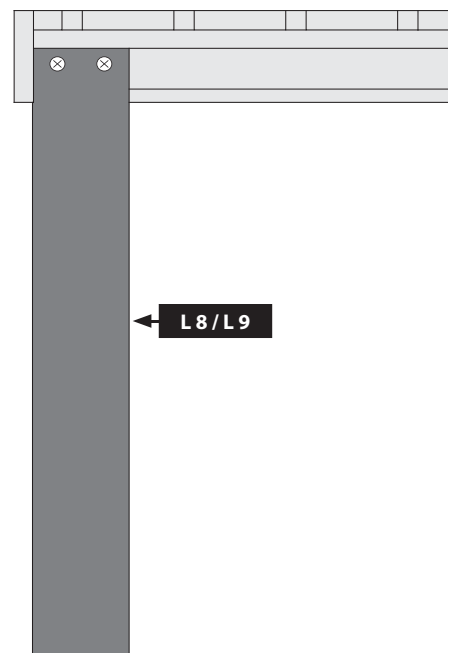
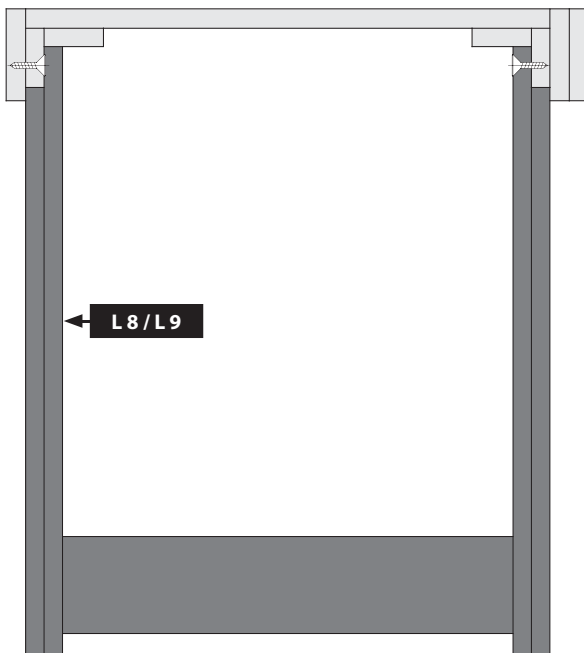
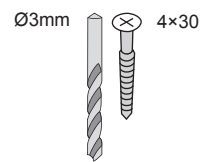

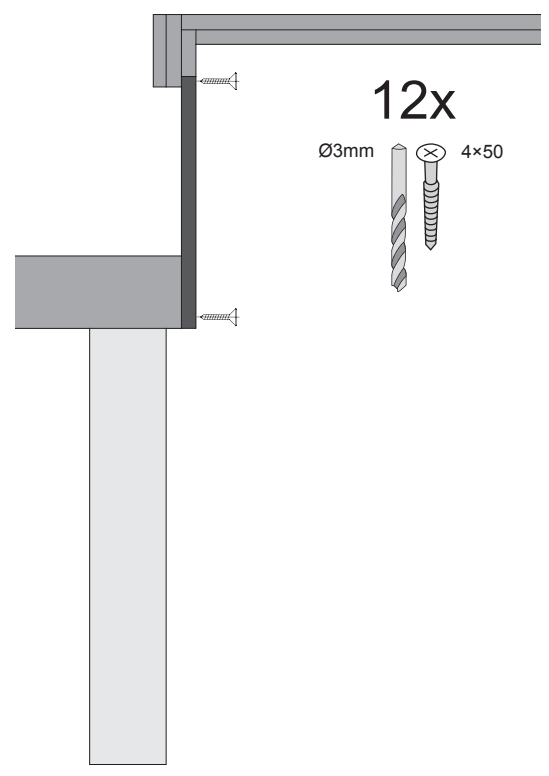
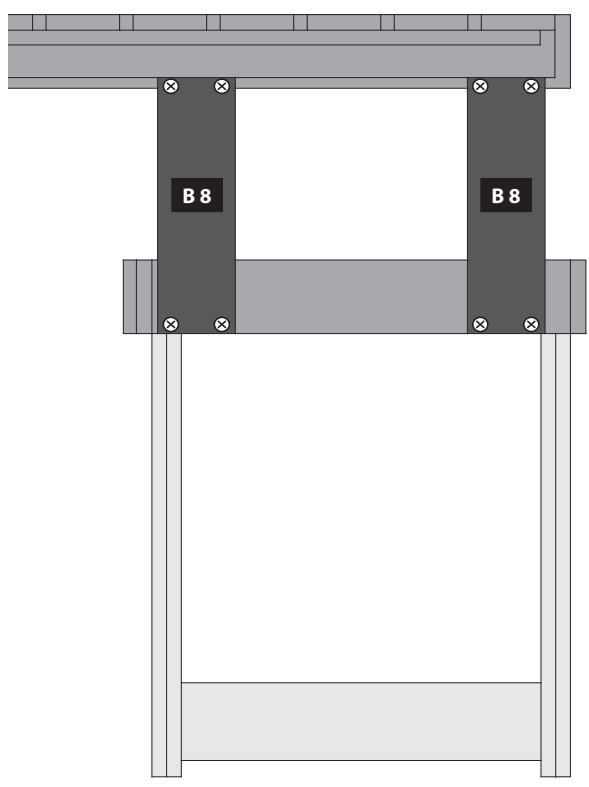
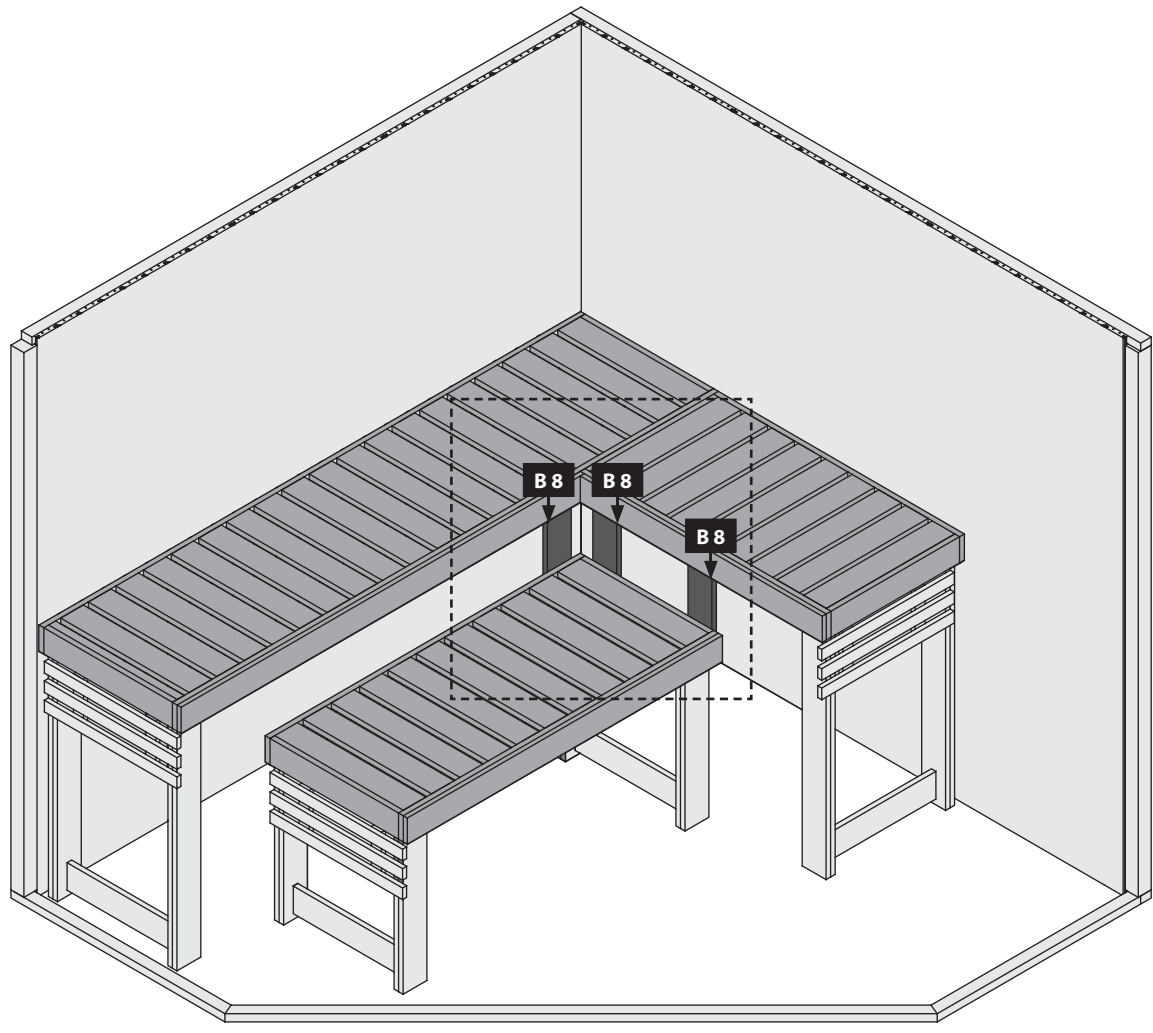

30x

Ø3mm 4x30

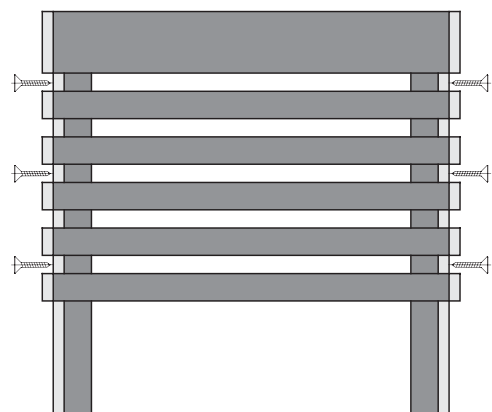
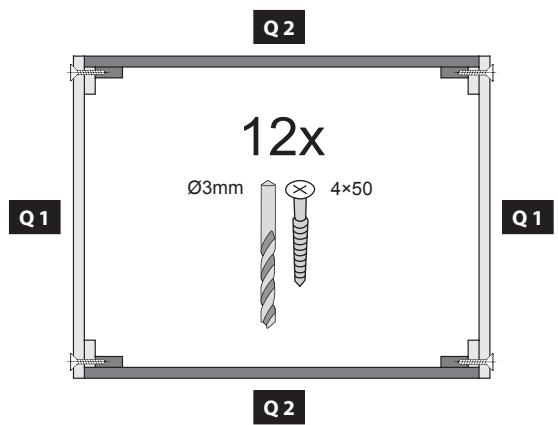
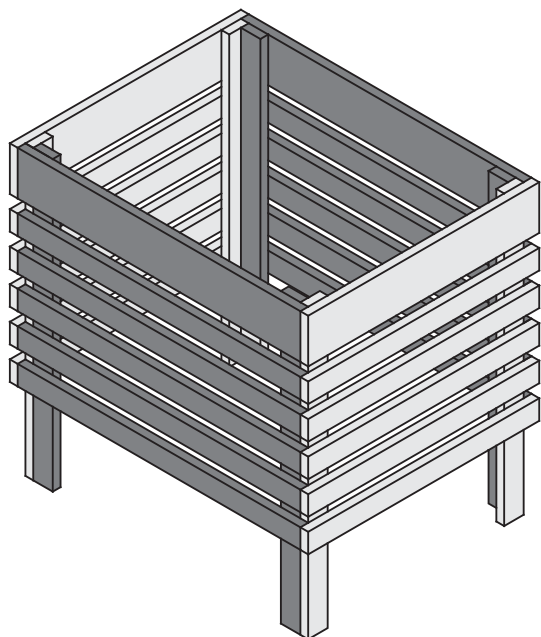
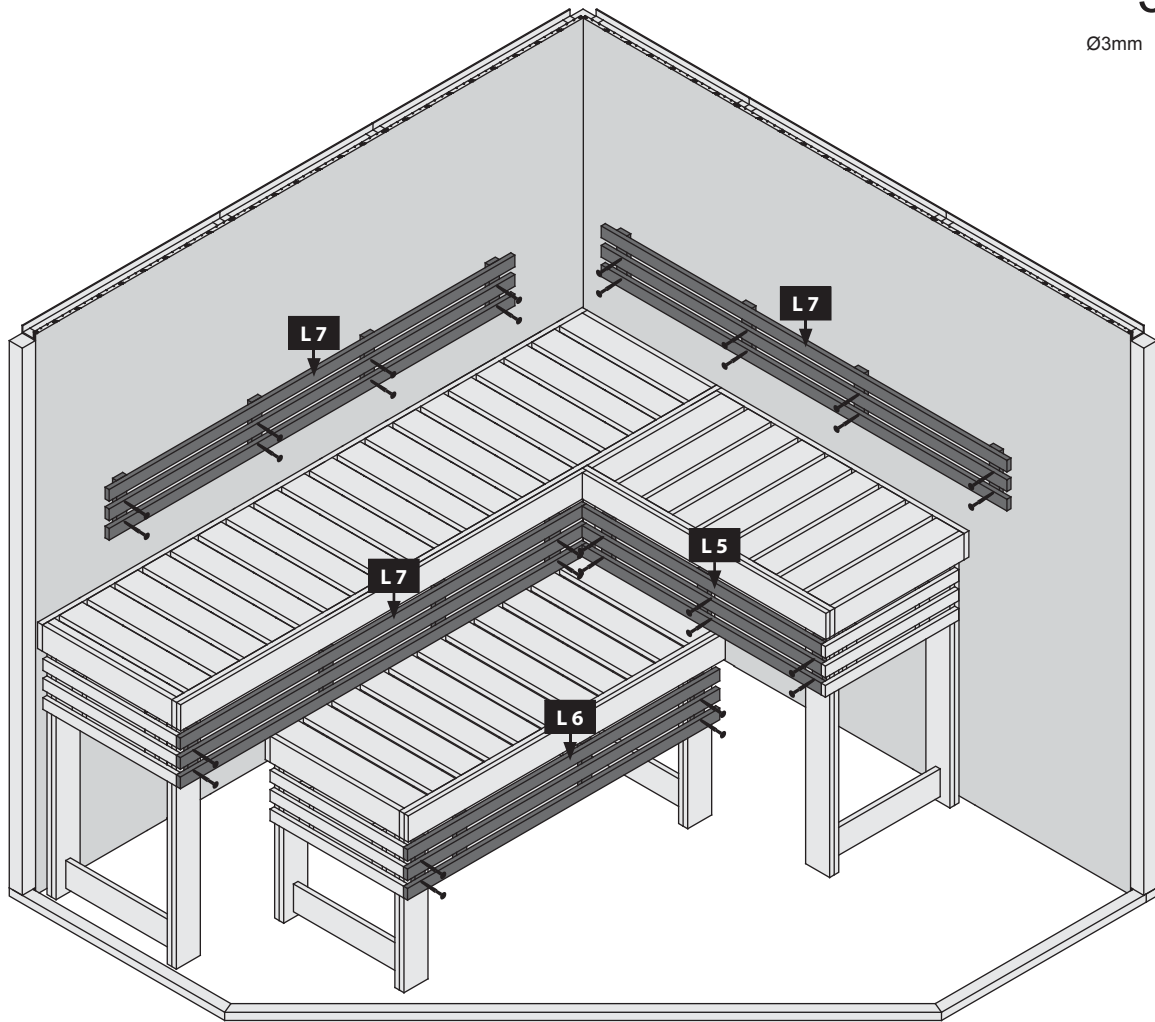



 Kabeldurchführung

 Grommet

 Mise en œuvre du câble

 Kabel implementatie





 Kabel implementering



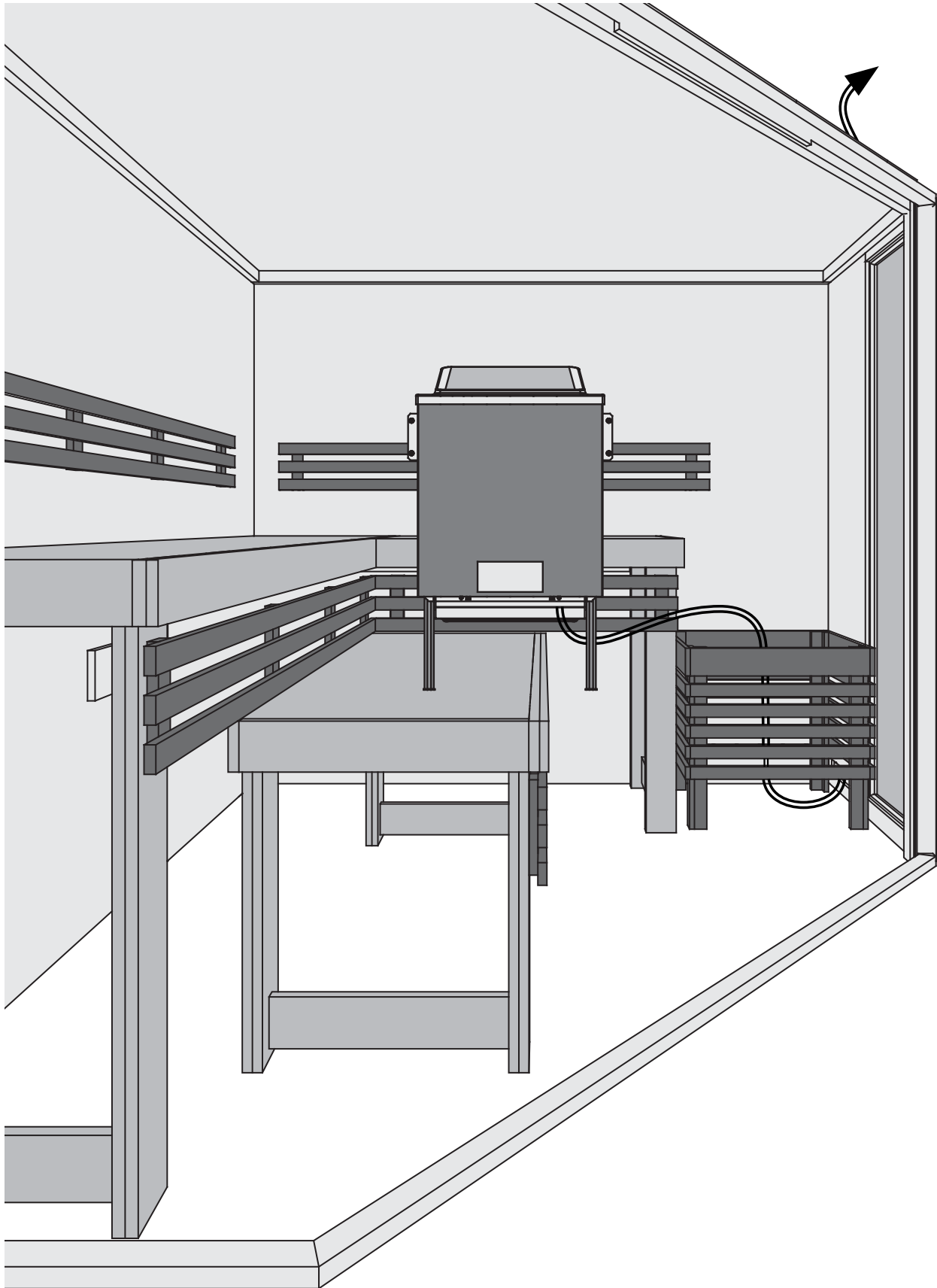

 Entrada del cable

 ingresso cavi

 kabelová průchodka



-  Einbau Glastür
-  Installation of glass door
-  Montage porte en verre
-  Montage van de glazen deur

-  Installationsglasdør
-  Montaje de la puerta de cristal
-  Installazione portello di vetro
-  Sauna Instalace dveře

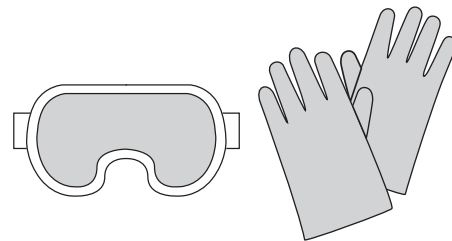

27

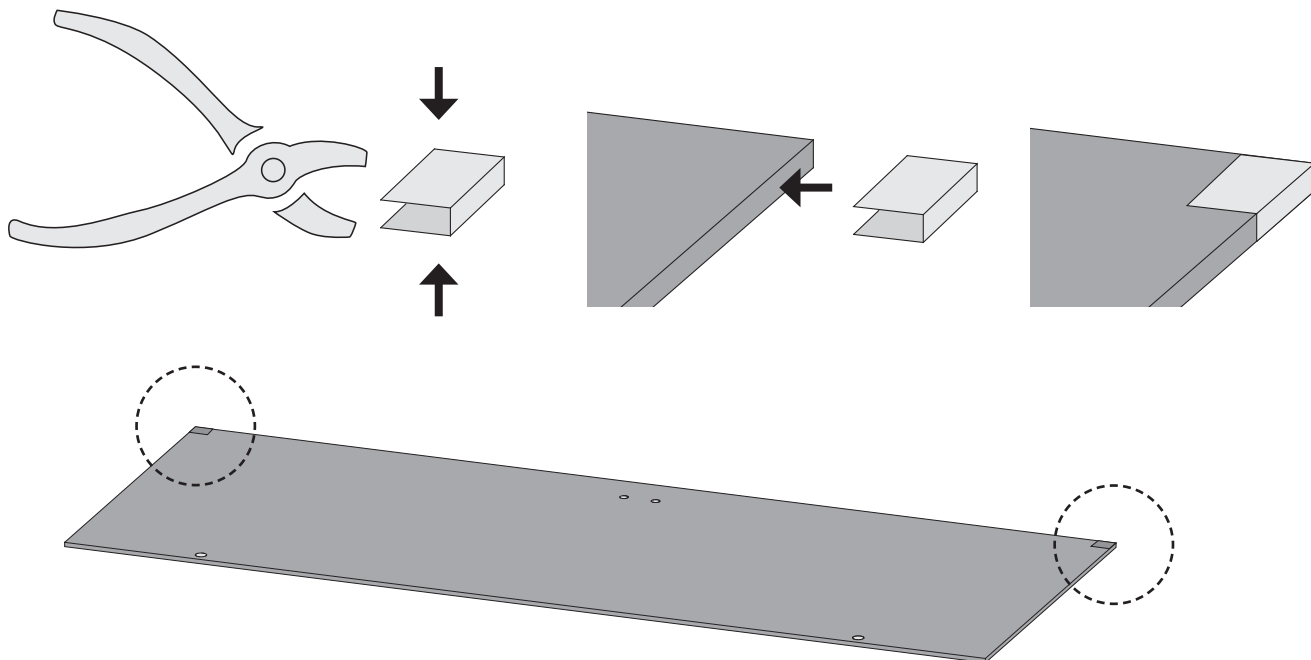



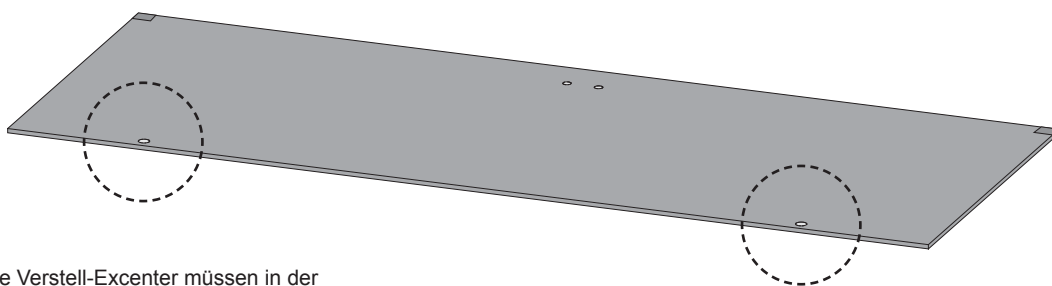



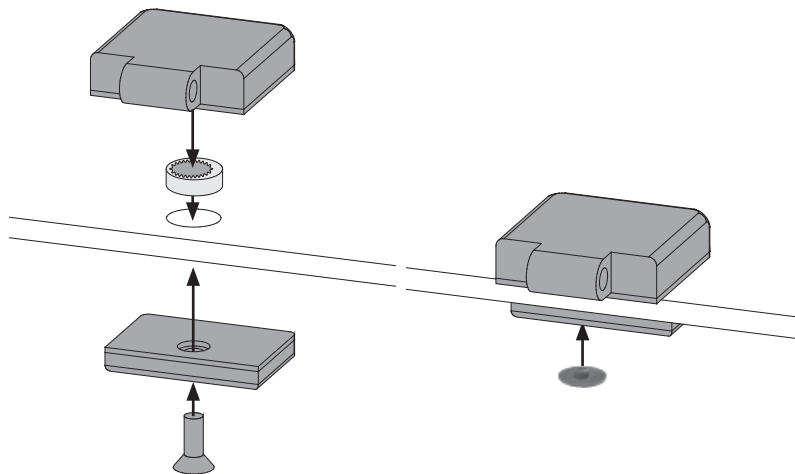

28







-  Alle Verstell-Excenter müssen in der Glasscheibe die gleiche Grundstellung haben
-  All adjustable eccentrics must have the same basic adjustment in the glass panel
-  Tous les excenteurs de positionnement doivent avoir la même position de base dans la vitre
-  Alle excentrische verstelelementen moeten in dezelfde stand in de glasplaat worden geplaatst
-  Alle justeringsexcenter skal have samme grundlæggende position i glasruden
-  Todos los excéntricos regulables tienen que tener la misma posición base en la hoja de cristal
-  Tutti gli eccentrici di regolazione devono avere la stessa posizione base nella lastra di vetro
-  šechny nastavovací podivínů musí mít stejný základní polohy ve skle



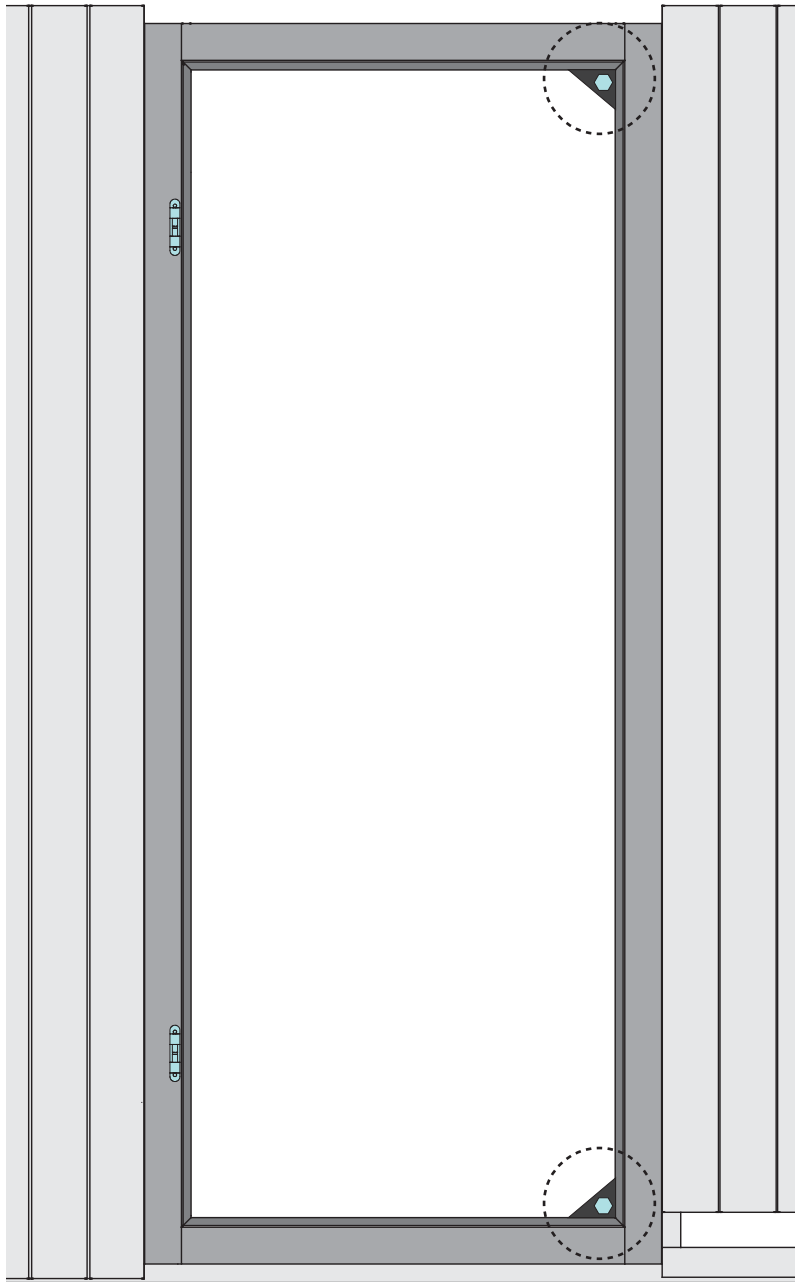
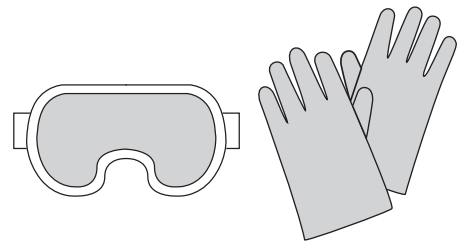



-  Einbau Glastür
-  Installation of glass door
-  Montage porte en verre
-  Montage van de glazen deur





-  Installationsglasdør
-  Montaje de la puerta de cristal
-  Installazione portello di vetro
-  Sauna Instalace dveře



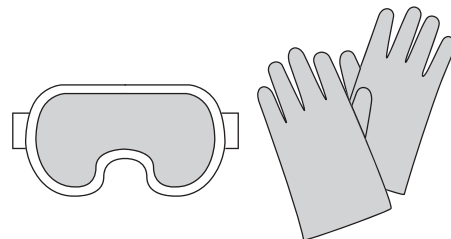



-  Einbau Glastür
-  Installation of glass door
-  Montage porte en verre
-  Montage van de glazen deur

-  Installationsglasdør
-  Montaje de la puerta de cristal
-  Installazione portello di vetro
-  Sauna Instalace dveře



-  Alle Verstell-Excenter müssen in der Glasscheibe die gleiche Grundstellung haben
-  All adjustable eccentrics must have the same basic adjustment in the glass panel
-  Tous les excentreurs de positionnement doivent avoir la même position de base dans la vitre
-  Alle excentrische verstelelementen moeten in dezelfde stand in de glasplaat worden geplaatst

-  Alle justeringsexcenter skal have samme grundlæggende position i glasruden
-  Todos los excéntricos regulables tienen que tener la misma posición base en la hoja de cristal
-  Tutti gli eccentrici di regolazione devono avere la stessa posizione base nella lastra di vetro
-  šechny nastavovací podivínů musí mít stejný základní polohy ve skle

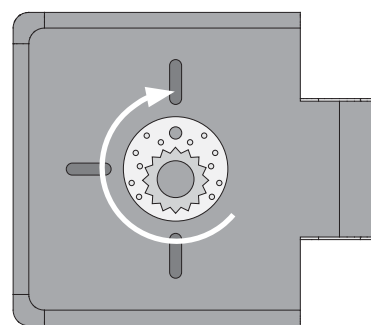
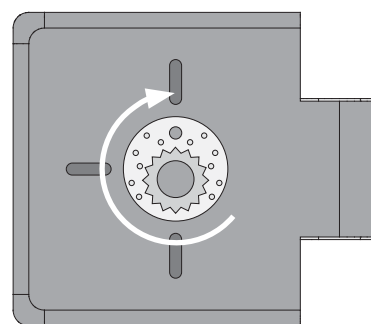
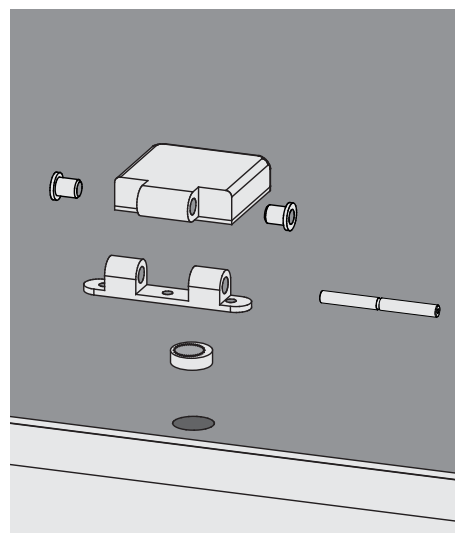
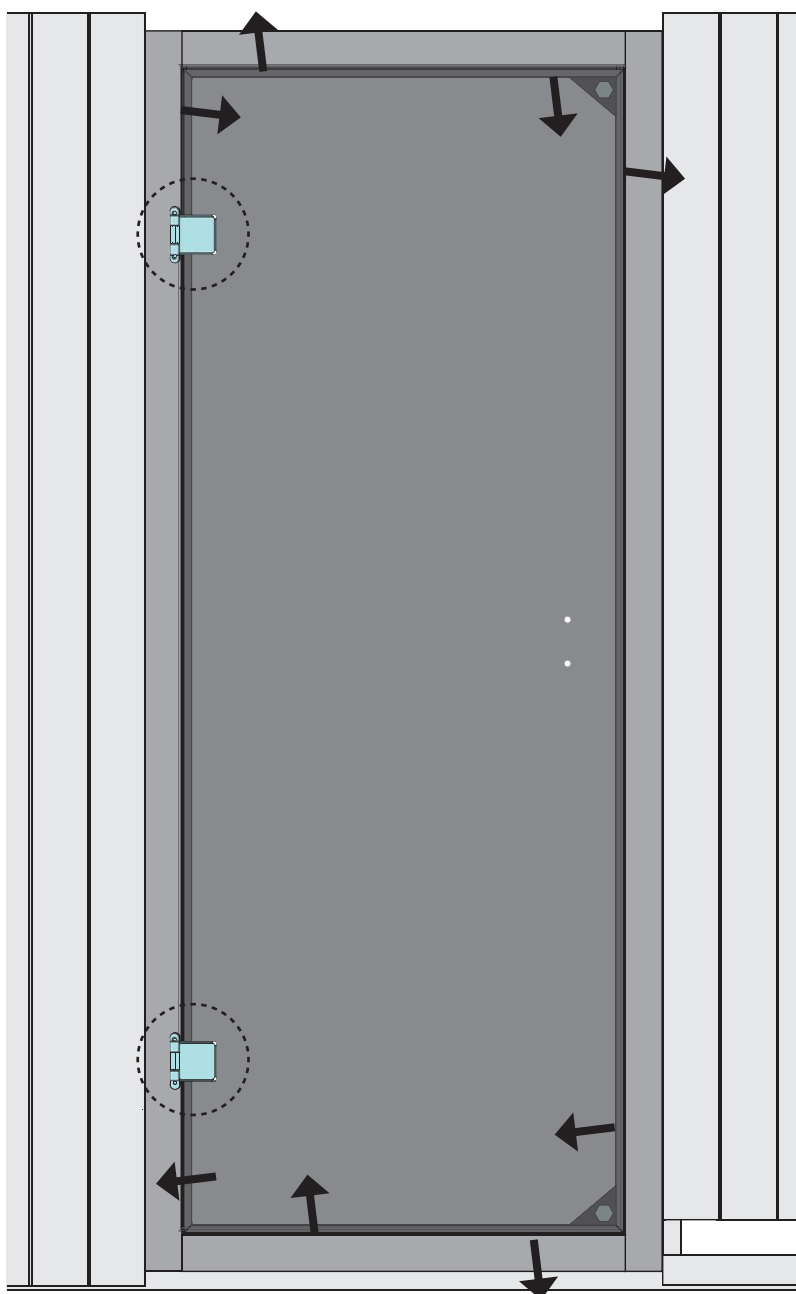

1.

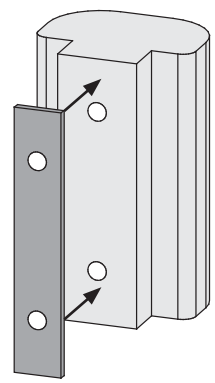

2.

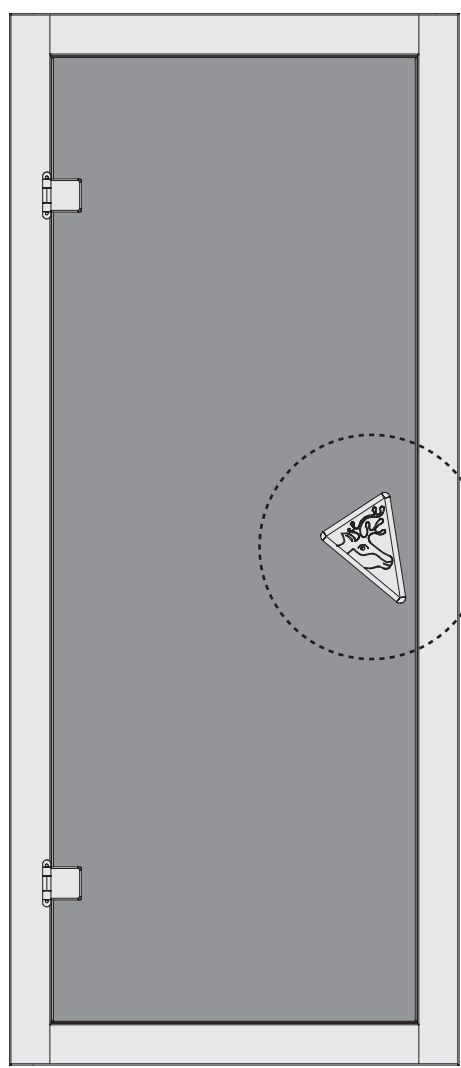
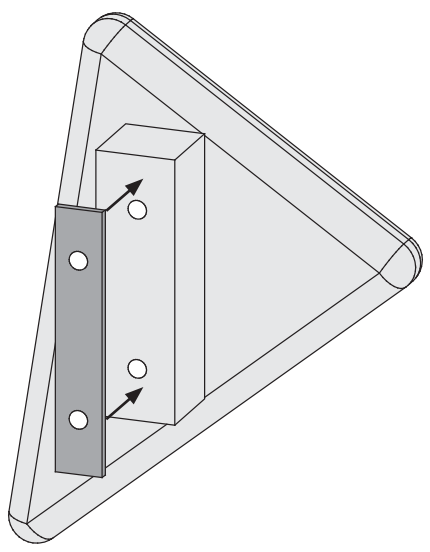

3.

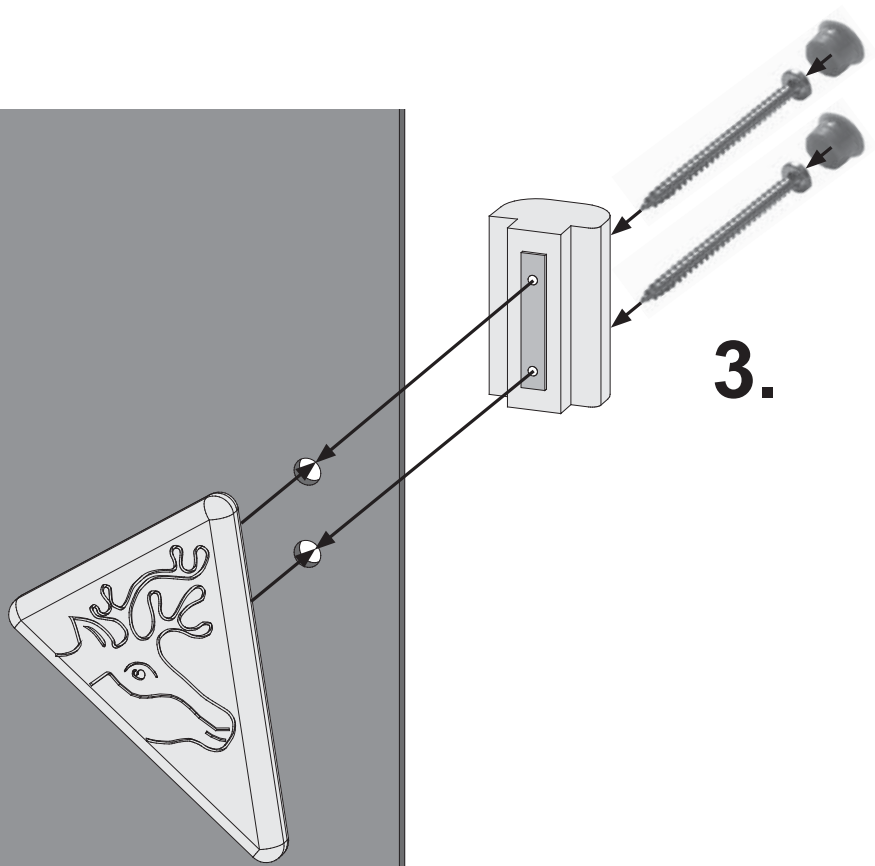

 Installation TÜV-Schild

 Installatie TÜV Shield

 Instalace TÜV Shield

 Installation TÜV Shield

 Installazione TÜV Shield

 Namestitev TÜV tablice

 Installation TÜV Shield

 Instalación TÜV Escudo

01

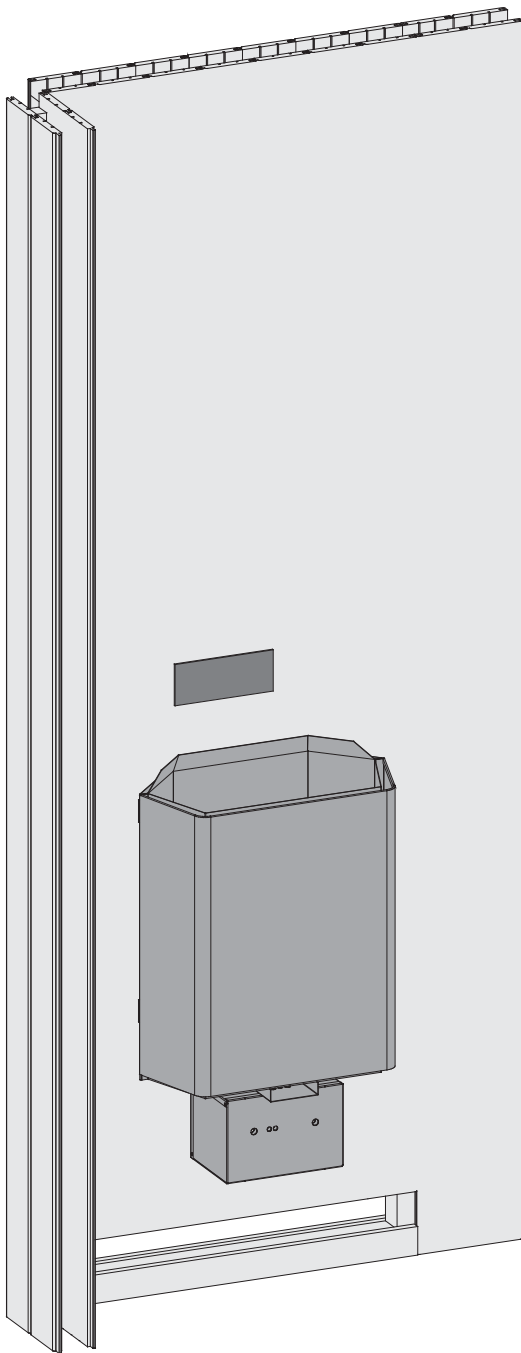



 Entfernen Sie die Schutzfolie vom beiliegenden TÜV-Schild. Lassen Sie den Saunaofen von einem zugelassenen Elektrofachmann anschließen. Dieser markiert den installierten Ofen auf dem TÜV-Schild. Bringen Sie das TÜV-Schild an einer gut sichtbaren Stelle über dem Ofen an.

 Remove the protective film from the accompanying Participate Schild. Lassen connecting the heater by a licensed electrician. This marks the installed furnace on the TÜV sign. Attach the TÜV sign at a conspicuous place on the stove.

 Retirez le film protecteur de l'accompagnant Participer Schild. Lassen raccorder l'appareil par un électricien agréé. Ceci marque le four installé sur le signe TÜV. Fixer le signe de TÜV à un endroit bien en vue sur le poêle.

 Verwijder de beschermfolie van de begeleidende Deelnemen Schild. Lassen het aansluiten van de kachel, door een erkende elektricien. Dit markeert de geïnstalleerde oven op het TÜV teken. Bevestig de TÜV teken op een opvallende plaats op het fornuis.

 Rimuovere la pellicola protettiva dal accompagna Partecipa Schild. Lassen collegando il riscaldatore da un elettricista qualificato. Questo segna il forno installato sul segno TÜV. Fissare il segno TÜV in un luogo ben visibile sulla stufa.

 Retire la película protectora de la Schild. Lassen acompaña Participar conectar el calentador por un electricista autorizado. Esto marca el horno instalado en el signo TÜV. Coloque el cartel de TÜV en un lugar visible en la estufa.

02

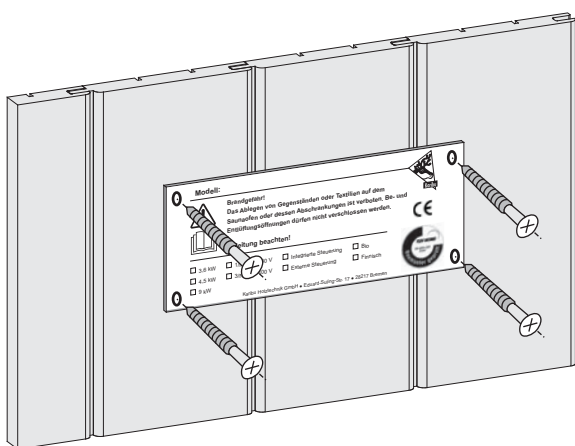

 Odstraňte ochrannou fólii z doprovodného Hlavní Schild. Lassen připojení ohříváče licencovaným elektrikář. Toto označí Instalovaný pec na znamení TÜV. Připevněte znamení TÜV na dobře viditelném místě na sporáku.

 S priložene tablice odstranite zaščitno folijo. Peč savne naj priključi usposobljeno osebnje, ki inštalirano peč označi na TÜV tablici. Tablico namestite na vidno mesto peči.

