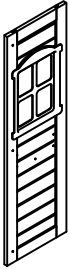
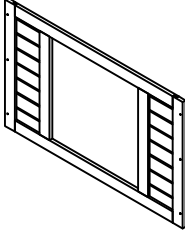
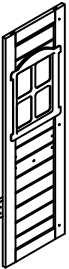
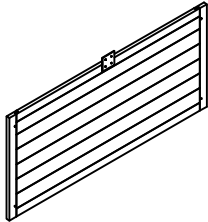
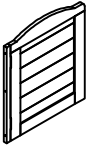
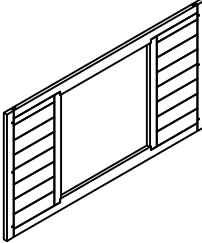
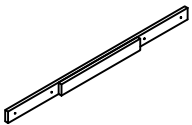
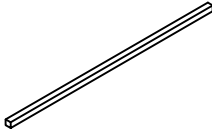
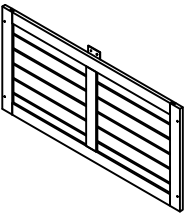
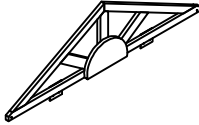
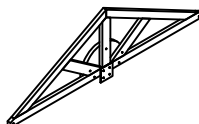

1		1PC	6		2PCS
2		1PC	7		1PC
3		1PC	8		1PC
4		1PC	9		4PCS
5		2PCS	10		1PC
			11		1PC

NO:5-1

12		2PCS	17		2PCS
			18		4PCS
13		2PCS	A		12PCS
14		1PC	B		34PCS
15		2PCS	C		18PCS
16		2PCS	D		45PCS
1					
2					

NO:5-2

3

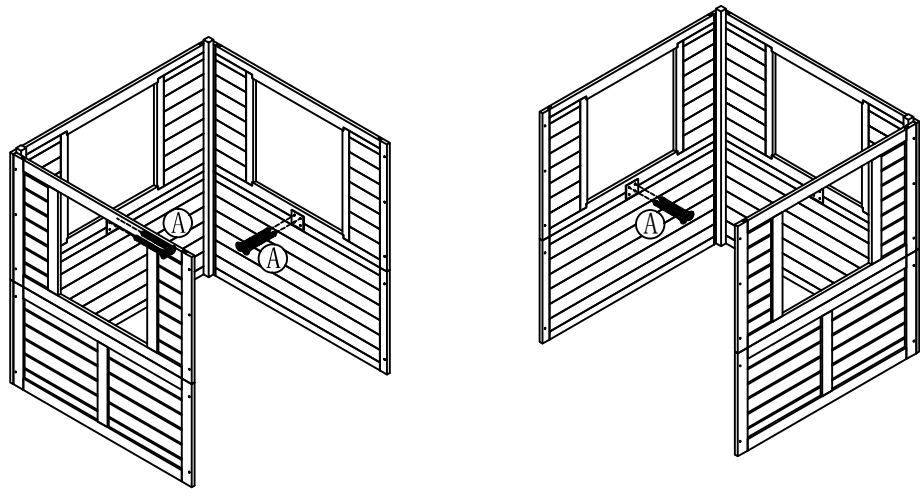

4

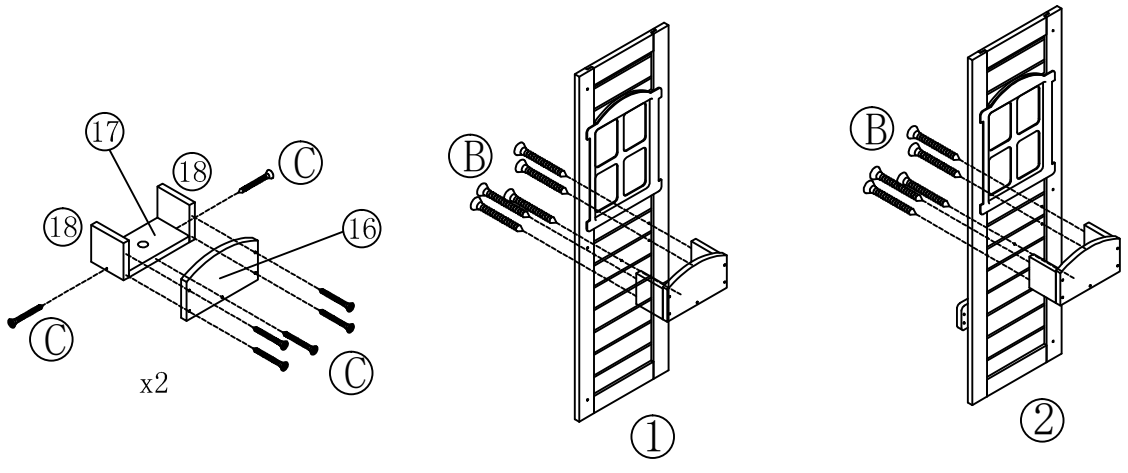

5

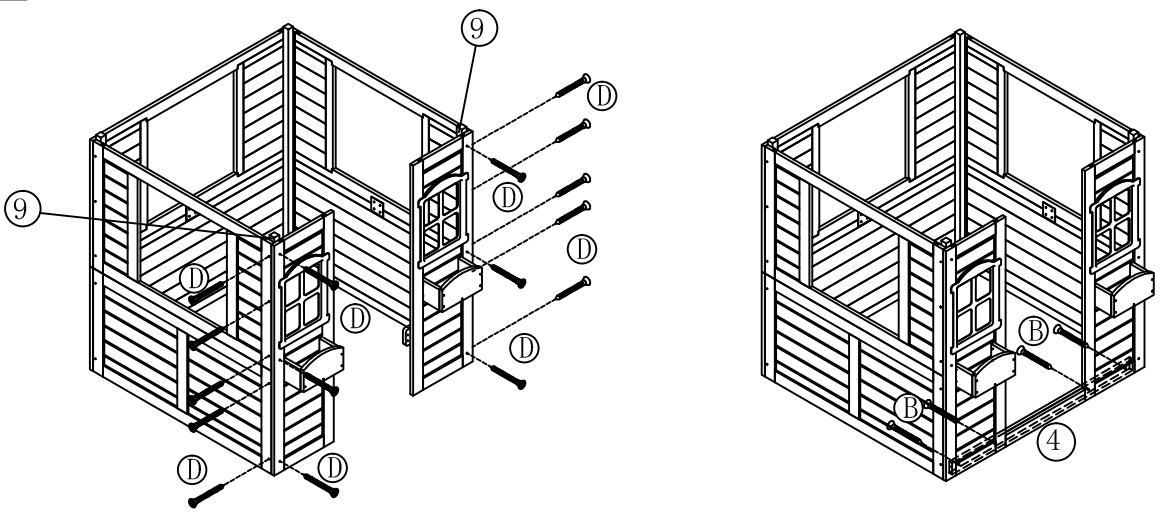

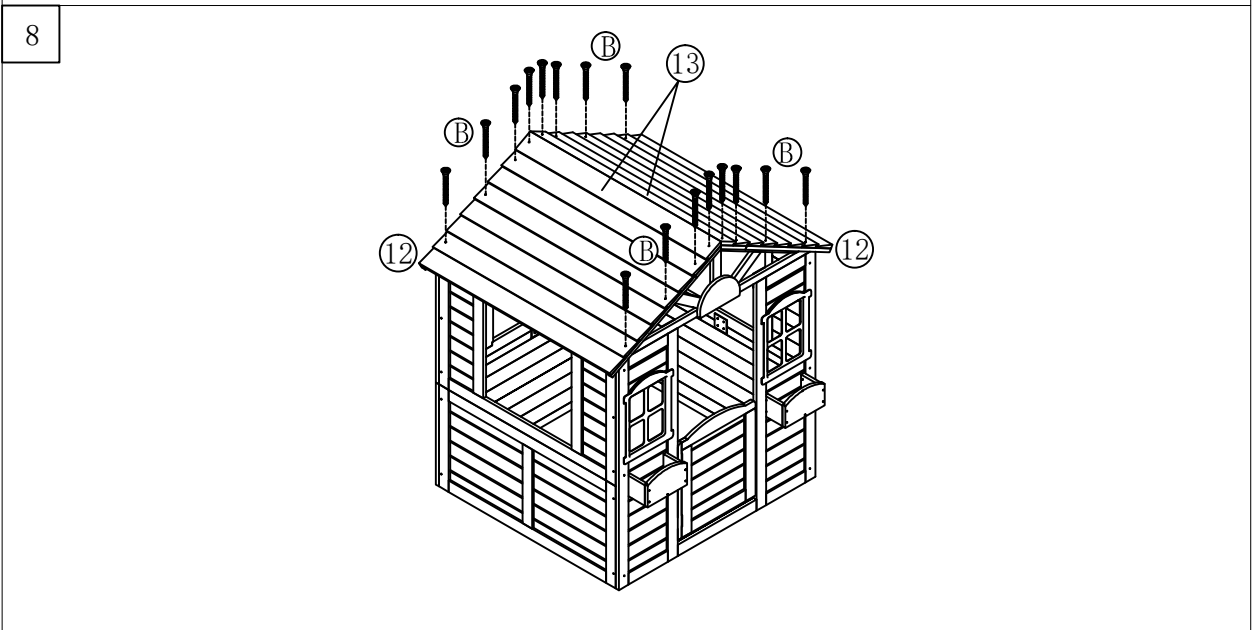
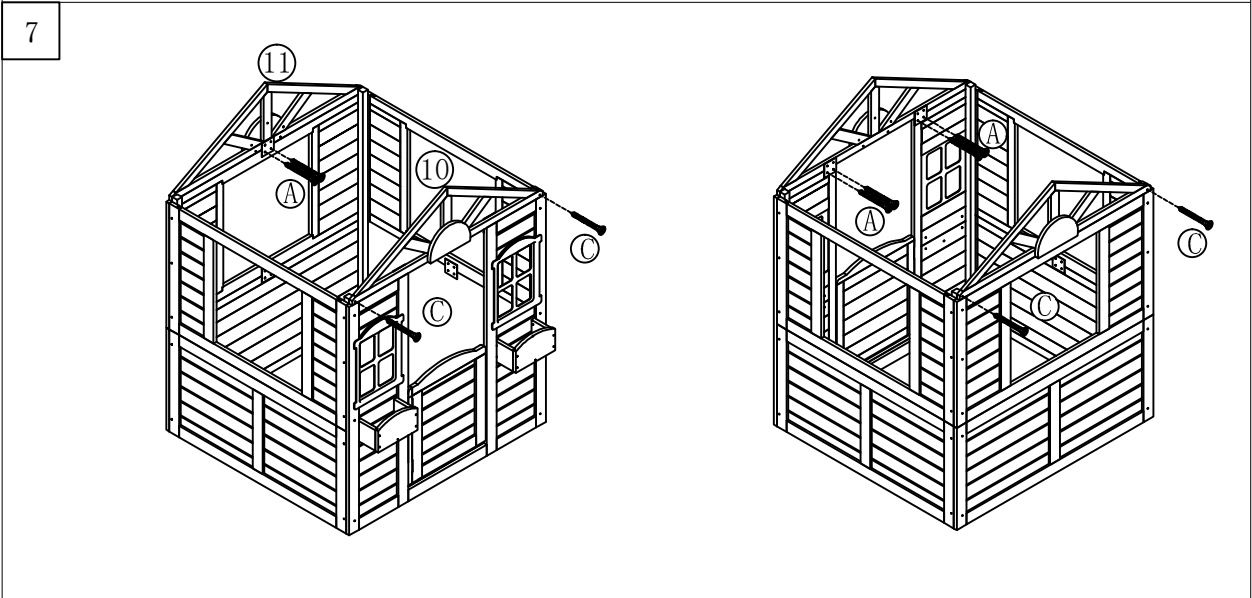
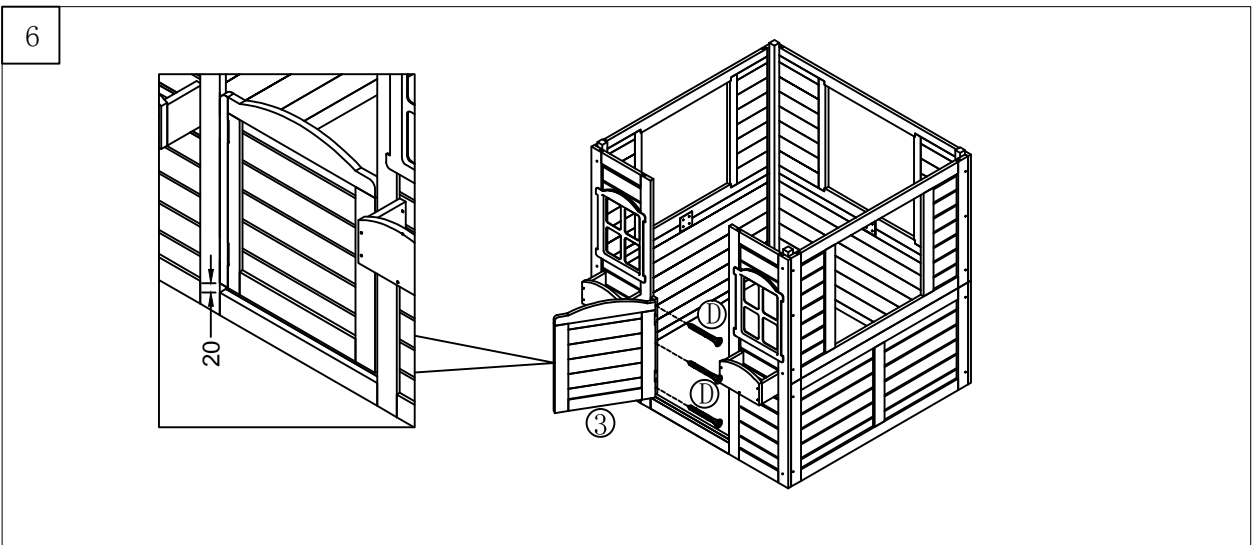

9

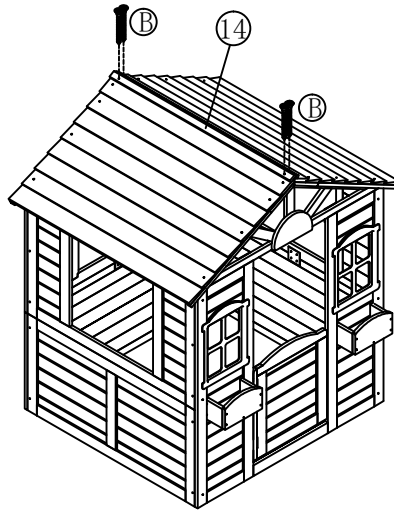

10

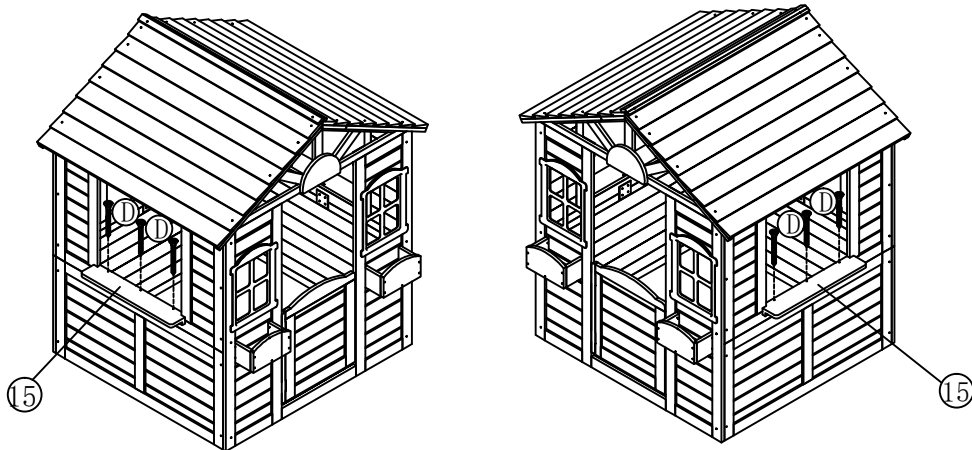

Hergestellt für Holzland Becker GmbH, Albrecht-Dürer-Str.25 63179 Obertshausen

NO: 5-5



ACHTUNG! ERSTICKUNGSGEFAHR.
NICHT für Kinder unter drei Jahren geeignet wegen verschluckbarer Kleinteile.

