

18  
mm

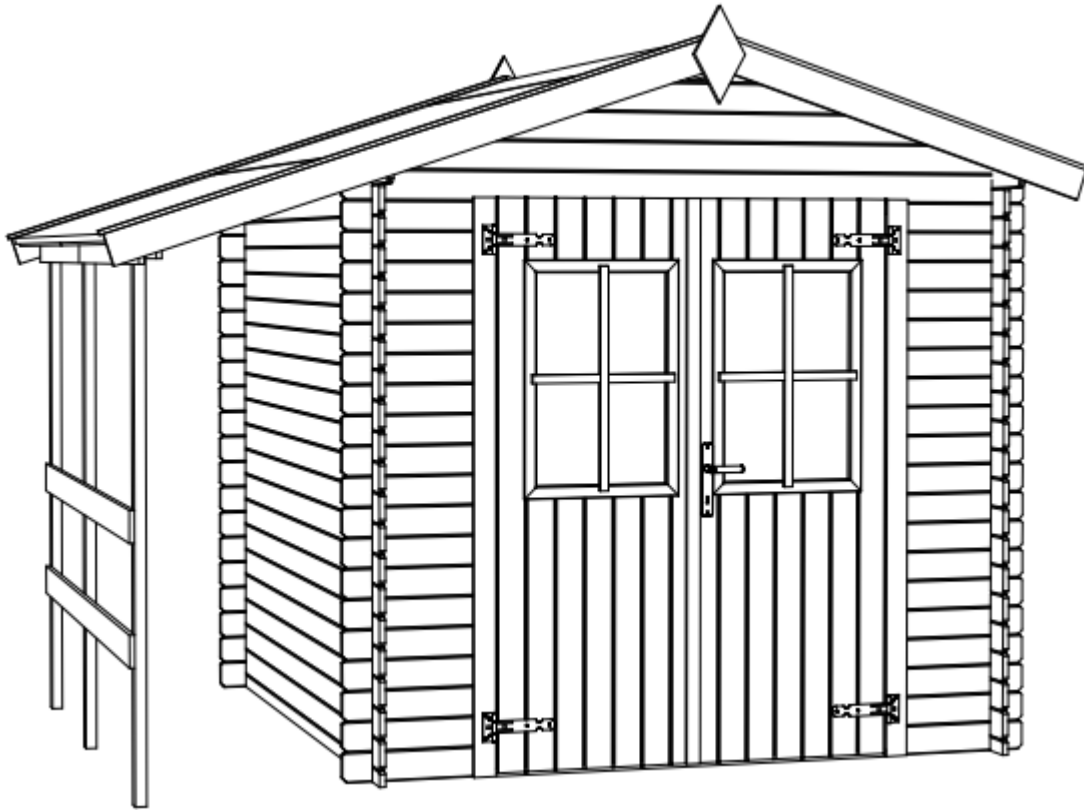

PROD.Nr.:



1415

Gartenpro Kft.  
9444 Fertőszentmiklós  
Soproni úti ipartelep  
HUNGARY  
16  
1415-CPR-43-(C-80/2015)  
ETA-15/0873  
ETAG 007







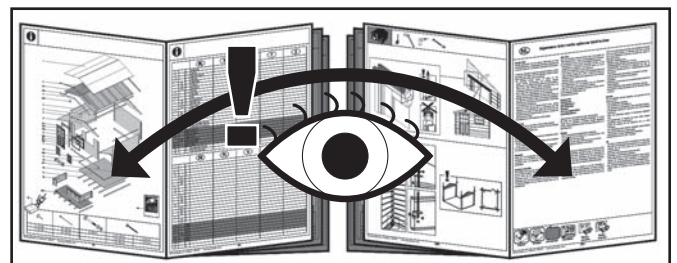

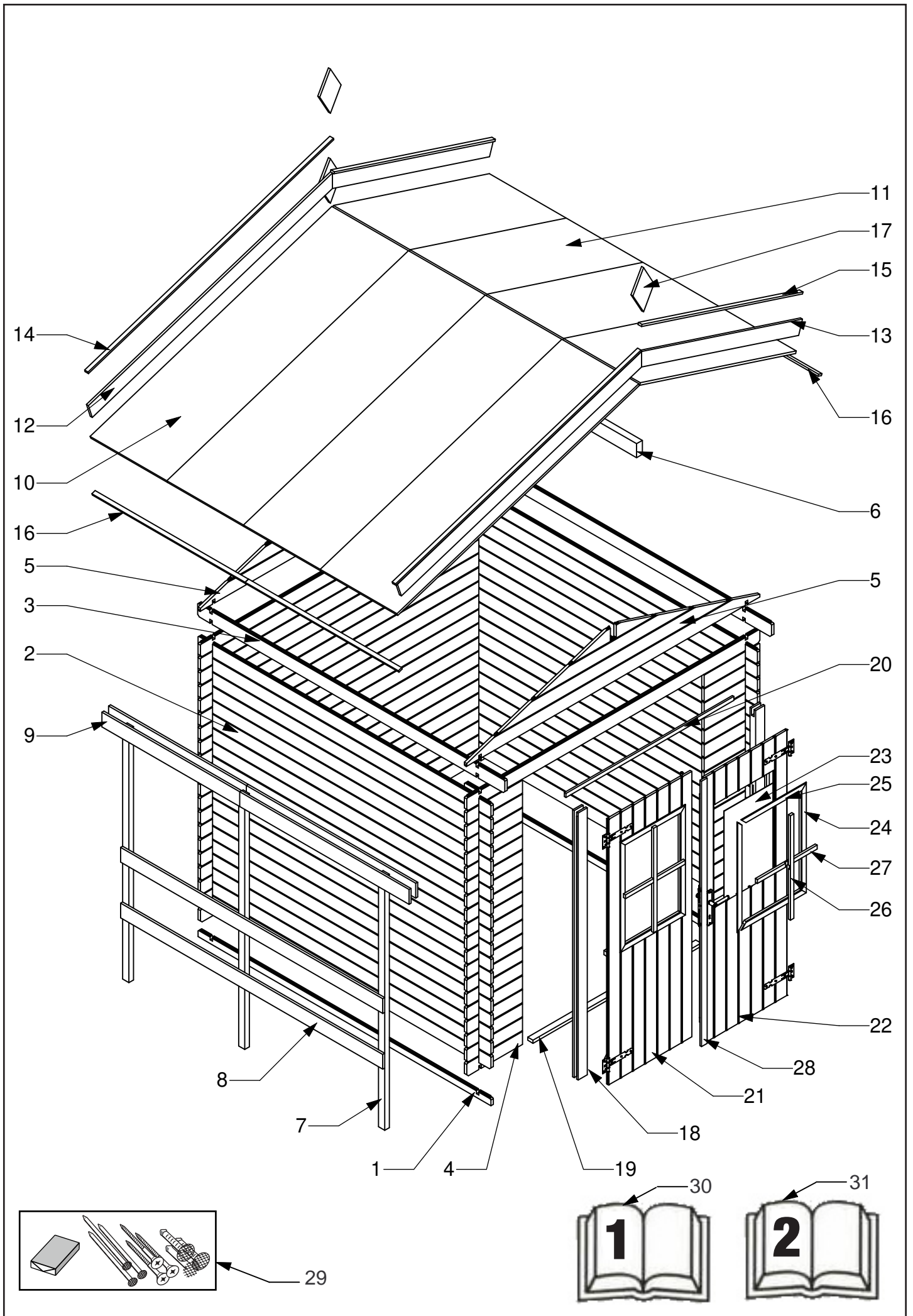









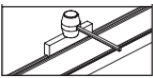

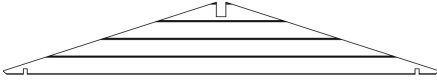

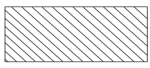

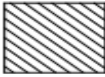

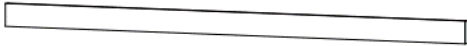
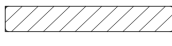

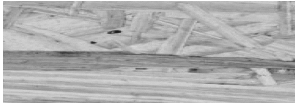





V 2020 18 Juist 5 F0R0B1  
Art.Nr.: G1820202  
Ean.Nr. 5999553062311



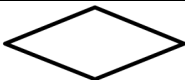





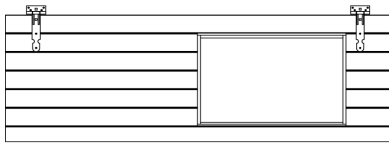

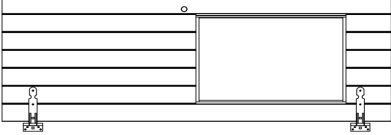



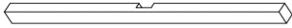

Hout voor Outdoor Life Products blokhutten en tuinhuizen is vooral afkomstig uit gecertificeerde en goed beheerde bossen.  
Wood used for our Outdoor Life Products cabins and garden houses is mostly sourced from certified and well-managed forests.  
Das Holz für Outdoor Life Products Blockbohlenhäuser und Gartenhäuser wird größtenteils aus zertifizierten Wäldern bezogen.  
Les bois pour chalets et maisons de jardin de Outdoor Life Products proviennent en grande partie de forêts certifiées et gérées durablement.





1.	G2222277			18X53X2180	2X
2.	G2222283			18X98X2180	59X
3.	G2222297			18X98X2285	2X
4.	G2223161			18X98X414	38X
4A.	G5157074			18X98X414	2X
5.	G2230170			18X367X2180	2X
6.	G601905			43X90X2285	1X
7.	G2223179			34x46x1633	3X
8.	G2222410			15x95x1950	2X
9.	G2223513			15X95X1260	4X
10.	G2230270			12x571x1890	4X
11.	G2230303			12x571x1220	4X
12.	G2222411			15X95X1910	2X
13.	G2224231			15x95x1260	2X
14.	G60147540-1920			12X26X1920	2X
15.	G60147540-1270			12x26x1270	2X
16.	G60147540-1140			12X26X1140	4X
17.	G591124				2X
18.	G2222339			42X68X1720	2X
19.	G5156106-1250			20,6X40X1250	1X
20.	G60147540-1250			12x26x1250	1X
21.	G2230031			620X1710 zü	1X

22.	G2230032			620X1710 MIDI	1X
23.	G60199935			435X659X2	2X
24.	G601470571-712	 		18x38x712	4X
25.	G601470571-485	 		18x38x485	4X
26.	G60463921K-673	 		15X25X673	2X
27.	G60463921K-445	 		15X25X445	2X
28.	G2222494	 		12x42x1740	1X
29.	G2230304			V2020 Juist 5	1X
30.	G6099908		Building instr.	Útm. Építési	1X
31.	G6065190		General Conditions	Útm. Általános	1X



1

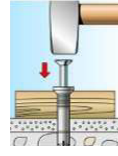
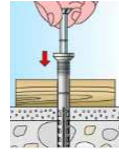
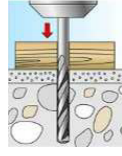
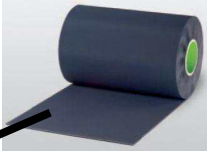
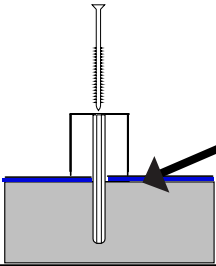
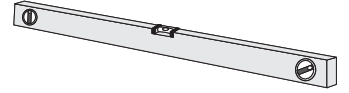
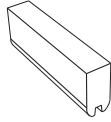
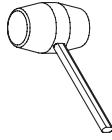

## POS

1.  18x53x2180 2X

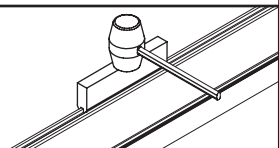
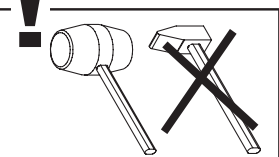
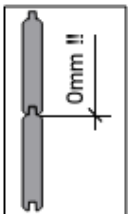
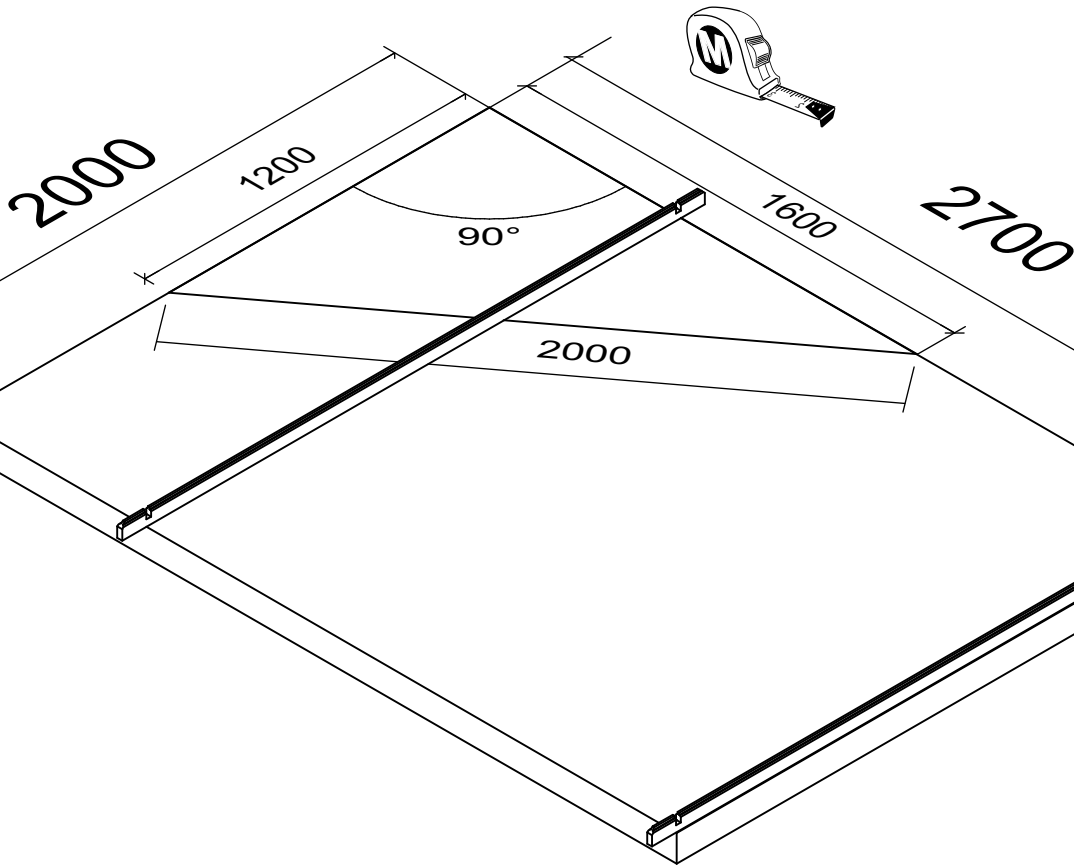

2

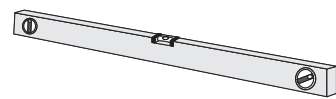
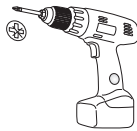
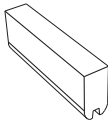
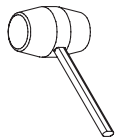

POS

2.  18X98X2180 3X

4.  18X98x414 2X

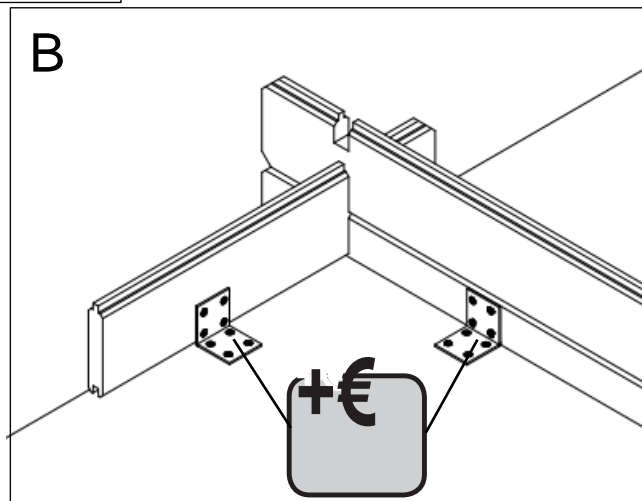
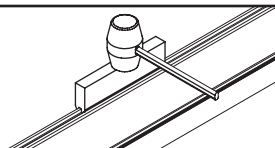
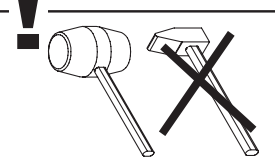
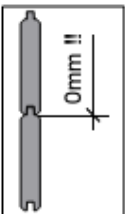
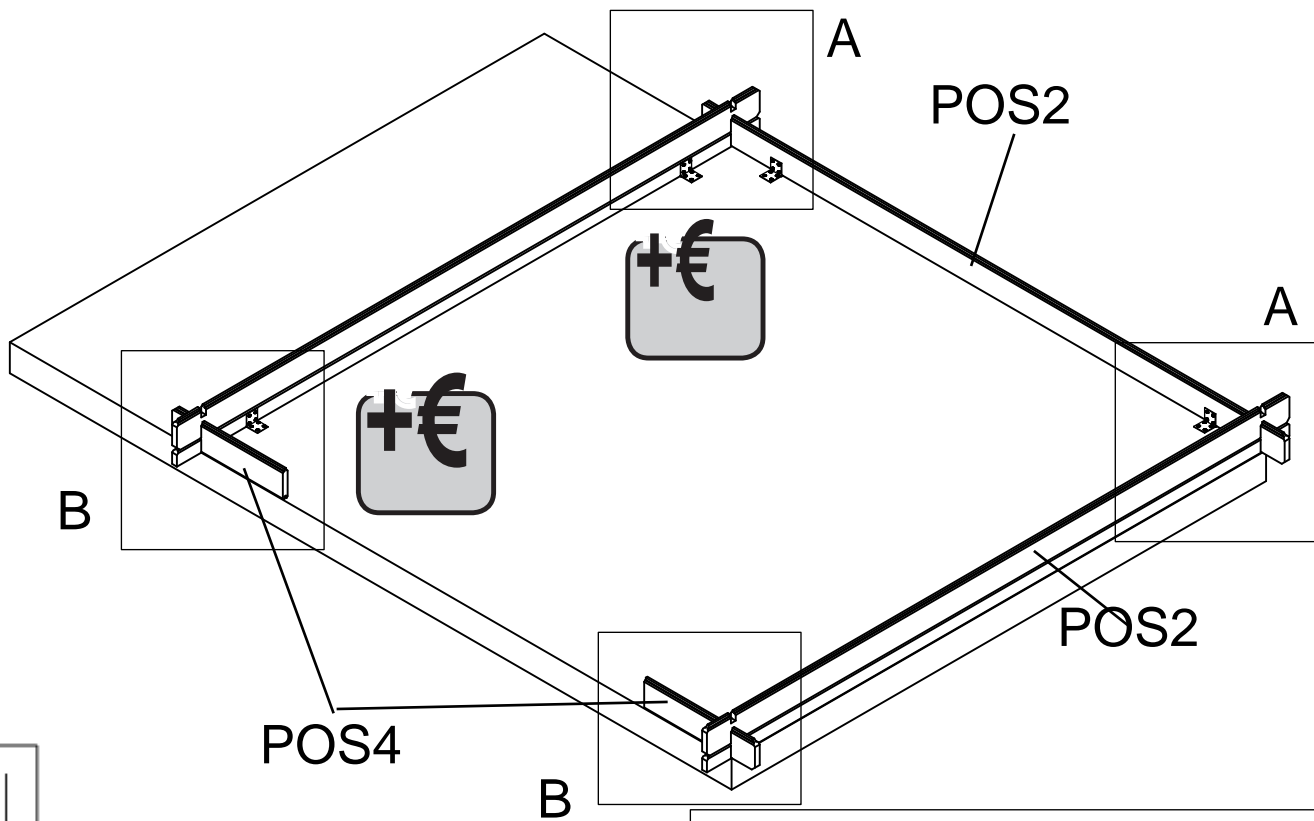
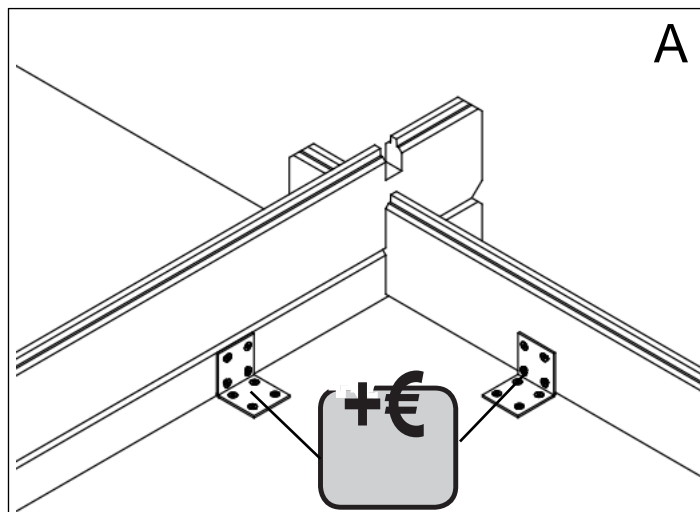

3

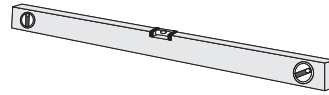
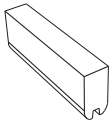
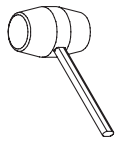

POS

2.  18X98X2180 56X

4.  18X98x414 36X

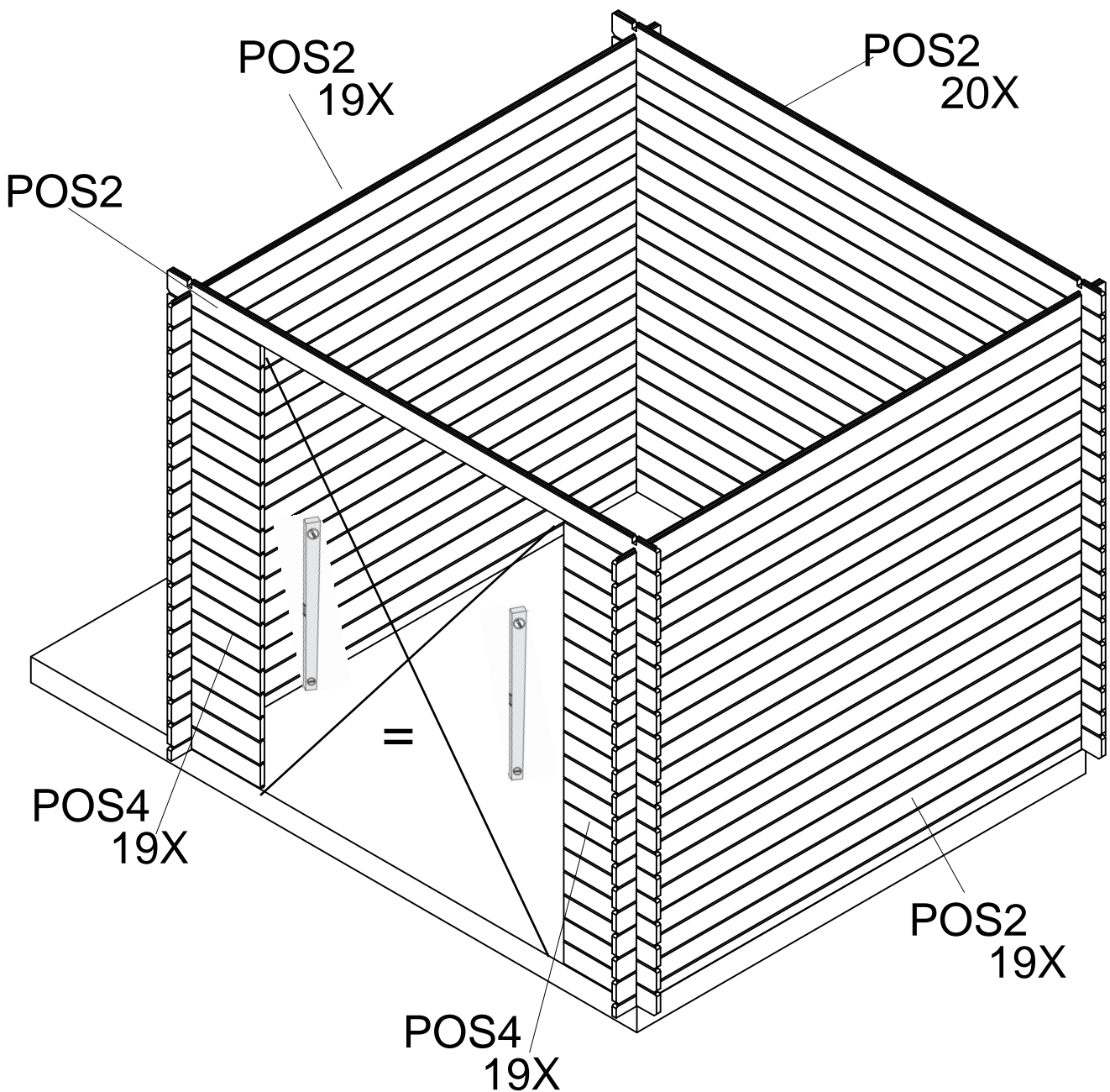
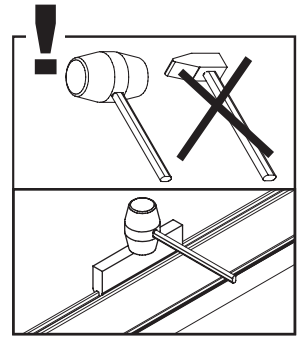
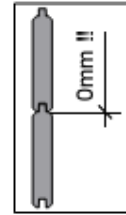



4

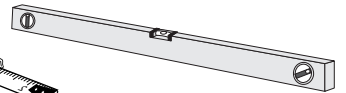
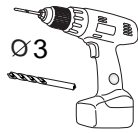
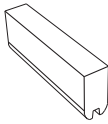
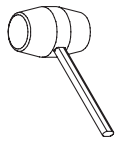

POS

3.  18X98X2285 2X

5.  18X367x2180 2X

 X4  
4x50mm

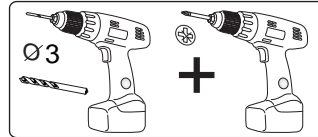

 4x50mm

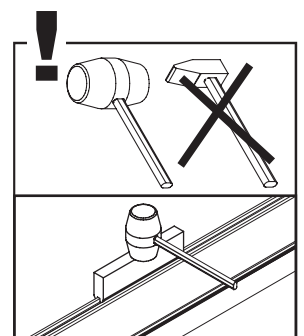
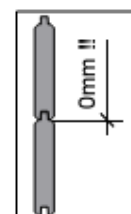
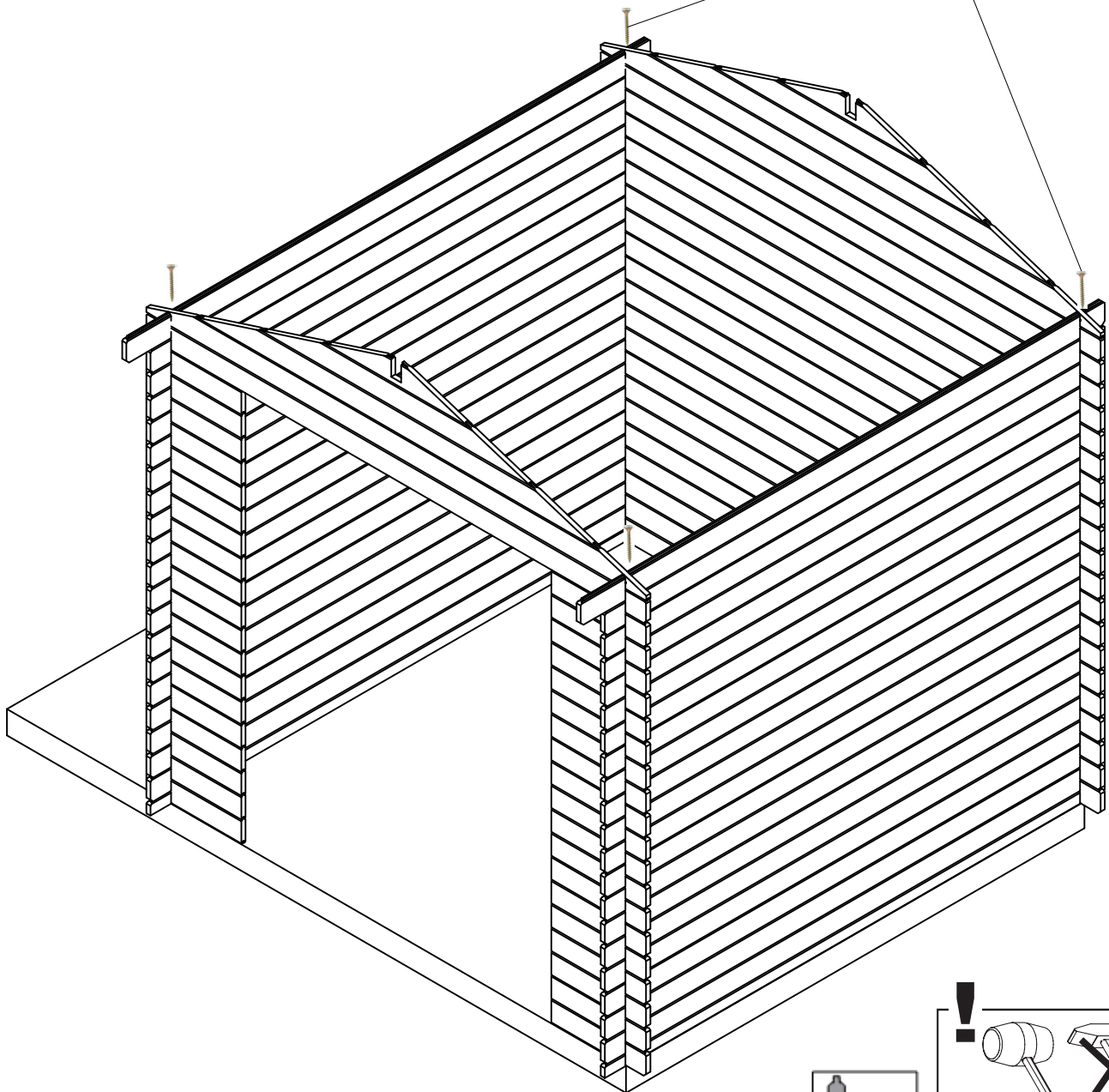

5

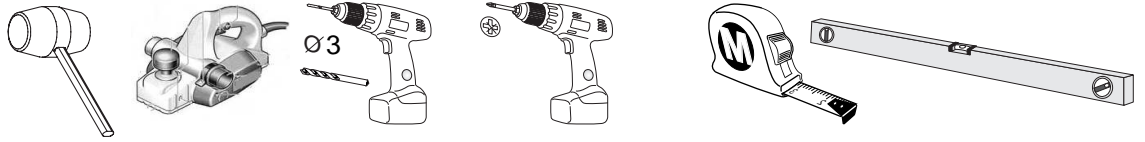

POS

6.  43X90X2285 1X

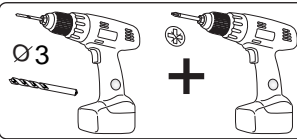

X4

4x50mm

B

A

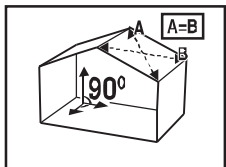

POS6

B

A

B

B

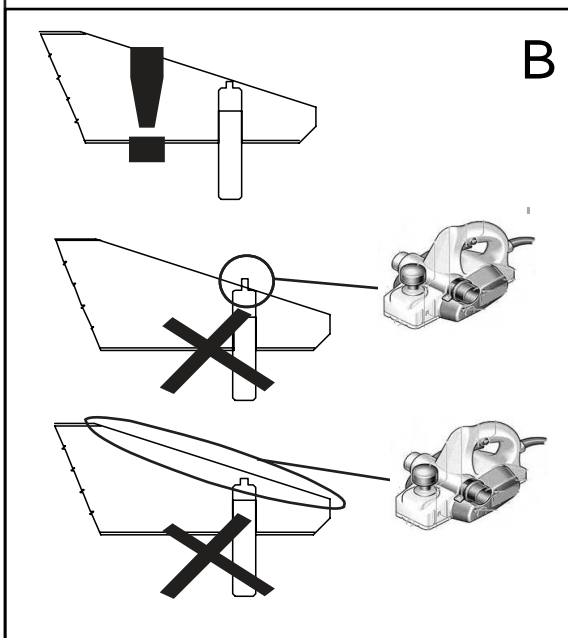

B

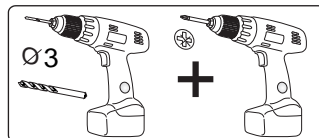

4x50mm

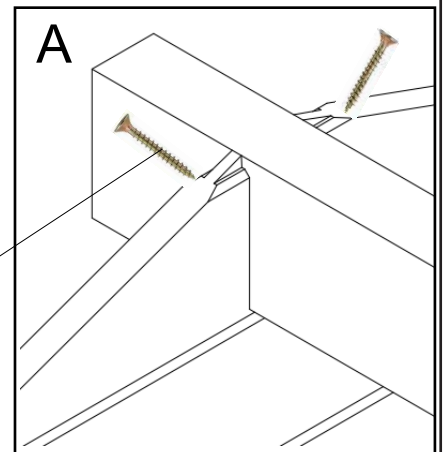

A

6

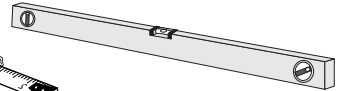

POS

18  42x68x1720 2X

19  20,6x40x1250 1X

20  12x26x1250 1X



6X

3,5x25mm

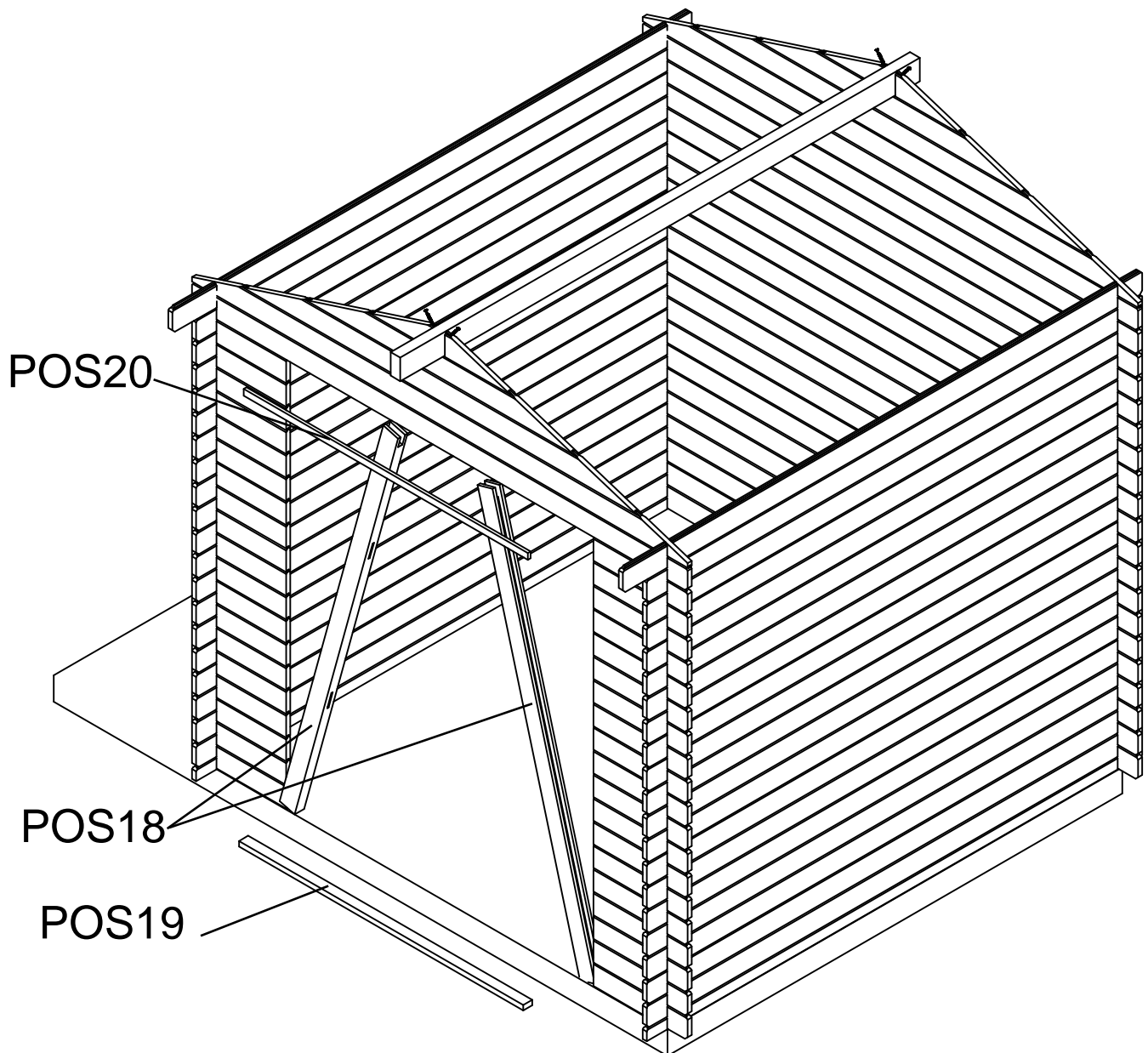

7

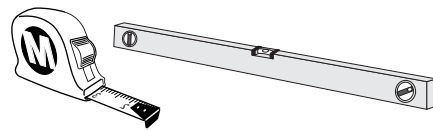
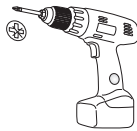
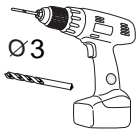

4X



6X

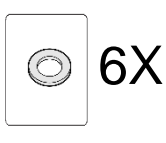

6X

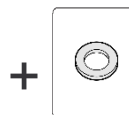
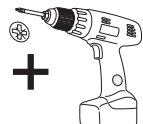
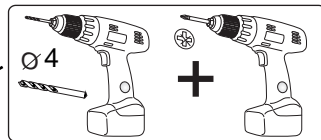
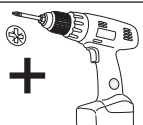
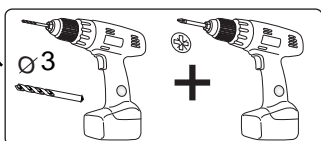
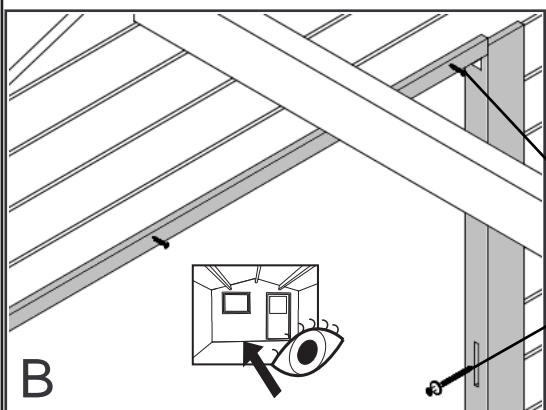
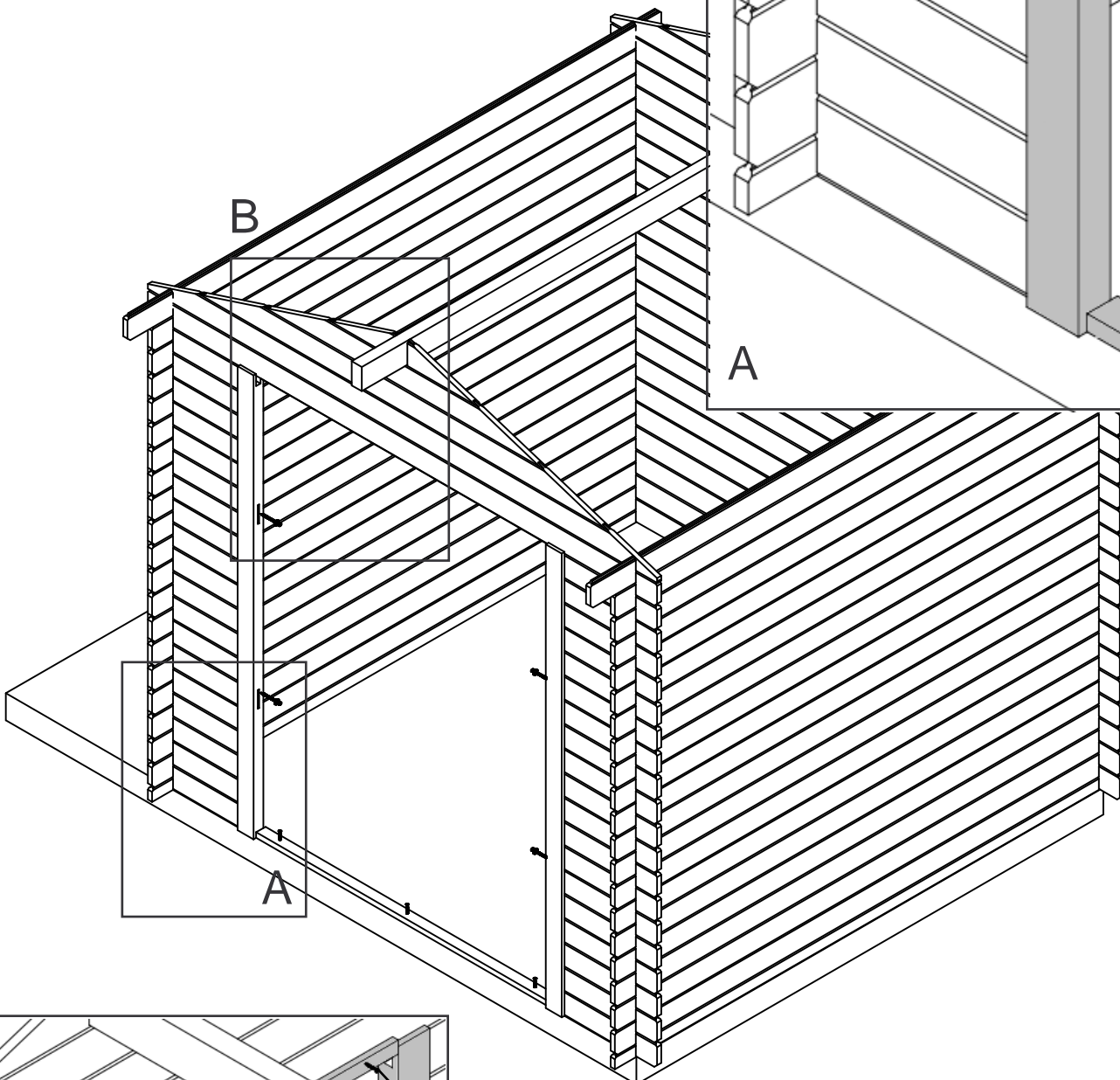
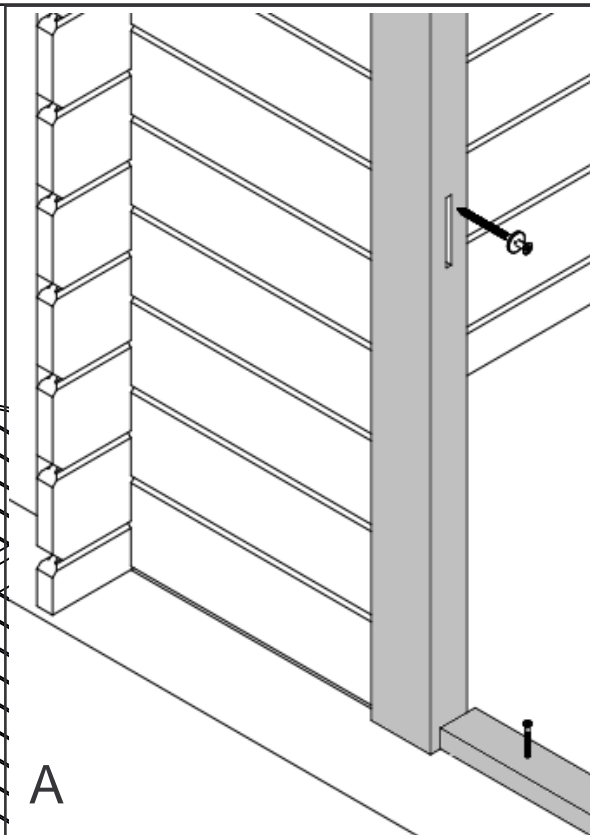

8

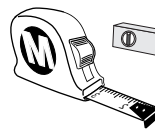
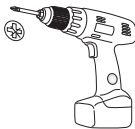
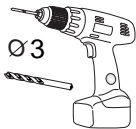
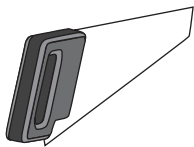

POS

7  34x46x1633 3X

8  15x95x1950 2X

9  15x95x1260 4X

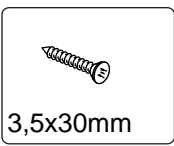

28x

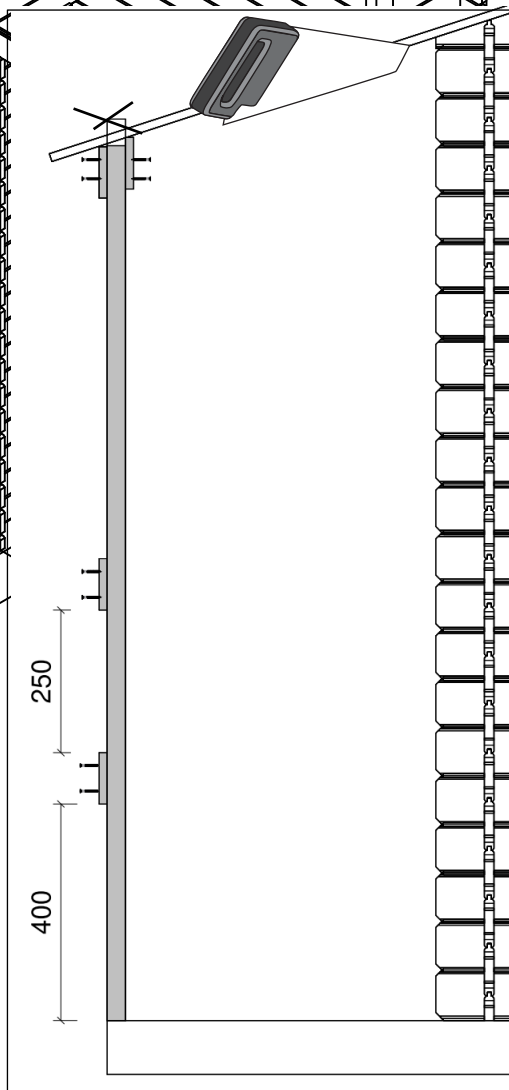
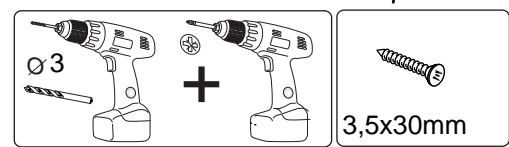
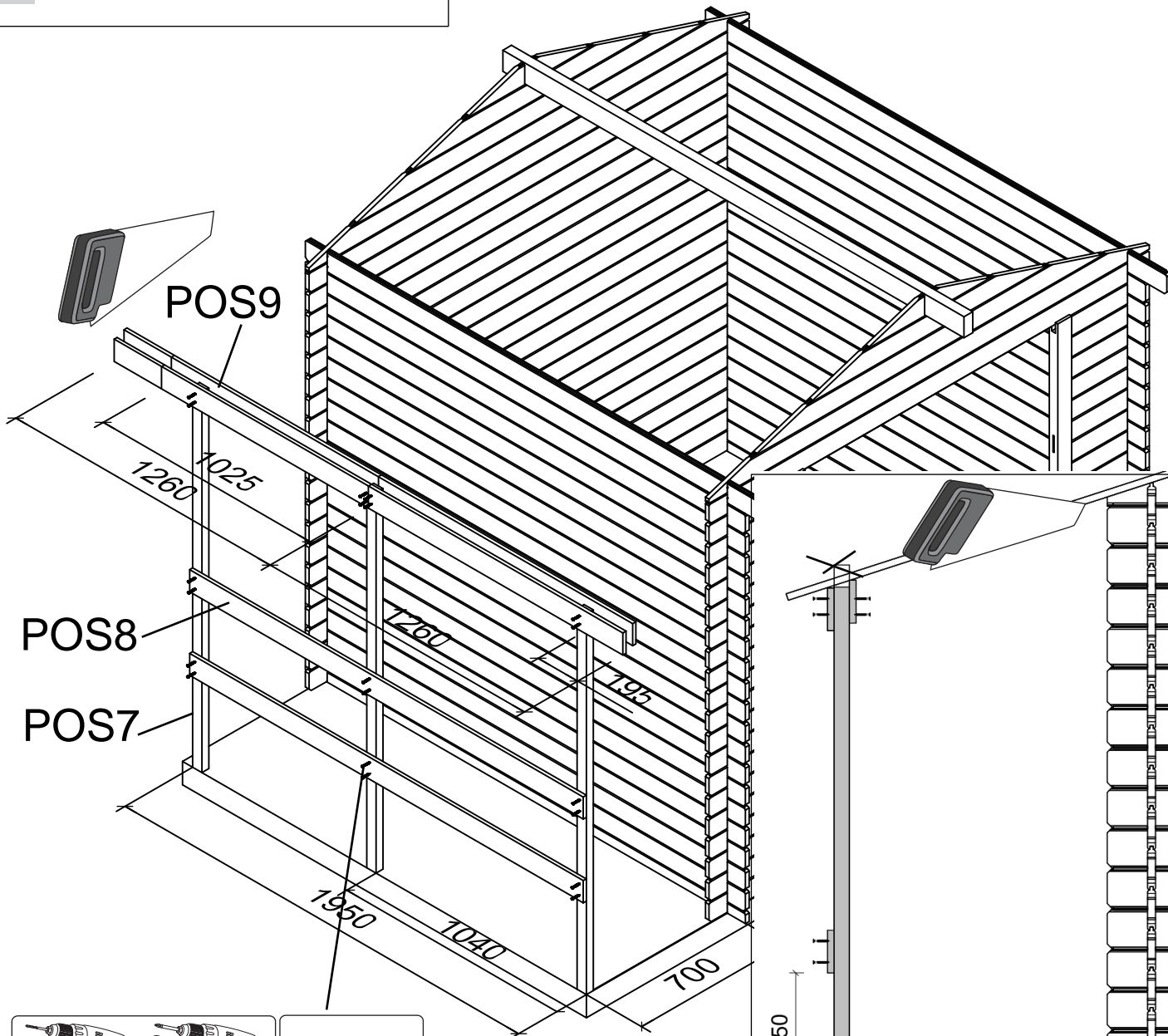
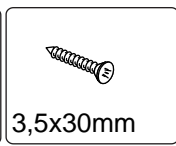
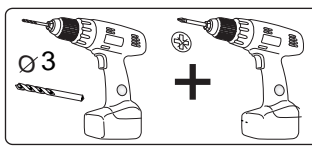

9

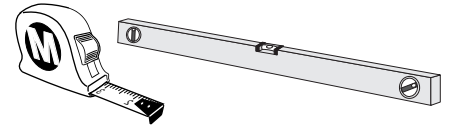

POS

10



12x571x1890 4X

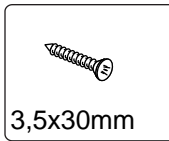

60x

11



12x571x1220 4X

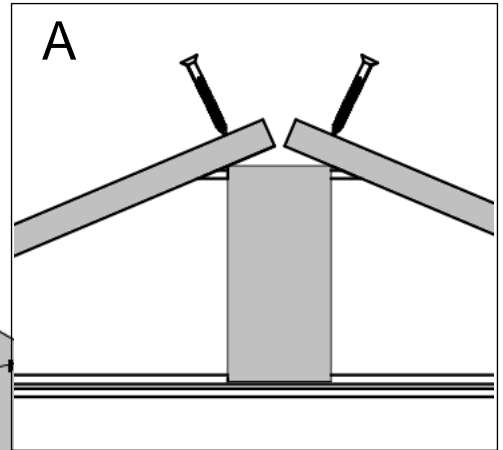
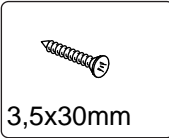
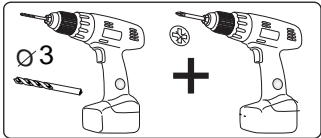

POS11

POS10

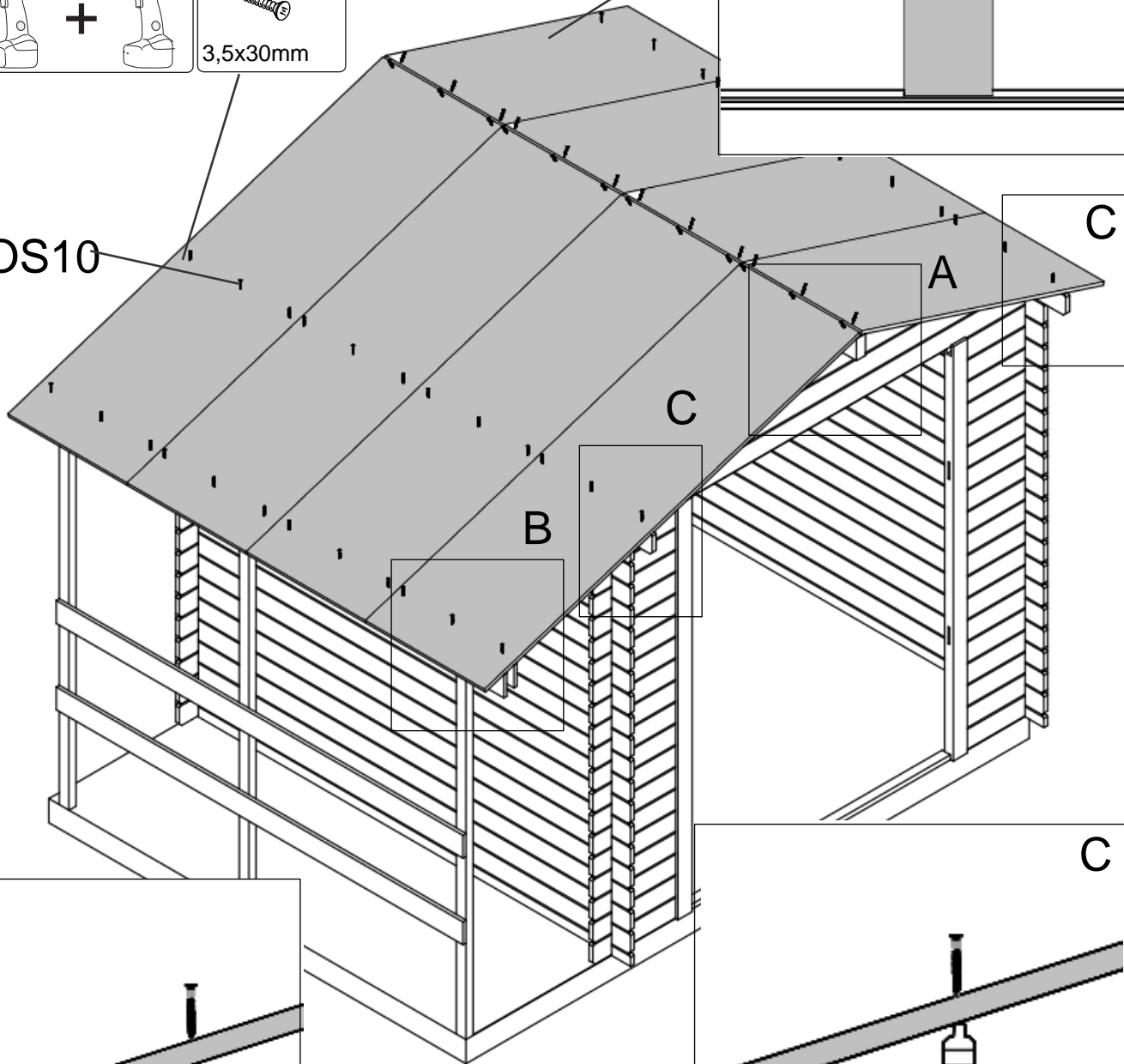

C

A

C

B

B

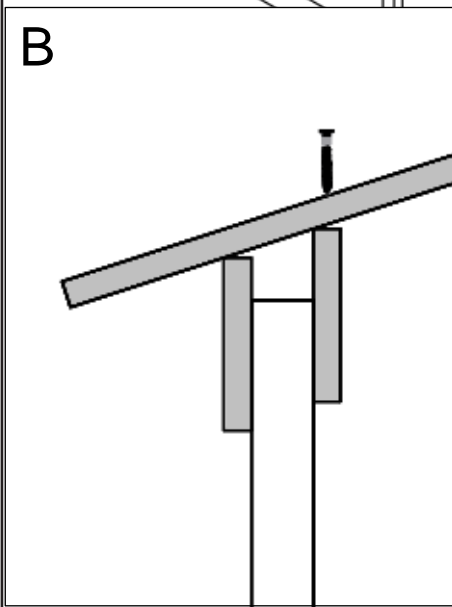

C

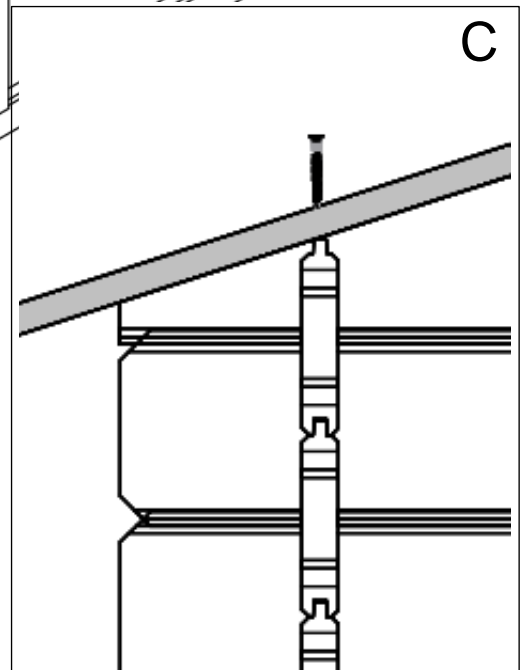

10

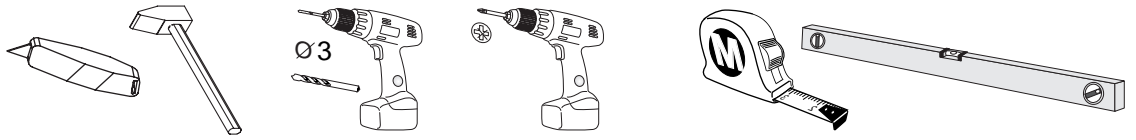

POS

16



12x26x1140 4X



3,5x25mm

12x



∅ 2x16

180x

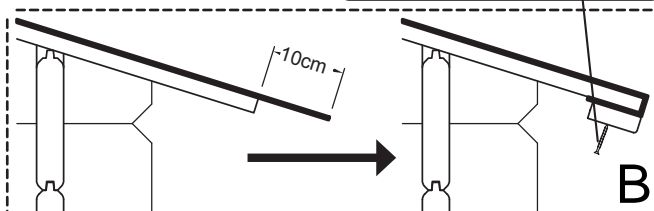
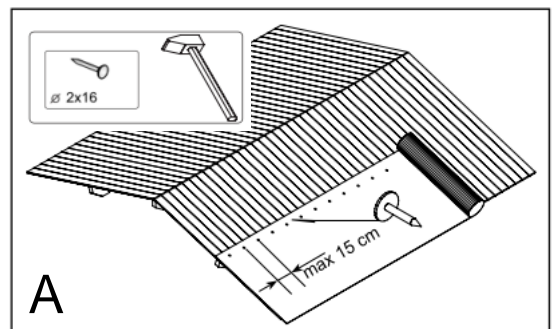
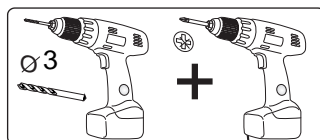
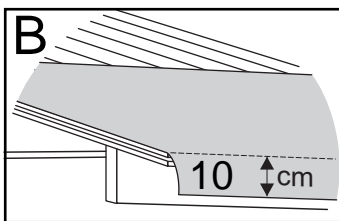
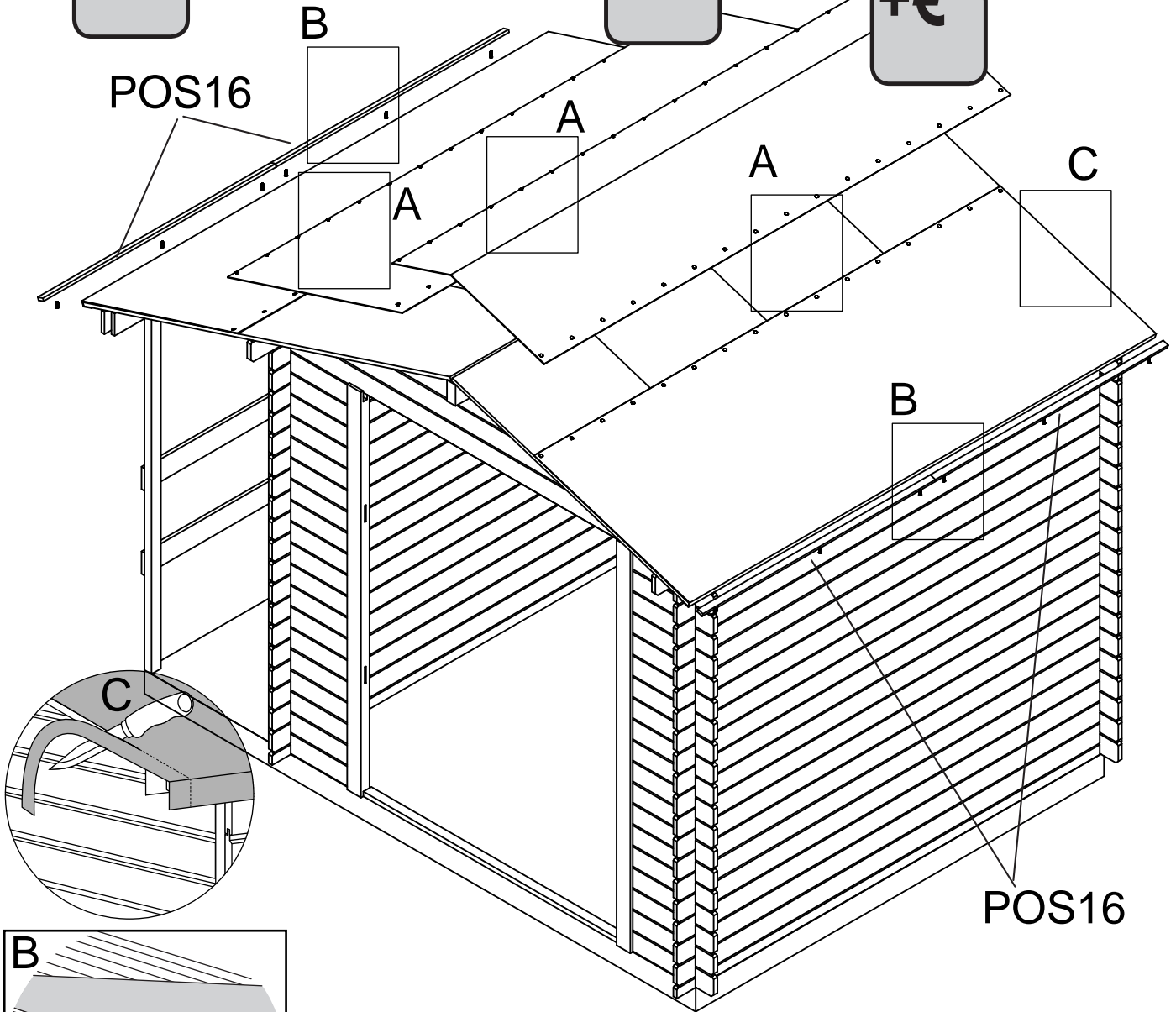
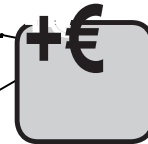
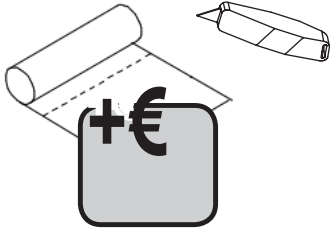
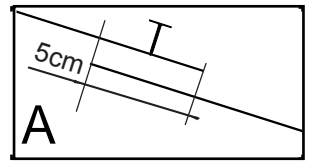

11

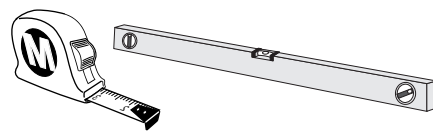
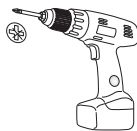

POS 17

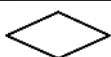

2X

12  15x95x1920 2X

13  15x95x1260 2X

14  12x26x1920 2X

15  12x26x1260 2X

 12x  
3,5x25mm

 24x  
3,5x30mm

A-B

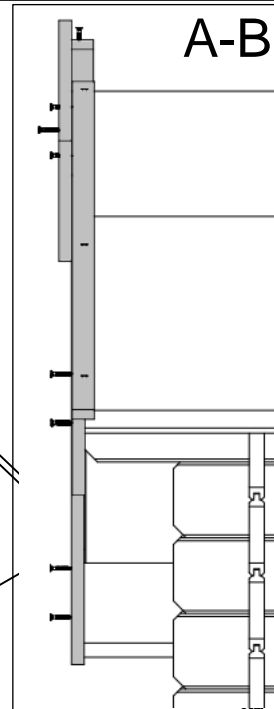

B

A

B

A

B

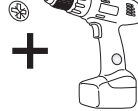
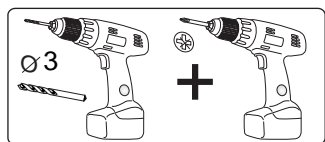

 3,5x25mm

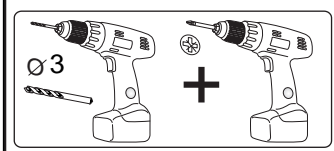
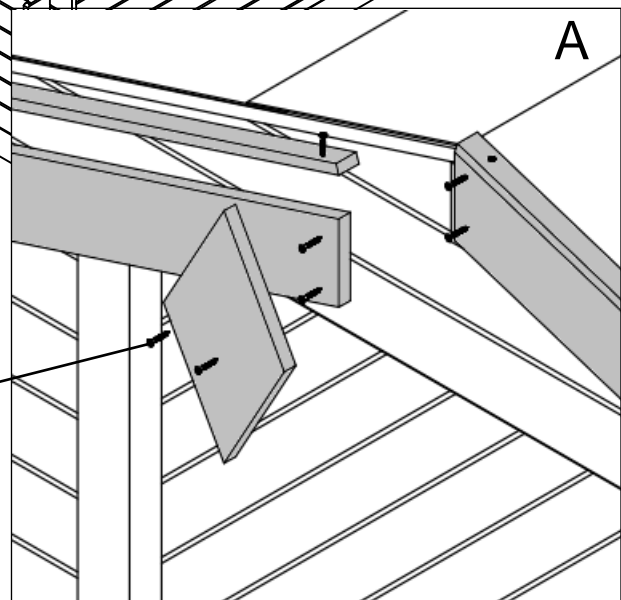
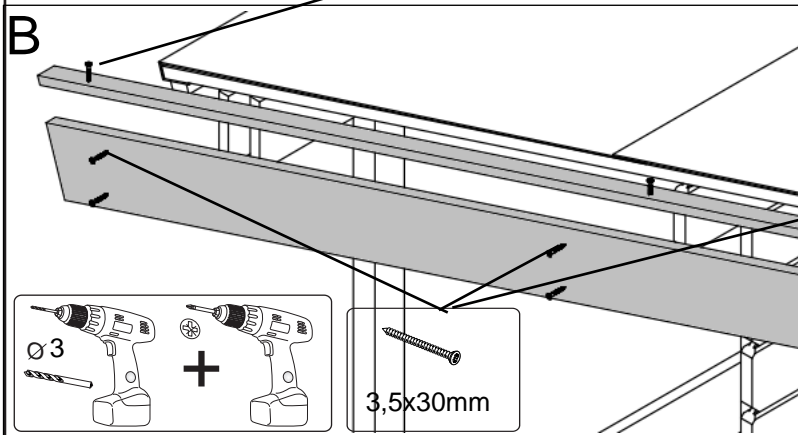

 3,5x30mm



12

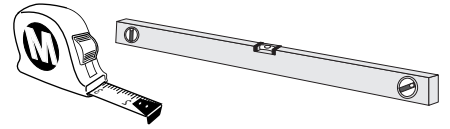
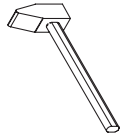

POS

21. 620x1710 zü 1X

25. 18X38X485 4X

34x  
3,5x25mm

22. 620x1710 z 1X

26. 15X25X673 2X

23. 2X435X659 2X

27. 15X25X445 2X

8x  
Ø 7x1,6x30mm

24. 18X38X712 4X

28. 12X42X1740 2X

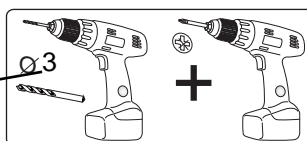
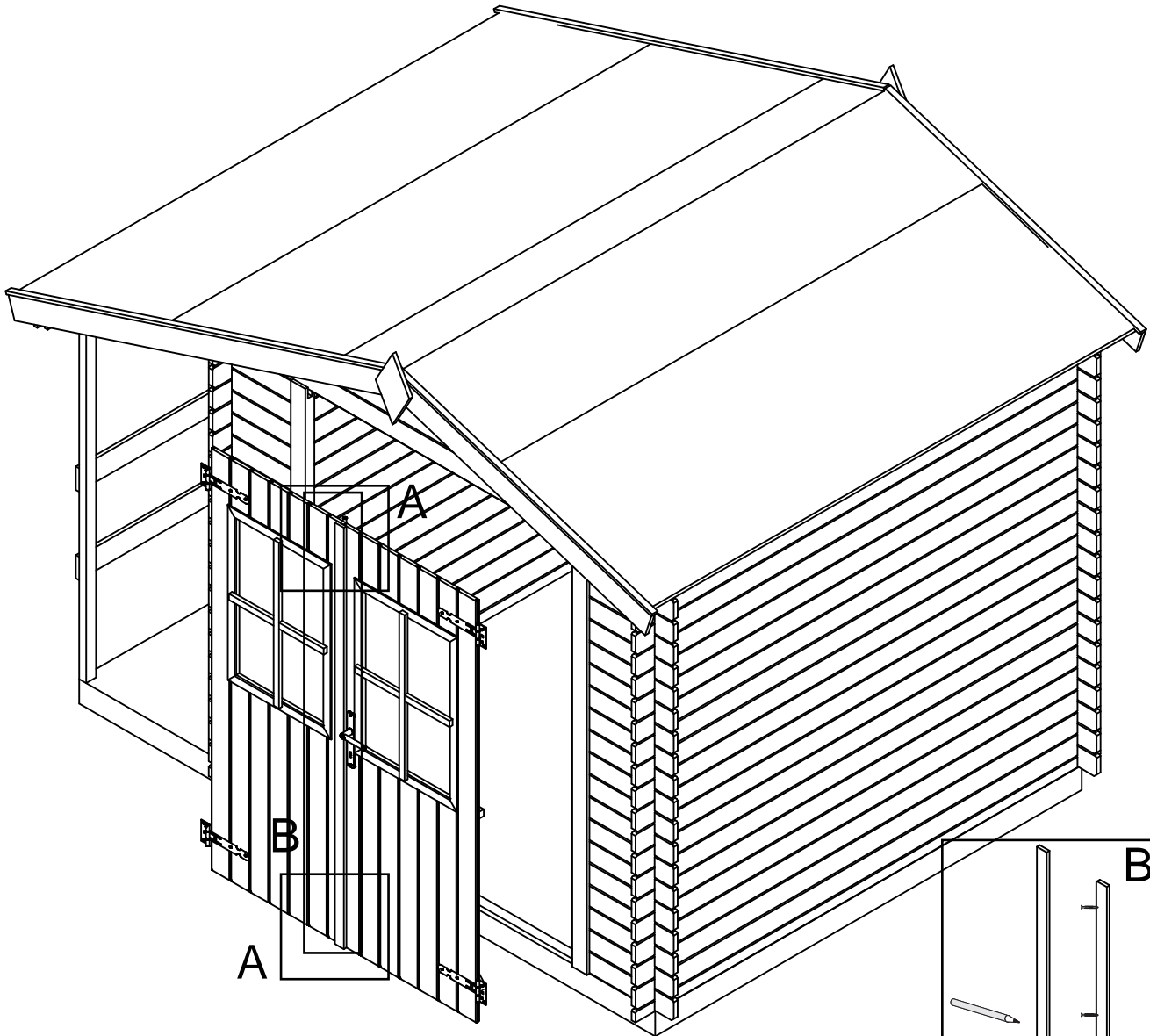

+

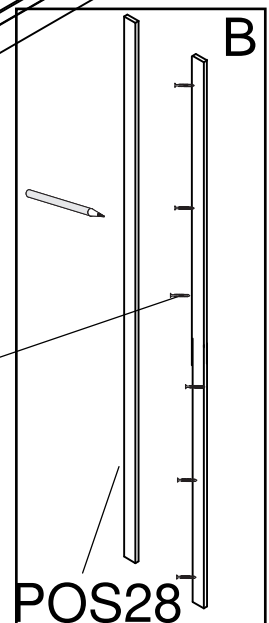
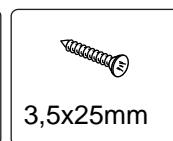

13

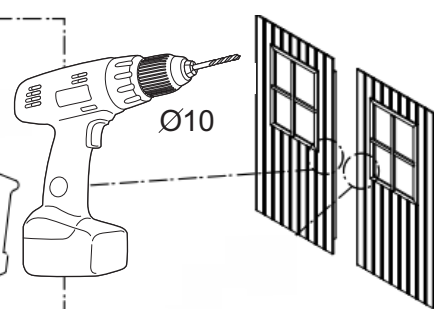
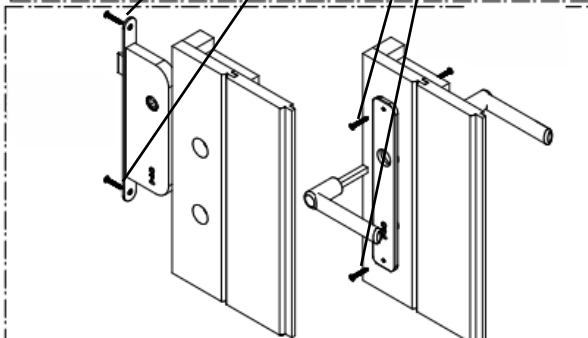
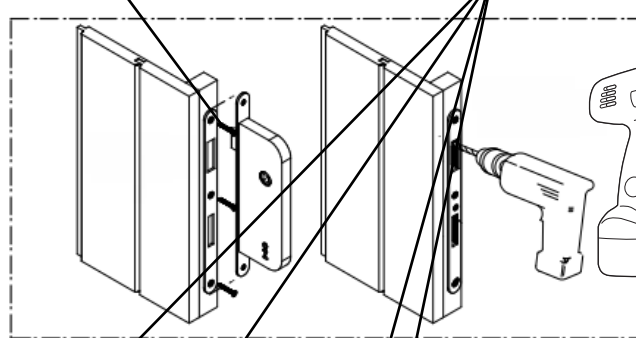
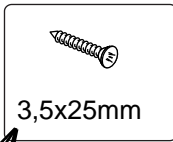
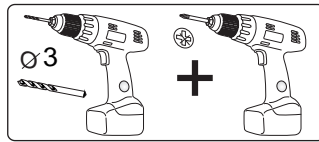
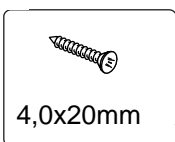
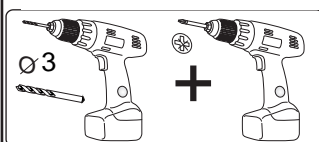
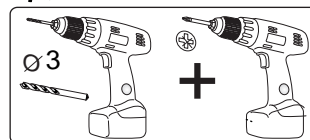
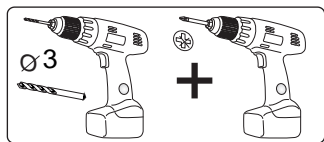
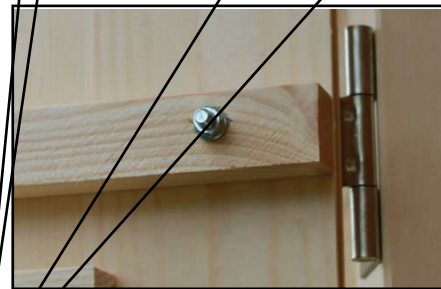
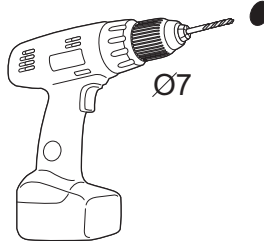
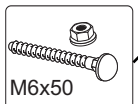
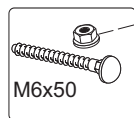
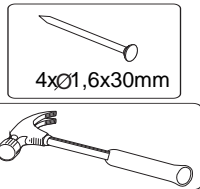
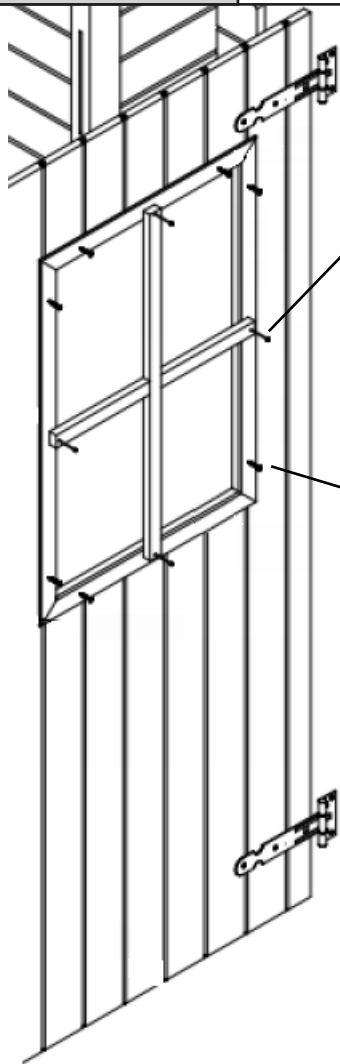
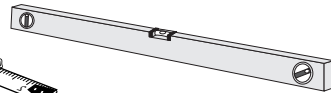
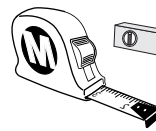
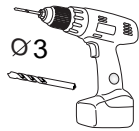
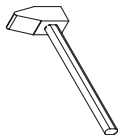

14

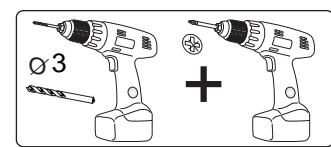
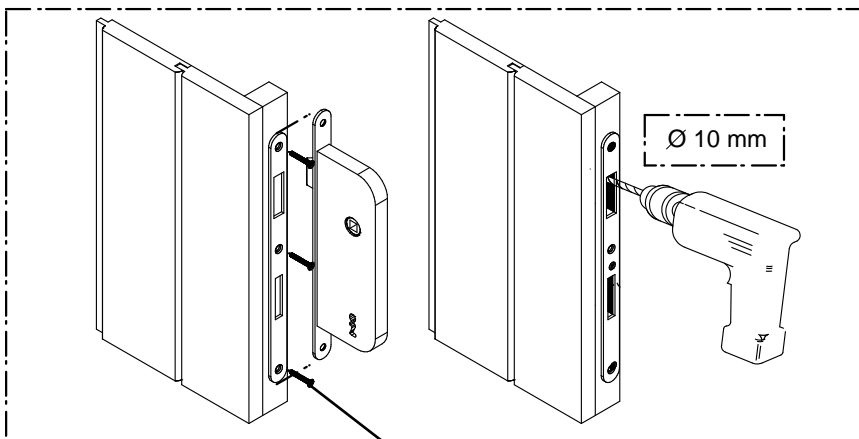
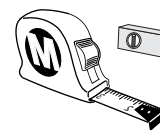
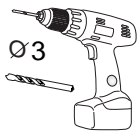

+

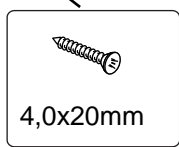

4,0x20mm

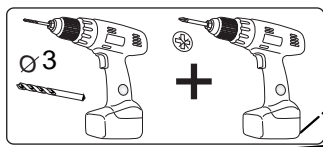

+

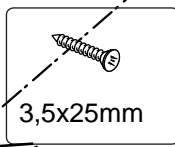

3,5x25mm

