

FLFM(NF/GR)

V.3

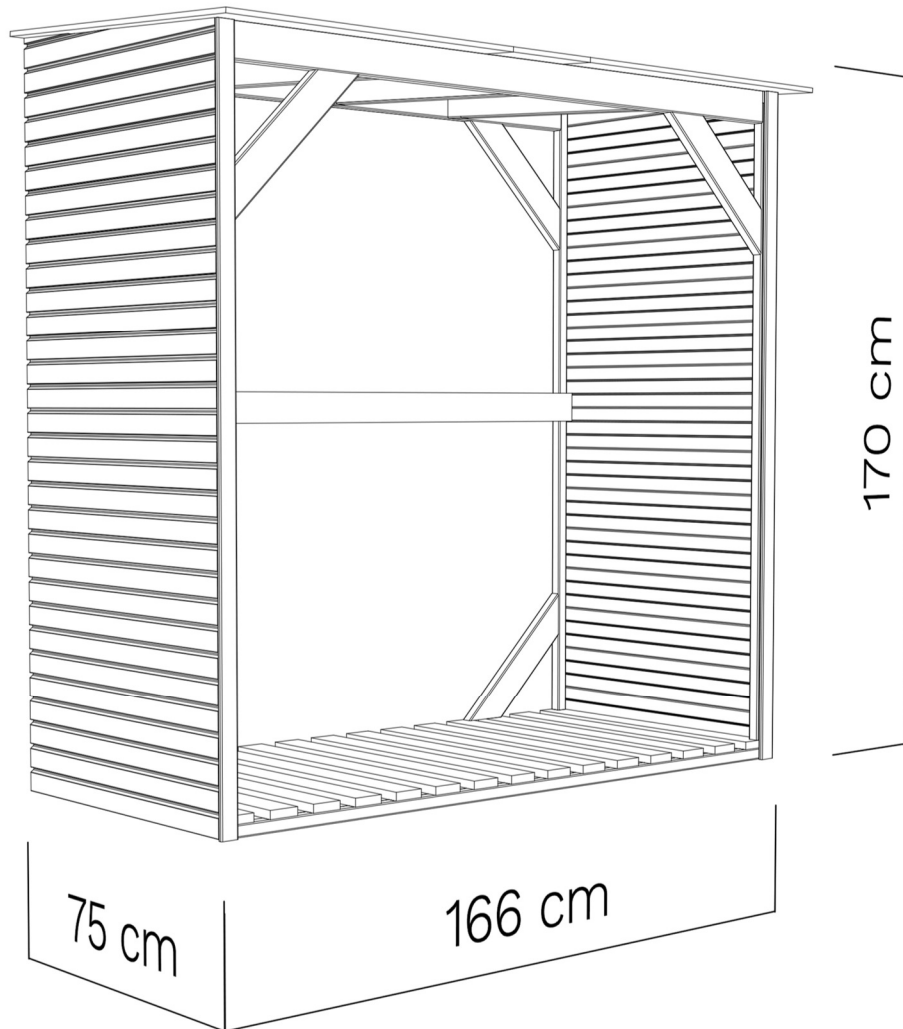

DE - Technische Änderungen vorbehalten.

Alle Maße sind ca. Maße.

EN - Technical modifications reserved.

All dimensions are approximate dimensions.

FLFM(NF/GR)

DE **Bevor Sie beginnen**

• Es ist empfehlenswert sich etwas Zeit zu nehmen, um die Aufbauanleitung anzusehen, bevor mit dem Aufbau begonnen wird. • Alle Schritte für den Aufbau werden – auch in Detailbildern – dargestellt. • Die vorgegebene Reihenfolge ist zu beachten. • Bitte prüfen Sie vor dem Aufbau anhand der Teileliste die Vollständigkeit und den Zustand der Lieferung. • Besonders wichtig ist der Holzschutz! Die Boden-elemente sind vor dem Aufbau von unten mit einem geeigneten Holzschutz zu behandeln! • Das für die meisten Produkte online verfügbare Datenblatt bietet weitere wichtige Hinweise für den Aufbau. • Beigefügt sind auch die Garantiebedingungen.

FR **Avant de commencer**

• il est recommandé de prendre le temps de lire les instructions de montage avant de commencer. • Toutes les étapes du montage sont présentées, y compris sur des illustrations détaillées. • L'ordre prescrit doit être respecté. • Avant le montage, vérifiez l'exhaustivité et l'état de la livraison à l'aide de la liste des pièces. • La protection du bois est particulièrement importante! Avant le montage, les éléments de plancher doivent être traités par le bas avec un produit de protection du bois approprié! • La fiche technique disponible en ligne pour la plupart des produits fournit d'autres informations importantes pour le montage. • Les conditions de garantie y sont également jointes.

CZ **Než začnete**

• Dporučujeme, abyste si vzali trochu času k prohlédnutí montážního návodu, než s montáží začnete. • Všechny montážní kroky jsou zobrazeny - také na podrobných obrázcích. • Je nutné dodržovat uvedený postup. • Před montáží zkontrolujte podle seznamu dílů, zda jste obdrželi všechny díly a zda je dodávka v dobrém stavu. • Obzvláště důležitá je dřevěná botka! Podlahové prvky musí být před montáží zespoda ošetřeny vhodným ochranným přípravkem na dřevo! • Datový list, který je k dispozici online pro většinu produktů, poskytuje další důležité pokyny k montáži. • V příloze naleznete také záruční podmínky.

DK **Før du starter**

• Det kan anbefales at tage sig tid til at kigge på samlevejledningen, før du starter samlingen. • Alle trin i samlingen bliver vist – også i detaljerede billeder. • Overhold den angivne rækkefølge. • Kontrollér, at leveringen er fuldstændig og i den rette tilstand ved hjælp af delelisten, før du starter samlingen. • Særligt vigtig er træbeskyttelsen! Gulvelementerne skal behandles med egnede træbeskyttelse nedefra, før du starter samlingen! • Til de fleste produkter kan du finde datablade online, der indeholder yderligere vigtige informationer til samlingen. • Garantibetingelserne er også vedlagt.

NL **Voordat u begint**

• Het is aan te bevelen om de tijd te nemen om de opbouwhandleiding door te nemen voordat er met het opbouwen wordt begonnen. • Alle stappen voor het opbouwen worden - ook met gedetailleerde afbeeldingen - weergegeven. • Neem de aangegeven volgorde in acht. • Controleer voor het opbouwen aan de hand van de onderdelenlijst de volledigheid en de hoedanigheid van de levering. • Bijzonder belangrijk is de bescherming van het hout! De vloerelementen moeten voor het opbouwen van anderen met een geschikt houtbeschermingsmiddel worden behandeld! • Het voor de meeste producten online beschikbare gegevensblad bevat verdere belangrijke aanwijzingen voor de opbouw. • Bijgevoegd zijn ook de garantiebepalingen.

PL **Przed rozpoczęciem**

• Wskazane jest, aby przed przystąpieniem do montażu zapoznać się z instrukcją montażu. • Pokazane są wszystkie etapy montażu – również na szczegółowych zdjęciach. • Należy przestrzegać podanej kolejności. • Przed montażem należy skorzystać z listy części, aby sprawdzić, czy dostawa jest kompletna i w dobrym stanie. • Ochrona drewna jest szczególnie ważna! Przed montażem elementy podłogowe należy zabezpieczyć od dołu odpowiednim środkiem do konserwacji drewna! • Arkusz danych, który jest dostępny online dla większości produktów, zawiera dalsze ważne informacje dotyczące montażu. • Załączone są również warunki gwarancji.

SV **Innan du börjar**

• Vi rekommenderar att du åsidosätter lite tid för att titta igenom monteringsanvisningen innan du påbörjar monteringen. • Alla monteringsstegen visas – även med detaljerade bilder. • Den angivna ordningen måste följas. • Kontrollera att leveransen är komplett och i gott skick innan monteringen påbörjas med hjälp av listan över delar. • Träskyddet är av yttersta vikt! Golvelementen ska behandlas underifrån med lämpligt träskyddsmedel före monteringen! • Annan viktig information före montering finns i databladet (tillgängligt online för de flesta produkter). • Garantivillkoren bifogas också.

RO **Înainte să începeți**

• Vă recomandăm să dedicați puțin timp pentru a consulta Instrucțiunile de asamblare înainte de a începe asamblarea. • Toate etapele de asamblare sunt prezentate amănunțit - și în forma unor figuri detaliate. • Respectați ordinea specificată. • Înainte de asamblare, vă rugăm să verificați lista de componente pentru a vă asigura că furnitura este completă și în stare bună. • Acordați o deosebită atenție protecției lemnului! Elementele de podea trebuie tratate de dedesubt cu o substanță conservantă adecvată pentru protecția lemnului înainte de asamblare! • Fișa de date, care este disponibilă și online pentru majoritatea produselor, oferă informații suplimentare importante cu privire la asamblare. • Atașat veți găsi și condițiile de garanție.











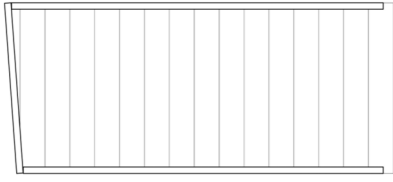
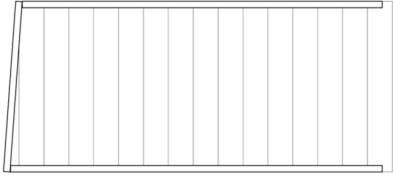
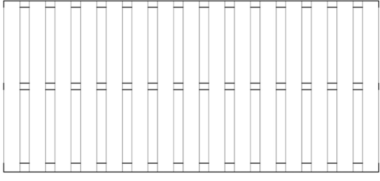

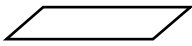

EE **Soovitused enne paigalduse alustamist**

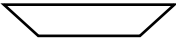
• Soovitame enne paigalduse alustamist võtta aega ja tutvuda paigaldusjuhendiga. • Kõik kokkupaneku etapid on näidatud ka üksikasjalikel piltidel. • Paigaldustööd tuleks teha etteantud järjekorras. • Enne paigalduse alustamist kontrollige detailide nimekirja alusel, kas kõik elemendid on olemas ja ega need pole kahjustada saanud. • Puidukaitse on eriti oluline! Põrandaelemente tuleb enne kokkupanekut töödelda altpoolt sobiva puidukaitsevahendiga! • Andmeleht, mis on enamiku toodete kohta internetis saadaval, pakub kokkupanekuks täiendavat olulist teavet. • Lisatud on ka garantiitingimused.

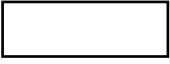
EN **Before assembly**

• We recommend that time is taken to read the assembly instructions prior to assembly. • All assembly steps are shown – also in detailed images. • The step-by-step instructions must be followed. • Before assembly, please use the parts list to check that all components are accounted for and in good condition. • Wood protection is particularly important! The floor elements must be treated from below with a suitable wood preservative before assembly! • The data sheet, which is available online for most products, offers further important information for assembly. • The guarantee conditions are also attached.

FLFM(NF/GR)

zID	Details in mm (Tolerance/Toleranz ...+ 2mm)	Pcs.	ID	Details in mm (Tolerance/Toleranz ...+ 2mm)	Pcs.
385	45 x 740 x 1686 	x 1	386	45 x 740 x 1686 	x 1
387	45 x 740 x 1625 	x 1	692	12 x 750 x 830 	2
678	12 x 230 x 830 Roof panel 	x 1	1217	28 x 80 x 1569 	x 2
1218	28 x 80 x 691  	x 2	1163	28 x 80 x 370  	x 6
1219	18 x 70 x 1625 	x 1	1220	12 x 42 x 1635 	x 2
1501	Ø4,5 x 90 	x 40	1502	Ø4,5 x 70 	x 6
1505	Ø4,5 x 50 	x 10	1506	Ø3,5 x 35 	x 40

FLFM(NF/GR)

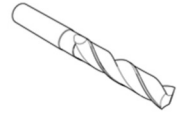
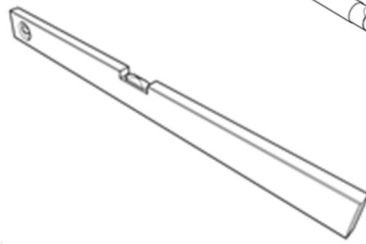
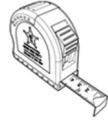
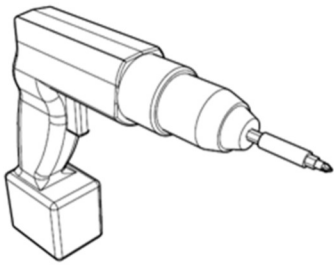

Ø 4 mm

1.

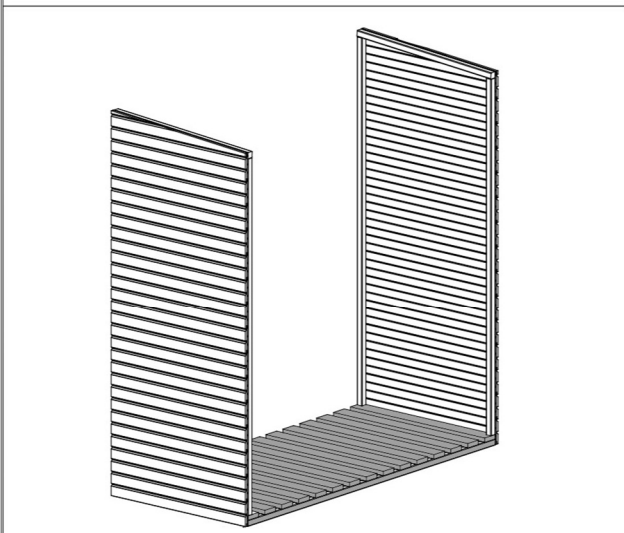
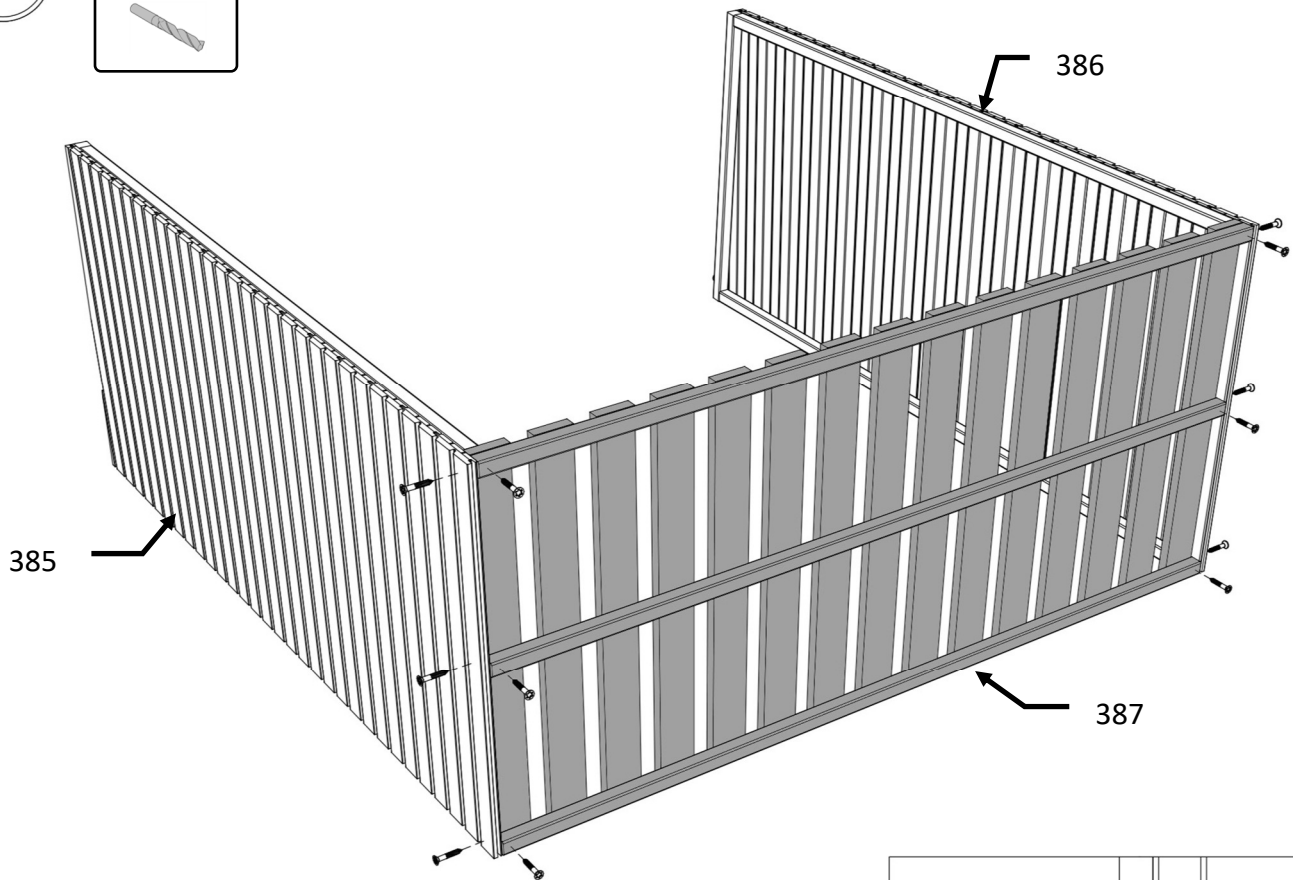
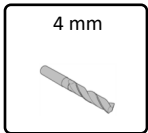

50 mm x 6 St



70 mm x 6 St



FLFM(NF/GR)

2.

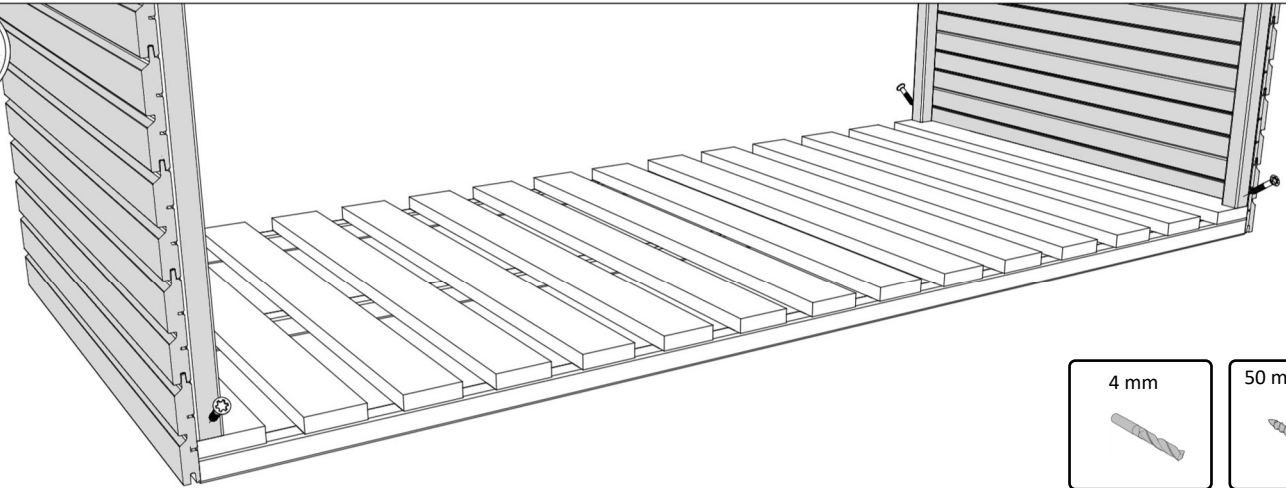

4 mm



50 mm x 4 St



3.

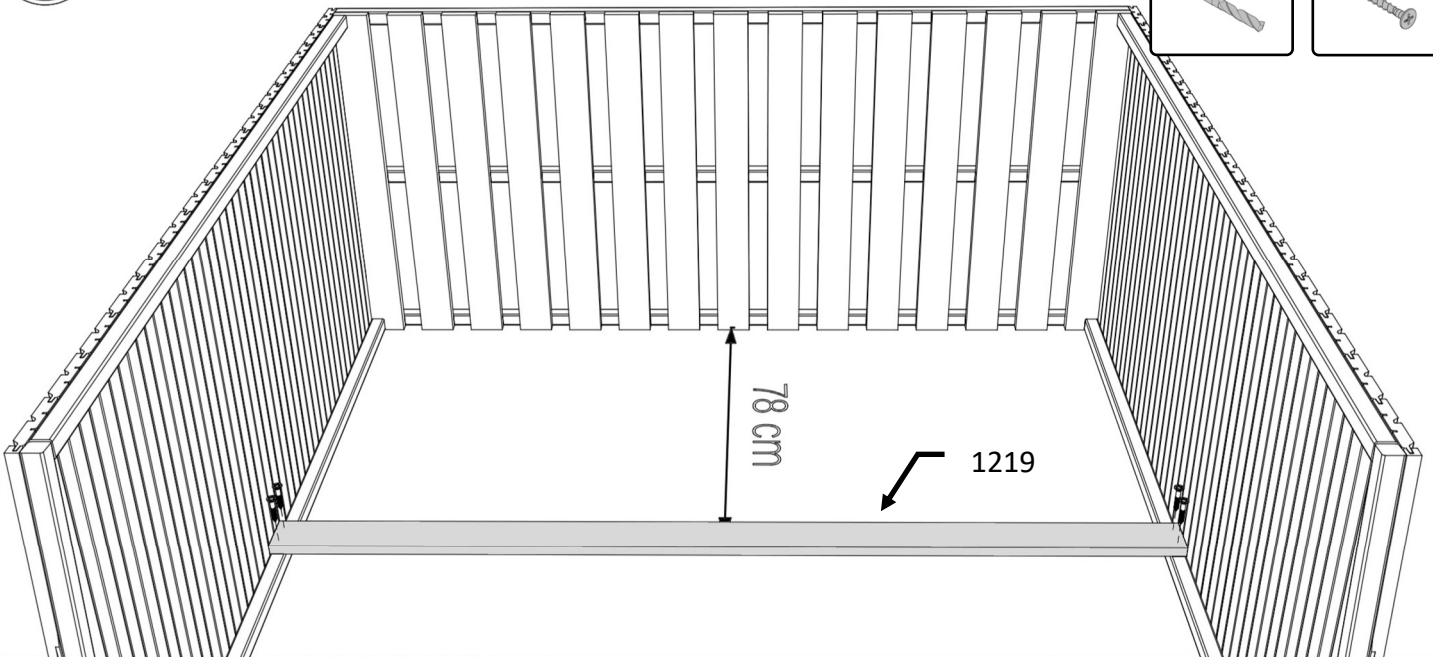

4 mm



35 mm x 4 St



4.

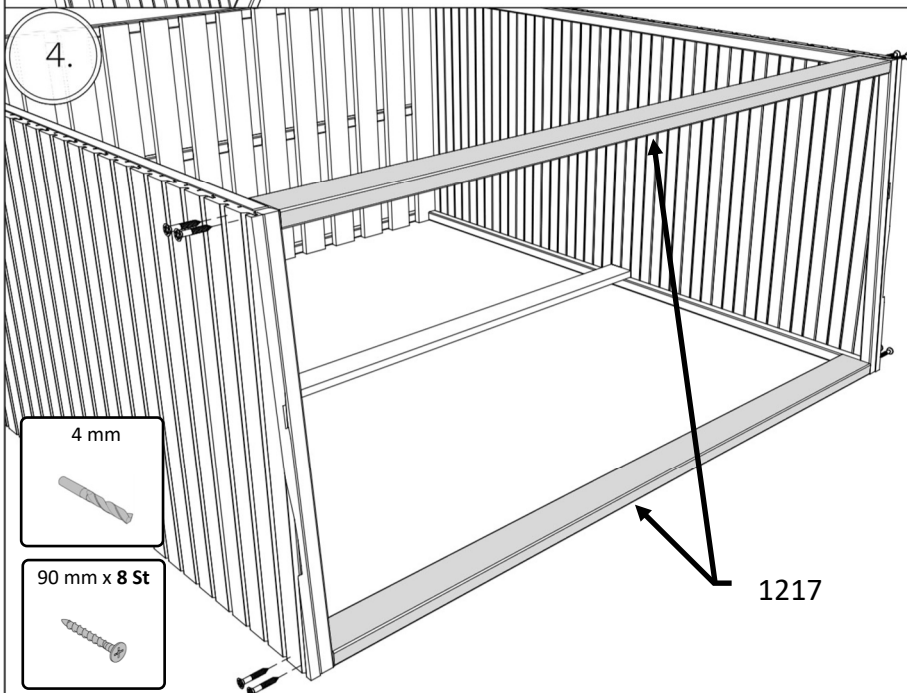

4 mm



90 mm x 8 St



1217

4.1

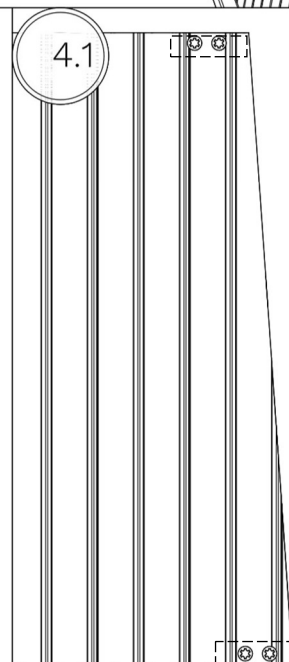

FLFM(NF/GR)

5.

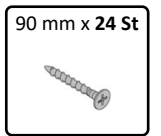
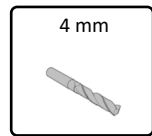
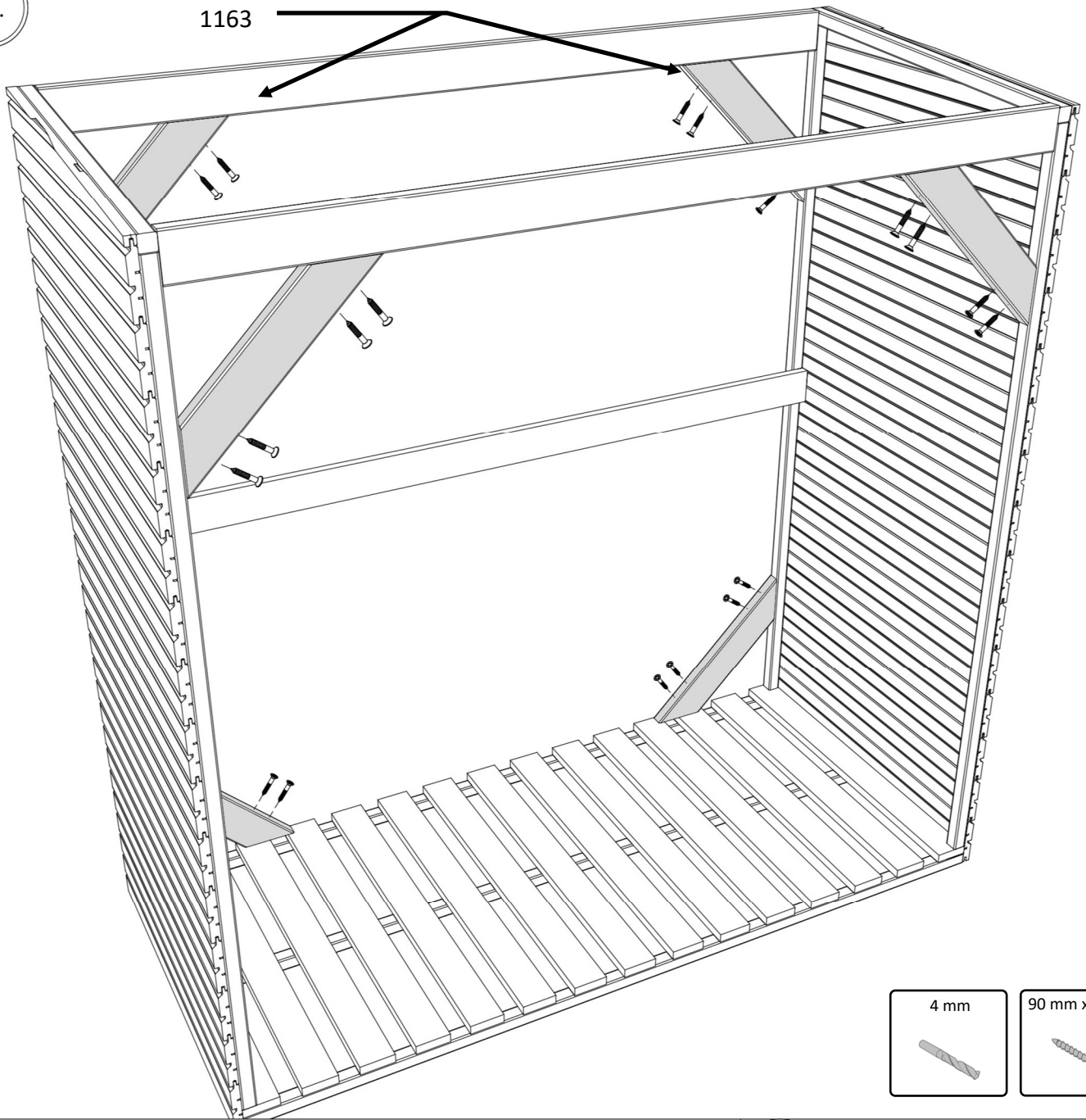

6.

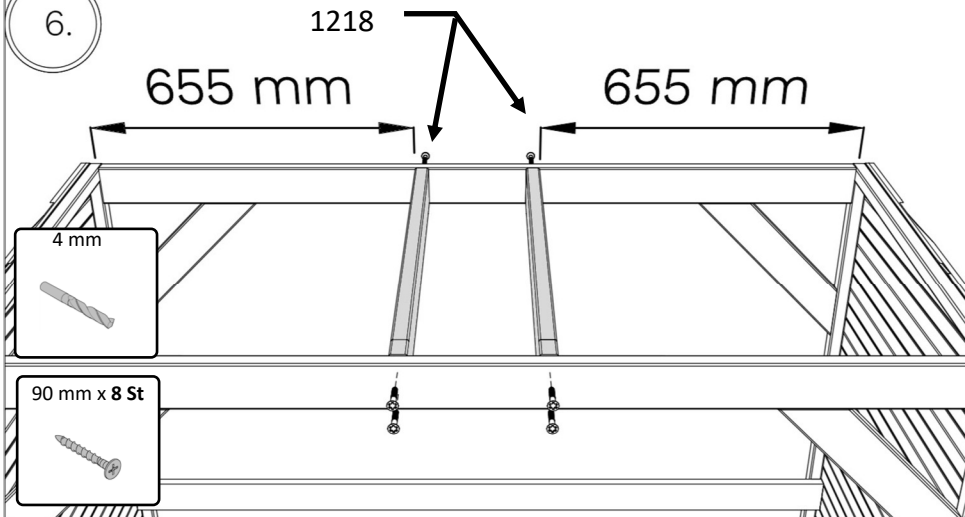

6.1

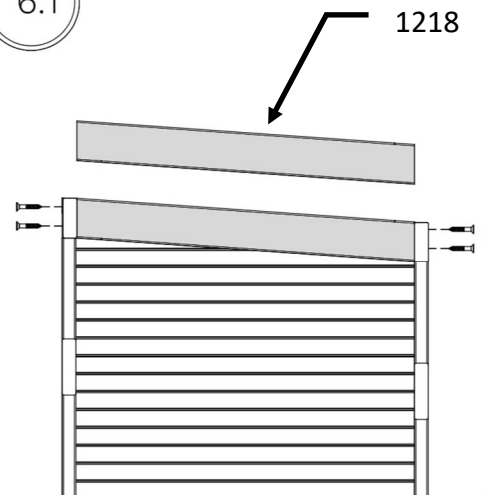

FLFM(NF/GR)

7.

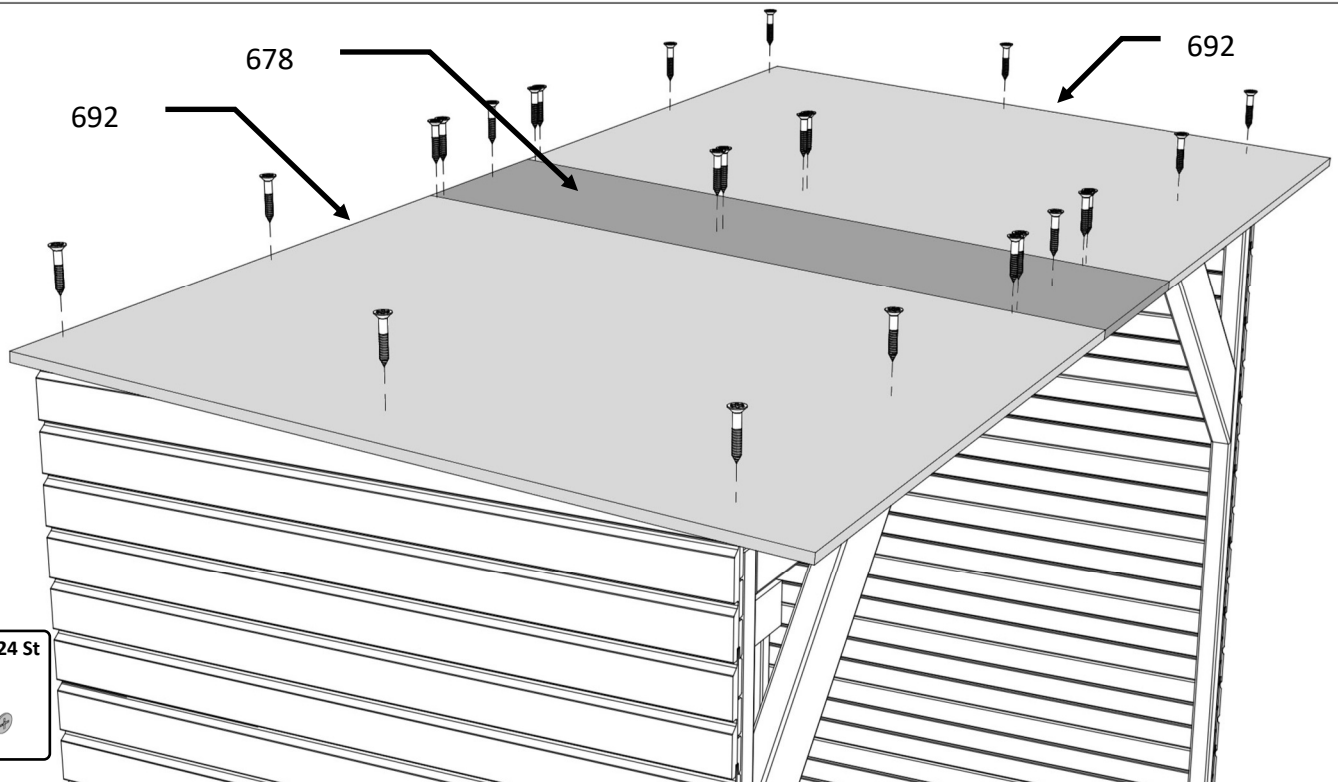

7.1

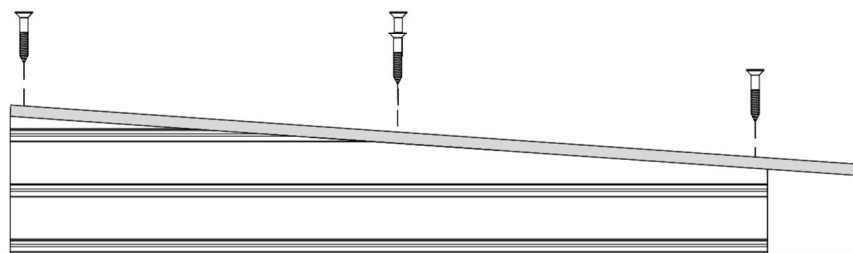

8.

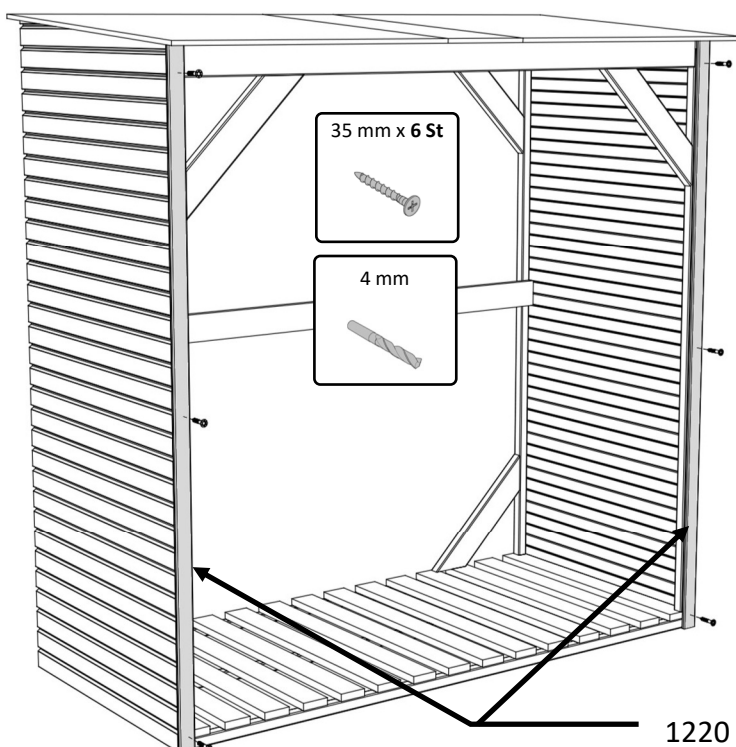

9.*

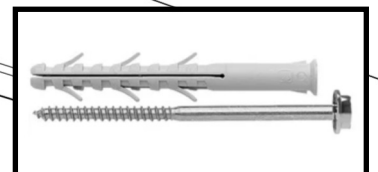

Schraube zur Befestigung an der Wand erforderlich.
(Nicht im Lieferumfang enthalten!)
Screw needed for fixing too wall. **(*Not included!)**