

Gallery Electric Fireplaces

Homeowner's Installation Instructions & Operating Manual



Model: GE-50, GE-58, GE-70, GE-94

FOR YOUR SAFETY

SERVICE MUST BE PERFORMED BY A QUALIFIED SERVICE AGENCY.

**DO NOT STORE OR USE GASOLINE OR OTHER FLAMMABLE VAPORS
AND LIQUIDS IN THE VICINITY OF THIS OR ANY OTHER APPLIANCE.**

PLEASE READ THIS MANUAL BEFORE INSTALLING AND USING APPLIANCE.

DO NOT DISCARD THIS MANUAL

SAVE THESE INSTRUCTIONS FOR FUTURE REFERENCE.

IMPORTANT INSTRUCTIONS

When using electrical appliances, basic precautions should always be followed to reduce the risk of fire, electrical shock, and injury including the following:

1. Read all instructions before using this appliance.
2. This appliance is hot when in use. To avoid burns, do not let bare skin touch hot surfaces. Keep combustible materials, such as furniture, pillows, bedding, papers, clothes and curtains at least 3 feet (0.9m) from the front of this appliance.
WARNING: In order to avoid overheating, do not cover the heater. Do not install in small enclosed spaces.
3. CAUTION: Whenever the heater is left operating and unattended, extreme caution is necessary if children are nearby.
4. The appliance is not be used by children or others, unless they have been given supervision or instruction.
5. Children should be supervised to ensure that they do not play with the appliance.
6. If possible, always unplug this appliance when not in use.
7. Do not operate any heater with a damaged cord or plug, after an appliance malfunction, or if it has been dropped or damaged in any manner.
8. If the power cord is damaged, it must be replaced by the manufacturer, its service agent or similarly qualified persons in order to avoid a hazard.
9. Any repairs to this fireplace should be carried out by a qualified service person.
10. Under no circumstances should this fireplace be modified. Parts which have been removed for service must be replaced prior to operating this fireplace again.
11. Do not use outdoors.
12. This heater is not intended for use in bathrooms, laundry areas and similar indoor locations. Never locate this appliance where it may fall into a bathtub or other water container.
13. Do not run cord under carpeting. Do not cover cord with throw rugs, runners or the like. Arrange cord away from traffic areas and where it will not be tripped over.
14. To disconnect this appliance, turn controls to the off position, then remove plug from outlet.
15. Connect to properly grounded outlets only.
16. This appliance, when installed, must be electrically grounded in accordance with local codes or, in the absence of local codes, with the current CSA C22.1 Canadian Electrical Code or for U.S.A installations, follow local codes and the National Electrical Code, ANSI/NFPA NO.70.
17. There is a thermostat limiter inside the heater. When the inner temperature over-heats or abnormal heating occurs, the thermostat protective device will cut-off the power supply to avoid damage to the fireplace or risk of fire.
18. Do not insert or allow foreign objects to enter any ventilation or exhaust opening as this may cause an electric shock, fire, or damage the appliance.
19. To prevent a possible fire, do not block air intakes or exhaust in any manner. Do not use on soft surfaces, such as beds or carpeting where opening may become blocked.
20. This appliance has hot and arcing or sparking parts inside. Do not use it in areas where gasoline, paint or flammable liquids are used or stored. This fireplace should not be used as a drying rack for clothing. Christmas stockings or decorations should not be hung in the area of it.
21. Use this appliance only as described in the manual. Any other use not recommended by the manufacturer may cause fire, electric shock or injury.
22. Avoid the use of an extension cord because the extension cord may overheat and cause risk of fire. However, if you have to use an extension cord, the cord must be No.14 AWG minimum size and rated not less than 1875 Watts. The extension cord must be a three wire cord with grounding type plug and cord connection. The extension cord shall not be more than 20 feet (6m) in length.
23. See directions in Figure 1.
This heater is to be used on a 110 / 120 V, 15 AMP, grounded circuit. Do not use in an outlet controlled by a switch or dimmer switch. The cord supplied with the heater, has a 3-prong plug, the round pin on the plug is for grounding purposes. If a 3 slot receptacle is not available, an adapter must be used, and the adapter must be properly grounded to the outlet box. Avoid plugging other appliances into the same circuit as heater.

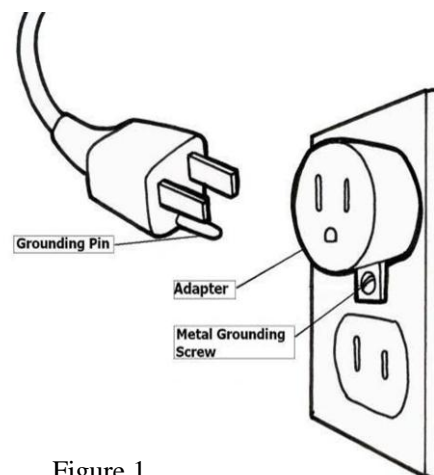
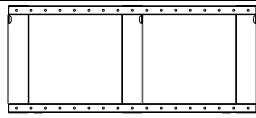
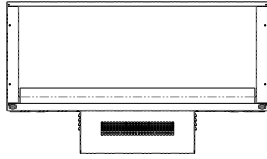
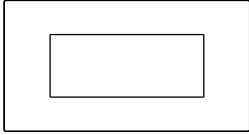

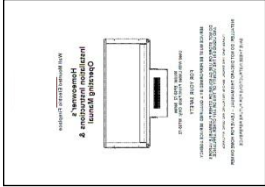



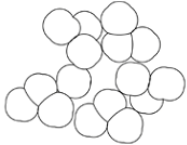

Figure 1

INSTALLATION INSTRUCTIONS

PACKAGE CONTENTS

| Part | Description | Qty | Picture | Additional Info |
|------|--------------------------|-------|--|--|
| 1 | Wall Mounting Bracket | 1 |  | |
| 2 | Fire Box with Heater | 1 |  | |
| 3 | Fireplace Front | 1 |  | |
| 4 | Remote Control | 1 |  | |
| 5 | Battery | 2 |  | |
| 6 | Instruction Manual | 1 |  | |
| 7 | Plastic Wall Anchor Plug | |  | 6pcs for GE-50/58 8pcs for GE-70/94 |
| 8 | Screw ST5x40 | |  | 6pcs for GE-50/58 8pcs for GE-70/94 |
| 9 | Bolt M5x10 | 2 |  | |
| 10 | White Stones | 1 bag |  | |
| 11 | Clear Resin Faux Stones | 1 bag |  | |

TOOLS REQUIRED

Magnetic Phillips Screw Driver
Electric drill or hammer drill (for concrete walls)

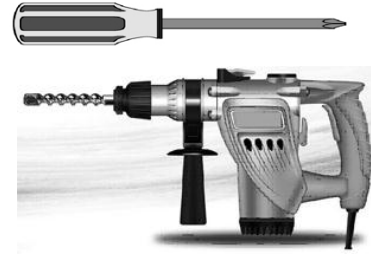

UNPACKING THE ELECTRIC FIREPLACE



WARNING! Do NOT use this Electric Fireplace if any part has been under water. Immediately call a qualified service technician to inspect and to replace any part of the electrical system if necessary. Keep plastic wrapping away from children.

- Open the packaging carefully and remove the foam.
- Remove and discard the plastic bag.
- Keep the original packaging for future transport and/or storage.
- Check that all listed parts have been included before discarding any packaging.

LOCATING YOUR ELECTRIC FIREPLACE

Your new electric fireplace may be installed virtually anywhere in your home. However, when choosing a location ensure that the general instructions and warnings are followed. For best results, install out of direct sunlight. Power supply service should be configured before finishing to avoid extra construction.

WARNING ! Keep drapery and other furnishings at least 3ft /0.9m from the front and sides of the electric fireplace.

Clearance to Combustibles

Sides2 in. (50 mm)
Floor13 3/4 in. (350 mm)
Top 0 in. (0 mm)
Back 0 in. (0 mm)

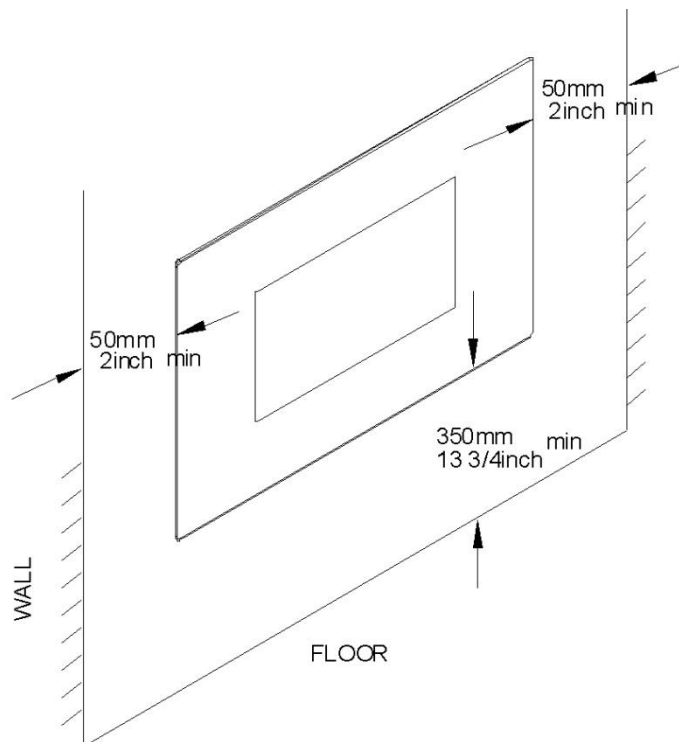

Figure 2

INSTALLING YOUR FIREPLACE

Wall mounting bracket installation:

1. Open the box and take out the wall mounting bracket.
2. Choose a solid and plain wall and put the bracket in the position where you want to install the fireplace. Mark the holes with a pen (6 for GE-50/58, 8 for GE-70/94) using the holes in the mounting bracket as a guide (Fig. 3)
3. If locating the fireplace on existing wall studs or solid wood walls, Screws can be inserted at this time and you can proceed to step 6, otherwise continue the steps below for placing wall anchors.
4. Take away the bracket and then, using an 8mm or 1/4" drill bit, drill holes in the wall. Put the plastic wall anchors into the holes. (Fig. 4)
5. Insert ST5x40 screws to secure the bracket to wall (Fig. 5)

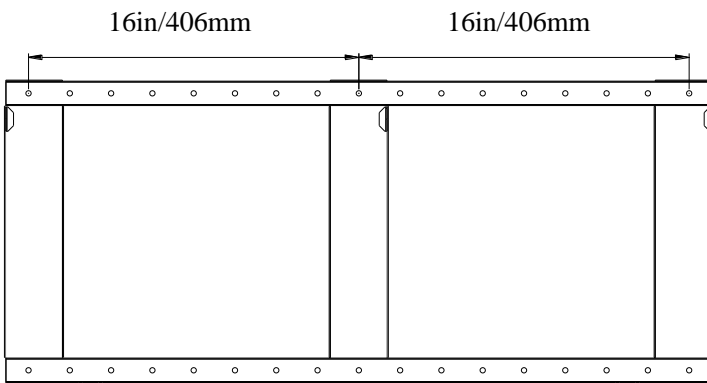

Fig. 3

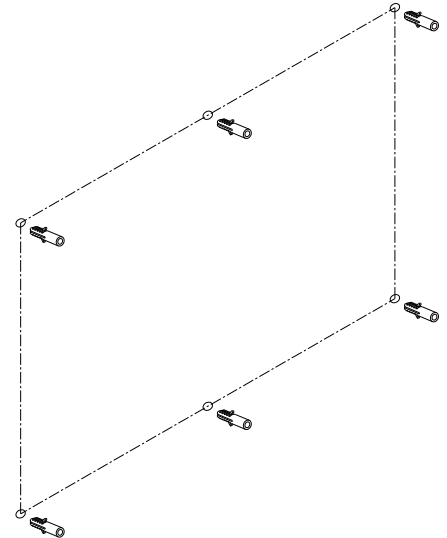

Fig. 4

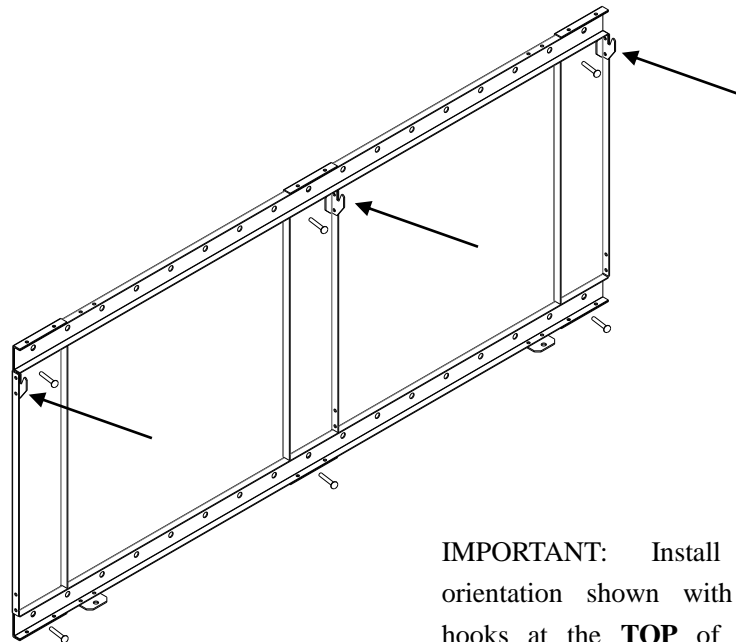

Fig. 5

IMPORTANT: Install in the orientation shown with mounting hooks at the **TOP** of bracket as shown by arrows

6. Hang the fireplace on the hooks at top and push the fireplace into the bracket and then insert the short M5x10 screws into the bottom support tabs. (Fig. 6)
7. Arrange the white & clear faux stones along the inset window ledge at the front of the firebox.
8. Install the fireplace front as pictured. (Fig. 7) Secure the fireplace front with 2 M4x8 screws in the tabs on top of the fire box
9. Connect the backlighting cable at the bottom of the glass to that of the fire box (Fig. 8, Fig.9,)

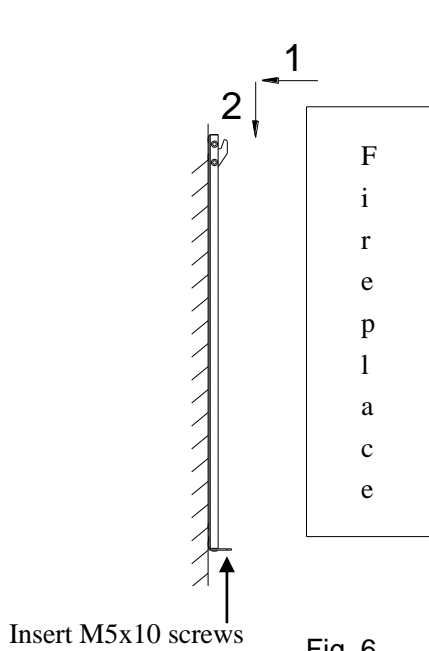

Fig. 6

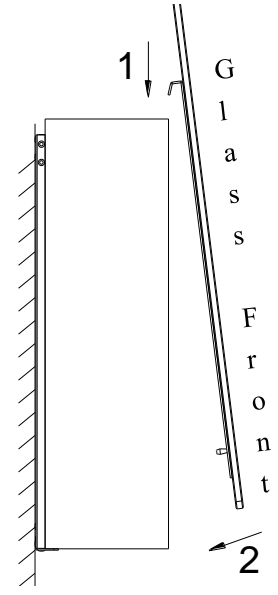

Fig. 7

On underside of fire box, remove the screws holding access panel on. Pull long cord out and thread through hole in access panel. Replace access panel when finished.

Connect cord to front LED lighting plug and tuck cords behind glass.



Fig. 8

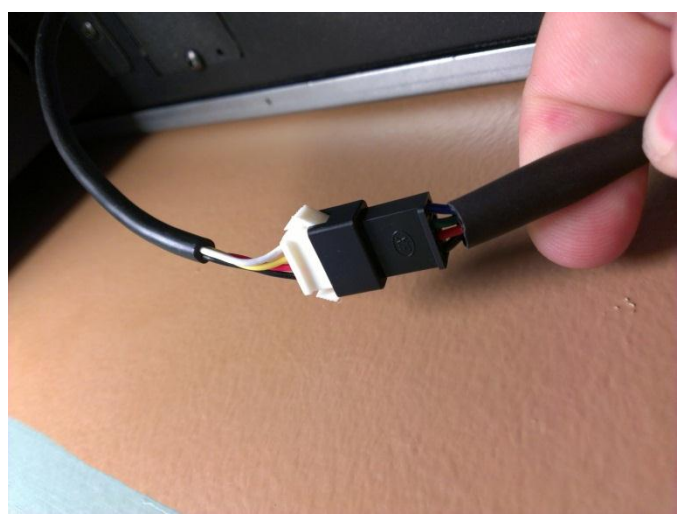

Fig. 9

ELECTRICAL CONNECTION

A 15 AMP, 120 Volt, 60 Hz circuit with a properly grounded outlet is required. The unit comes standard with 6 feet (1.8 m) three wire cord, exiting from the rear of the fireplace. Plan the installation to avoid the use of an extension cord. Preferably, the fireplace will be on a dedicated circuit as other appliances on the same circuit may cause the circuit breaker to trip or the fuse to blow when the heater is in operation.

CLEANING TRIM

Clean the glass trim using a soft cloth and household glass cleaner and buff with a clean soft cloth if streaking occurs.

MAINTENANCE

WARNING: ALWAYS UNPLUG THE CORD BEFORE MOVING OR SERVICING.

DO NOT IMMERSE HEATER IN WATER!

- Always turn OFF the heater and disconnect the cord from the electrical outlet before cleaning your heater.
- Light accumulated dust may be removed from the heater with a soft cloth or vacuum cleaner.
- Wipe the exterior surfaces of the heater occasionally with a slightly damp cloth (not dripping wet) using a solution of mild detergent and water. Dry the case thoroughly before operating the heater.

Caution: Do not allow water to run into the interior of the heater as this could create a fire or electric shock hazard.

- The fan motor is factory lubricated for life and will not require further lubrication.

Warning: Any other servicing needed must be performed by an authorized service representative. Do not attempt to service the unit yourself.

OPERATING INSTRUCTIONS: REMOTE CONTROL FUNCTIONS

This appliance can be operated by both remote control and manual buttons located on the side of the fire box. Once the unit has been properly connected to a grounded electrical outlet, turn on the main power switch located on the right-hand side of the appliance. A beep should be heard when the power is first switched on.

 **CAUTION!** The unit's power cord must be connected to a properly grounded and protected 120V outlet. Always use ground fault protection where required by the electrical code.

 **WARNING!** Do not operate the unit if it is damaged or has malfunctioned. If you suspect the unit is damaged, please call a qualified service technician to inspect and to replace any part of the electrical system if necessary.

NOTE! To use both remote and manual function the main power switch must be in "ON" position.

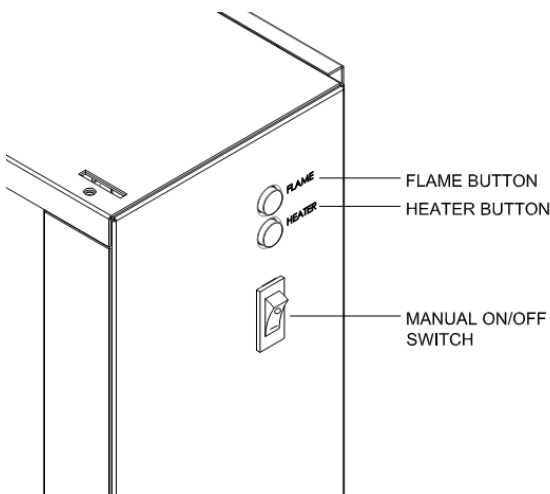

• Operating by Manual Button

MANUAL ON/OFF SWITCH

This switch turns heater on/off, and permits / prohibits use of remote and panel push buttons.

FLAME BUTTON







The fire has four flame effects, by pressing the flame effect button the unit will cycle through each effect.

HEATER BUTTON

Press once turns 750W power on. (Pilot lights illuminated ●○)
 Press again turns 1500W power on (Pilot lights illuminated ●●)
 Press third time turns heater off. (Pilot lights illuminated ○○)

• Operating by Remote Handset

- Make sure the battery are installed properly in the remote control.
- The effective range of the remote control is up to 4 meters or 13 feet.

| ICON | TITLE | FUNCTION |
|---|------------|--|
|  | POWER | Press once turns appliance on. Press again turns appliance off. |
|  | FLAME | The fire has four flame effects, by pressing the flame effect button the unit will cycle through each effect. |
|  | HEATER | Press once turns 750W power on. (Pilot lights illuminated ●○) Press again turns 1500W power on (Pilot lights illuminated ●●) Press third time turns heater off. (Pilot lights illuminated ○○) |
|  | TEMP | Digital display shows the TEMP setting 23°C (73°F) (default), with 14 settings circle from "OFF", "16°C" to "28°C" (61°F to 82°F). The TEMP will increase by 1°C/F up to 28°C(82°F) when pressed each time. By pressing the TEMP for 3S, the digital display can switch between °C and °F. |
|  | TIMER | Cycles from OFF, 0.5H, 1H, 2H, 3H, 4H, 5H, 6H, 7H, 8H, to 9H. |
|  | BACK LIGHT | By pressing the backlight button the unit will cycle through 12 Colors, a color-cycle mode, and OFF setting. |

WARRANTY

In the unlikely event of a problem occurring due to a manufacturing fault within 24 months from the date of purchase of the appliance it will be repaired or replaced free of charge.

This warranty does not cover consumable items such as the bulbs and fuses which have a limited lifespan.

If a problem should occur, the nature of the problem together with the date of a purchase should be immediately reported to the retailer that the appliance was purchased from. Proof of purchase will be required so the original receipt should be retained.

Warranty applies to the original owner only and is non-transferrable.

TROUBLESHOOTING

| Problem | Possible Causes | Solution |
|--|--|---|
| Fireplace not responding to remote commands | Switch on fireplace not in the ON position | Switch must be in the ON position for remote operation |
| | Remote control battery dead or not inserted properly | Insert or check battery for correct orientation |
| | Remote is not in range of fireplace or not aimed correctly | Move closer to fireplace and aim remote directly at it. |
| Fireplace trips circuit breaker or blows fuse when turned on | Improper circuit rating | Ensure unit is plugged into a dedicated 15 amp circuit |
| | Too many appliances plugged into the same circuit | Unplug other appliances on the same circuit |
| Heater is excessively noisy | Blower assembly is dirty | Unplug unit and clean blower |
| | Defective blower | Blower replacement or repair necessary |
| Odor coming from heater/blower | Normal operation | Heater is burning off dust accumulated during manufacture or non-use periods. This should only be noticeable for a brief period after turning on. |
| | Defective heater | Heater may require replacement or repair |
| Flame effect frozen or stuttering | Defective flame motor | Flame motor repair or replacement required. |
| Heater not outputting heat when turned on. | Thermal switch tripped | Turn off unit and unplug for 5 minutes. This is a safety feature to prevent overheating |
| | Heater is defective | Replacement or repair may be required |
| | Thermostat is cycled off | Set thermostat to higher setting |
| LED Lighting not turning on | Front glass panel not plugged into fire box | Plug front panel in according to instructions |
| | Lighting may be defective | Repair or replacement may be required. |



For more information, you can visit us online at

[Http://www.GreatCo.com](http://www.GreatCo.com)

Or Call Us At:

1-866-303-4028