

**Manual refers to  
R2, R3, R4, R5  
CP2, CP3, CP4, CP5**

**\*\* R3, CP3 shown throughout manual \*\***

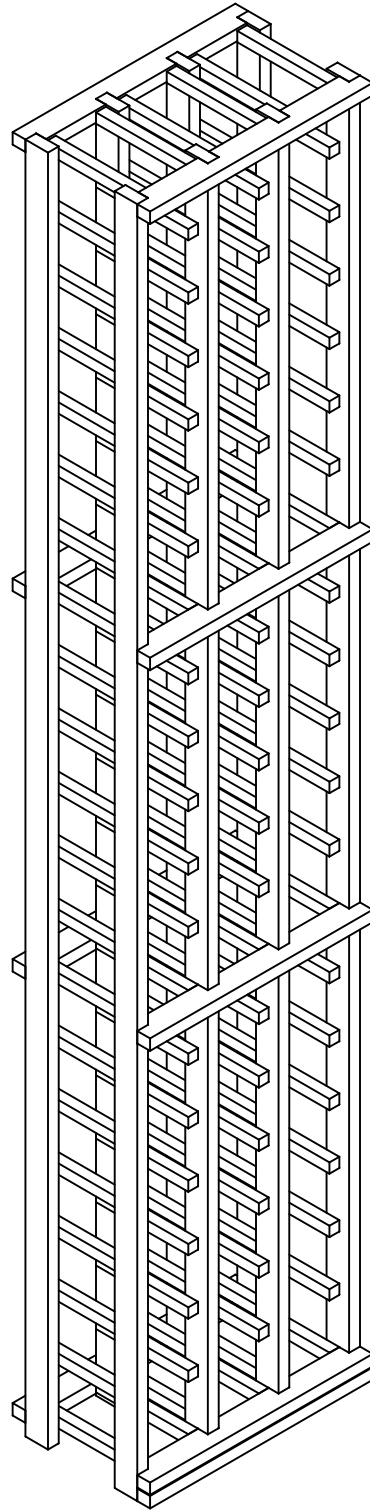

**Wine Cellar Innovations**  
4575 Eastern Avenue  
Cincinnati, Ohio 45226

Phone: (800) 229-9813  
Fax: (513) 979-5280  
[www.winecellarinnovations.com](http://www.winecellarinnovations.com)

### R2, CP2

#	Qty.	Description
A:	9	3 notch Spacer Bars
B:	2	End Racks
C:	1	Double Racks
*	1	Bag of nails
*	1	Hardware Pack containing 2 angle brackets 2 plastic anchors 2 1" #8 screws 2 3/4" #6 screws

### R3, CP3

#	Qty.	Description
A:	9	4 notch Spacer Bars
B:	2	End Racks
C:	2	Double Racks
*	1	Bag of nails
*	1	Hardware Pack containing 2 angle brackets 2 plastic anchors 2 1" #8 screws 2 3/4" #6 screws

### R4, CP4

#	Qty.	Description
A:	9	5 notch Spacer Bars
B:	2	End Racks
C:	3	Double Racks
*	1	Bag of nails
*	1	Hardware Pack containing 2 angle brackets 2 plastic anchors 2 1" #8 screws 2 3/4" #6 screws

### R5, CP5

#	Qty.	Description
A:	9	6 notch Spacer Bars
B:	2	End Racks
C:	4	Double Racks
*	1	Bag of nails
*	1	Hardware Pack containing 2 angle brackets 2 plastic anchors 2 1" #8 screws 2 3/4" #6 screws

A for R2 & CP2

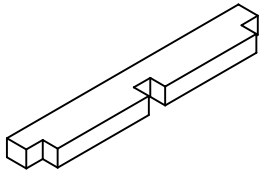

A for R3 & CP3

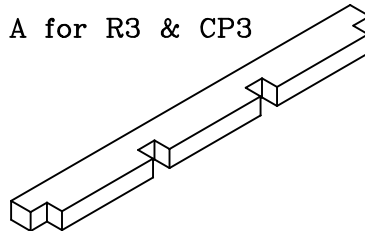

A for R4 & CP4

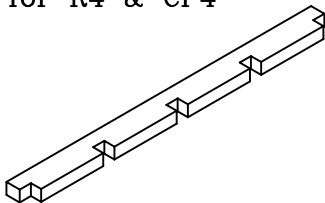

A for R5 & CP5

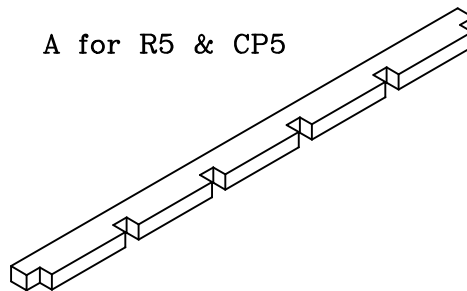

B

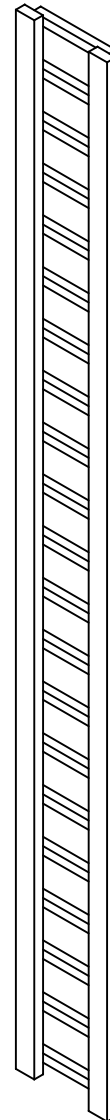

C

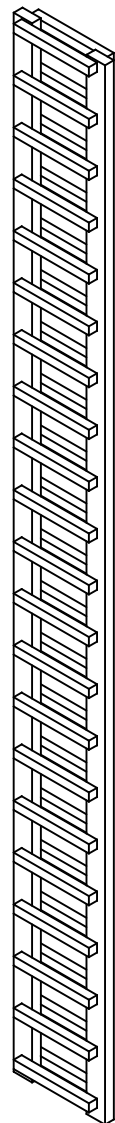

## Step 1:

- a. Place 4 spacer bars on the floor staggered with notches facing up.

This position is temporary DO NOT nail staggered Spacer bars to racks.

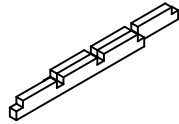
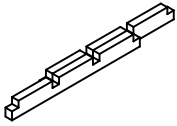

- b. Place (2) end and 1,2,3 or 4 double racks on the staggered spacer bars.

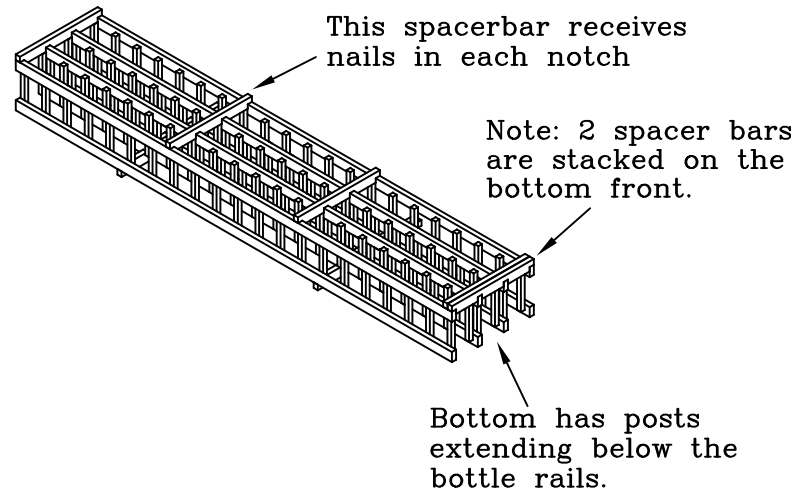

- c. Attach (5) spacer bars to racks with nails

Nail the nails into each spacer bar just on each end except the noted spacer bar above. This can be done with the provided nails or with a brad nailer.

## Step 2:

Flip rack over and nail the remaining 4 spacerbars to the racks in the same manner as step 1.

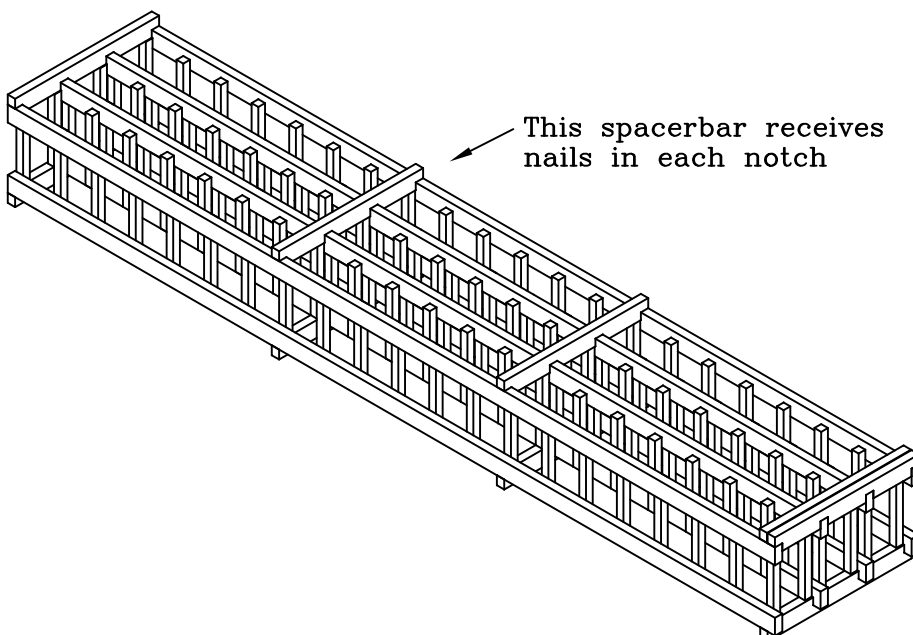

# Final Step

Securing to wall

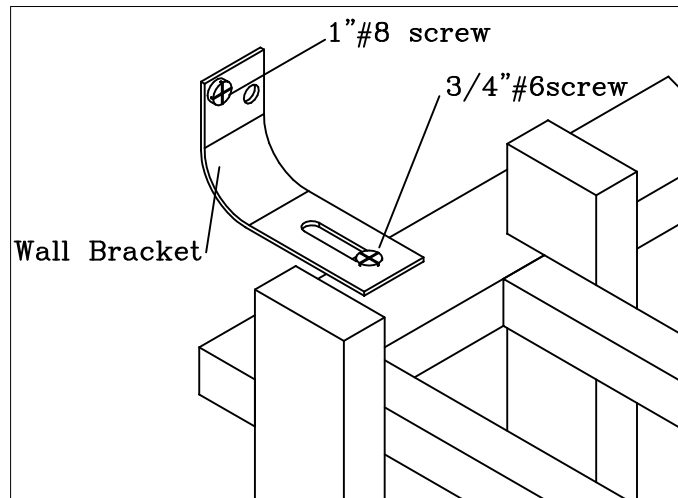

Secure rack to wall by attaching wall brackets to top back spacer bar or solid top. You will have 1 bracket on the left and 1 on the right.

Wine Rack is Complete

**Note:** Always remove bottles before moving rack.