

Owners Manual CHEST FREEZERS

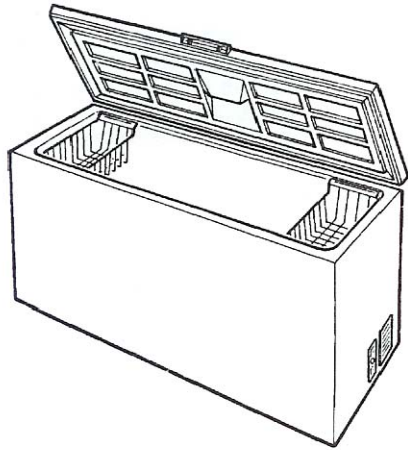

CONTENTS

Important Safety Instructions	2
If Your Electricity Goes Off	3
Installing Your Freezer	3
Installation Requirements	3
Picking a Location	3
Starting the Freezer	4
Freezer Features	4
Temperature Control	4
Cool Down Period	4
Interior Light	4
Sliding Basket	4
Power Light	5
Built-in Lock	5
Cleaning Your Freezer	6
Troubleshooting	7
Energy Saving Tips	8
Vacation & Moving Tips	8

If you need service or call with a question, have this information ready.
We advise you to keep this Owners Manual and your sales slip in your possession.

Model: _____

Serial Number: _____

Date of Purchase: _____

Guide d'utilisation - CONGÉLATEUR HORIZONTAL

Table des Matières _____ 9

Manual de instrucciones - CONGELADOR TIPO CAJÓN

Indice _____ 18

Important Safety Instructions

Warning: Risk of Child Entrapment

Never allow children to operate, play with, or crawl inside a freezer or refrigerator.

If you are *storing* a refrigerator or freezer:

1. **Block the door open:** Glue thick wooden blocks to the door so it can't close. Be sure to use strong glue and place the blocks high, out of children's reach. Leave only enough room to allow ventilation to keep appliance from collecting mildew.

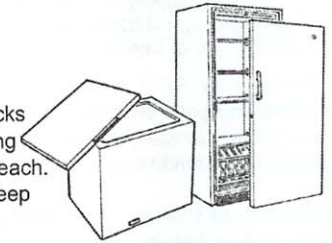

2. **Band, tape or secure the door shut:** Use strong tape and wrap it all the way around the appliance several times or pass a heavy duty chain around the appliance and through the handle(s) and then padlock it ensuring it cannot slide loose.

Before you throw away your old refrigerator or freezer:

1. **Take off the lid or door:** The hinge of chest type freezers are under spring tension. Instructions for removal of the hinges are found on the back of the freezer.

2. **Cut off any electrical wires:** Ordinary household tools are all you need.

3. **Leave the shelves in place:** so that children may not easily climb inside.

Talk to your children about the dangers of playing around or inside any container that might shut them in.

WHY all these precautions?

Each year children die because they climb inside an old refrigerator or freezer, the door closes and they are trapped inside and suffocate . . . usually in less than 10 minutes! Please take a few minutes and prevent such a needless tragedy.

If you are selling your old appliance or giving it away, put this manual inside so the new owners will know what to do when they discard or store the unit.

- Destroy carton, plastic bags, and any exterior wrapping material immediately after the freezer is unpacked. Children should never use these items for play. Cartons covered with rugs, bedspreads, plastic sheets or stretch wrap may become airtight chambers and can quickly cause suffocation.
- Extreme caution should be used when removing the lid of the freezer. The hinge of chest type freezers are under spring tension! Before attempting to remove hinges, see instruction label on the back of the cabinet.
- Do not store or use gasoline or other flammable items in the area of this or any appliance, as the fumes can create a fire hazard or explosion.
- This freezer is designed for free-standing installation only; it should not be recessed or built-in.

- Replace or repair all electric service cords that have become damaged or frayed.
- Never unplug your freezer by pulling on the power cord. Always grip plug firmly and pull straight out from the outlet.
- Be careful not to roll over or damage the cord, when moving the freezer.
- Unplug your freezer before making repairs or cleaning. It is our recommendation that servicing be done by a qualified technician.
- Unplug your freezer or turn power off at the circuit breaker or fuse box in order to avoid touching a live wire, when replacing a burned-out light bulb. Turning the control to OFF turns off the compressor, but does not disconnect power to other electrical components.
- Do not pinch, knot, or bend power cord in any manner.

If your electricity goes off follow this procedure:

- Call your power company to see how long the power will be out.
- If service is to be interrupted for less than 24 hours, keep freezer closed. This will help food stay frozen.
- If service is to be interrupted for more than 24 hours, either remove food and store in frozen food locker or another freezer.

Installing Your Freezer

Your dealer is responsible for unpacking your freezer properly. Should any evidence of mishandling be present, contact him immediately.

Installation Requirements:

- A 115 Volt, 60 Hz, AC 15 or 20 ampere fused and properly grounded electrical supply (for personal safety) is required.
- Refer to the serial plate for the correct electrical rating.
- A separate circuit used only by this appliance is recommended.
- * **DO NOT USE AN EXTENSION CORD.**
- * **DO NOT CUT, REMOVE OR BYPASS THE GROUNDING PRONG FROM THE PLUG.**
- To prevent the freezer from being turned off accidentally, do not plug unit into an outlet controlled by a wall switch or pull cord.
- If voltage varies by 10 % or more, the performance of the freezer may be affected. Operating the freezer with insufficient power can damage the motor. The warranty does not cover this damage. If you suspect your household voltage is high or low, consult your power company for testing.

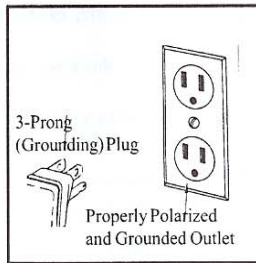

Picking a Location:

- Locate the freezer so that extension cords are not necessary and the freezer is away from any flammables such as gasoline.
- Make sure that the floor you choose to place your freezer on will support the weight of the freezer when it is full.

- Due to the lid and hinge arrangement, it is impossible to install the freezer directly against the wall. The spacing on the back is essential for maintaining proper air circulation around the freezer. It is recommended that you leave a 3 inch (75 mm) space on all sides of the freezer.
- Locate the freezer where it will be convenient to use and away from direct sunlight or heat sources such as the range, dishwasher, laundry equipment or furnace. Freezers are designed to operate efficiently between 4°C to 32°C (40°F to 90°F). Temperatures above or below this range will cause the freezer to operate less efficiently. Additional compressor heaters are not recommended
- If the place selected for your freezer is damp or moist, as in some basements, place freezer on wooden blocks. (Two or three boards under entire length will assure adequate support.)
- The freezer should never be placed on a carpeted floor.
- In order for your freezer to work properly, it must be level with the floor. If not, you may add metal or wood shims between feet pads and floor.
Note: the floor must be strong enough to support a fully loaded freezer.
- If there is tape residue on the freezer, remove with a mixture of warm water and mild detergent or touch the residue with the sticky side of tape already removed.
- **DO NOT REMOVE THE SERIAL PLATE.**

Starting the Freezer:

- The freezer is ready to operate when you receive it. Just connect the cord to the power outlet.
- Turn the temperature control knob (located at the lower right hand side of the cabinet) to No. 4. This setting is normal for providing safe long term freezing. For colder temperatures turn to a higher setting.
- NOTE: Some models have a preset temperature and no control knob.
- Allow the freezer to operate for approximately 2 hours before placing frozen food inside.

Freezer Features

Temperature Control

- Located at the lower right hand side of the cabinet.
- At setting No. 4, the temperature will be at or near 0°F (-17.8°C) under normal operating conditions.
- Turning the temperature control all the way to the left or past "0" until it clicks will switch off power to the compressor.
- To adjust the thermostat control: turn control to higher number for colder temperatures, lower number for less cold temperatures. It is recommended that you adjust by one numerical increment at a time, allowing several hours for temperatures to stabilize between increments.
- Some of the models are equipped with preset thermostats which do not have a knob.
- Some models may have the temperature control mounted on cabinet rear.

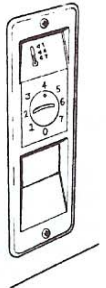

Cool Down Period

- To ensure proper food storage, allow 4 hours for freezer to cool down completely. The freezer will run continuously for the first several hours. Already frozen foods may be placed in after the first few hours of operation, however you must wait 4 hours before placing in any unfrozen food.

IMPORTANT: Freeze approximately 22 pounds (10 kg) of fresh room temperature food at one time. There is no restriction for adding already frozen food. Distribute packages to be frozen evenly throughout the freezer. When freezing food, it is not necessary to set control knob to colder setting.

Sliding Basket (on some models)

- Number of baskets can vary with different models.
- Use your sliding basket(s) to keep frequently used food within easy reach.

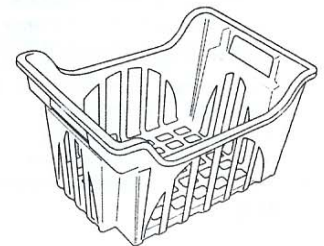

Freezer Features (continued)

WARNING: FAILURE TO DISCONNECT FREEZER FROM POWER SUPPLY WHEN CHANGING BULB COULD RESULT IN PERSONAL INJURY

Interior Light (on some models)

- Turns on whenever you open the lid to your freezer.
- When changing the interior light, disconnect freezer from power supply, replace old bulb with new appliance bulb with similar wattage and re-connect freezer to power supply.

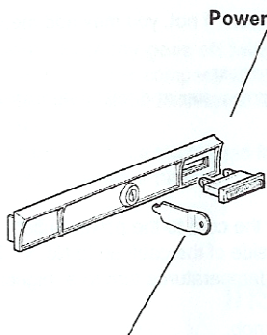

Power Light (on some models)

- The power light normally will be "on".
- Its purpose is to warn you when there is a power absence. If for any reason the power to the freezer is interrupted (blown fuse, loose plug, etc.) the indicator light will be "off".
- **WARNING:** The presence of the light does not indicate proper food temperatures, or proper operation of the refrigeration system.
- Flickering light indicates faulty or burned out light.

WARNING: FAILURE TO DISCONNECT FREEZER FROM POWER SUPPLY WHEN CHANGING BULB COULD RESULT IN PERSONAL INJURY

Built-in Lock (on some models)

- A built-in lock allows you to keep your food supply secure if necessary.
- An excellent tool to help reduce the hazard of child entrapment.
- This type of lock is spring loaded, preventing the key from being left in the lock. To lock or unlock the freezer, you must hold the key in the lock while turning.

Temperature Monitor Alarm (on some models)

Some models feature a temperature monitor that provides an audible alarm. The temperature monitor alarm is located above the temperature control. The alarm sounds if the temperature in the freezer rises 10°F or more above normal for selected setting. Alarm may sound if the temperature control dial is turned to a much lower/colder setting or if a large amount of unfrozen food is added at one time. Alarm is controlled by a three position switch.

- **0** or **OFF** prevents alarm from sounding when freezer is warm, such as during initial start-up or defrosting.
- **✓** or **TEST** sounds alarm regardless of temperature. Alarm system should be tested at least once a month.
- **1** or **ON** is proper setting for normal freezer use. Return switch to **1** after defrosting.

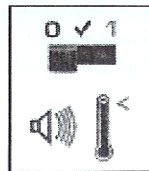

Cleaning Your Freezer

Cleaning the Inside

We recommend the following cleaning method: sprinkle baking soda on the sides and bottom of the freezer, this will help in cleaning and odor removal. In order to retain the finish of the freezer cabinet, inside and outside, wash painted and plastic parts only with warm water and mild soap, then rinse and dry. Do not use, under any circumstances, a gritty soap or a scouring pad as they will scratch the finish.

During the defrosting operation, some water may have dripped from the back flange of the lid cover. This is quite normal. Ice has built-up on the lid insulation during normal operation and this ice will melt during defrosting. You will probably have to fold over and dry the gasket on the hinge side of the lid to complete the cleaning process.

Cleaning the Outside

Wash the cabinet with warm water and mild liquid detergent. Rinse well and wipe dry with a clean soft cloth.

Save These Instructions

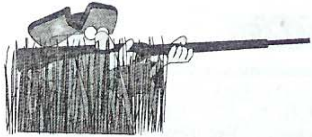

Troubleshooting

FREEZER DOES NOT WORK

- Freezer may not be plugged in. Make sure plug is secure.
- Perhaps outlet is not working properly or fuse is burned out. Try plugging in a small appliance to check outlet.

LID WON'T CLOSE ALL THE WAY

- Package may be holding lid open.
- Baskets may be overlapping at corners.

EXCESSIVE FROST BUILD UP

- Package may be holding lid open.
- Opening lid excessively or left open for too long.

FOODS DEFROSTING

- Freezer may not be plugged in.
- Outlet is not working properly or fuse is burned out.
- Package is holding lid open or lid is being opened excessively or for too long.

WET OUTSIDE CABINET

- Extended hot, humid weather.

FOODS ARE DRYING OUT

- Not properly wrapped or sealed.

FREEZER TOO COLD

- Temperature control set too high. Adjust and wait several hours for temperature to stabilize.

FREEZER TOO WARM

- Temperature control set too low. Adjust and wait several hours for temperature to stabilize.
- Lid is being open too often or too long.
- Large amount of warm or hot food has been stored requiring time for cool down again
- Freezer lid is open slightly.
- Freezer had recently been disconnected and needs time to cool down again.

FREEZER STARTS OFTEN

- Package holding lid open, lid open too often or too long.

FREEZER OPERATES TOO LONG

- Temperature control set on too high a setting.
- Freezer may be maintaining a uniform temperature.
- Room or outside temperature is hot. A freezer would normally work harder under these conditions.
- Freezer had recently been disconnected and needs time to cool down again.
- Large amount of warm or hot food has been stored requiring time for cool down again
- Lid is being open too often or too long.
- Freezer lid is open slightly.
- Gasket is dirty, worn, cracked, or poorly fitted. Clean or change gasket. Leaks in the door seal will cause freezer to run longer in order to maintain desired temperature.

SLOW TO START AFTER BEING OFF

- Built in overload protection at work.

ODOUR IN FREEZER

- Interior needs to be cleaned.

EXTERNAL FREEZER SURFACE TOO WARM

- The exterior freezer walls can be as much as 30°F (16.6°C) warmer than room temperature. This is normal.

TOO NOISY

- Floor weakness, freezer may vibrate if compressor is on
- Cabinet is not positioned solidly. Shim to even freezer.
- When the surrounding noise level is low, you may hear the compressor running. This is normal as freezers require high efficiency compressors.

LOUDER SOUND LEVELS WHEN COMPRESSOR COMES ON

- During the start of the 'ON' cycle, the freezer operates at higher pressures. This is normal. Sound will level off or disappear as the freezer continues to run.

POPPING OR CRACKING SOUND WHEN THE FREEZER COMES ON

- This is normal. The metal parts within the freezer expand and contract. The sound should level off or disappear as the freezer continues to run.

BUBBLING OR GURGLING SOUND

- When refrigerant is circulating throughout the system this type of sound may be heard. This is normal.

VIBRATING OR RATTLING NOISE

- Freezer is not level.
- Floor is uneven or weak.

Energy Saving Tips

- Be careful not to leave the lid open. Always make sure that the lid is closed properly.
- Try not to open the lid more than is necessary especially in hot, humid weather.
- Arrange frozen food systematically so you can quickly find what you need.
- The location of your freezer is very important. Don't situate it in a warm, unventilated room, next to your range or heating vent or where it is in direct contact with the sun.
- If you turn the temperature control to the coldest setting for quick freezing, don't forget to turn it back to the normal setting.
- Defrost the freezer whenever the frost become 1/4" thick.
- A full freezer stays cold longer than a partly filled one. A freezer full of meat stays cold longer than a freezer full of baked goods.
- Let hot foods cool to room temperature before placing in the freezer. Overloading the freezer forces the compressor to run longer. Foods that freeze too slowly may lose quality or spoil.
- Be sure to wrap foods properly and wipe containers dry before placing them in the freezer. This cuts down on frost build-up inside the freezer.
- Freezer shelves and baskets should not be lined with aluminum foil, wax paper, or paper toweling. Liners interfere with cold air circulation, making the freezer less efficient.

Vacation and Moving Tips

Short Vacations (less than 3 weeks): Leave the freezer operating.

Long Vacations: If the freezer will not be used for several months, remove all food and unplug the power cord. Clean and dry the interior thoroughly. To prevent odor and mold growth, leave the freezer door open slightly, blocking it open if necessary.

Moving: Disconnect the power cord plug from the wall outlet. Remove food, defrost and clean freezer. Secure all loose items such as base panel, baskets and shelves by taping them securely in place to prevent damage. In the moving vehicle, secure the freezer to prevent movement and protect the outside of the freezer with a blanket or similar item.