

WIRELESS CONNECTIVITY & SENSORS

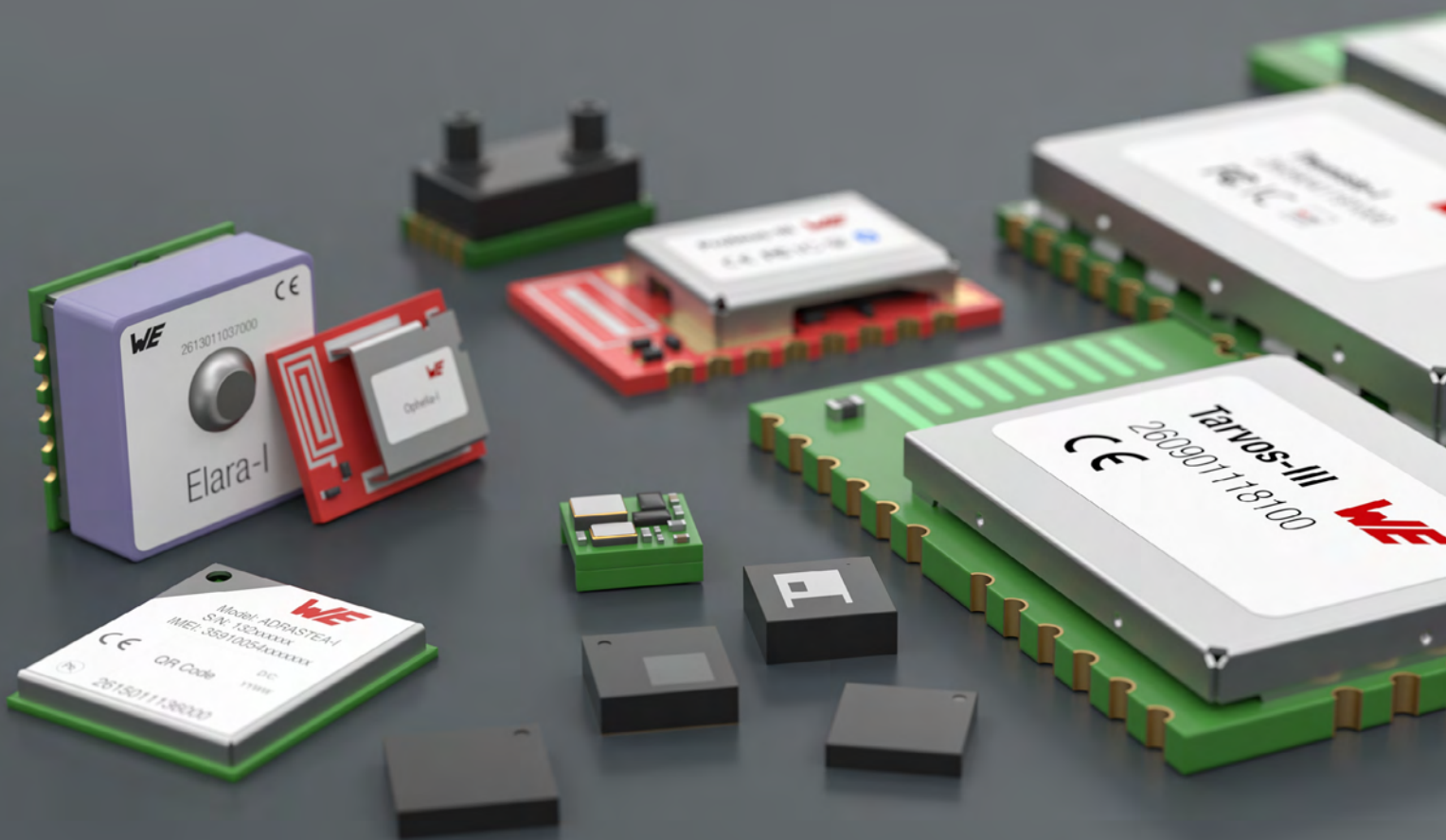

WÜRTH ELEKTRONIK MORE THAN YOU EXPECT

THE WÜRTH ELEKTRONIK eiSos GROUP



GLOBALLY AVAILABLE. LOCALLY PRESENT.



THE WIRELESS CONNECTIVITY & SENSORS STORY

WHERE WE CAME FROM

2016 was a milestone for Würth Elektronik. AMBER wireless GmbH was acquired and integrated into the Würth Elektronik eiSos Group in 2018. In parallel Würth Elektronik set up a team around sensor technologies.

Today, with almost 25 years of experience in the development of radio products and with key people in the field of sensor technologies, Würth Elektronik established a core pillar to its future business, the division „Wireless Connectivity & Sensors“.

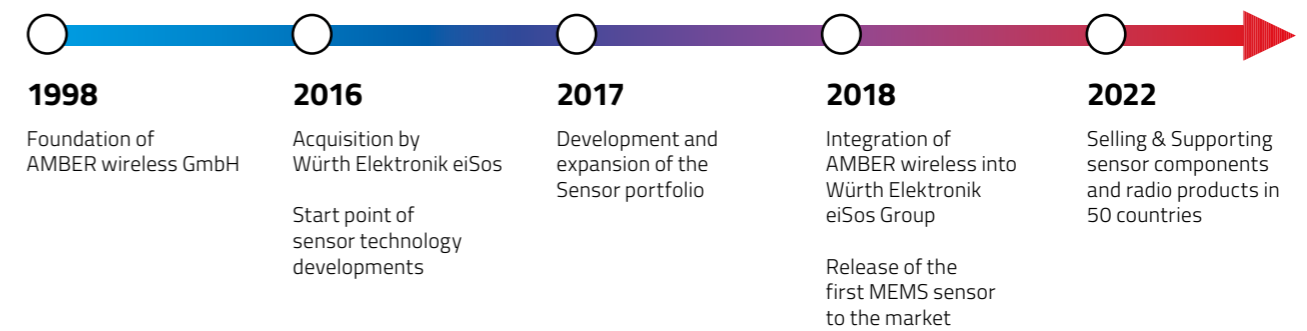

WHO WE ARE

Wireless Connectivity & Sensors - these are not just wireless modules and sensors. Behind them is a team identifying themselves passionately with the products. But it's not all about the products – it's about people, these values make us strong. Following the old AMBER claim "One for all, all for one", we are living our dedication towards the customers.

EASY AND FAST ACCESS TO ALL INFORMATION

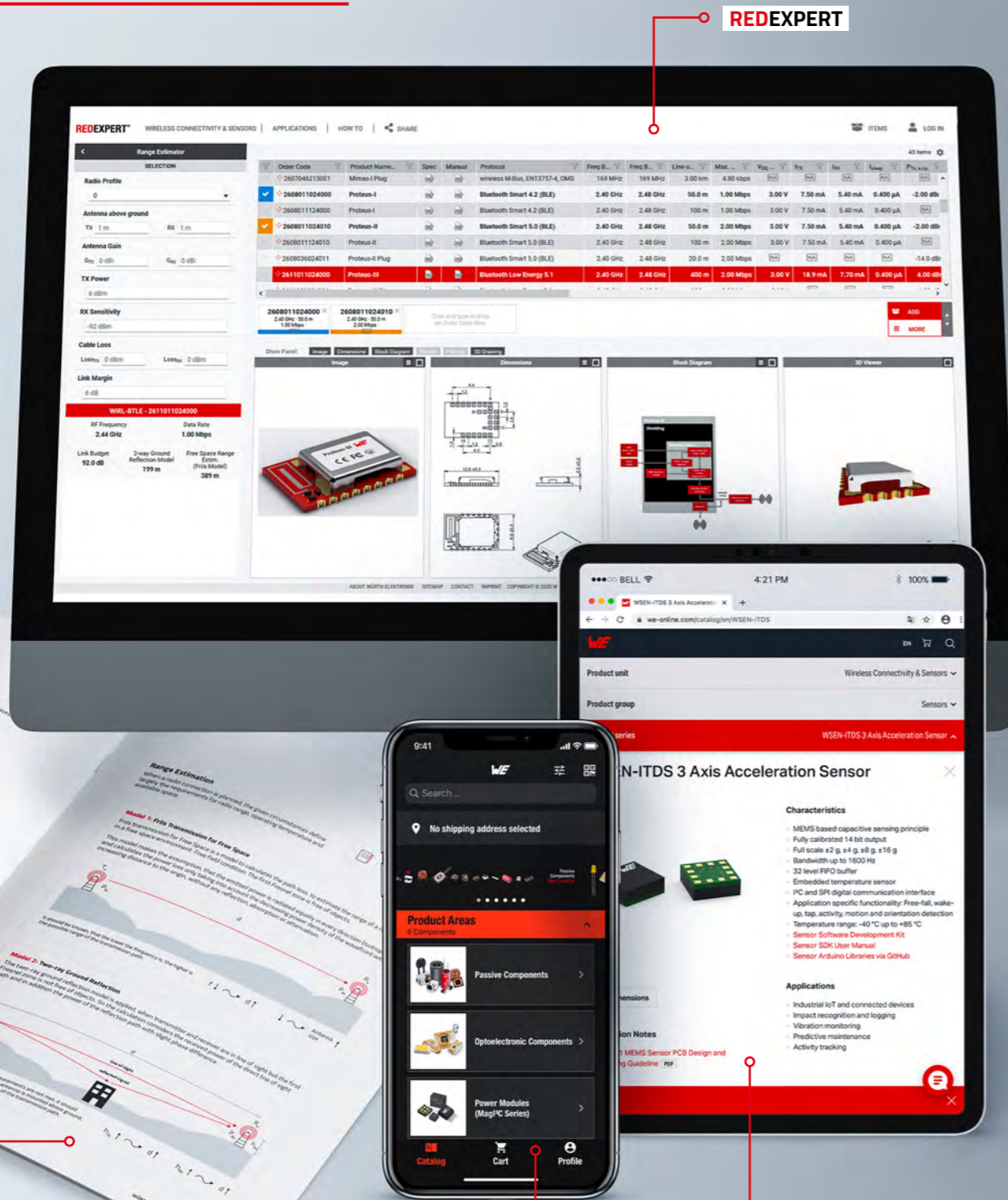

PRODUCT GUIDE

iOS APP

WEBSITE



Product Guide Download:
www.we-online.com/wcs-product-guide



Download the Catalogue App of Würth Elektronik to
access all product information on your mobile device:
www.we-online.com/app



Redexpert:
www.we-online.com/redexpert



CONTENT

WIRELESS CONNECTIVITY

	CE FC IC	INTRODUCTION & FUNDAMENTALS	14
		Connect Machine Globally	CELLULAR 34
		Connect Machine to Mobile Device	BLUETOOTH® LOW ENERGY 46
		Connect Machine to Internet	WI-FI 60
		Connect Machine to Machine	PROPRIETARY 68
		Connect M2M & Mobile Device	COMBINED 84
		Connect all together	MESH 92
		Connect Smart Meter	WIRELESS M-BUS 102
		Open Module/No Firmware	BUILD YOUR OWN FIRMWARE 110
		Positioning & Time Reference	GNSS 116

SENSORS

	INTRODUCTION & FUNDAMENTALS	122
	TEMPERATURE	130
	HUMIDITY & TEMPERATURE	132
	ACCELERATION	134
	ABSOLUTE PRESSURE	136
	DIFFERENTIAL PRESSURE	138

ADDITIONAL INFORMATION





















SOFTWARE TOOLS 146











EVALUATION KITS 150

ACCESSORIES 158

Information in this publication is subject to change. The process of continually improving our product range leads to changes in content. For new designs please refer to the latest data sheets on www.we-online.com or contact our technical field staff.

ONE CLICK SELECTION

WIRELESS CONNECTIVITY			
GNSS	BLUETOOTH	PROPRIETARY	
 Elara-I GPS, GLONASS Integrated Antenna 10 x 10 x 5.9 mm	 Proteus-I / -II Bluetooth® LE 4.2 Bluetooth® LE 5.0 Nordic nRF52832 3 dBm output power 11 x 8 x 2 mm	 Thadeus 433 MHz RF Pad 15 dBm output power 27 x 17 x 3.8 mm	
 Elara-II GPS, GLONASS RF Pad 4.1 x 4.1 x 2.2 mm	 Proteus-III Bluetooth® LE 5.1 Nordic nRF52840 6 dBm output power 12 x 8 x 2 mm	 Tarnos-III 868 MHz RF Pad / PCB Antenna 14 dBm output power 27 x 17 x 3.8 mm	
 Erinome-I GPS, GLONASS, GALILEO, BEIDOU Integrated Antenna 18 x 18 x 6.4 mm	 Proteus-e Bluetooth® LE 5.1 Nordic nRF52805 4 dBm output power 9 x 7 x 2 mm	 Thebe-II 868 MHz RF Pad 27 dBm output power 27 x 17 x 3.8 mm	
 Erinome-II GPS, GLONASS, GALILEO, BEIDOU RF Pad 7 x 7 x 1.6 mm	COMBINED		
WM-BUS			
 Mimas-I 169 MHz OMS Operating mode: N (a-f) output power 14 dBm 27 x 17 x 3.8 mm	 Setebos-I Bluetooth® LE 5.1 & WE-ProWare 2.4 GHz 8 dBm output power 12 x 8 x 2 mm	 Themisto-I 915 MHz RF Pad 25 dBm output power 27 x 17 x 3.8 mm	
WIREPAS			
 Metis-II 868 MHz OMS operating modes S, T, C output power 14 dBm 27 x 17 x 3.8 mm	 Thetis-I Wirepas routing mesh protocol, 2.4 GHz +6 dBm output power 8 x 12 x 2 mm	 Triton 2.4 GHz RF Pad / Chipantenna 10 dBm output power 27.5 x 16 x 3.2 mm	
 Metis-Analyzer 868 MHz OMS parser operating modes S, T, C deep packet analysis Decryption (AES128)	 Thyone-I 2.4 GHz Smart antenna selection 8 dBm output power 12 x 8 x 2 mm		
 Metis-Simulator 868 MHz OMS operating modes S, T, C Simulates Meter Data	WI-FI		
	 Calypso IEEE 802.11 b/g/n 2.4 GHz +18 dBm output power 19 x 27.5 x 4 mm	CELLULAR	
		 Adrastea-I LTE-NB.IoT / Cat.M1 incl. GNSS 14 x 13 x 2 mm	

SENSORS		
HUMIDITY	ABSOLUTE PRESSURE	DIFFERENTIAL PRESSURE
 WSEN-HIDS 16 bit humidity and temperature output I ² C and SPI interface 2 x 2 x 0.9 mm	 WSEN-PADS 26 – 126 kPa 260 – 1260 mbar 24 bit output resolution 2 x 2 x 0.8 mm	 WSEN-PDUS ±0.1 kPa / ±1 mbar 15 bit digital output Analog & I ² C interface 13.3 x 8 x 7.55 mm
TEMPERATURE		 WSEN-PDUS ±1 kPa / ±10 mbar 15 bit digital output Analog & I ² C interface 13.3 x 8 x 7.55 mm
 WSEN-TIDS digital temp. sensor up to ±0.25 °C typ. 16 bit output resolution 2 x 2 x 0.55 mm	ACCELERATION	
	 WSEN-ITDS 3 axis acceleration 14 bit output resolution ±2g, ±4g, ±8g, ±16g 2 x 2 x 0.7 mm	 WSEN-PDUS ±10 kPa / ±100 mbar 15 bit digital output Analog & I ² C interface 13.3 x 8 x 7.55 mm
		 WSEN-PDUS -100-1000kPa/-1-10bar 15 bit digital output Analog & I ² C interface 13.3 x 8 x 7.55 mm
		 WSEN-PDUS 0-100 kPa / 0- 1 bar 15 bit digital output Analog & I ² C interface 13.3 x 8 x 7.55 mm
		 WSEN-PDUS 0-1500 kPa / 0- 15 bar 15 bit digital output Analog & I ² C interface 13.3 x 8 x 7.55 mm



Product Guide Download:
www.we-online.com/wcs-product-guide

**YOU NEED SUPPORT?
 CONTACT US!**
www.we-online.com/wcs-support

MORE THAN YOU EXPECT



SAY YES TO OUR FAST AND
COST-FREE DESIGN-IN SUPPORT



WE TAILOR THE QUANTITIES
TO YOUR NEEDS



ALL CATALOGUE PRODUCTS
AVAILABLE EX STOCK



SEMINARS & WEBINARS



ONLINE DESIGN PLATFORM FOR
COMPONENT SELECTION & SIMULATION



COMPONENT LIBRARIES –
MAKING HARDWARE INTEGRATION EASY



APPLICATION NOTES



TOTAL QUALITY MANAGEMENT

MORE ADDED VALUES

Full Service Products
Hardware + Firmware

page: 20



APIs and Software
Development Kits

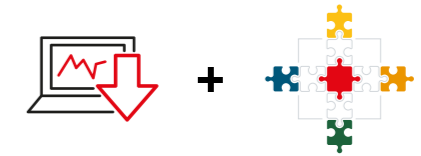

Software Individualization and
Custom Sensor Characterization

page: 30

page: 140

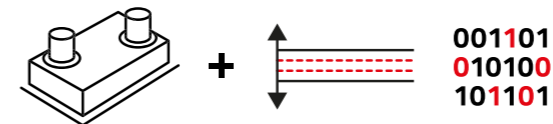

Configurable User Settings
with our Firmware
WE-ProWare

page: 28

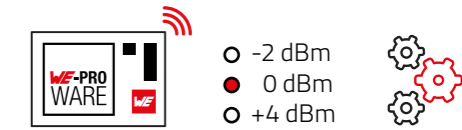

Free of Charge PC-Software
and Mobile Apps

page: 146



Technical Support –
Talk from Engineer to Engineer

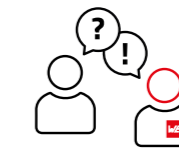

Evaluations Kits
and USB Radio Sticks

page: 150

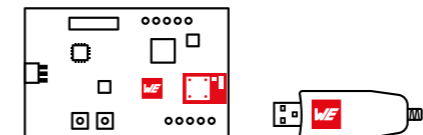

Certification and Conformity –
CE, FCC, IC & Teleg

page: 18



Proven High Frequency
PCB-Design & Proven Antenna
Characteristics

page: 23

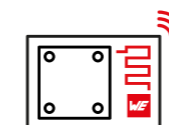

Long Term Availability



KNOWLEDGE

With the following material we would like to provide you with knowledge that will support you in your daily work.

Besides this Product Guide we offer videos, tutorials, seminars, technical reports and other helpful materials that you can use. We are happy to assist you as a knowledge specialist.



WEBINARS

Check out our videos and webinars produced by our engineers and technology specialists. They will present you tutorials and applications, explain the use of design rules and design tips and much more. Take the opportunity to gain information within a short presentation: independent, flexible and interactive!

WIRELESS CONNECTIVITY & SENSORS

All videos on demand



SEMINARS

Missed a webinar? Not the right topic? Request your personal digital seminar! Put together an individual seminar program for you and your colleagues. It's that easy: Use the request form on our homepage to select exactly the topics that interest you and arrange your preferred date with our colleagues. In digital short sessions of approx. 30 - 45 min. duration per topic, our electronics experts provide targeted insights for developers and answer your questions - live and completely free of charge.



we-online.com/Seminars

APPNOTES & MANUALS

We are happy to support you with the design in of our radio modules and sensors and provide you with detailed information in our user-friendly application notes and manuals. We go into detail about the various features, provide helpful information about processing on the board and give you additional information, for example, on the ideal use of an antenna. This allows you to quickly get an idea of the performance range of our wireless modules and sensors. Simply download the appropriate application note or manual from our online shop.



we-online.com/AppNotes

WÜRTH ELEKTRONIK MORE THAN YOU EXPECT

REDEXPERT



REDEXPERT The online platform of Würth Elektronik to select electronic and electromechanical components.

#REDEXPERT

- Online platform based on measured values
- The world's most accurate AC-loss model
- Filter settings for over 20 electrical and mechanical parameters
- Inductor simulation and selection for DC/DC converters
- Ability to compare inductance/current and temperature rise/DC current using interactive measurement curves
- Available in seven languages
- No login required
- Order free samples directly
- Direct access to product datasheets

www.we-online.com/redexpert

DISCOVER THE
WORLD OF
WIRELESS
CONNECTIVITY



INTRODUCTION & FUNDAMENTALS	14	COMBINED	84
CELLULAR	34	MESH	92
BLUETOOTH® LOW ENERGY	46	WIRELESS M-BUS	102
WI-FI	60	BUILD YOUR OWN FIRMWARE	110
PROPRIETARY	68	GNSS	116

FUNDAMENTALS

RADIO COMMUNICATION

The History of Radio Technology

Radio technology is a wireless method of transmitting signals by means of modulated electromagnetic waves. In 1884 James Clerk Maxwell predicted the existence of radio waves, which was experimentally confirmed by Heinrich Hertz on November 11th, 1886.

There are five main key facts, which have to be considered:

1. Transmission of the Signal
2. Link Budget
3. Duty Cycle
4. Access
5. Integration of Radio Technology

1. Transmission of the Signal

For the Transmission the signal will be modulated on a carrier signal, mostly sinus with constant amplitude. Thereby the amplitude or frequency will be adopted in the rhythm of the transmitted signal. The modulated wave is radiated by an antenna and received on the otherside with an antenna too. Due to demodulation at the receiver the transmitted signal can be used.

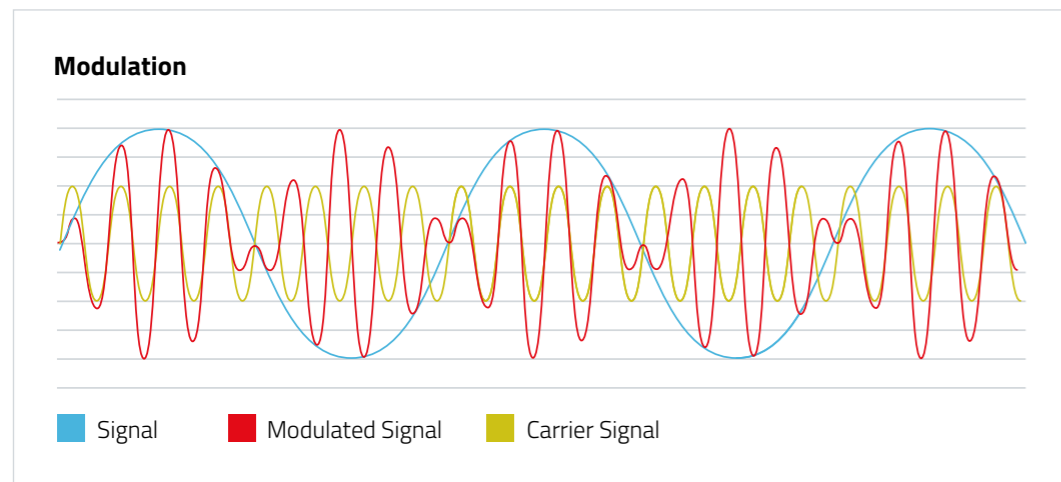
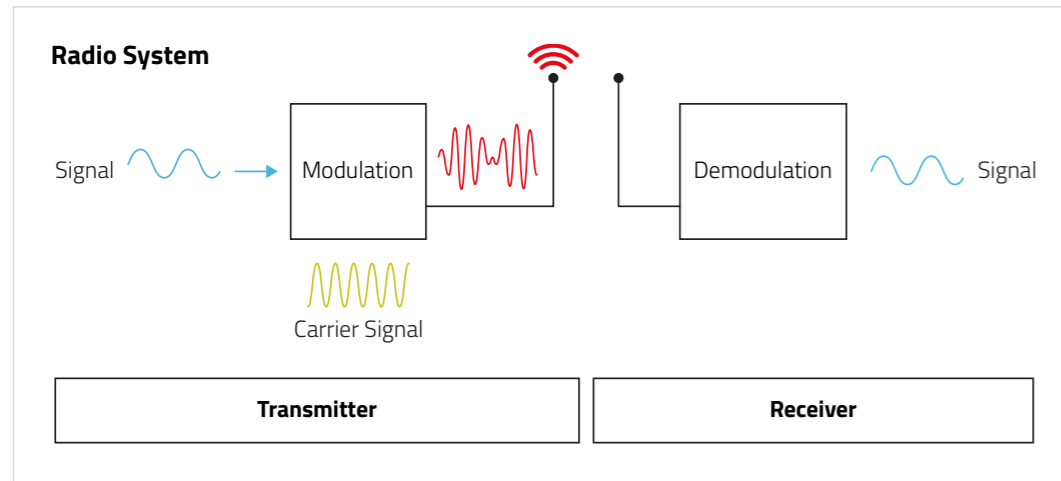

Range Estimation

When a radio connection is planned, the given circumstances define largely the requirements for radio range, operating temperature and available space.



ANR010 Range Estimation

we-online.com/ANR010

Model 1: Friis Transmission for Free Space

Friis transmission for Free Space is a model to calculate the path loss, to estimate the range of a radio link in a free space environment. Free field condition: The first Fresnel zone is free of objects.

This model makes the assumption, that the emitted power is radiated equally in every direction (isotropic) and calculates the power loss only taking into account the decreasing power density of the wavefront with increasing distance to the origin, without any reflection, absorption or attenuation.



It should be known, that the lower the frequency is, the higher is the possible range of the transmission path.



Model 2: Two-ray Ground Reflection

The two-ray ground reflection model is applied, when transmitter and receiver are in line of sight but the first Fresnel zone is not free of objects. So the calculation considers the received power of the direct line of sight path and in addition the power of the reflection path with slight phase difference.

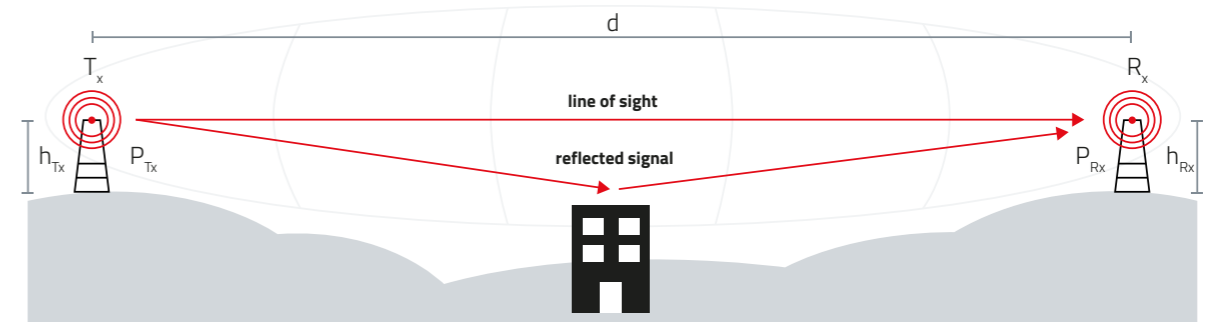

As long as the free space requirements are not met, it should be known, that the higher the antenna is mounted above ground, the higher is the possible range of the transmission path.



FUNDAMENTALS

RADIO COMMUNICATION

Conclusion

In a lot of cases there is the need of long distances with regard to the antenna height, so usually the two ray ground model is a good fitting estimation. Only for some special cases with the free space condition fulfilled the Friis model is useful. Having a closer look to the models there are several interesting points to mention.

The Dependency of the Frequency

Often it is mentioned in general, that the lower the frequency is, the greater the range is. We have learned, that this is only the case when free field conditions are met. But there are other effects of the frequency, as the fact, that for higher frequencies smaller objects will cause reflections, or that for low frequencies it might be hard to find an antenna with acceptable size and efficiency.

The Influence of the Antenna Height on the Range

The higher the antennas can be placed, the longer is the range that can be reached. Placing an antenna directly above ground reduces the range so radical, a layman could hardly imagine.

2. Link Budget (power of the carrier)

A link budget is an accounting of all of the power gains and losses that a communication signal experiences in a telecommunication system; from a transmitter, through a medium (free space, cable, waveguide, fiber, etc.) to the receiver. It is an equation giving the received power from the transmitter power, after the attenuation of the transmitted signal due to propagation, as well as the antenna gains and feedline and other losses, and amplifications of the signal in the receiver or any repeaters it passes through.

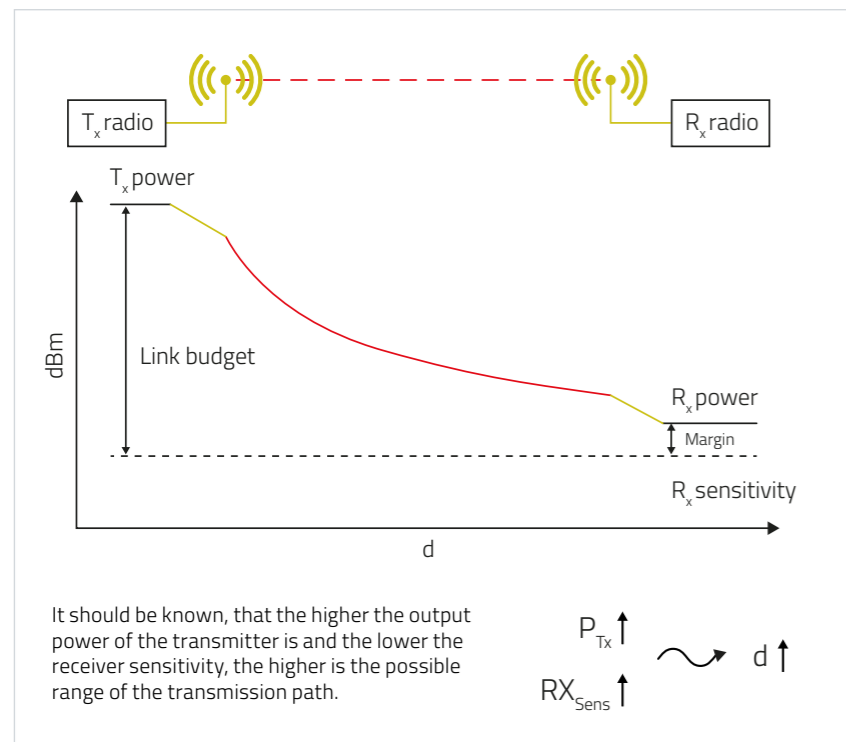

Power [dBm]	Power [watt]
- 120 dBm	1 fW
- 110 dBm	0.01 pW
- 100 dBm	0.1 pW
- 90 dBm	1 pW
- 80 dBm	10 pW
- 70 dBm	100 pW
- 60 dBm	1 nW
- 50 dBm	10 nW
- 40 dBm	100 nW
- 30 dBm	1 μW
- 20 dBm	10 μW
- 10 dBm	100 μW
- 1 dBm	794 μW
0 dBm	1 mW
1 dBm	1.26 mW
10 dBm	10 mW
20 dBm	100 mW
30 dBm	1 W
40 dBm	10 W

3. Duty Cycle

A duty cycle or power cycle is the fraction of one period in which a signal or system is active. Duty cycle is commonly expressed as a percentage or a ratio. A period is the time it takes for a signal to complete an on-and-off cycle. E.g. using a duty cycle of 10 %, means that the used transmitter is allowed to send 6 minutes in between one hour.

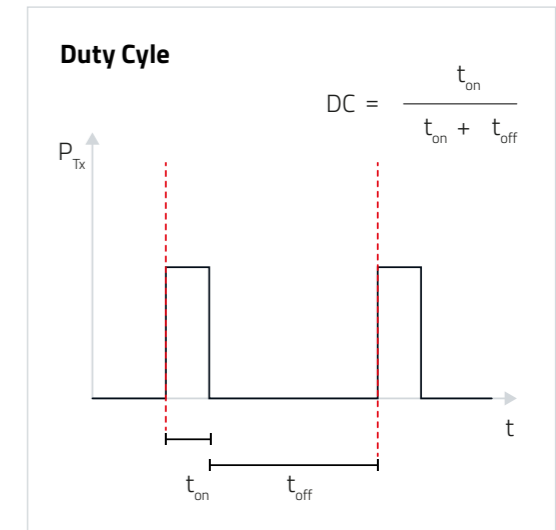

4. Polite Spectrum Access – listen before talk

When an application uses polite spectrum access, the duty cycle restrictions are loosened. Polite spectrum access encompasses two aspects: Listen Before Talk (LBT) and Adaptive Frequency Agility (AFA). LBT defines that the device must listen if the medium is already in use by a Clear Channel Assessment (CCA) check. When the medium is in use, the device must wait a random backoff interval or change the frequency before checking again. The latter is called AFA.

5. Integration of Radio Technology

One of the last steps before a product with integrated wireless technology can be launched on the market is the certification. Manufacturers of products with integrated RF-technology may only market these with the necessary certification. The following graphics display the three options which are available for integrating wireless technology.

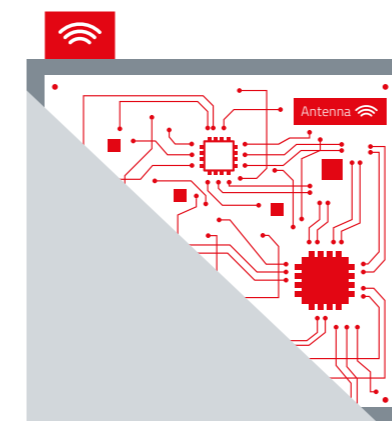

1 Device without certified radio chip and antenna

- ⊕ Flexible
- ⊖ High effort
- ⊖ High costs

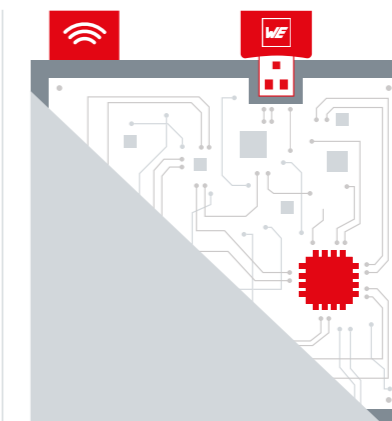

2 Device with external radio dongle

- ⊕ Plugable
- ⊕ Easy integration
- ⊖ Not that flexible

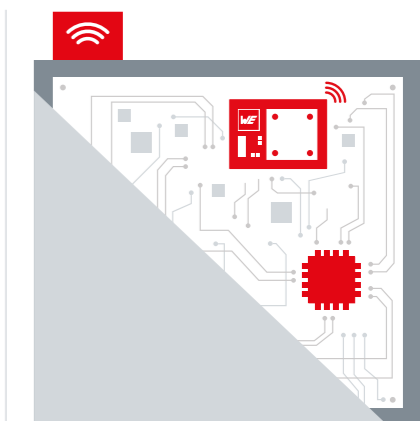

3 Device with certified radio module and antenna

- ⊕ Low design effort
- ⊕ Fully integrated
- ⊕ Low Certification effort
- ⊖ Not that flexible

CERTIFICATION & CONFORMITY

Which Certification Rules apply where?

A product that is to be launched globally must meet the certification or conformity criteria of each country it is to be marketed in. It is a kind of a prove to the authorities, that the explained facts (1), (2), (3) and (4) are compliant to regulations, laws, norms, standards and so on. There is no worldwide certification applicable to all countries. The following presents the various certification systems.

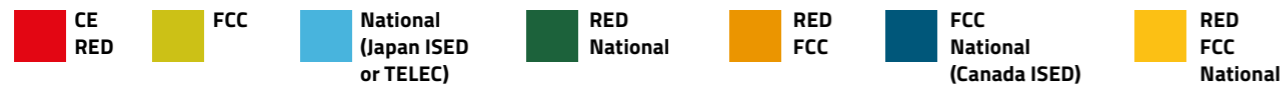
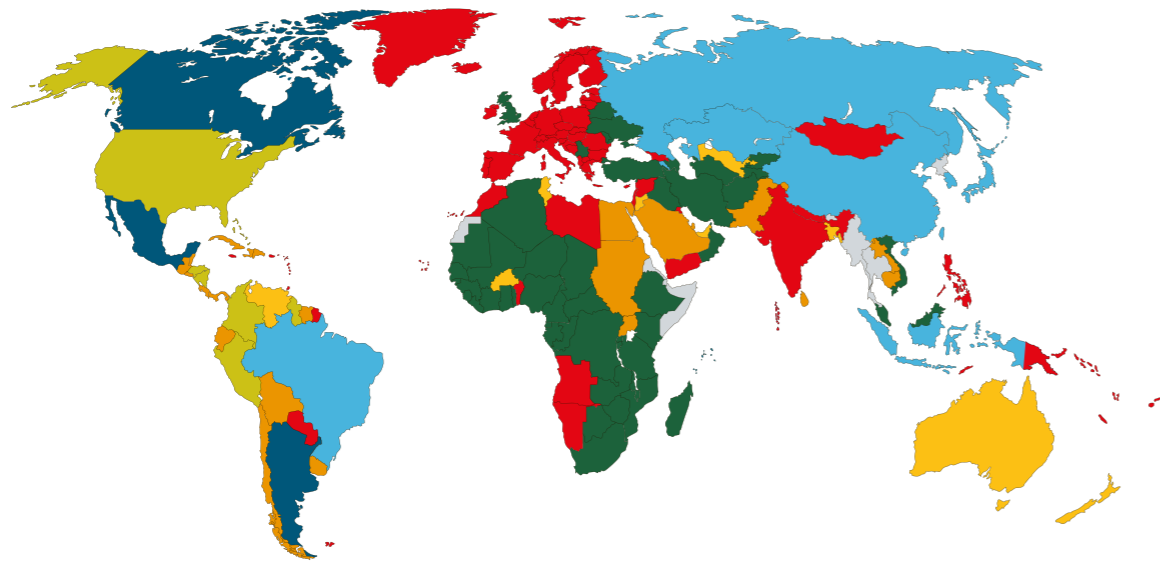

Different Certification Systems



For products distributed in the European market the CE mark is required. The manufacturer applies the CE mark after fulfilling the Radio Equipment Directive (RED). The tests may be conducted either by the manufacturer himself or by an accredited laboratory. As self declaration the manufacturer is responsible for the products conformity to legal restrictions and regulations.



For all other markets national regulations apply. For example, a product introduction in Canada or Japan require ISED or TELEC certification. Most countries are close to CE or FCC. Deadlines, requirements and measurements can differ.



In North America, however, products with wireless technology require FCC certification. A certification through an verified authority with measurements is mandatory.



These, similar to other national regulations, are based on the existing certification bodies, so that only a small amount of additional testing is required. E.g. Canada or United Kingdom.

Certificate Examples



The **manufacturer** declares, that...





The **regulation body** certifies that...

Benefits of Certification and Conformity

- Be smart and ensure that your product will pass the certification process!
- Obtain assurance – Pre-certification is half the battle won and reduces the final test effort.
- Save time and money – the likelihood that the end product will pass is much greater with pre-certification.

All Würth Elektronik radio modules are either certified and / or declared for conformity. This simplifies the approval process of such a radio module within the end-application significantly.

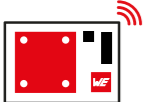
WHY USING A RADIO MODULE?

			page: 144
<p>HW Hardware</p> <ul style="list-style-type: none"> Powerful RF-Chips Design of Ready-to-use Modules Antenna-Design Edge Castellation allows hand soldering in prototyping or small series production 	<p>FW Firmware</p> <ul style="list-style-type: none"> WE-ProWare Radio Stack Requirement for approval (CE, FCC, IC, TELEC) 20 years of experience Developed for industrial and medical requirements Easy to handle and to integrate 	<p>SW Software</p> <ul style="list-style-type: none"> Plug & Play PC-Software for easy evaluation, testing and updating Mobile Apps for easy evaluation & testing Design libraries available for fast PCB design for Altium and Eagle Software Development Kit (C-Files) for comfortable coding of the HOST-controller system 	

ADDED VALUES

In comparison there is big potential for saving time and money by using an RF-module instead of the single RF-IC. With a pure HW-RF-module you can save HW-development resources, since the required circuitry is completely included. An integrated antenna enables an easy integration, even with a minimum of RF knowledge. The software integration, testing and certification effort will be minimized if the Firmware is already available, because the FW is linked to module certification.

- ✓ FASTEN TIME TO MARKET
- ✓ LOWER DEVELOPMENT COST
- ✓ INCREASE MARKET SUCCESS

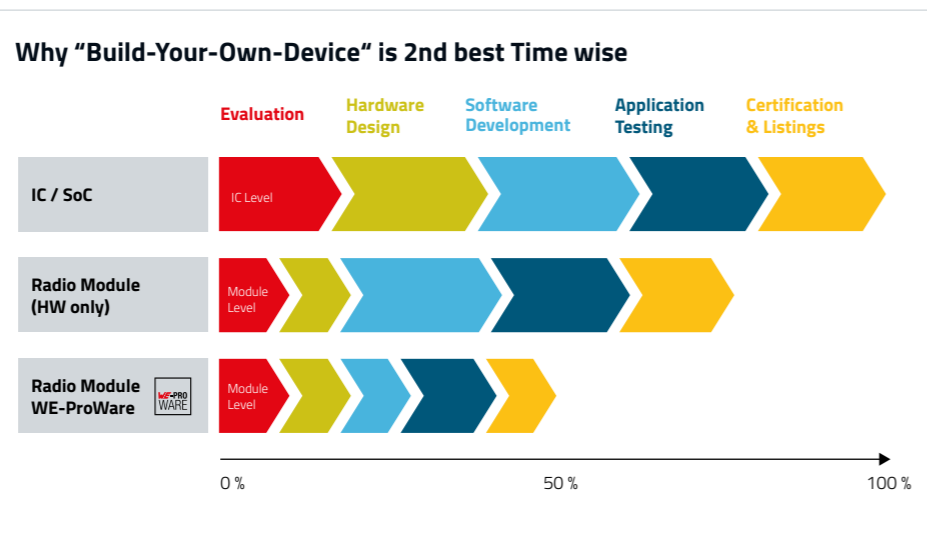
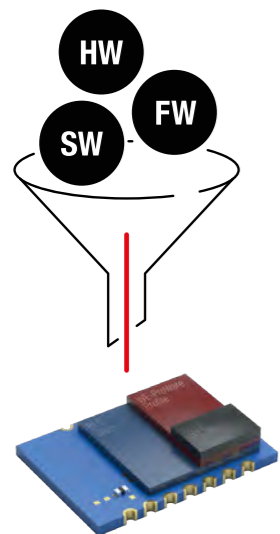

WHY "BUILD-YOUR-OWN-DEVICE" IS 2ND BEST CHOICE

The situation for every system designer, purchaser or similar related functions is always the same. It needs to be compared between an "Off-the-shelf" solution or a "Build-Your-Own-Device" solution. For this process we want to offer a list of key aspects, which Würth Elektronik sees as important to be able to take this decision. We differentiate between three main categories in costs.

	What is necessary to consider?	
	Würth Elektronik "Off-the-Shelf" radio module	Customer "Build-Your-Own-Device"
1. FIXED COSTS		
<p>Module Buy-Price The buying price of the radio module should compare apples by apples. A Würth Elektronik Module always comes with in a package of Hardware (radio module), Firmware (µC & RF stack) and the needed Software for evaluation. One price includes all features. "Building-Your-Own-Device" needs to consider ADDITIONALLY the following investments.</p>	€€	€
<p>Hardware Development The hardware costs are more than just the Bill of Materials for like Microcontroller, IC, Oscillator, Antenna, PCB, LNA, and more. It needs to be taken into account the development itself, the necessary rework during the prototype-to-series phases, the antenna design and possible revisions while the device is already in the market. Using an "Off-the-shelf" solution makes all this mainly unnecessary, as Würth Elektronik is taking care of that for you.</p>		€
<p>Firmware Development The Firmware running on a radio modules is an accumulation of the one-time software development costs, the recurring costs for software maintenance and required updates and don't forget the necessary documentation. This can simply sum up in a 6-digit Euro investment and following needs to be broken down to each single radio module. Würth Elektronik eiSos modules require a minimum of configuration like communication between module and host microcontroller into the end application from the system designer. A budget of a few days is realistic.</p>		€€
<p>Required Measurement Equipment The final step while taking the radio module into operation is the necessity of measuring all electrical parameters. Therefore it requires to have measurement tools like a Signal Generator, Spectrum & Signal Analyzer and Oscilloscope available, which represent another 6-digit investment, unless those have already been purchased before.</p>		€€
2. VARIABLE & FIXED COSTS		
<p>Certifications, Conformity, Declaration A product that is to be launched globally must meet the certification or conformity criteria of each country it is to be marketed in. It can be compared with the typical iceberg model, where the measurements, the official certificate or the official stamp only represents the tip. For a "Build-Your-Own-Device" solution it requires a comprehensive knowledge of all those regulations in each country and following a huge time investment, also for the documentation. Würth Elektronik radio modules come along with the Declaration of Conformity following the Radio Equipment Directive for Europe and on top with a variety of different certifications complying to regulations in the United States, Canada, Japan and some even with the Chinese law. To be on the safe side with the end device, Würth Elektronik recommends a simple and very low cost delta measurement in the final device, as all the documentation will be provided to the customers test lab. Using a USB radio stick from Würth Elektronik makes it even easier – Plug & Play, ready to operate at lowest possible costs.</p>	€	€€
3. OPPORTUNITY COSTS		
<p>Avoid Delayed Market Entry and loose Money Last but not least, deciding for a "Build Your Own Device" solution will set you back several month in most of the cases. Simply, it is missing sales in the market. Instead, using an "Off-the-shelf" radio module solution from Würth Elektronik and starting to sell the end device earlier will accelerate the market release of the end device. It is like gaining time and early profit.</p>		€

HARDWARE

Speed up your time-to-market

Our modules are fully developed, **tested and validated**. The modules include all essential components. Running WE-ProWare radio stack on our modules ensures a reliable communication through standard protocols and proven RF performance.

Open New Markets

One footprint for different frequencies

Most of our modules offer the **same foot print** and form factor. Make use of this feature to easily exchange modules and adapt your application to specific requirements.

Best-in-class integrated PCB antenna

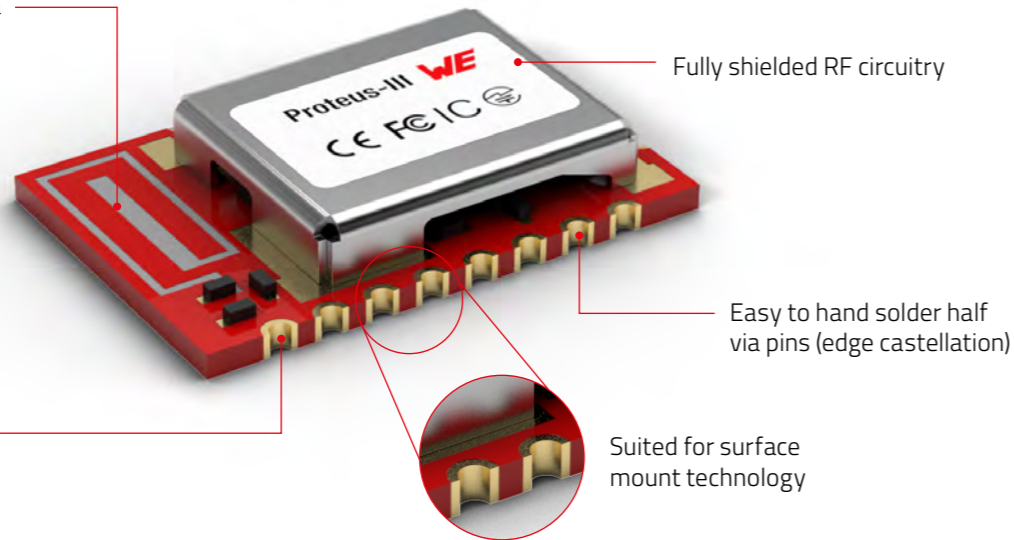

Standard 50 Ohm antenna interface for an external antenna

ADVANTAGES

- ✓ Faster development with a complete RF-module
- ✓ Possibility to work with RF even if there are limited resources in man power or knowledge
- ✓ No Antenna Design necessary. Integrated antenna!
- ✓ Easy soldering, even by hand for smaller quantities in Prototype-phase or for small series
- ✓ Design in guide for all modules
- ✓ Design in support by Hardware-, Software- and Application-engineers

One Hardware Platform

Committing today on a wireless technology for tomorrow seems impossible. Würth Elektronik offers you a high degree of freedom with one radio module footprint for a lot of radio modules to expand your application with different radio protocols at any time without any layout changes. It is one quality proven hardware base, that prevents you from enormous costs of re-design in future already today.

E.g. choose between a Bluetooth®, Wirepas™ or proprietary radio module or the combined variant of proprietary and Bluetooth®.

Design Libraries

- Available for fast PCB-unbundling
- For Altium and Eagle



INTEGRATED ANTENNA MATCHING

Design based on Simulation

The focus of the integrated antenna is for highly miniaturised design. The design ideas are optimized by antenna simulation for best performance. Beside the commonly used parameter of antenna dimensions also the influence of the ground plane of the motherboard is considered in the simulation.

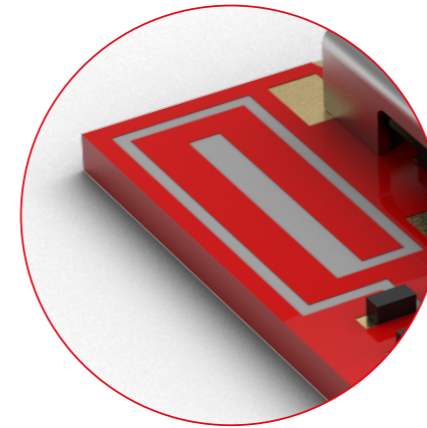

Simulation

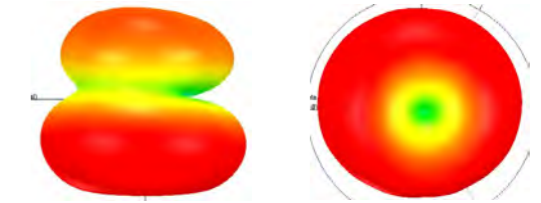

Measurement

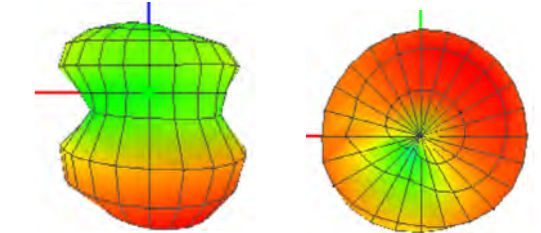

Contact our RF engineers today!

antenna.matching@we-online.com

Verification evaluation board

A second step of optimisation is the verification of the design by measuring it's radiated power and characteristics.

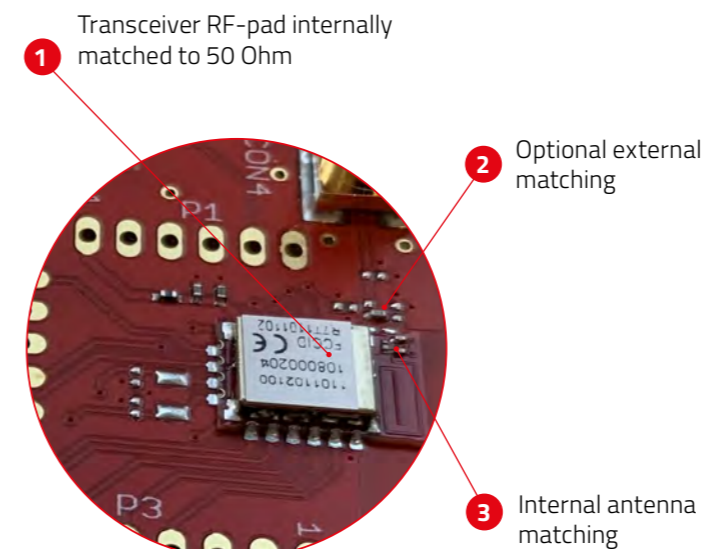

Impedance Matching

With the internal antenna matching the integrated antenna is perfectly matched to the evaluation board.

An external matching is optional possible to either match any antenna to the module as well as re-matching the integrated antenna to different environmental conditions.

The RF pin is internally matched to 50 Ohm.

Picture: Evaluation board Thyone-I

EXTERNAL ANTENNA MATCHING

Performance Optimization

The matching of an external antenna, which can be a Multilayer Chip Antenna or even a RF-connector can be a simple process when the fundamentals of impedance measurement and matching are understood and a logical iterative process is followed. Würth Elektronik is offering not just the components for a matched Antenna Network, we can also support in the process of designing. Our RF-Design engineers will assist you with antenna matching and performance optimization during the design and testing phase of your wireless product.

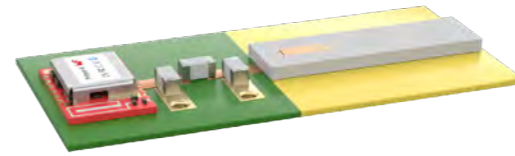

Radio Module with WE-MCA as antenna

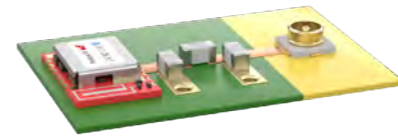

Radio Module with RF-connector

 [we-online.com/katalog/en/em/connectors/coax](https://www.we-online.com/katalog/en/em/connectors/coax)

Smith Chart

The WE-MCA Multilayer Chip Antenna has a very diverse applications portfolio when it comes to wireless data transfer on different frequencies.

With the help of the Smith chart, the antenna impedance, consisting of resistive and reactive components, can be easily represented graphically. In a perfectly matched antenna network, the impedance at the operating frequency of the antenna is in the middle of the Smith chart and therefore at 50Ω . This can be achieved by using RF inductors and/or capacitors. A pi network is particularly useful for this purpose, since it can be used very flexibly for antenna tuning at 50Ω from almost any other value.

Matching Circuit

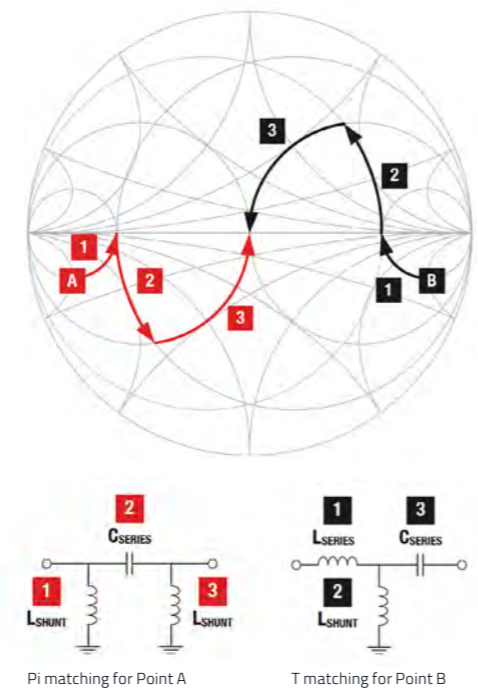

What we can offer you

- Simulation models
- Optimize antenna performance
- Antenna selection
- Matching circuit
- Antenna placement and positioning
- Measurement of reflection loss

OUR SERVICE & SUPPORT

- ✓ Frequency range of 400-6000 MHz
- ✓ Simulation models
- ✓ Optimized antenna performance
- ✓ Antenna selection
- ✓ Wide range of RF products
- ✓ Matching circuit
- ✓ Placing and matching of the antenna
- ✓ Measurement of the reflection loss

Contact our RF engineers today!

antenna.matching@we-online.com

WÜRTH ELEKTRONIK RF COMPONENTS

Multilayer Chip Antenna

- Extremely low profile
- Power capacity: 5 W max.
- Omni-directional
- Operating temperature: -40 C to $+85 \text{ C}$
- High gain
- Wireless communication applications: GSM, WLAN, Bluetooth,
- Home RF, IoT



Unlike custom designed PCB antennas, the WE-MCA has a consistent omnidirectional radiation pattern. This gives flexibility and variation in the positioning of the antenna in the application.

 [we-online.com/katalog/en/WE-MCA](https://www.we-online.com/katalog/en/WE-MCA)

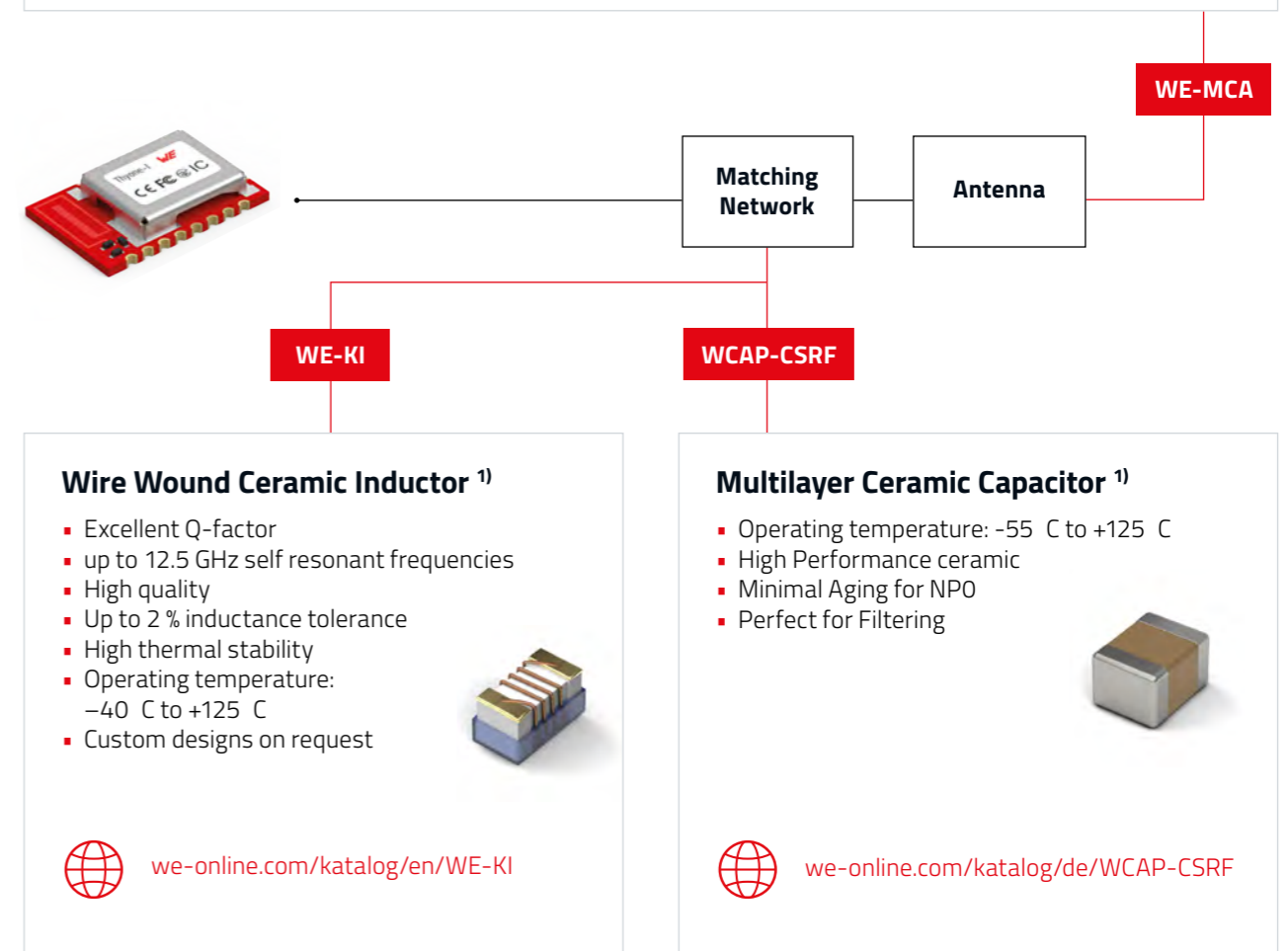

¹⁾ Modelithics® libraries available for Advanced Design System (ADS), Genesys and also for AWR Microwave Office

AppNotes

 **WE-MCA Multilayer Chip Antenna Placement & Matching**
[we-online.com/ANP057](https://www.we-online.com/ANP057)

 **LC Filter Design With MLCCs: Why The Applied Voltage Matters**
[we-online.com/ANP062](https://www.we-online.com/ANP062)

IMPROVE YOUR DESIGN

GET RID OF NOISE

Noise at 2.4 / 5.0 GHz

Noise can interfere with the extremely sensitive wireless channels operating at 2.4 / 5.0 GHz bands. Therefore it is important to consider a holistic design of the full application.

Communication Interfaces – source of noise

Noise can interfere with the extremely sensitive wireless channels operating at 2.4 / 5.0 GHz bands.

- Communication interfaces radiate noise on a very broad spectrum which can interfere with the Wi-Fi signal
- This can lead to loss of the Wi-Fi signal

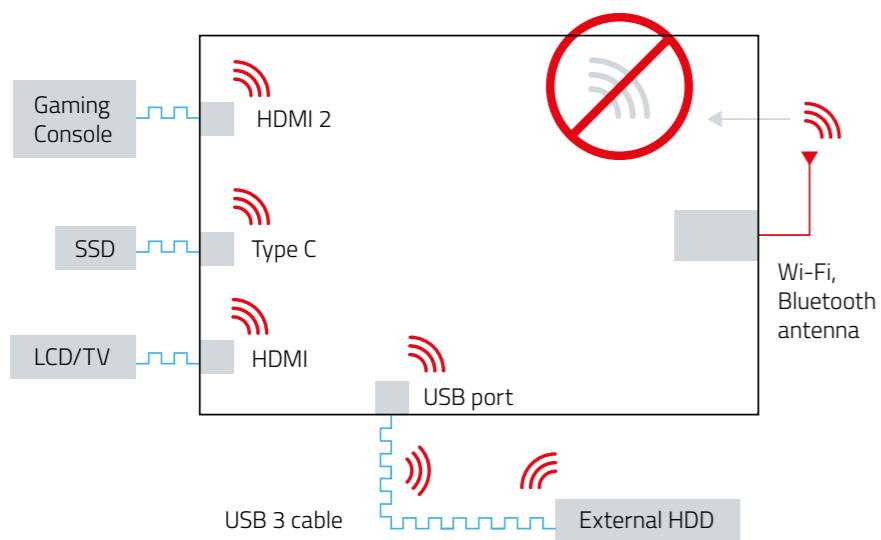

Signal Integrity and Increase in Data Speed of Highspeed interfaces

Signal integrity defines the quality of an electrical signal and refers to the challenges that arise due to high frequency data transmission. With the high switching speeds of the modern digital I/O interfaces, we are now able to achieve high data rates and bandwidth. At the same time, noise is a big concern for the integrity of these high frequency digital signals.

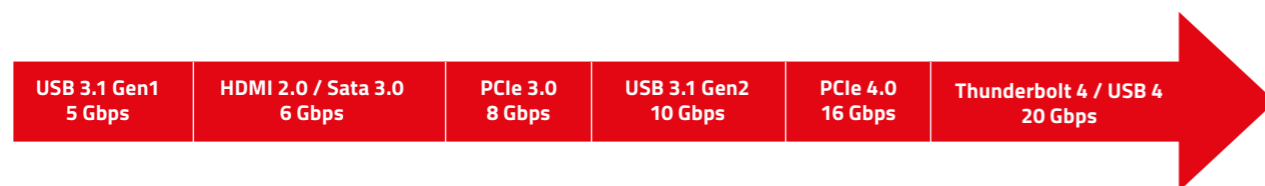

Common Mode Chokes - reduce emissions, increase noise immunity

Common mode Filters/Chokes are a very effective way of protecting the data lines against noise interference, while reducing emissions at the same time. Choosing the appropriate common mode choke for a high-speed differential interface requires knowledge about both the application and the filter itself.

WE-CCMF

Ceramic Common Mode Filter:

- Ceramic based choke that works on the principle of the transmission line theory
- Complex inner resonant structure ensures high common mode suppression at wireless frequencies (2.4 & 5.0 GHz)
- Keeps the differential signal intact

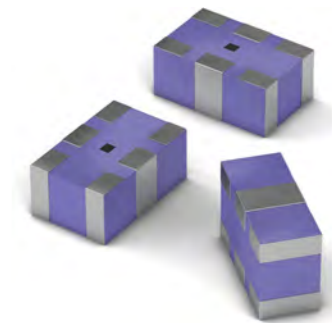

we-online.com/katalog/en/WE-CCMF

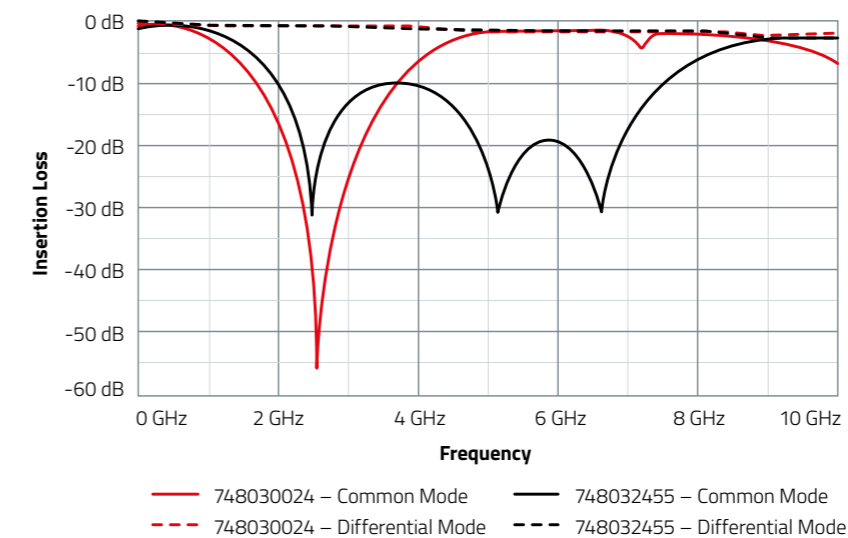

FIRMWARE: WE-PROWARE AS OPERATING SYSTEM

EXAMPLE: BLE Module

Fully featured & "BLE qualified" software stack

SPP-like profile (TX & RX characteristic) DIS, Security Modes, Bonding, FOTA, Automatic BLE Role switch, Low Power Optimization

WE-PROWARE

Individualization of parameters to match customer applications e.g. configuration of
 → UART baudrate
 → RF output power

EXAMPLE: Proprietary Module

Fixed hardware design "RF module"
 → Small formfactor
 → Robust RF modules

Offers Easy-to-Use Command Interface among other features

More on page 74

FIRMWARE: WE-PROWARE

One solution with full flexibility

Our Firmware and radio stack WE-ProWare offers full flexibility through the possibility of using different radio profiles and/or interfaces while being an off-the-shelf software code to enter the wireless world immediately. For a simple integration we offer an API to match your needs with the offerings from the Firmware WE-ProWare

Profiles

Instead of writing software code, select options (=profiles). The usable profiles offer high flexibility in:

- Network topology
- Data rate
- Throughput
- Range
- Energy consumption

API (Application Programming Interface)

- Offers communication directly to the module
- Simple AT-Commands, well known and usable with nearly every microcontroller, regardless of its size

Radio Stack

- Bluetooth® LE Stack for easy communication with Smart Devices
- Wi-Fi Stack guarantees high data rates and IP based communication
- Proprietary stack developed for industrial and medical requirements
- LTE cellular radio stack for global connectivity

Interface

Different Interfaces available suiting every application:

- UART
- SPI
- I²C

RADIO STACK & FIRMWARE OPTIONS

The best Wireless Solution for you – You can choose between the following options:

1. STANDARD FIRMWARE

- RF Module comes with a standardized firmware
- RF Module is subject to further firmware development
- 100% verified, electrical tested and validated
- update functionality given (UART, FOTA, ...)
- packaged in Tape & Reel, ESD und MSL conform



2. BUILD YOUR OWN FIRMWARE

Get every module without WE Firmware to bring your own solution on it.

- RF Module comes without any standardized firmware
- 100% electrical testing on customer request
- RF Module will have a standard part number
- packaged in Tape & Reel, ESD und MSL conform



3. FIRMWARE FREEZE

A firmware freeze guarantees a static behaviour of the module and no change in the module at all.

- RF Module comes with a standardized firmware
- RF Module is NOT subject to further firmware development
- RF Module will have a fixed revision of the firmware e.g. 1.3.1
- RF Module will have a unique part number
- 100% verified, electrical tested and validated
- packaged in Tape & Reel, ESD und MSL conform

4. CUSTOM

A fully customized product with your dedicated application implemented on the module. This might require Würth Elektronik to offer design consultancy services and the product is not available ex stock.

- RF Module comes with a custom firmware
- RF Module will have a unique part number
- 100% electrical testing on customer request
- packaged in Tape & Reel, ESD und MSL conform
- we can upload your Firmware in our production process to the WE Hardware



A special service for every customer:

5. INDIVIDUALIZED ADAPTION (USER SETTINGS)

We align our standard firmware to your requirements which simplifies your production process.

- RF Module comes with a standard firmware
- User Settings adaptations defined by customer
- Continuous & further firmware development only on customer request
- Individualized Adaption (User Settings)
- Firmware freeze on customer request
- RF Module will have a unique part number
- 100% verified and electrical tested
- packaged in Tape & Reel, ESD und MSL conform

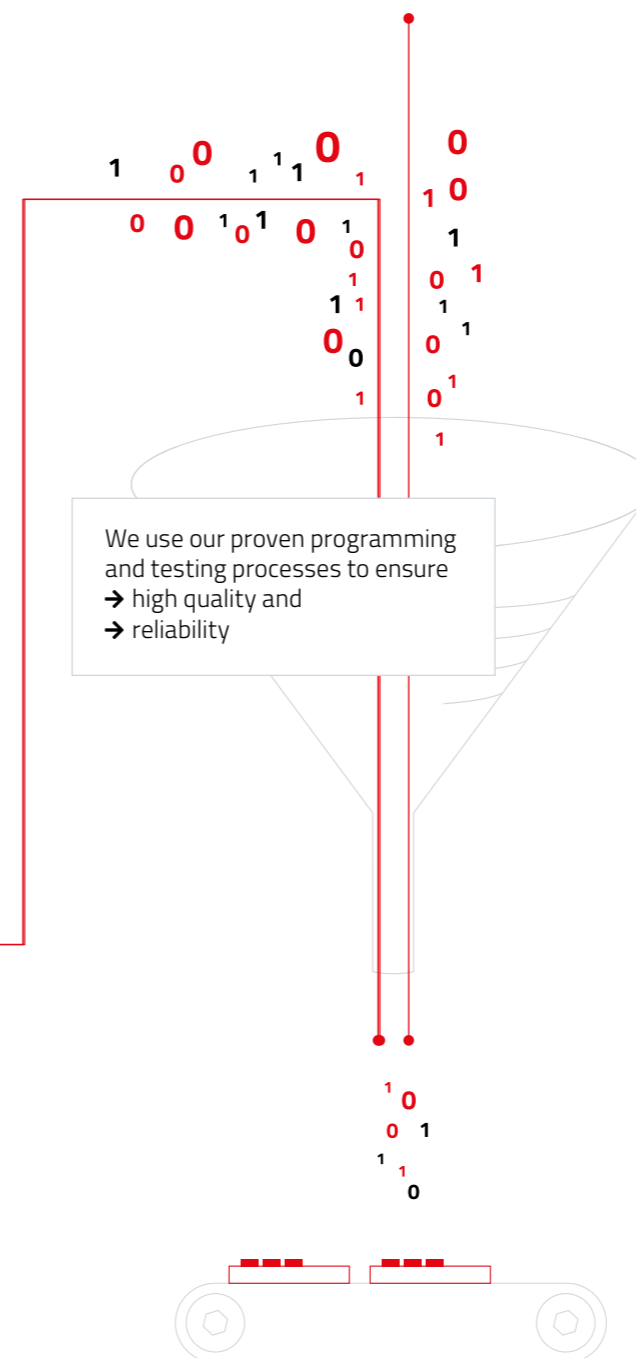

Exemplary UserSettings

Setting	Calypso	Proteus
Advertising timing		✓
Beacon options		✓
Connection timing		✓
Device Name		✓
Device Information Service Options/Fields		
High Throughput mode on/off		
Profile Options (Base UUID)		✓
Scan options		✓
Long Range Connect		
WLAN country (EU, US, JP)	✓	
WLAN mode (STA, P2P/wifi direct)	✓	
WLAN P2P Parameters	✓	
WLAN Policy (Power, Connection)	✓	
WLAN Provisioning Parameters *	✓	
SNTP Time Servers	✓	
WLAN STA Profile(s)	✓	
Radio TX Power	✓	✓
Security options	✓	✓
Sniffer mode on/off		
StaticPasskey (128 bit)		✓
UART data rate		✓
UART data rate+parity	✓	
UART flow control on/off (RTS/CTS)		✓
OpMode (Command or Transparent UART)		✓
Clear Channel Assessment/Listen before Talk		
GPIO control		
UART data rate		
satellite system selection		
Protocol (NMEA or OSP)		
update rate (typ. 1Hz)		
Firmware description (e.g. Customer name)		
Secure Boot Key	✓	
Image Authentication Key	✓	✓

Do you have a need for one of the mentioned customizations? Get in contact with us. We will find out, what fits best for you! Contact your local sales or email to: wireless-sales@we-online.com

WIRELESS GUIDE







How to find the suiting product?

This Wireless Guide will help you to find a solution for your application! Answer the following questions, as far as you can and with the information in the last pages, you will be able to take a decision.

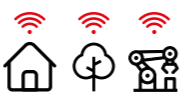

If there is any need of support: Contact us!

wireless-sales@we-online.com

1. Region	2. Range	3. Environment	4. Data	5. Energy	6. Interface
					
In which region will the application run or should be used in the future?	What range do you need to cover in your application?	In which environment will your application be used?	How much data has to be transmitted? Which data rate is required?	What about power consumption? How much energy is available? How long should a battery last?	Communication to...?
<input type="checkbox"/> Europe <input type="checkbox"/> North America <input type="checkbox"/> South America <input type="checkbox"/> Asia <input type="checkbox"/> worldwide <input type="checkbox"/> other: _____	<input type="checkbox"/> 0 - 15 m <input type="checkbox"/> 15 - 50 m <input type="checkbox"/> 50 - 100 m <input type="checkbox"/> 100 - 500 m <input type="checkbox"/> 500 m - 2 km <input type="checkbox"/> 2 km - 10 km <input type="checkbox"/> >10 km	<input type="checkbox"/> Indoor <input type="checkbox"/> Outdoor <input type="checkbox"/> Industrial <input type="checkbox"/> Home Automation <input type="checkbox"/> other: _____	<input type="checkbox"/> Very low data rate (up to 1 kbps) <input type="checkbox"/> Middle data rate (up to 100 kbps) <input type="checkbox"/> High data rate (>100 kbps) <input type="checkbox"/> Very high data rate (>500 kbps)	<input type="checkbox"/> Long term battery powered <input type="checkbox"/> Battery powered <input type="checkbox"/> Main powered <input type="checkbox"/> other: _____	<input type="checkbox"/> Smart Device (Mobile, Tablet) <input type="checkbox"/> PC, Server, etc. <input type="checkbox"/> Device of own development <input type="checkbox"/> Special communication interface (Wirepas, wM-Bus, CAN-Bus, ...) <input type="checkbox"/> Mesh (Wirepas, Bluetooth® Mesh, Closed Mesh) <input type="checkbox"/> other: _____



CELLULAR



INTRODUCTION	35
PRODUCT OVERVIEW	40
ADDED VALUES	44

INTRODUCTION

Cellular - an Overview

LTE (Long Term Evolution) is a Cellular communication standard, which operates in licensed spectrum. LTE is also referred to as fourth generation ("4G") of cellular communication technology. The standards for LTE are defined by 3rd Generation Partnership Project (3GPP). 3GPP is a worldwide standards organization that develops protocols/standards for cellular telecommunications.

LPWAN cellular technologies are for low-power, low transmitting speeds, low-cost module and devices, with low data usage per month, and wide area coverage. Existing cellular technologies were not designed to cater low power application, hence cellular LPWAN technologies covers scenarios for which existing mobile network technology is not suitable. These cellular LPWAN refers to low power wide area networks (LPWAN) in licensed spectrum.

3GPP specified LTE-M (LTE-MTC) and NB-IoT (Narrow-Band IoT) to address the fast-expanding market for low power wide area network (LPWAN) connectivity.

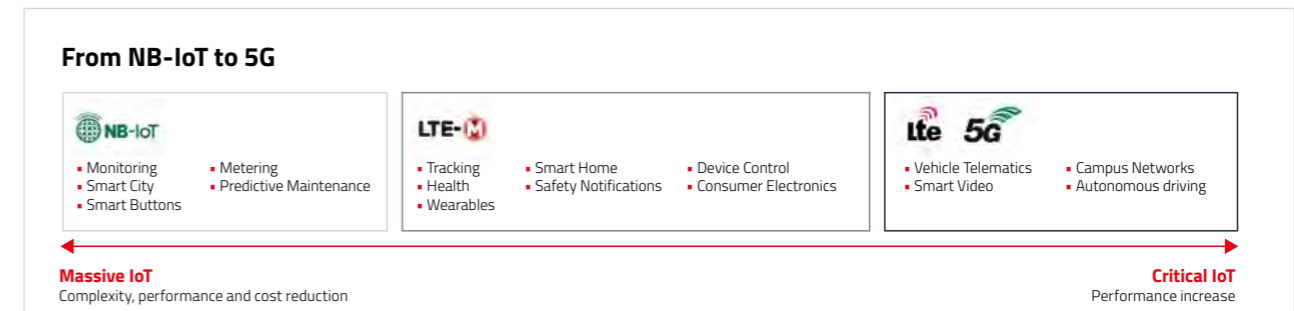
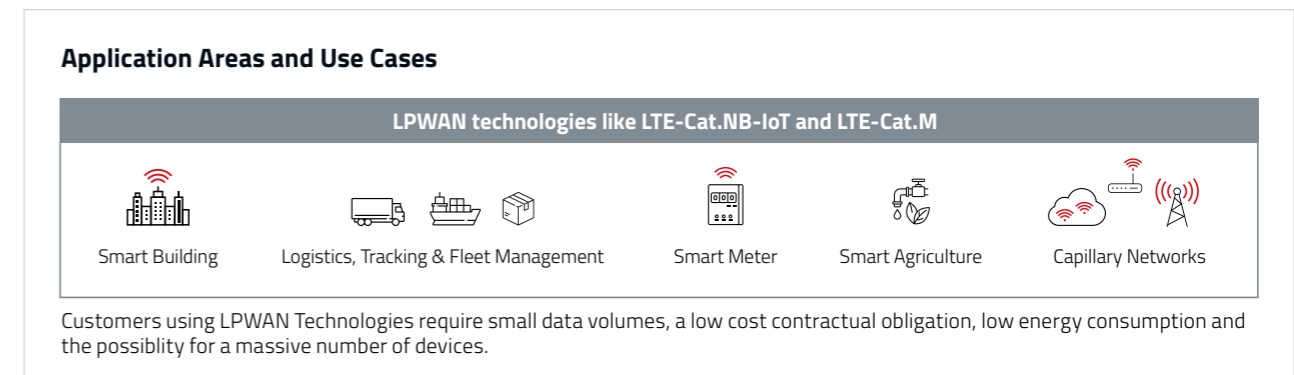
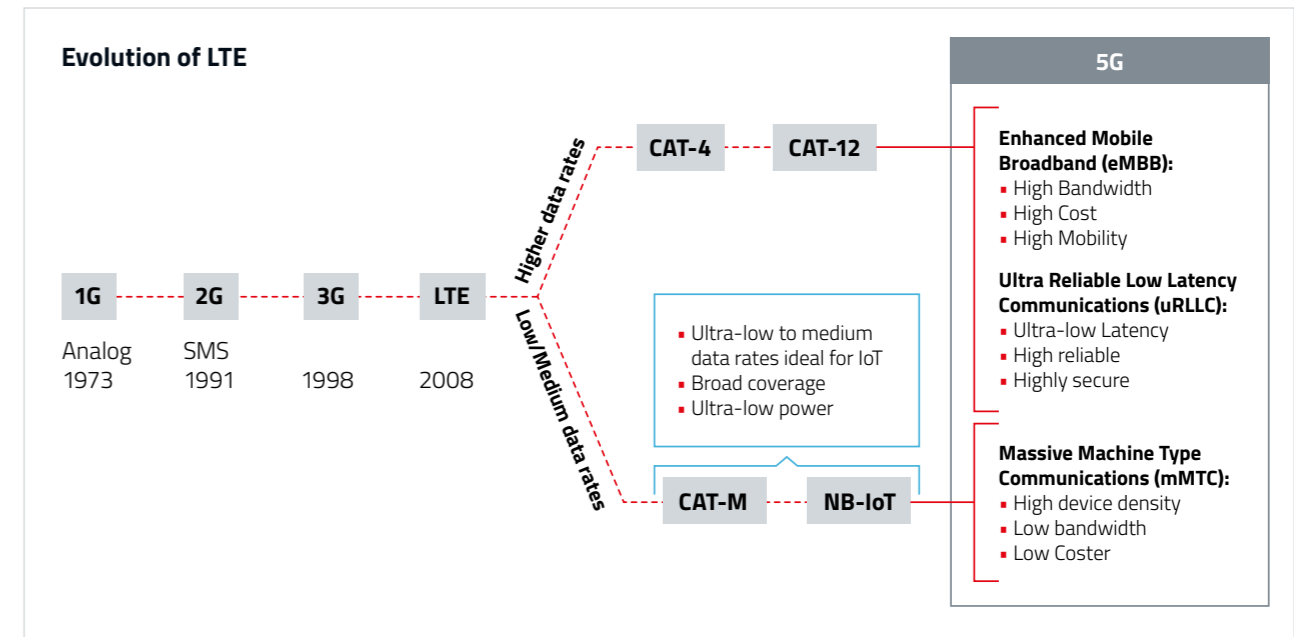

IOT CONNECTIVITY OPTIONS

The right choice

The main purpose of any IoT solution is to get data from the field to the cloud where analysis of the same generates the desired value proposition for the application. With a wide range of IoT connectivity options available, the connectivity decision is increasingly based on the cost, security, coverage, power usage and the potential throughput of the connectivity. Multiple IoT connectivity options are available and at the broader level these solutions can be categorized into two types:

- a) Short Range wireless connectivity solutions and
- b) Long Range wireless connectivity solutions

For few applications both short range and long range solutions can fit but application's requirements and environments determines which connectivity solution shall be used.

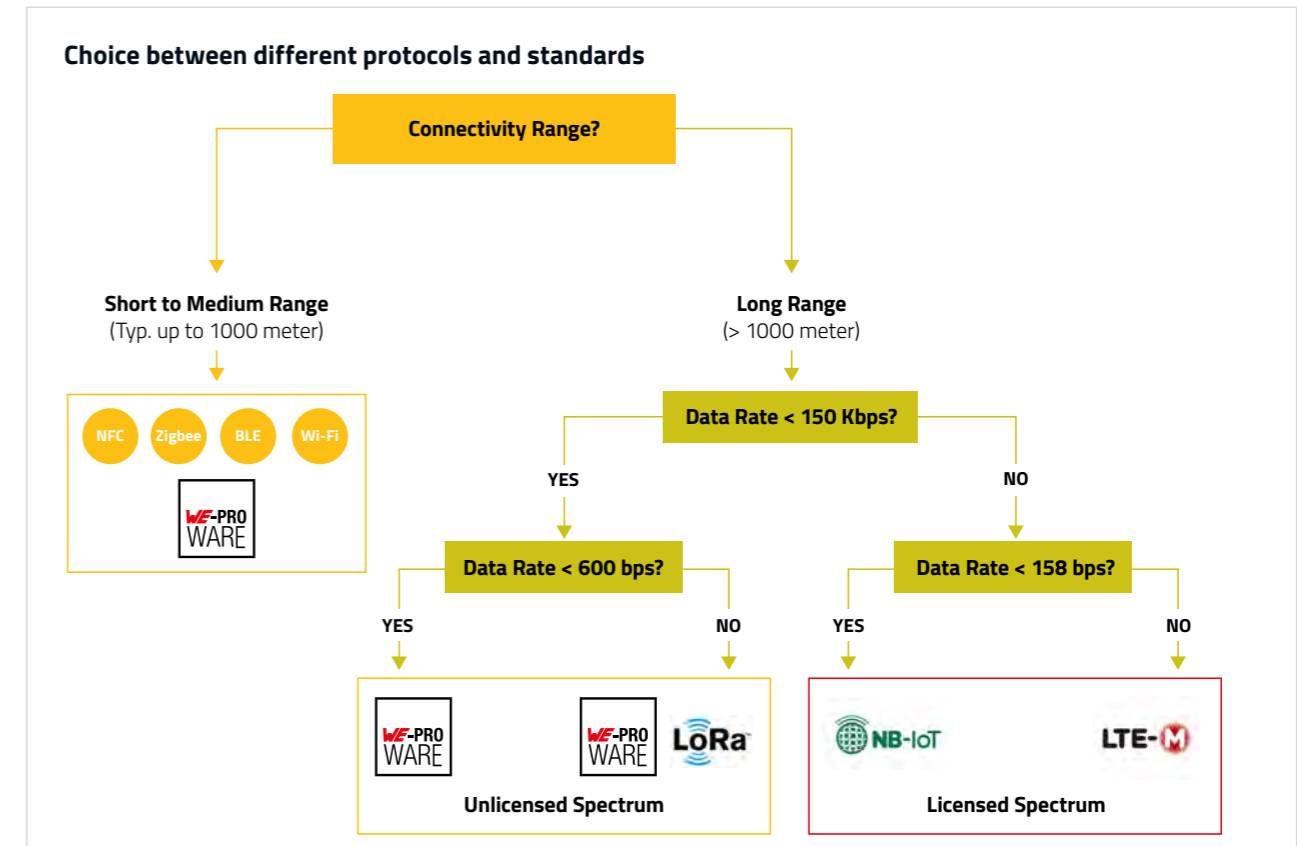
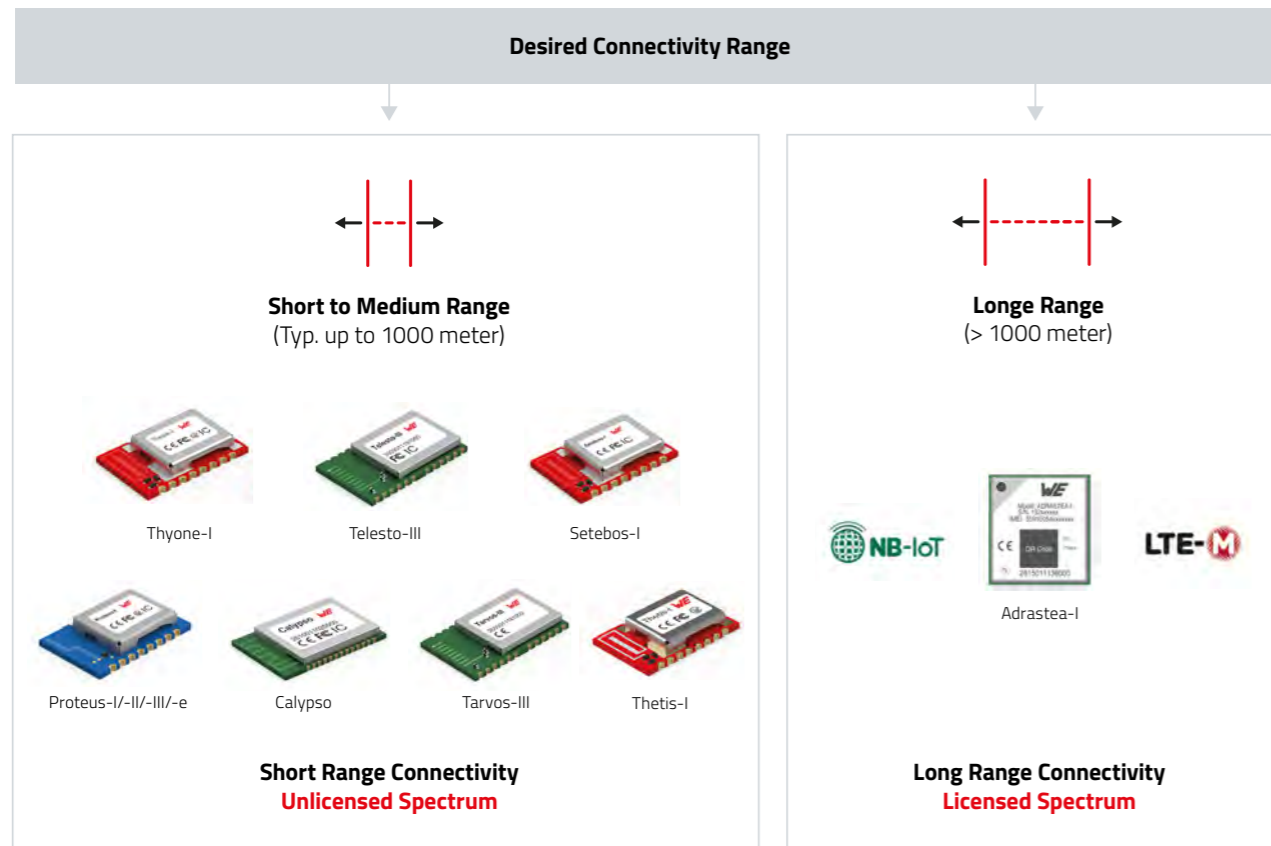
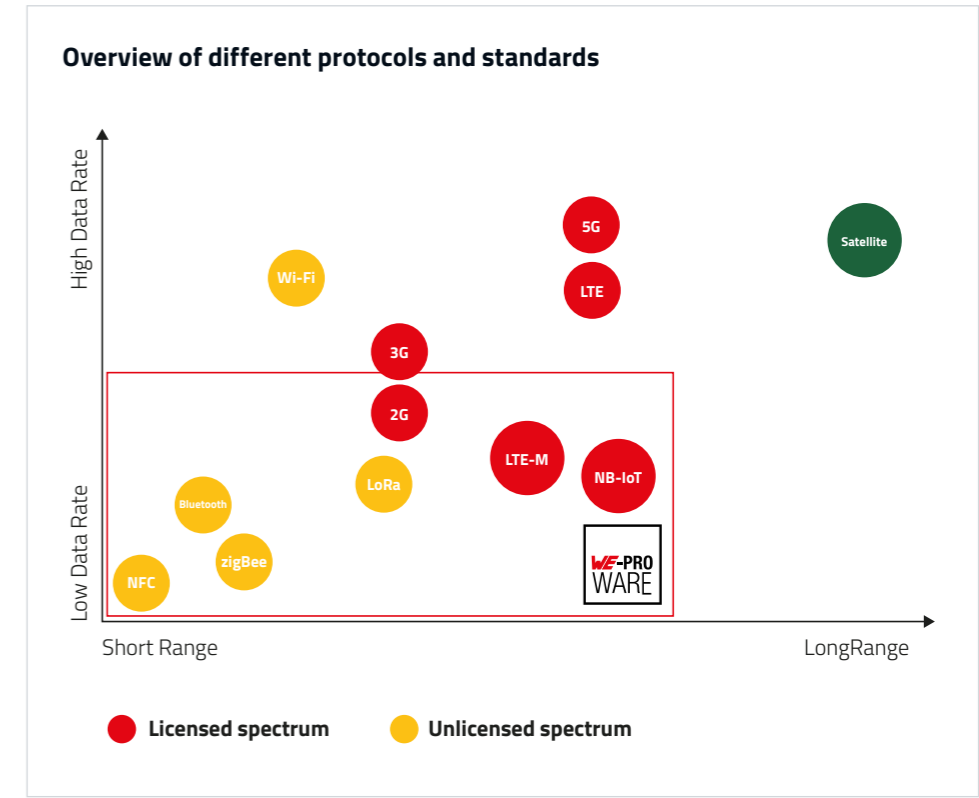
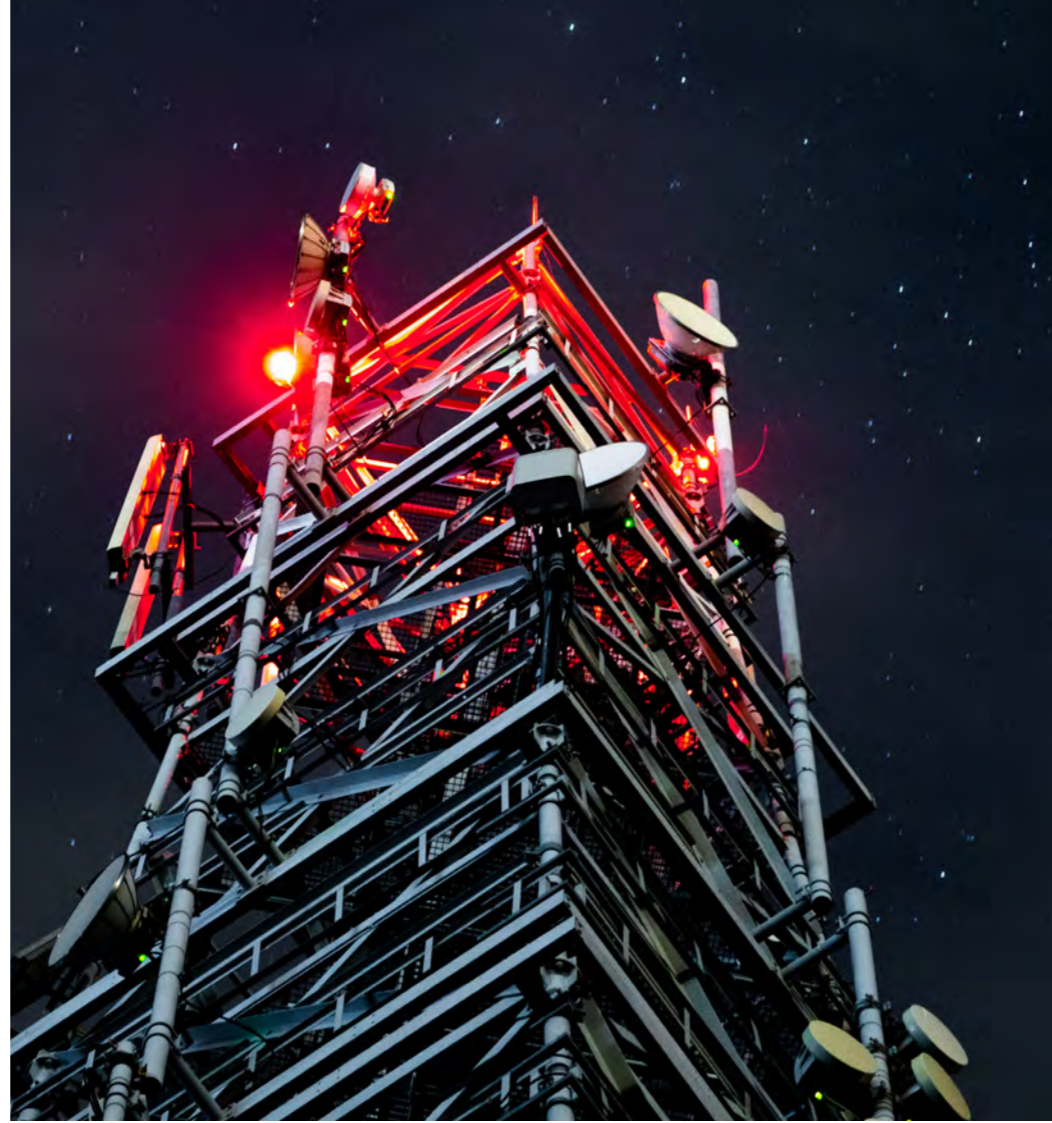

- Cellular
- Bluetooth®
- Wi-Fi
- Proprietary
- Combined
- Mesh
- Wireless M-Bus
- Build Your Own Firmware
- GNSS
- Sensors



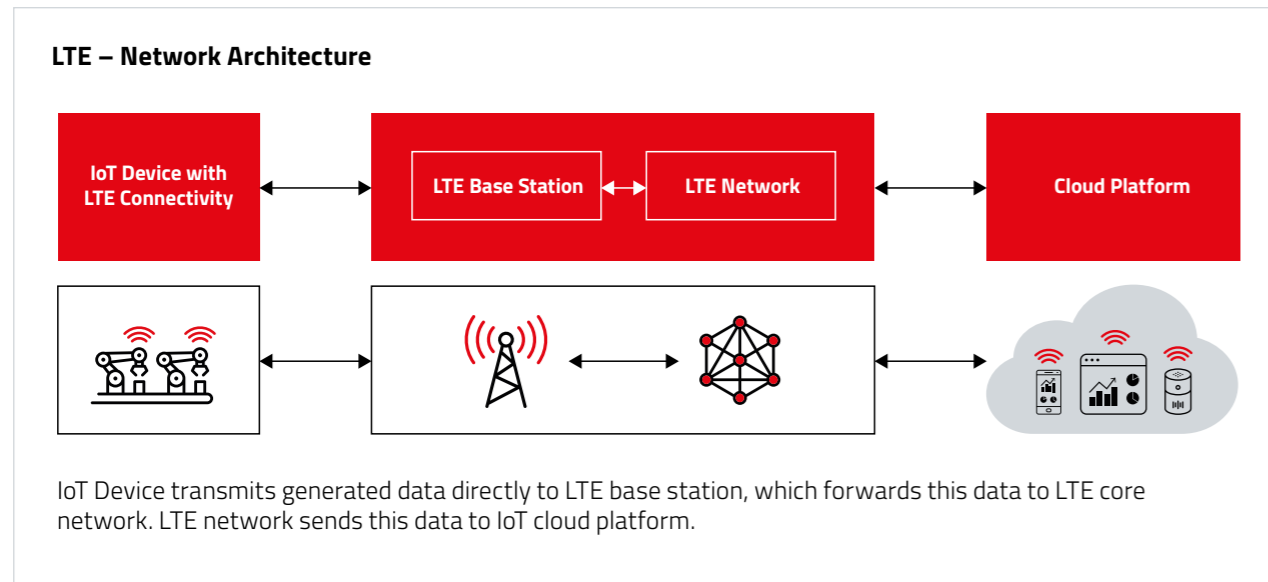

GENERAL INFORMATION



Example:

An industrial machine equipped with sensors, which collects the data on a wide range of parameters that determines its health and performance, for example, temperature, pressure, vibration frequency. This collected data is transmitted to LTE base station. LTE base station forwards this data to LTE core network. LTE network passes over this data to the cloud platform.

Advantages of Cellular Networks

- 
Global Coverage and Roaming: Cellular networks are available globally, global coverage of cellular technologies makes companies to deploy their IoT devices globally. In-addition global presence of cellular networks enables roaming and mobility.
- 
Secure and Reliable Transmission: Cellular technologies have default security procedures enabled, this procedure make sure only certified, subscribed and authenticated devices can access mobile network for data, SMS and voice services.
- 
Standardized: 3rd Generation Partnership Project (3GPP) develops standards for cellular communication. These standards are internationally agreed standards. The device manufactures and network service providers follows cellular communication standards.
- 
Network Quality of Service: Licensed spectrum is assigned exclusively to network service providers for independent usage. In this licensed spectrum service provider deploys his network. IoT devices has to subscribe for data or SMS services to network service provider, they are contractually bound to provide quality of Service for subscribers.
- 
Certified Device Access: Certified devices access the cellular network this enables efficient utilization of licensed spectrum and minimizes the risk. Secured connectivity and strong authentication of IoT devices.

LTE-M and NB-IoT

Both LTE-M and NB-IoT are two new standards of Radio Access Technology designed for Low Power Wide Area Networks (LPWAN), which are very energy-efficient radio transmission technologies. LTE-M and NB-IoT features low power consumption, wide coverage, massive connectivity and lower cost. LTE-M and NB-IoT enable a wide range of IoT applications where low cost, low power consumption and good building penetration are important.

Generally, NB-IoT is suitable for applications that only need to transmit small data volumes. NB-IoT offers maximum uplink data rate 158 Kbps. This data rate is adequate for transmitting the sensor generated data such as Temperature, pressure, filling levels etc.

LTE-M fills the gaps where NB-IoT is no longer sufficient or where NB-IoT is not available. For example, LTE-M has a higher uplink data rate of up to 1 Mbit/s and can thus transmit a large amount of data in less time. LTE-M is suitable for asset tracking type of applications where higher data rate with mobility support is required.

Difference between LTE-M and NB-IoT

	NB-IoT	LTE-M
Bandwidth	180 KHz	1.08 MHz
Max Uplink Peak data rate	158 Kbps	1 Mbps
Max Downlink Peak data rate	127 Kbps	588 Kbps
Power Consumption	Best for sending small data	Best for sending large messages
Voice Support (VoLTE)	No	Yes
Latency	High	Low
Mobility	No connected mobility – for stationary devices	Full mobility support – for asset tracking applications
Deployment Type	In-band LTE, LTE guard bands, Stand-alone	In-band LTE

	Firmware updates	Indoor coverage	Remote control devices	Suitability for moving devices	Possibility to grow with new use cases
LTE-M	●●●	●●●	●●●	●●●	●●●
NB-IoT	●	●●●	●●	●	●

	Low latency	Indoor coverage	Data rate	Battery lifetime	Suitability for moving devices
LTE	●●●	●	●●●	●	●●●
LTE-M	●●	●●	●●	●●	●●
NB-IoT	●	●●●	●	●●●	●

CELLULAR MODULE



Adrastea-I

LTE-M / NB-IoT Cellular Module



Characteristics

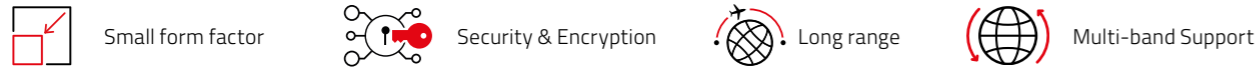

- Flexible mode selection as LTE Cat M/NB-IoT
- LTE-Cat.M supported bands: B2/B3/B4/B5/B8/B12/B20/B25/B26/B28
- NB-IoT supported bands: B3/B5/B8/B20/B28
- 3GPP Release 13 compliant, Upgradable to Release 14
- Small form factor: 13.4 x 14.6 x 1.85 mm
- Integrates GNSS (Supports GPS, GLONASS)
- Integrated user MCU exclusively for customer application development (ARM Cortex-M4, 1MB Flash, 256 KB RAM)
- Output Power class 3 (23 dBm)
- Supports 3GPP TS27.005, 27.007 and Würth Elektronik enhanced AT commands
- Protocols: IPv4/IPv6, TCP/UDP, HTTP/HTTPS, TLS/DTLS, MQTT, LWM2M
- Low Power consumption and longer battery life
- Adrastea Commander Tool (Evaluation tool for Cellular modules)

Key Features

Interfaces		Protocols	
✓ USM	✓ GPIO	✓ IPV4/IPV6	✓ HTTP/HTTPS
✓ UART	✓ ADC	✓ TCP/UDP	✓ MQTT
✓ I ² C	✓ JTAG	✓ TLS/DTLS	✓ LwM2M
✓ SPI		✓ COAP	

Other Features

- Maximum Data Rate (LTE-Cat.M1):
 - Downlink: 300 Kbps
 - Uplink: 375 Kbps
- Maximum Data Rate (LTE-Cat.NB1):
 - Downlink: 127 Kbps
 - Uplink: 158 Kbps
- Firmware upgrade over USB interface
- Firmware upgrade over air

Comparing Adrastea-I with GNSS Modules

Feature	Adrastea-I	Elara-I	Elara-II	Erinome-I	Erinome-II
Dimensions	13.4 x 14.6 mm	10 x 10 mm	4 x 4 mm	18 x 18 mm	7 x 7 mm
GNSS Constellations Supported	GPS, GLONASS	GPS, GLONASS	GPS, GLONASS	GPS, GLONASS, Galileo, BeiDou	GPS, GLONASS, Galileo, BeiDou
Maximum number of Concurrent GNSS	2	2	2	3	3
Antenna Type	External Antenna	Integrated Antenna	External Antenna	Integrated Antenna	External Antenna
Time To First Fix (Cold Start)	36 sec	28 sec	28 sec	28 sec	28 sec
Time To First Fix (Hot Start)	1 sec	1 sec	1 sec	1 sec	1 sec
Rx Sensitivity (Cold Start)	-145 dBm	-148 dBm	-148 dBm	-148 dBm	-147 dBm
Power Supply	3.6	1.8	1.8	1.8	1.8
Current Consumption (Acquisition)	54 mA	55 mA	52 mA	55 mA	55 mA
Accuracy (Tracking mode)	1.5 m	1.5 m	1.5 m	1.5 m	1.5 m
Default Module Operation	LTE (GNSS activated with AT command)	GNSS	GNSS	GNSS	GNSS
External Connectivity Module Required	NO	YES	YES	YES	YES

Supported Cellular Technologies

Benefits of Dual Mode:

Enable international multi-regional coverage (In some country (region) LTE-M is not available then Module will select NB-IoT and vice versa)



Integrated MCU (Exclusively for Customer Application's Firmware)

Benefits of Integrated MCU:

- ✓ Cost (External micro controller is not required)
- ✓ Size
- ✓ Power Consumption



Positioning

Benefits of Integrated MCU:

Adrastea-I supports GPS and GLONASS satellite systems. This allows GNSS positioning for asset management applications where infrequent position updates are required.

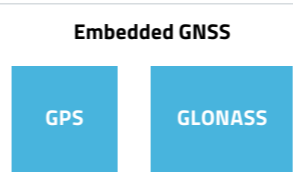

CERTIFICATION

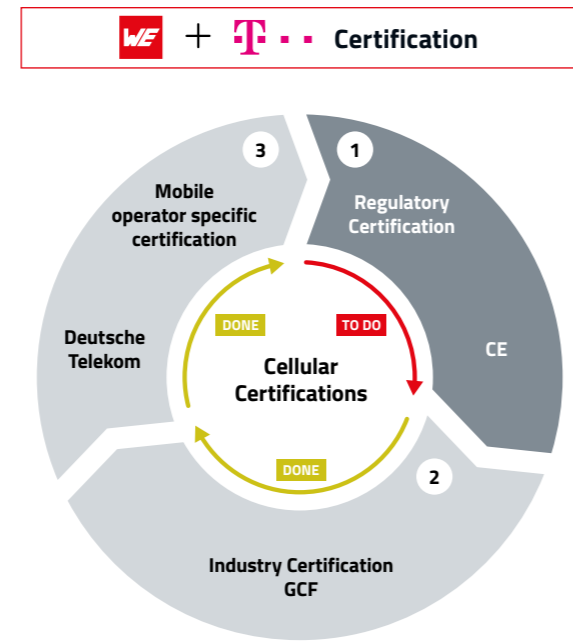
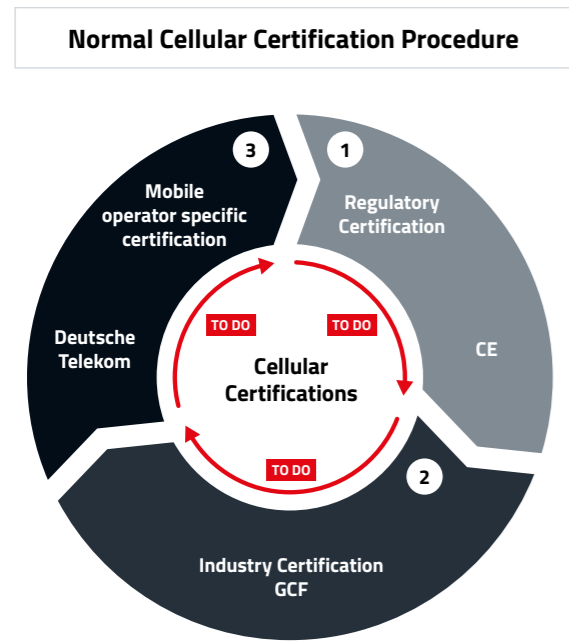

Regulatory Certification: Country specific to comply with country's regulations. Testing covers Safety aspects, RF emissions do not interfere with other wireless equipment's (e.g. RF transmitter and receiver tests, EMC, Electrical safety and environmental).

Industry Certification: The Global Certification Forum (GCF) is a certification organization in which manufacturers, operators and test laboratories deal with the compliance of devices in mobile networks with 3GPP standards and specifications.

Mobile operator specific certification: Testing specific to their network configuration and network parameter settings. This testing is focusing on field performance of the devices, such as radio sensitivity, data throughput.

Normal Cellular Certification Procedure

2 Types of Certification are mandatory for End Product:

1. Regulatory Certification: CE
2. Network Operator Certification: Vodafone, Deutsche Telekom etc.

End Product with Cellular Module

WE - Deutsche Telekom Certification

Certification is mandatory for End Product:

1. Regulatory Certification: CE

End Product with WE-DTAG Certified Module

Benefits of WE - Deutsche Telekom Certified Module

- Be smart** and ensure that your product does not require certification again.
- Obtain assurance** – Pre-certified module reduces final test effort.
- Save time and money** – the end product does not require to go through complex cellular certification process again

DTAG Coverage: Europe

Country	Operator	LTE-M	NB-IoT
Germany	Deutsche Telekom	✓	✓
	Vodafone	✓	✓
	Telefonica	✓	✓
Netherlands	T-Mobile	✓	✓
	Vodafone Libertel	✓	✓
Belgium	Orange	✓	✓
	Telenet		✓
Austria	Magenta Telekom	✓	✓
Slovenia	A1 Slovenija		✓
Luxembourg	Post Luxembourg	✓	
Switzerland	Swisscom	✓	✓
Czech Republic	T-Mobile Czech		✓
Slovakia	Slovak Telekom		✓
Poland	T-Mobile Poland		✓
Italy	Vodafone		✓
	TIM		✓

Country	Operator	LTE-M	NB-IoT
Denmark	Telia	✓	✓
	Telenor	✓	
Finland	DNA	✓	
	Telia	✓	✓
Norway	Telenor	✓	
	Telia	✓	✓
Sweden	Telia	✓	✓
	Tele2	✓	
	Telenor	✓	
Spain	Orange	✓	
	Vodafone		✓
Croatia	Hrvatski Telekom		✓
Hungary	Magyar Telekom		✓
Greece	Cosmote		✓
Liechtenstein	Swisscom	✓	
Denmark	Telia	✓	✓
Latvia	LMT	✓	
Malta	Melita LTD		✓

DTAG Coverage: Non - Europe

Country	Operator	LTE-M	NB-IoT
USA	T-Mobile US	✓	✓
	AT&T	✓	
Canada	Bell Mobility	✓	
South Korea	KT Corporation	✓	
Japan	NTT DoCoMo	✓	
New Zealand	Spark	✓	
Taiwan	Chunghwa Telecom	✓	✓
Russia	MTS Mobile TeleSystems		✓
UK	Vodafone		✓
	JT (Jersey) Limited	✓	

WE Cellular Solution

Adrastea-I:
LTE-Cat.M and NB-IoT Module

Connectivity:
IoT SIM Cards

IoT Platform:
Any public cloud

iotcreators.com/wuerth/

ADDED VALUES

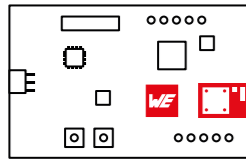

Eval Boards

- Easy testing
- Rapid prototyping
- FTDI integrated (UART to USB)
- Pins available on header
- Current measurement
- Nano SIM card holder



we-online.com/EVAL-Cellular



More information on page 150



Adrastea Commander

- Complete control of module over UART
- Evaluate GNSS functionality of module
- URL to access the WE-DTAG connectivity portal
- Approximate data consumption calculator
- Save and execute AT commands
- Run sequence of AT commands



we-online.com/Adrastea-Commander

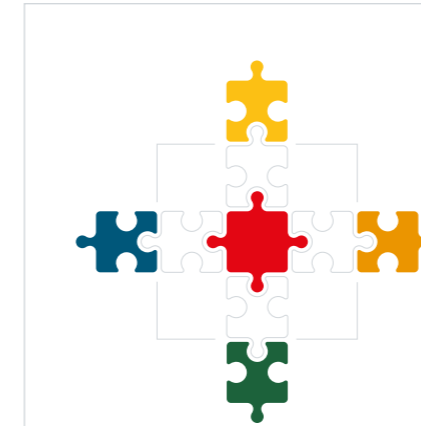
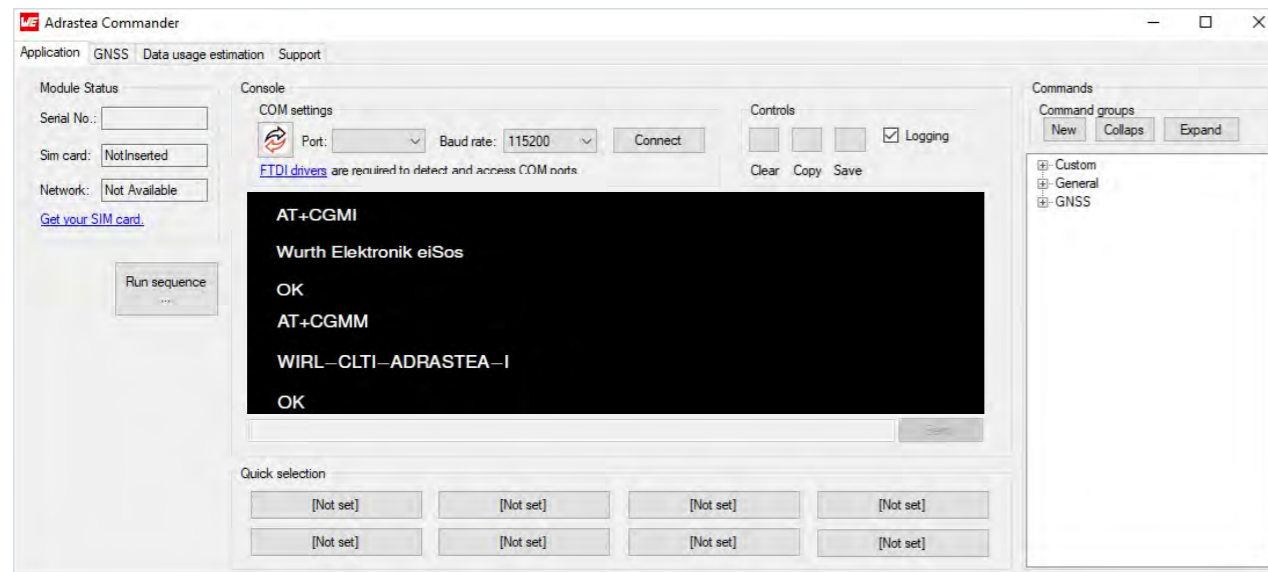

Software Development Kit

Adrastea-I cellular module has integrated ARM Cortex M4 MCU exclusive for end product applications. The MCU SDK from Sony allows software developers to write their own applications directly onto the Adrastea-I internal application MCU. SDK have several examples on how to develop your own application. These examples can be used as a reference code or as a starting point for a customer to develop his own application. Each example is a simple application that demonstrates the usage of a specific interface.

- Detailed documentation from Sony for easy Development Environment
- Reference examples
- Typically C-Language Files



we-online.com/WCO-SDK

BLUETOOTH®



OVERVIEW

The Origin of the Name Bluetooth® – an Example of Harmonization of Different Languages

Surprisingly, the name dates back more than a millennia to King Harald "Bluetooth" Gormsson who was well known for two things: Uniting Denmark and Norway in 958 and uniting several languages. His dead tooth, which had a dark blue/grey color, earned him the nickname Bluetooth. That way, the Bluetooth-Logo was created out of the runes for H and B.

$$\begin{array}{c}
 * \\
 \text{Nordic H}
 \end{array}
 +
 \begin{array}{c}
 \text{B} \\
 \text{Nordic B}
 \end{array}
 =
 \begin{array}{c}
 * \\
 \text{Bluetooth}
 \end{array}$$

As the aim of Harald was to unite countries and languages the aim of the Bluetooth® interface was to harmonise the communication between different electronic devices.

Bluetooth® – Harmonization of Interfaces

In 1996, three industry leaders, Intel, Ericsson and Nokia, met to plan the standardization of this short-range radio technology to support connectivity and collaboration between different products and industries.

The Amount of Devices is rising steadily

With the success of Bluetooth® connectivity also the number of devices is rising steadily. In 2019 about 4 billion Bluetooth® devices were shipped worldwide. The early classic standard is decreasing while Bluetooth® Smart or also called Bluetooth® Low Energy is fast-growing. Bluetooth® can be found of course in every Phone, Tablet and PC. Connected Devices, Smart Building, Smart Industry, Smart Home and Smart City are the key markets for Bluetooth® Applications.

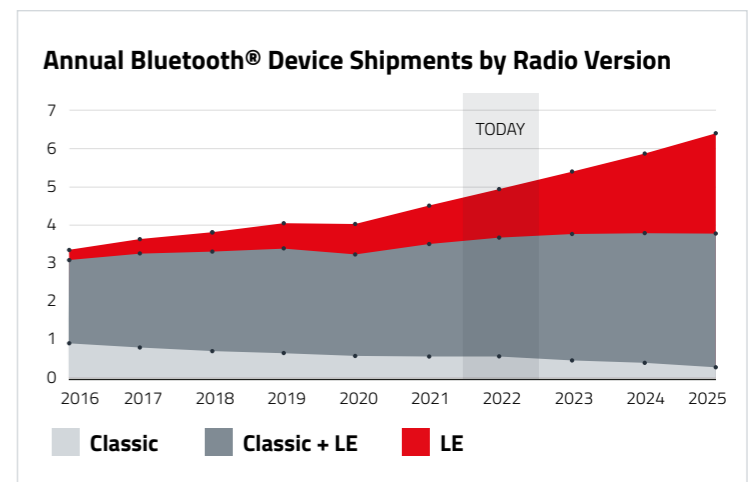

Bluetooth® as Industrial Communication Interface

Especially in the industry there is a need for easy connecting to different devices by Phone or Tablet. With no need of a display in the device itself, as the Smart Device is used for it, an immense potential of cost reduction is reachable.

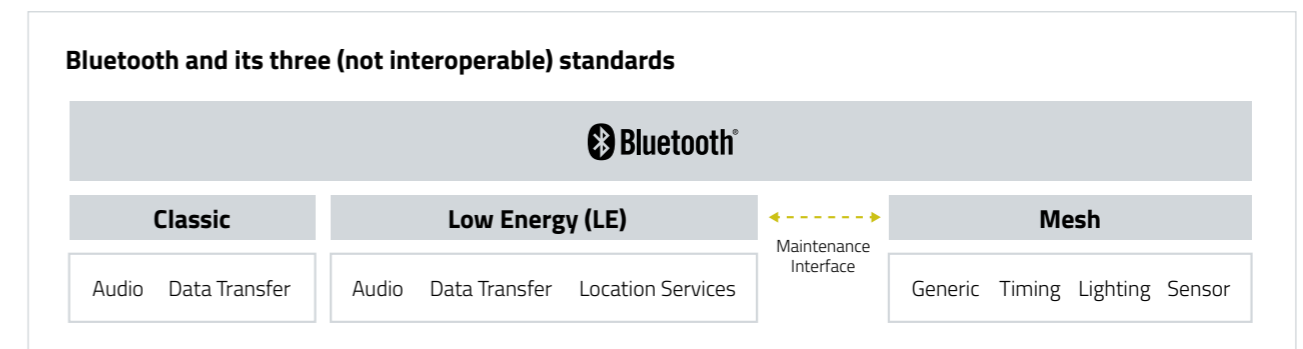

INTRODUCTION 47

PRODUCT OVERVIEW 53

ADDED VALUES 58

BLUETOOTH® STANDARDS & VERSIONS

Bluetooth® Classic

- Introduced in Bluetooth® version 1.0
- Bluetooth® Classic versions are backward compatible
- 79 channels with 1MHz bandwidth (2.402 – 2.480 GHz)
- One master, up to 7 slaves
- Time (TDMA) and frequency (FHSS) synchronization done by master
- Slave may send data only if polled by master
- Last enhanced version 3.0. still available but not updated any more



Bluetooth® Low Energy

- Defined from Bluetooth® version 4.0 onwards
- Designed for IoT and battery operated applications
- Bluetooth® LE versions are backward compatible
- 40 channels with 2 MHz bandwidth (2.402 – 2.480 GHz)
- Lower transmitting power
- Mainly short connections (to save battery lifetime)
- Different application roles and profiles: Broadcaster, Observer, Peripheral, Central

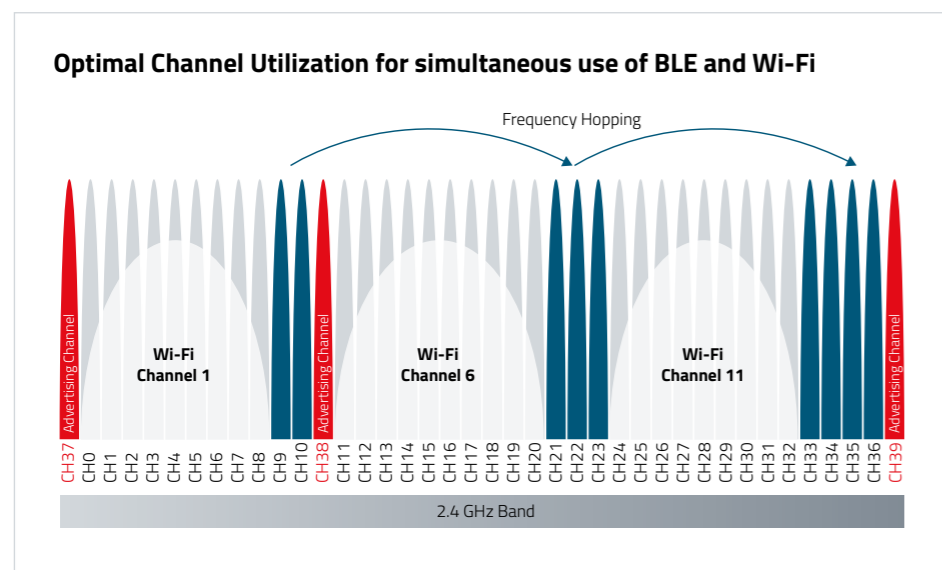
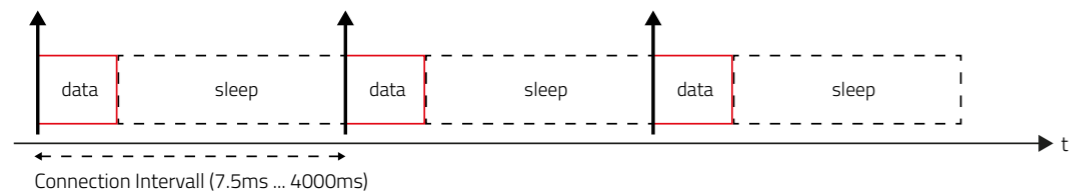

Bluetooth® Low Energy

- Generic Attribute Profile (GATT) is a generic "language" between Bluetooth® LE devices
- Custom GATT profiles: Amber SPP-like (Serial Port Profile) e.g. Bidirectional transmission of arbitrary data
- Predefined GATT profile:
 - Battery service profile, e.g. Shares value x in percentage 0% (discharged) - 100% (fully charged)
 - Notification service when status changes
 - Link loss service: e.g. Alerts after timeout, or link is lost or user alert

History of Bluetooth®

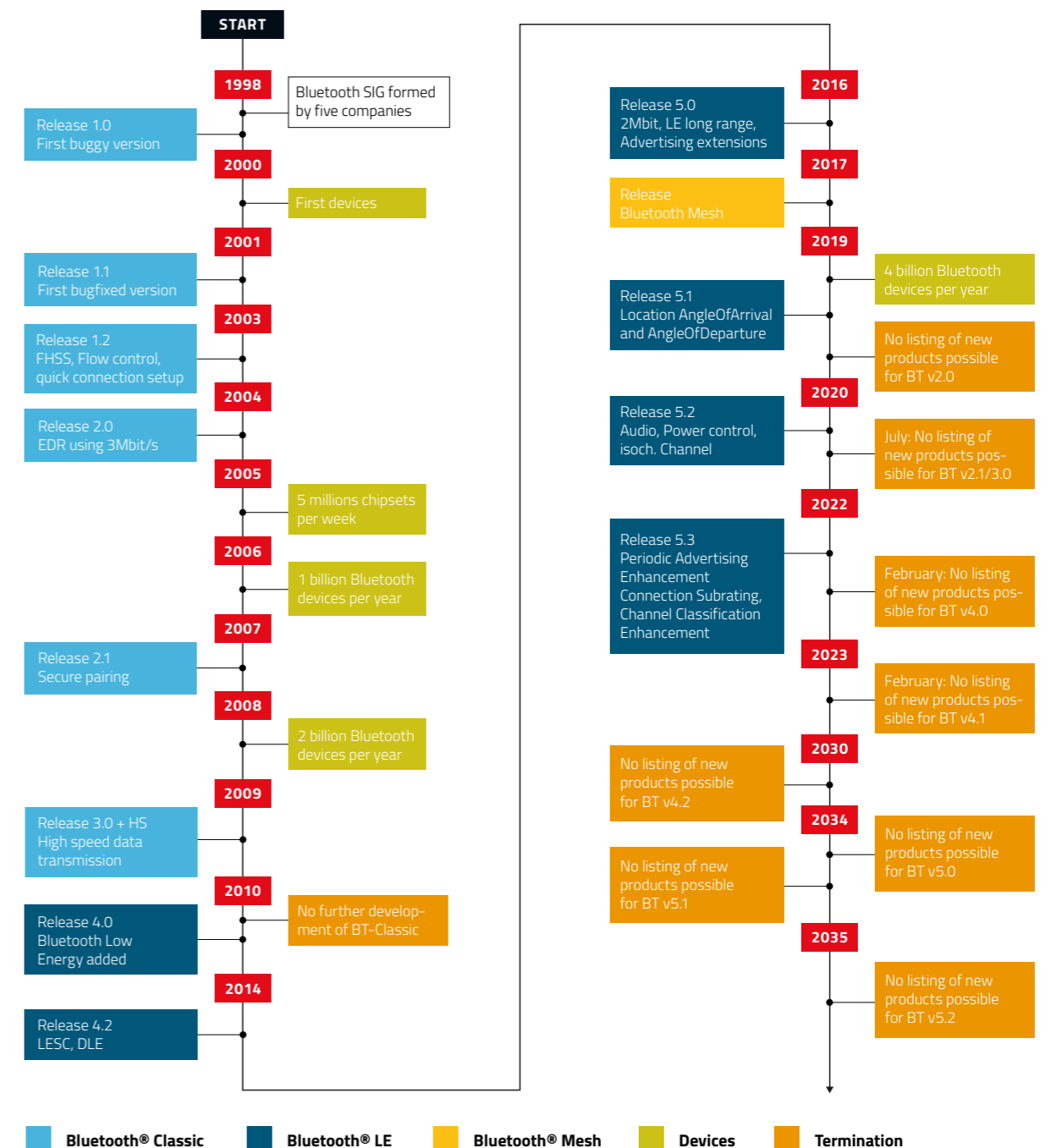

Withdrawal: Specifications withdrawn by the Bluetooth® SIG are not maintained and will no longer be available for download on the Bluetooth® public website. Members are not permitted to complete qualifications/declarations for any product using those withdrawn specifications.

BLUETOOTH® LOW ENERGY IN GENERAL

Bluetooth® LE roles – connection based

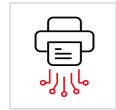

Peripheral

- Offers connections and services
- Defines the security level of its services and data
- Acts as slave
- Example:** Most applications, Door control, Service interface, Light, Roller Shutter, Heart rate monitor



Central

- Initiator for all connections with peripherals
- Always as master in a connection with a peripheral
- Example:** mobile phone at service interface, remote controller

Bluetooth® LE roles – connection less



Broadcaster

- Only transmits advertising events
- Example:** Sensor beacon



Obeserver

- Only receives advertising events
- Example:** Beacon receiver

Bluetooth® LE 4.0

- First version of Bluetooth® LE
- Low energy as protocol stack specified
- 31 Bytes per radio data packet (→ low throughput)
- Output power lower than 10 mW (10 dBm)

Bluetooth® LE 4.1

- Better coexistence with 4G radio
- Optimisation of Bluetooth® LE behaviour through configurability of parameters (time interval for reconnection)
- Central and peripheral functions in one device
- New profiles, like IPSP (Internet Protocol Support Profile) for IPv6

Bluetooth® LE 4.2

- (Optional) Data length extension (DLE) to support packets up to 255 Bytes (→ higher throughput)
- (Optional) Additional secure pairing modes (Low Energy Secure Connections - LESC)

Bluetooth® LE 5.0

- (Optional) Large advertising packets
- (Optional) New frequency hopping sequence for better coexistence
- (Optional) Increased maximum output power to 100 mW for higher range
- (Optional) 2 MBit/s phy data rate
- (Optional) Higher range due to LE Coded radio (Long Range mode)

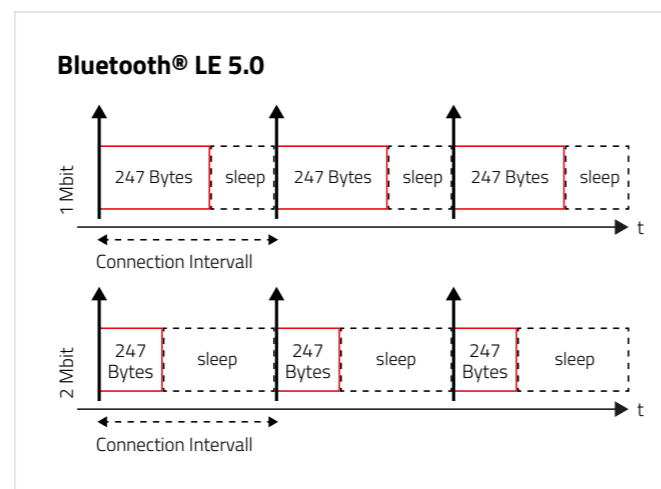

i All versions are downwards compatible.

Bluetooth® LE 5.1

- (Optional) Faster connection setup by GATT caching to save the discovery step
- (Optional) Advertising enhancements
- (Optional) Bluetooth® direction finding to detect the direction of a radio signal:
 - Angle of arrival (AoA) for item finding applications
 - Angle of departure (AoD) for indoor positioning applications

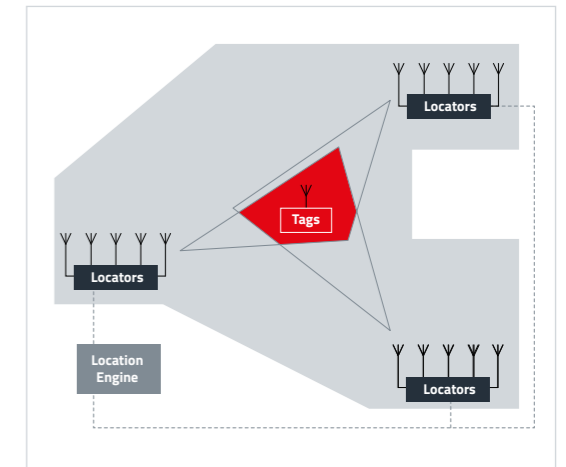

Bluetooth® LE 5.2

- (Optional) Enhanced Attribute Protocol Sharing radio sources of different profiles in one data packet
- (Optional) Adaptive power control to save power and reduce interference Monitor the RSSI and request the transmitter to reduce/increase its power
- (Optional) LE Isochronous Channels: allows the communication of time-bound data to one or more devices for time-synchronized processing discard data of radio packet after time to live (TTL)
- (Optional) New audio profiles (LE Audio)

Bluetooth® LE 5.2 Audio

- Multistream
 - Independent, synchronous streams
 - More robust and better stereo
- New applications
 - Connect hearing aid to PC, smart phone or TV
 - Broadcast audio sharing, e.g. for cinemas, theaters, airports,...
- Higher quality and less power consumption

	Original	LE Audio	Classic Audio
Codec	None	LC3 (Low Complexity Communication Codec)	SBC (Low Complexity Subband Codec)
Throughput	1.5Mbit/s	192kbit/s	345kbit/s
Energy consumption (radio)	Very High	Low	High
Audio quality	Very High	High	Medium

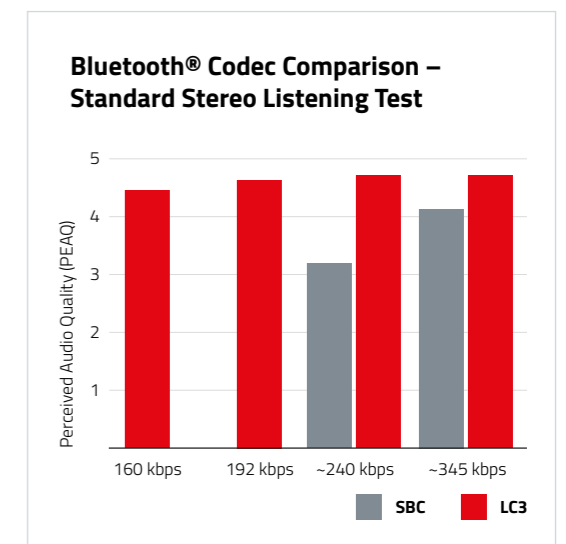

Bluetooth® LE 5.3

- (Optional) Periodic Advertising Enhancement
 - Twice detected advertising packets are dropped during reception to save current
- (Optional) Connection Subrating
 - In periods with low traffic a connection may be slowed down temporarily to save current
- (Optional) Channel Classification Enhancement
 - Now the peripheral can also provide a black list of noisy radio channels

BLUETOOTH® SPECIAL INTEREST GROUP (SIG)

Different Memberships

Promoter Members

Have considerable influence over both, the strategic and technological directions of Bluetooth® (Apple, Intel, IBM,...).

Associate Members

Get early access to draft specifications and are eligible to participate and gain a voting seat in working groups and committees. Furthermore, to work with other Associate and Promoter members on enhancing existing specifications.

Adopter Members

Use published Bluetooth® wireless specifications and Bluetooth trademarks.

Listing - Qualification and Declaration

- The Bluetooth® listing consists of qualification and declaration
- The qualification process is one of the most important aspects of **Bluetooth® technology, supporting interoperability** and conformity to the Bluetooth® specifications
- Bluetooth® Qualification Consultants (BQCs) are available to support members through the processes
- Qualification means the whole process including tests
- Members of the Bluetooth® SIG must complete the qualification and declaration process for their Bluetooth® enabled product to demonstrate and declare compliance
- The distributor is responsible to ensure that the required listing is performed
- A Listing is possible, if an already qualified product is used. Then there is no measuring or testing effort, only declaration and information work to be done
- BT Listing USD 9.600 per end device

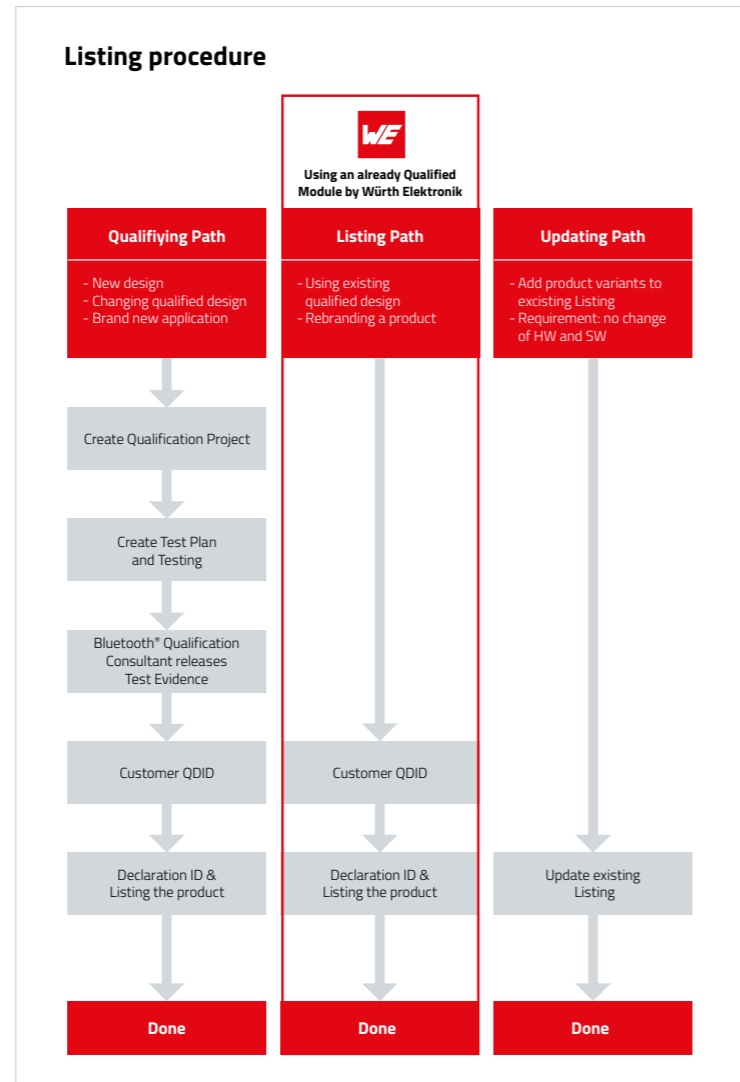

Reasons for Bluetooth® in Industry

- ✓ Smart and innovative
- ✓ Robust and open communication
- ✓ Use smart device as display
- ✓ Worldwide common standard

PRODUCT OVERVIEW

	Proteus-e	Proteus-I	Proteus-II	Proteus-III
Order Code (PCB Antenna)	2612011024000*	2608011024000	2608011024010	2611011024000*
Order Code (RF-Pad)		2608011124000	2608011124010	
Chipset	nRF52805	nRF52832		nRF52840
Bluetooth® Standard	5.1	4.2	5.0	5.1
Output Power [dBm]		4		8
Power Consumption Rx [mA]	6.8	5.4		7.7
Power Consumption Tx [mA]	9.3	7.5		18.9
Power Consumption Sleep [µA]	0.3	0.4		0.4
Supply Voltage min - max [V]		1.8 - 3.6		
op. Temp [°C]		-40 ... +85		
Max Datarate [Mbps]	2	1	2	2
Payload [byte]	243	243	964	964
measured Throughput [kbps]	100	80	257	343
Antenna (PCB, RF-Pad, SAS*)	SAS*	PCB / RF-Pad		SAS*
Long range Mode		-		✓
LoS Range (Int / ext. Antenna) [m]	30 / 350	50 / 100		100 / 400
LoS Test Conditions	2 m height, Two-ray ground-reflection, TX and RX antenna gain = 0 dB			
Interface	UART			
SPP-like Profile	✓	✓	✓	✓
USB-Radio Stick	-	-	✓	✓
FOTA	-	✓	✓	✓
Additional GPIO	2	-	-	6
Certification	CE, FCC, IC, TELEC			



Setebos-I Radio Module 2.4 GHz with Proprietary and Bluetooth® LE 5.1 Radio Protocol

page: 85

Proteus Connect

The most important benefit of Bluetooth® LE Connections is mostly a mobile app. With the Proteus-App we provide you a fast and easy way of testing and also a base for your own app.

- Smart-Device Mobile App for easy testing for Android and iOS
- Scan – Connect – Transmit Commands directly
- Development files available on GitHub
- Build your own App on base of Proteus-App

we-online.com/Proteus-App



GET IT ON
Google Play



Download on the
App Store

GitHub



OUR SLIM-VERSION: BLUETOOTH® LOW ENERGY 5.1

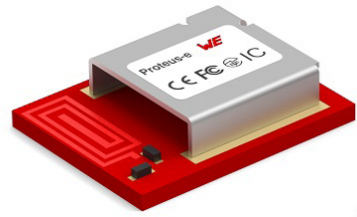

Proteus-e
Bluetooth® Low Energy 5.1 Standard

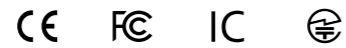

Characteristics



- Bluetooth® 5.1 qualified end product
- Miniaturized design - 7 x 9 x 2 mm
- 64 MHz Arm® Cortex®-M4 processor
- Nordic Semiconductor SoC nRF52805
- 192 kB flash memory, 24 kB RAM
- Up to 4 dBm output power
- 1 Mbit and 2 Mbit radio
- Payload size of up to 243 bytes
- Command –based and transparent UART interface
- Serial data transmission (Smart Serial Profile)
- Peripheral function
- Free definition of advertising packets
- 2 pins for remote GPIO access
- Smart antenna selection (2-in-1 Module)
- CE, FCC, IC, TELEC certification

we-online.com/Proteus-e

OUR FASTEST: BLUETOOTH® LOW ENERGY 5.1



Proteus-III / Proteus-III SPI
Bluetooth® Low Energy 5.1 Standard with
2 MBit PHY and Coded PHY (long range)

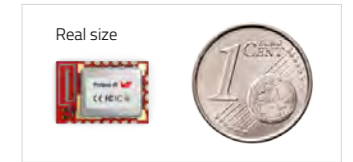

Characteristics

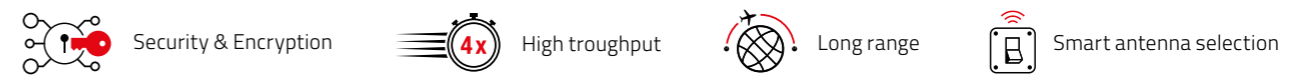

- Bluetooth® 5.1 qualified end product
- Nano SIM size - 8 x 12 x 2 mm
- ARM® Cortex®-M4 32-bit processor with FPU, 64 MHz
- Nordic Semiconductor SoC nRF52840
- 1 MB flash memory, 256 kB RAM
- Up to 8 dBm output power for higher range
- 1 Mbit and 2 Mbit radio and long range modes
- High throughput mode, 4 times higher throughput with payload size of up to 964 bytes
- Scan and Connect in long range mode
- Improved throughput with transparent UART interface (Peripheral only mode)
- Serial data transmission (Smart Serial Profile)
- LE Secure Connections (LESC)
- Connect (1:n / n:1) as central or peripheral
- 6 configurable digital GPIOs (local & remote)
- Smart antenna selection (2-in-1 Module)
- Also available as proprietary radio module (Thyone-I)
- CE, FCC, IC, TELEC certification

we-online.com/Proteus-III



Webinar:
Bluetooth® LE - new adaptations



BLUETOOTH® CLASSIC



Puck-I
Bluetooth® Classic Radio Module

CE FC IC



Characteristics

Bluetooth Classic Audio
 Small form factor
 Bluetooth® SPP Profiles

- Embedded Bluetooth® 2.0 RF module (Class 2)
- Former: BlueNicecom4 (AMB2301)
- Digital AUDIO interface (PCM interface)
- Integrated profiles: SPP, GAP, SDAP
- Supported profiles: DUN, FAX, FTP, HSP, HFP, OPP, SYNC, BIP, BPP
- Small form factor
- Integrated PCB antenna
- UART interface with programmable baud rate
- Quick-Start Evaluation Kit available
- EN 300 328 compliant

IMPORTANT NOTE

As it is not possible to add or change a listing based on the withdrawn Bluetooth® Specification 2.0 this module is not recommended for new designs.

- It is the customers responsibility to list its products with BT SIG
- Würth Elektronik still sells the products to customers, even long term

History of Bluetooth® Classic

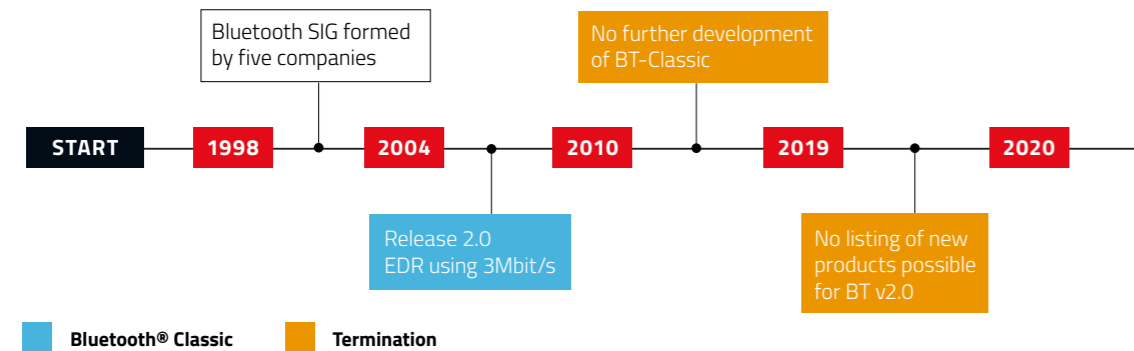

we-online.com/Puck-I



THE FUTURE IS WIRELESS

ADDED VALUES

Development Tools

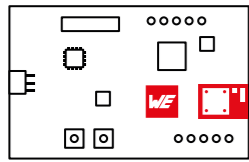

Eval Boards

- Easy testing
- Rapid prototyping
- FTDI integrated (UART to USB)
- Pins available on header
- Current measurement



we-online.com/EVAL-BLE



More information on page 150

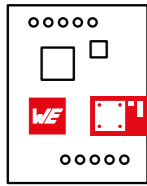

Mini Eval Boards

- Application-oriented, cost-effective and compact size
- USB connection with FTDI-cable possible (available as accessory)



we-online.com/EVAL-BLE



More information on page 150



USB-Radio Stick

- USB-FTDI-Proteus-III
- Bluetooth®-Listing included



we-online.com/USB-BLE



More information on page 150



Smart Commander

- PC-Tool for easy testing
- AT-Commands as buttons
- Monitoring UART-Communication
- Export Commands for easy integration in the former HOST-Controller
- Test Bluetooth®-App-Connectivity easily



we-online.com/SmartCommander

AppNotes



Proteus: Low Power Application With Periodic Wake-Up

we-online.com/ANR003



Proteus: How To Use The Peripheral Only Mode

we-online.com/ANR004



Proteus: High Throughput Mode

we-online.com/ANR006



Proteus Quickstart: Connect a smart phone to a Proteus

we-online.com/ANR014



Proteus-III: Advanced Developer Guide

we-online.com/ANR009



Proteus-III: Remote GPIO control – How To

we-online.com/ANR020



Proteus-E Advanced Developer Guide

we-online.com/ANR024



Proteus-E Quickstart

we-online.com/ANR025



Bluetooth® Listing Guide

we-online.com/ANR027



nRF Connect

we-online.com/ANR030

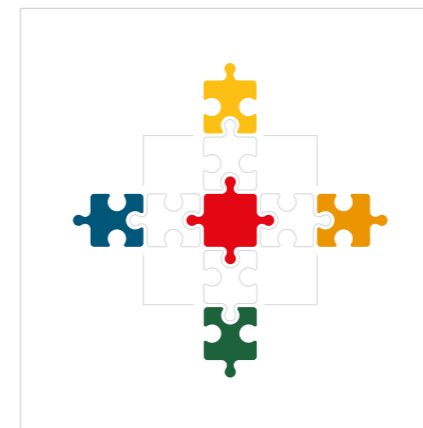

Software Development Kit

- Typically as C-Files, for mobile Apps platform specific languages
- For comfortable coding of:
 - The HOST-controller system
 - PC Applications & Mobile Apps
- Code examples in Application notes and Manuals



we-online.com/WCO-SDK

WI-FI



INTRODUCTION	61
PRODUCT OVERVIEW	63
ADDED VALUES	66

INTRODUCTION

Wi-Fi - an Overview

Wireless LAN - Wi-Fi

Wi-Fi (wireless fidelity) is a specification for ensuring interoperability, based on the IEEE 802.11 family of standards, which are commonly used for local area networking of devices and Internet access. Wi-Fi is a trademark of the non-profit Wi-Fi Alliance, which restricts the use of the term Wi-Fi Certified to products that successfully complete interoperability certification testing.



- Wi-Fi 1**
- 1999
 - IEEE 802.11 b
 - 2.4 GHz
 - 11 Mb/s

- Wi-Fi 2**
- 1999
 - IEEE 802.11 a
 - 5 GHz
 - 54 Mb/s

- Wi-Fi 3**
- 2003
 - IEEE 802.11 g
 - 2.4 GHz
 - 54 Mb/s

- Wi-Fi 4**
- 2009
 - IEEE 802.11 n
 - 2.4 / 5 GHz
 - 150 Mb/s

- Wi-Fi 5**
- 2013
 - IEEE 802.11 ac
 - 5 GHz
 - 3.5 Gb/s

- Wi-Fi 6**
- 2018
 - IEEE 802.11 ax
 - 2.4 / 5 GHz
 - 9.6 Gb/s
 - WPA 3 Security

Versions – old and new Notations (view also Table besides)

The different versions of Wi-Fi are specified by various IEEE 802.11 protocol standards, with the different radio technologies determining radio bands, and the maximum ranges, and speeds that may be achieved. Wi-Fi most commonly uses the 2.4 gigahertz and 5 gigahertz radio bands; these bands are subdivided into multiple channels (see figures below). Channels can be shared between networks but only one transmitter can locally transmit on a channel at any moment in time. As Wi-Fi implements CSMA/CA/listen before talk propability of collisions on the same channel can be minimized, but they cannot be reduced to $p = 0$.

2.4 GHz Channels

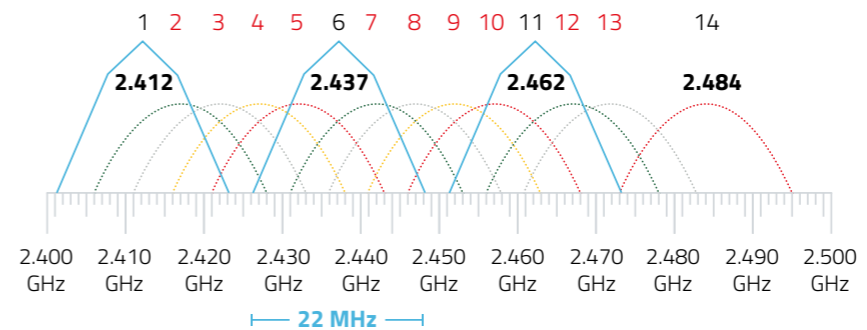

5 GHz Channels

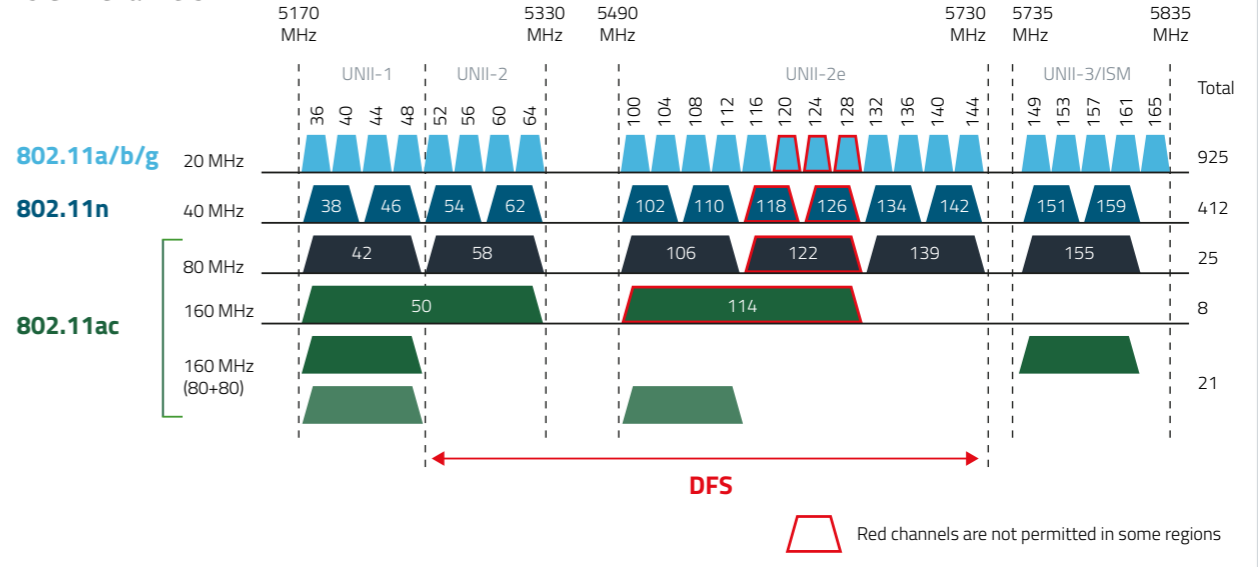

Cellular

Bluetooth®

Wi-Fi

Proprietary

Combined

Mesh

Wireless M-Bus

Build Your Own Firmware

GNSS

Sensors

INTRODUCTION

Range and Power

Wi-Fi's wavebands have relatively high absorption and work best for line-of-sight use. Many common obstructions such as walls, pillars, home appliances, etc. may greatly reduce range, but this also helps minimize interference between different networks in crowded environments. An access point (or hotspot) often has a range of about 20 metres indoors while some modern access points claim up to a 150-metre range outdoors. Over time the speed and spectral efficiency of Wi-Fi have increased. As of today: (802.11ax -> up to 11 Gbit/s), at close range, some versions of Wi-Fi, running on suitable hardware, can achieve speeds of over 1 Gbit/s (gigabit per second).

Connection

There are two modes in which Wi-Fi networks can operate. In the infrastructure mode, an access point acts as a central entity serving several connected clients. To connect to such a Wi-Fi network, a user typically needs the network name (the SSID) and a password. The password is used to encrypt Wi-Fi packets to block eavesdroppers. The most common security method is Wi-Fi Protected Access (WPA) which is intended to protect information moving across Wi-Fi networks and includes versions for personal and enterprise networks.

The Wi-Fi direct mode offers a point-to-point connection without the need for a dedicated central entity. The trick with Wi-Fi direct is – one of the two will be the central one on the peripheral entity (autonegotiated) so there is a central entity!

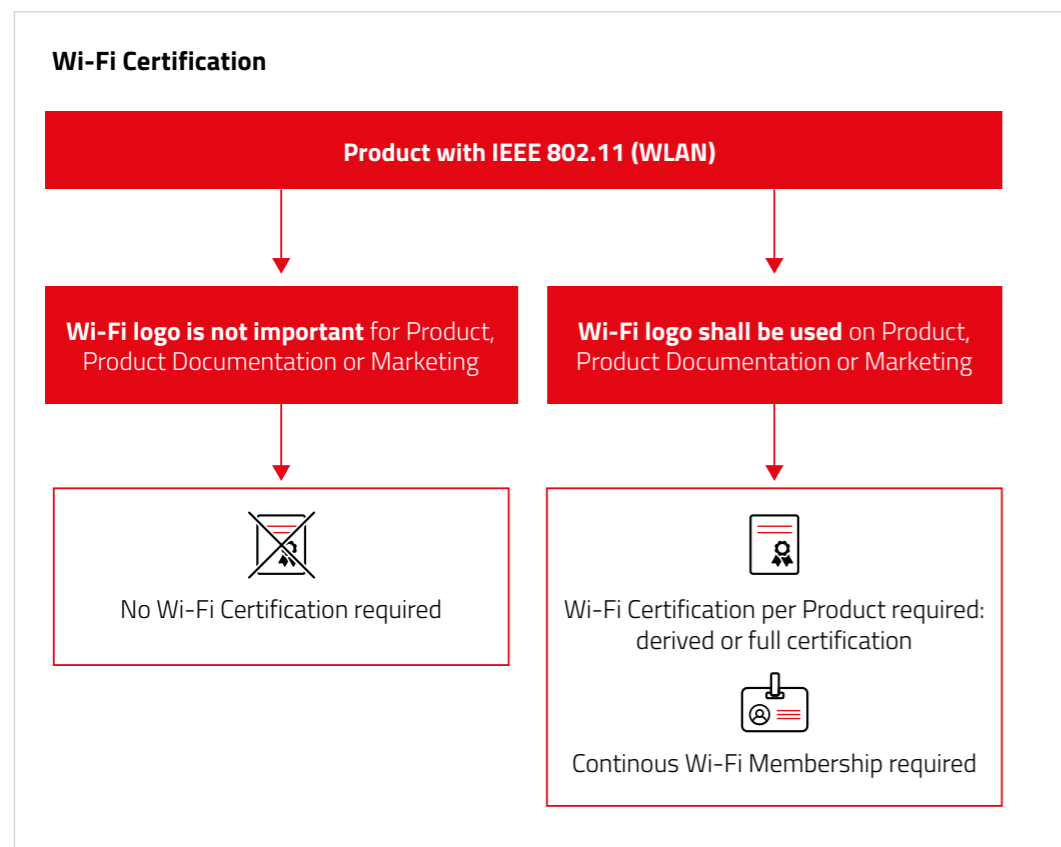

OUR NETWORKER: WI-FI 2.4 GHz



Calypso

Fully featured standalone Wi-Fi module
IEEE 802.11 b/g/n, 2.4 GHz



Characteristics



Security and encryption



Global availability 2.4 GHz licence free band



Smart antenna selection

- Wi-Fi module based on TI - CC3220SF wireless MCU
- Standalone Wi-Fi operation
- IEEE 802.11 b/g/n, 2.4 GHz
- Small form factor: 19 x 27,5 x 4 mm
- Industrial temperature range: -40 °C up to +85 °C
- Low power operation to support battery operated applications
- Sleep mode <10 µA, Power save mode < 2mA (Active network connection)
- Output power +18 dBm peak (1DSSS)
- Sensitivity -92 dBm (1DSSS, 8% PER)
- Smart antenna configuration (2-in-1 Module)
- Protocols implemented: TCP/IP(IPv4/IPv6), MQTT, SNTP, mDNS, DHCP
- UART-to-Wi-Fi bridge (Transparent mode)
- RESTful API support
- WPA3 Wi-Fi security support
- Remote GPIO configuration and control

Product video

Calypso Wi-Fi Radio Module for Industrial Applications

bit.ly/WE_Calypso

FEATURES

1. SECURITY FEATURES

Secure Boot

- Würth Elektronik eiSos certificate stored in FLASH as standard
- Boot loader checks firmware before launching it
- Ensure it's signed by Würth Elektronik eiSos
- Prevents malware from hijacking your boot process

Security

- Good basis for secure end application:
 - Wi-Fi security – WPA3
 - Secure boot
 - Secure storage
 - Secure socket
 - Hardware accelerated crypto engine
 - Software tamper detection
- Nevertheless and finally, the user determines end product security

Secure Storage for User Data

- Encrypted file system on FLASH
- Created on first boot-up
- Failsafe
- AT-commands to operate the file system
- Secure storage of SSL/TLS certificates, other keys and secrets
- Homepage access to upload files

2. FUNCTIONAL FEATURES

Low Power Operation

- Power-optimized out of the box: the included firmware makes sure, that all functions are optimized to low power consumption
- Sleep and low power modes
- Wake up:
 - Timer
 - Wake up pin
- Sleep current of only 5.5 µA
- Fast connect: from SLEEP to CONNECTED in ~350 ms

Smart Antenna Selection

Calypso's smart antenna configuration enables the user to choose between two antenna options:

On board PCB Antenna

The Calypso has an on-board PCB antenna optimized for operation in the 2.4 GHz band. A simple short between the pins RF and ANT feeds the RF output of the module to the onboard antenna. In this configuration, the module does not require any additional RF circuitry

External Antenna

For applications that use an external antenna, the Calypso provides a 50Ω RF signal on pin RF of the module. In this configuration, pin ANT of the module has to be connected to ground and pin RF to the external antenna via 50Ω feed line.

Provisioning

- Bring the device into an existing Wi-Fi network
- In field device configuration
- Access Point mode
- Host triggered (pin/command from host)
- Web-interface – Platform independent

Firmware Over The Air Update (FOTA)

- Update of firmware over the wireless network
- Pin triggered: physical access security
- Signed images: malware cannot be uploaded
- Failsafe: module can always be put into factory settings

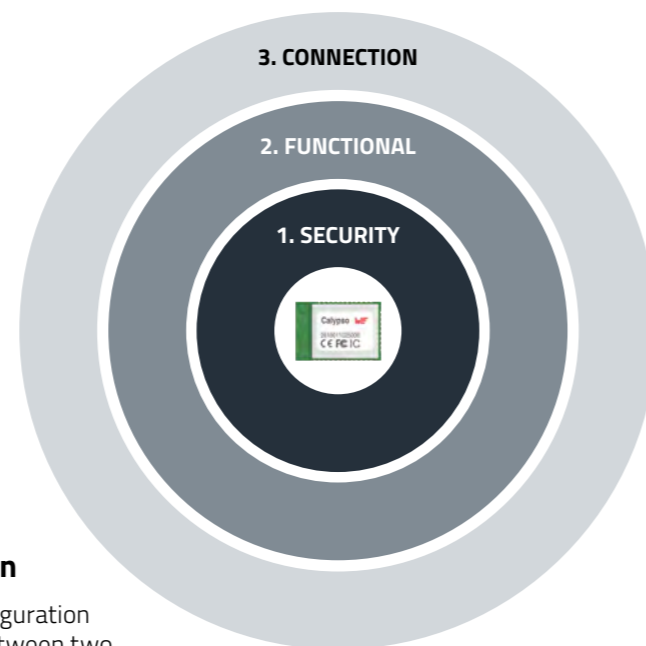

3. CONNECTION FEATURES

Hypertext Transfer Protocol (HTTP)

The Hypertext Transfer Protocol (HTTP) is an application layer protocol for distributed, collaborative, hyper- media information systems. It works based on a client-server mechanism where the server responds to requests from the client. HTTP running on top of a secure transport (SSL/TLS) is referred to as HTTPS.

- HTTPS server on module for provisioning and OTA
- **Customer specific webpages possible:**
 - Limited storage for http server onboard
 - Easy to change the existing page by replacing logo, device name and company name in the provided file
- HTTPS client implementation over AT commands
- All standard request methods supported (Get, Put, Post, Delete)
- Root Certificate Authorities (CA) catalog for HTTPS onboard

Multicast DNS

The mDNS protocol resolves hostnames to IP addresses in small networks that do not have a central name server. mDNS clients that needs to resolve a hostname send IP multicast query messages that asks for hosts having that name. The host then multicasts the IP address. Calypso supports mDNS and advertises the webpage by default.

Transport Layer Security (TLS) vs. Secure Sockets Layer (SSL)

Transport Layer Security (TLS), and its now-deprecated predecessor Secure Sockets Layer (SSL) are cryptographic protocols designed to provide communications security over a computer network. The TLS protocol aims primarily to provide privacy and data integrity between two or more communicating computer applications. When secured by TLS the connection has the following properties:

- The connection is private (encrypted by unique session key)
- The identity of both the communicating parties have been authenticated
- The message integrity guaranteed

Calypso supports SSL and TLS1.2

MQTT on Module

Calypso offers AT commands to create an MQTT client, subscribe to topics and publish topics.

- MQTT – Message Queuing Telemetry Transport
- Lightweight application layer protocol
- For connections with remote locations (typically M2M) where:
 - A „small code footprint“ is required or
 - The network bandwidth is limited
- Calypso implements MQTT client:
 - Offers Publish/Subscribe mechanism
 - Runs on top of TCP/TLS
- Suitable for low-power, low-bandwidth applications
- Used extensively in M2M, IoT applications

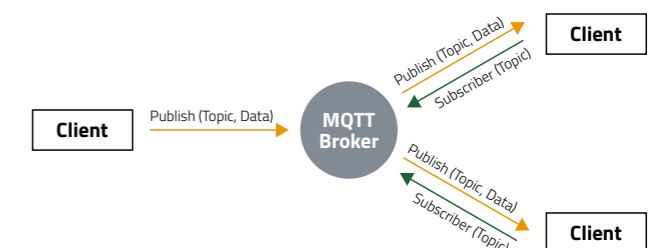

Calypso Wi-Fi Direct (P2P)

- Peer-to-Peer without infrastructure
- Group-owner or client roles
- Auto device discovery
- Not battery optimized

ADDED VALUES

Development Tools

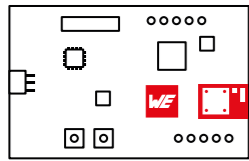

Eval Boards

- Easy testing
- Rapid prototyping
- FTDI integrated (UART to USB)
- Pins available on header
- Current measurement
- Nano sim card holder



we-online.com/EVAL-WiFi



More information on page 150



FeatherWing

- Adafruit standard
- Easy connectable
- For complex system tests



More information on page 152



AT Commander

- Complete control of module over UART
- ASCII based "Human readable" commands
- Intuitive request/response/event mechanism
- PC tool for quick prototyping "AT Commander Tool"



we-online.com/AT-Commander

AppNotes

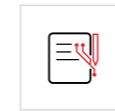

Calypso IoT Application Based On Calypso Module

we-online.com/ANR007

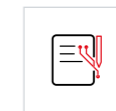

Calypso Cloud Connectivity

we-online.com/ANR023

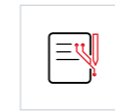

UART-to-Wi-Fi bridge using Calypso

we-online.com/ANR028



Calypso Remote GPIO

we-online.com/ANR029

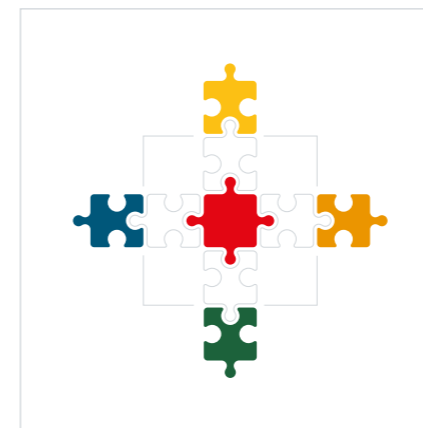

Software Development Kit

- Typically as C-Files, for mobile Apps platform specific languages
- For comfortable coding of:
 - The HOST-controller system
 - PC Applications & Mobile Apps
- Code examples in Application notes and Manuals



we-online.com/WCO-SDK

PROPRIETARY

INDUSTRY PROVEN & LICENSE FREE



INTRODUCTION 69

PRODUCT OVERVIEW 76

ADDED VALUES 82

INTRODUCTION

Proprietary Radio Stack

All Wireless Connectivity RF Modules have the WE-ProWare pre-loaded

Our module added value is the WE-ProWare operating system which is fully included. Communication functions are configured with simple AT commands. You can easily swap between radio channels and protocols. All this makes it very easy to enter new markets with your application.

 More information on page 74

Proprietary Radio as Bluetooth® LE Alternative

- Connection only with authorized devices by the manufacturer
- Security aspect as argument for the endcustomers
- Closed communication is „invisible“ for Smart devices
- Higher throughput possible – no effort with big overhead of Bluetooth®
- Saving Bluetooth® Listing costs
- Business model to build the whole chain as user experience
- Binding the end customer to the product with additional accessory with the same communication



THE IDEA to connect wireless to a device:

- Parameterization for commissioning
- Start/stop measurement
- Read out results
- Notification danger
- Connecting for service
- Checking device state for predictive maintenance
- Recalibration

NO STANDARD radio protocol does fit

- Tried to implement Bluetooth® a few years ago:
 - Bluetooth® classic with too high energy consumption
 - Bluetooth® Listing Costs too high
 - Small quantities cannot carry the high costs
 - Bluetooth® LE not flexible enough for the idea
- Same is valid for Sub-GHz LoRa, SigFox, etc.



THE SOLUTION

Proprietary Communication as solution:

- Easy adaption possible
- Fitting perfectly to the needs
- No license costs arise
- Full control over application

Cellular

Bluetooth®

Wi-Fi

Proprietary

Combined

Mesh

Wireless
M-Bus

Build Your
Own Firmware

GNSS

Sensors

INTRODUCTION

Radio Frequency Spectrum

The radio frequency spectrum is regulated by designated regulatory authorities that define how specific spectrum bands can be used. The ISM (Industrial, Scientific and Medical) and SRD (Short Range Device) bands are free to use without license costs. As there is no single worldwide regulation, national authorities define which of the frequency bands are open for access in each specific country.



Furthermore in ISM bands regulation there is no directive about a specific radio protocol. That means, it doesn't matter if a proprietary radio protocol or standard radio protocols will be chosen. Everybody can use individual firmware within the regulations of the frequency bands (output power, duty cycle, ...). The correlation between data rate, range and battery life could be arranged individually.

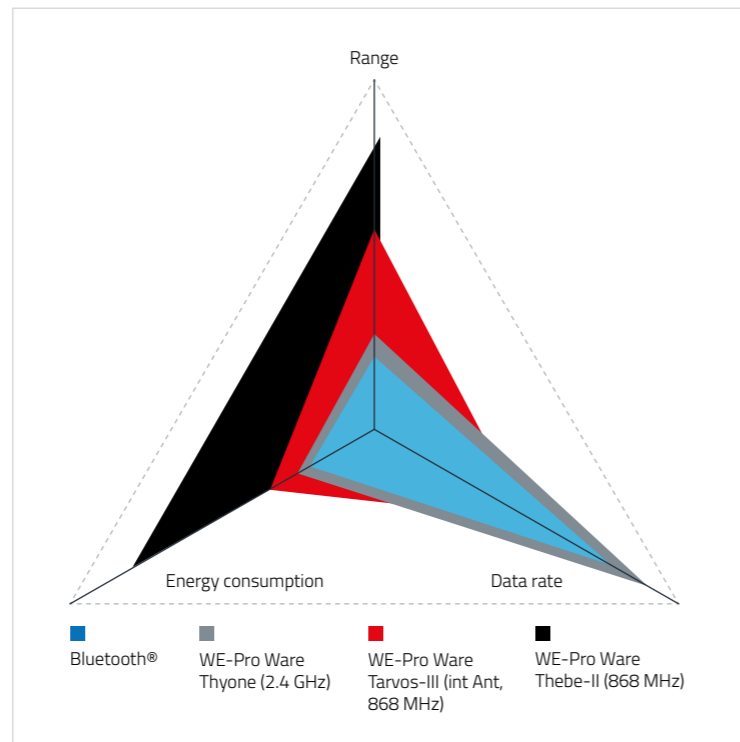

Advantages

- ✓ Security due to closed system
- ✓ More flexibility compared to standard
- ✓ More scope for design
- ✓ No dependences
- ✓ No umbrella organization
- ✓ No license fees

Areas of Application

 Machine to Machine	 (Home) Automation	 Wireless Sensor Networks
 Internet of Things (IoT)	 Monitoring / Control	 Medical
... and many others		

NETWORK TOPOLOGIES



Point to point

Point to point topology is the type of network topology which is used to connect to network nodes directly with each other through some link. In between these two nodes, the data is transmitted using this link.

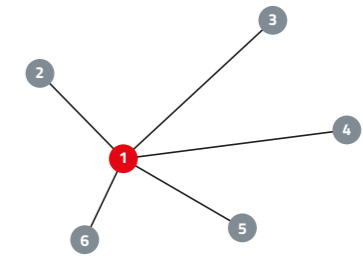

Star

In a star topology all nodes are connected via a central station. All communication is only possible via the central node

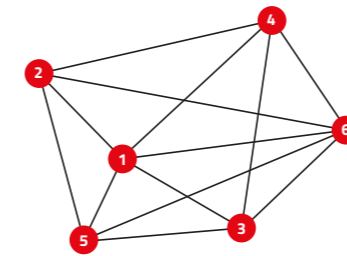

Peer to Peer

In peer to peer topology every node has a direct connection to the other nodes and can communicate to each other.

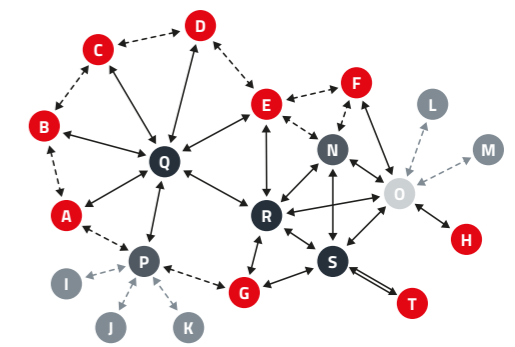

Flooding Mesh

In a flooding mesh topology an indirect communication between nodes is possible. The message will be repeated until it reaches the receiver.

SHORT RANGE DEVICE FREQUENCY BANDS

Short Range Device (SRD)

A short-range device (SRD) is a radio-frequency transmitter device used in telecommunication for the transmission of information, which has low capability of causing harmful interference to other radio equipment.

Short-range devices are low-power transmitters typically limited up to 500 mW effective radiated power (ERP) or less, depending on the frequency band, which limits their useful range to few hundred meters, and do not require a license from its user.

Frequency [MHz]	Band	TX Power [dBm]	TX Power [mW]	Duty cycle	max. occupied BW*	Notes
169.400 - 169.475	D	+ 27	500	≤ 1 %	50	For metering devices: 10 % DC;
169.400 - 169.4875	E	+ 10	10	≤ 0.1 %	whole band	
169.4875 - 169.5875	F	+ 10	10	≤ 0,001 %	whole band	0,1 % DC during 0:00 and 6:00 local time; Equipment that concentrates or multiplexes individual equipment is excluded.
169.5875 - 169.8125	G	+ 10	10	≤ 0,1 %	whole band	
433.050 - 434.790	H	+ 10	10	10 %	whole band	
433.050 - 434.790	I	0	1	no limits	whole band	-13 dBm / 10kHz PSD when bw > 250 kHz, audio/video applications are excluded
433.050 - 434.790	J	+ 10	10	no limits	25	audio/video applications are excluded
863.0 - 865.0	K	+ 14	25	≤ 0.1 % or psa**	whole band	OBW restrictions except audio & video limited to 300 kHz
865.0 - 868.0	L	+ 14	25	≤ 1 % or psa**	whole band	
868.0 - 868.6	M	+ 14	25	≤ 1 % or psa**	whole band	
868.7 - 869.2	N	+ 14	25	≤ 0.1 % or psa**	whole band	
869.4 - 869.65	P	+ 27	500	≤ 10 % or psa**	whole band	
869.7 - 870.0	Q	+ 7	5		whole band	audio / video applications are excluded
869.7 - 870.0	R	+ 14	25	≤ 1 % or psa**	whole band	analogue audio / video are excluded
2400.0 - 2483.5		+ 10	10	no limits	whole band	non specific short range devices
2400.0 - 2483.5		+ 14	25	no limits	whole band	radio determination devices (radar, rfid,...)
2446.0 - 2454.0			500 / 4000		whole band	RFID only

* BW = Band width

**psa = Polite Spectrum Access

- ✓ License free bands
- ✓ Different frequency bands with different regulations
- ✓ Which band fits best your application
- ✓ Limitations in max TX power, Duty cycle and channel spacing

Source: EN 300 220 and EN 300 440

FIRMWARE: WE-PROWARE AS OPERATING SYSTEM

EXAMPLE: BLE Module

Fully featured & "BLE qualified" software stack

SPP-like profile (TX & RX characteristic) DIS, Security Modes, Bonding, FOTA, Automatic BLE Role switch, Low Power Optimization

EXAMPLE: Proprietary Module

Fixed hardware design "RF module"
→ Small formfactor
→ Robust RF modules

Individualization of parameters to match customer applications
e.g. configuration of
→ UART baudrate
→ RF output power

WE-PROWARE

PROPRIETARY RADIO STACK

INTRODUCTION & EXPLANATION



WE-ProWare is an Operating System to manage the Würth Elektronik radio modules.

WE-ProWare is a software product marketed under the Würth Elektronik brand and protected by Würth Elektronik.

WE-ProWare is a manufacturer specific, non-public and not free available radio protocol. Following it is no open source software. The software's binary image and sourcecode will not be published.

WE-ProWare is a firmware for Würth Elektronik radio modules which combines user configurable radio parameters, coding, channel access and a communication protocol which are referred to as proprietary. Thus, it does not comply with generally accepted communication standards, i.e. Bluetooth, Wi-Fi, Ethernet or else.

WE-ProWare is owned by and protected by copyright of Würth Elektronik.

WE-ProWare is restricted by license law through manufacturer-specific know-how and/or through patents.

WE-ProWare is a manufacturer-specific wireless transmission technology. It defines the technical aspects on how to transmit and receive data wirelessly between Würth Elektronik radio modules. Proprietary systems are closed systems that enable communication between each other. Following, the software code of WE-ProWare is specifically designed for Würth Elektronik hardware and is neither compatible nor interoperable with hardware from other manufacturers.

The WE-ProWare Radio Stack is an Industry Proven Robust Wireless Connection

With more than 20 years of experience, Würth Elektronik eiSos offers a radio stack ready to run, build and connect out of the box – called WE-ProWare. This radio stack is an easy-to-use and effective networking protocol. Without a radio stack an RF module is pure hardware. Even when Software Development Kits (SDKs) are offered, you have to spend months, sometimes years, to get your module up and running.

Extensive Features

The WE-ProWare offers you the option to connect external peripherals using numerous interfaces, such as UART or digital and analog I/O. In TRANSPARENT MODE the WE-ProWare radio stack can carry any kind of application data, simple conversion of UART to radio and vice versa. In COMMAND MODE you have full control of all features. The UART interface is used for serial communication as well as for configuration.

It is Pre-loaded on all Wireless Connectivity RF Modules

Our module added value is the WE-ProWare radio stack which is fully included. Communication functions are configured with simple AT commands. You can easily swap between radio channels and protocols. All this makes it very easy to enter new markets with your application.

The WE-ProWare Radio Stack Supports Different Network Topologies, incl.

- ✓ Point to Point
- ✓ Point to Multipoint
- ✓ Peer to Peer
- ✓ Mesh
- ✓ Multi-hop

MORE THAN A RADIO STACK - IT IS AN OPERATING SYSTEM

NO LICENSE FEES

The license fees applicable to be able to run WE-ProWare on Würth Elektronik radio modules is always included in the hardware price, unless otherwise specified. A key difference to generally accepted standards, i.e. Bluetooth, Wi-Fi or else is that, there are no annual membership fees, one-time costs for the device listing or recurring monthly subscription costs.

AREA OF APPLICATION

As an area of application, WE-ProWare as a proprietary radio system is always suitable if the transmitters exchange data with each other and no standardized interface to a public network through mobile phone, tablet and/or notebook is required.

WIRELESS APPLICATIONS

In conclusion, WE-ProWare does perfectly fit in wireless applications when the design of the end devices (e.g. automation machine, control cabinet) and/or the remote control(s) are under full control of the system designer. Using WE-ProWare in this case will save (recurring) license fees and offers a higher degree of flexibility in terms of data throughput, maximum transmission range and energy consumption.

Cellular

Bluetooth®

Wi-Fi

Proprietary

Combined

Mesh













Wireless M-Bus

Build Your Own Firmware

GNSS

Sensors

PRODUCT OVERVIEW

	Module	Order Code	Freq. / MHz	Output Power	LoS Range	LoS Test Conditions Antenna height/Datarate	Antenna	Datarate PHY/ RF-Profiles	RF-Channels	RF-Architecture	Power Consumption Rx	Power Consumption Tx	Power Consumption Sleep	Supply Voltage min-max	Communication Modes	Dimensions	Foot-print	Chip-set	Certification	EVAL-Kit	USB-Radio Stick
Titanium		260701111000	169 MHz	15 dBm / 31.6 mW	3 km	2 m / 1.2 kbps	RF-Pad	1.2 kbps (0) 2.4 kbps (1) 9.6 kbps (2) 25 kbps (4)	5	P2P, star	28 mA	59 mA	10 µA	2 - 3.6 VDC	transparent, command	17 x 27 x 3.8 mm	WE-FP-1	MSP430 + TI-CC1120	CE	✓	✓
		2605031141000	433 MHz	10 dBm / 10 mW	1 km	2 m / 4.8 kbps	RF-Pad	4.8 kbps (0)	21	P2P, star	24 mA	38 mA	0.3 µA	2.2 - 3.6 VDC	transparent, command	17 x 27 x 3.6 mm	WE-FP-1	MSP430 + TI-CC1101	CE	✓	
		2605041181000	868 MHz	11 dBm / 12.5 mW	1 km	2 m / 4.8 kbps	RF-Pad	4.8 kbps (0)	11	P2P, star	24 mA	38 mA	0.3 µA	2.2 - 3.6 VDC	transparent, command	17 x 27 x 3.8 mm	WE-FP-1	MSP430 + TI-CC1101	CE	✓	✓
		2607021181000	868 MHz	14 dBm / 25 mW	2 km	2 m / 2.4 kbps	RF-Pad	34.4 kbps (0) 2.40 kbps (1) 100 kbps (2)	41	P2P, star, mesh	30 mA	53 mA	3 µA	2 - 3.6 VDC	transparent, command	17 x 27 x 3.8 mm	WE-FP-1	MSP430 + TI-CC1125	CE	✓	✓
Highlight: Tavros-III		2609011081000	868 MHz	14 dBm / 25 mW	300 m	2 m / 0.625 kbps	PCB	38.4 kbps (0) 100 kbps (2) 0.625 kbps (3) 2.50 kbps (4) 400 kbps (5)	41	P2P, star, mesh	8 mA	26 mA	0.2 µA	2.2 - 3.8 VDC	transparent, command	17 x 27 x 3.8 mm	WE-FP-1+	TI-CC1310	CE	✓	
		2609011181000			10 km	6 m / 0.625 kbps	RF-Pad													✓	✓
Highlight: Thebe-I		2609031181000	868 MHz	27 dBm / 500 mW	20 km	6 m / 0.625 kbps	RF-Pad	38.4 kbps (0) 100 kbps (2) 0.625 kbps (3) 2.50 kbps (4)	4	P2P, star, mesh	12 mA	500 mA	0.9 µA	2.2 - 3.7 VDC	transparent, command	17 x 27 x 3.8 mm	WE-FP-1+	TI-CC1310	CE	✓	
Telesto-I		2607021191000	915 MHz	-2 dBm / 0.6 mW	550 m	2 m / 38.4 kbps	RF-Pad	38.4 kbps (0) 2.40 kbps (1) 100 kbps (2)	51	P2P, star, mesh	30 mA	30 mA	3 µA	2 - 3.6 VDC	transparent, command	17 x 27 x 3.8 mm	WE-FP-1	MSP430 + TI-CC1125	FCC, IC	✓	✓
		2607021191010	915 MHz	15 dBm / 31 mW	700 m	2 m / 38.4 kbps	RF-Pad	38.4 kbps (0)	51	P2P, star, FHSS	30 mA	53 mA	3 µA	2 - 3.6 VDC	transparent, command	17 x 27 x 3.8 mm	WE-FP-1	MSP430 + TI-CC1125	FCC, IC	✓	✓
Telesto-III		2609011091000	915 MHz	14 dBm / 25 mW	40 m	2 m / 400 kbps	PCB	400 kbps (6)	51	P2P, star, mesh	8 mA	26 mA	0.2 µA	2.2 - 3.8 VDC	transparent, command	17 x 27 x 3.8 mm	WE-FP-1+	TI-CC1310	FCC, IC		
		2609011191000	915 MHz	14 dBm / 25 mW	800 m	2 m / 400 kbps	RF-Pad													✓	✓
Themisto-I		2609041191000	915 MHz	25 dBm / 315 mW	10.5 km	6 m / 30 kbps	RF-Pad	400 kbps (6) 240 kbps (8) 30.0 kbps (9)	51	P2P, star, mesh	12 mA	400 mA	0.9 µA	2.2 - 3.7 VDC	transparent, command	17 x 27 x 3.8 mm	WE-FP-1+	TI-CC1310	FCC, IC	✓	
Triton		2603011021000	2400 MHz	0 dBm / 1 mW	600 m	2 m / 1.50 kbps	Chip	1.50 kbps (1) 3.00 kbps (2) 6.00 kbps (3) 12.0 kbps (4) 24.0 kbps (5) 48.0 kbps (6) 72.0 kbps (7)	20	P2P, star	10 mA	38 mA	1 µA	1.9 - 3.6 VDC	command	16 x 27.5 x 3.2 mm	WE-FP-2	STM32 + EM9209	CE, FCC, IC	✓	
		2603011121000	2400 MHz	10 dBm / 10 mW	5 km	6 m / 1.50 kbps	RF-Pad													✓	
Thalassa		2606031021000	2400 MHz	-6 dBm / 250 µW	150 m	2 m / 1.50 kbps	Chip	1.50 kbps (1) 250 kbps (default)	166	P2P, star	21 mA	25 mA	6 µA	2.7 - 3.6 VDC	transparent, command	17 x 30.8 x 3.6 mm	WE-FP-3	MSP430 + TI-CC2500	CE, FCC, IC	✓	✓
		2606031121000	2400 MHz	0 dBm / 1 mW	450 m	2 m / 1.50 kbps	RF-Pad													✓	
Highlight: Thyone-I		2611011021000	2400 MHz	4 dBm / 2.5 mW			SAS -> PCB	125 kbps (0) 500 kbps (1) 1.0 Mbps (2) 2.0 Mbps (3)	39	P2P, star, mesh	7.7 mA	18.9 mA	0.4 µA	1.8 - 3.6 VDC	transparent, command	12 x 8 x 2 mm	WE-FP-4+	nRF52840	CE, FCC, IC, TELEC	✓	✓
			2400 MHz	8 dBm / 6.3 mW	750 m	2 m / 125 kbps	SAS -> RF-Pad														

Cellular

Bluetooth®

Wi-Fi

Proprietary

Combined

Mesh

Wireless M-Bus

Build Your Own Firmware

GNSS

Sensors

OUR STRONGEST: PROPRIETARY 868 MHz



Tarvos-III
Long range radio module
868 MHz



Thebe-II
Long range radio module
868 MHz

Characteristics

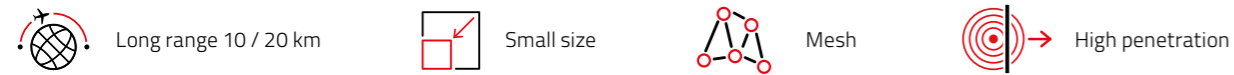

- 2 products - 1 footprint
- Footprint compatible to 915 MHz modules
- Flexibility in design
- Transparent mode
- Flexible addressing
- Powerful
- Interoperable Tarvos-III and Thebe-II
- Adjustable output power

Correlation Range - Data Rate

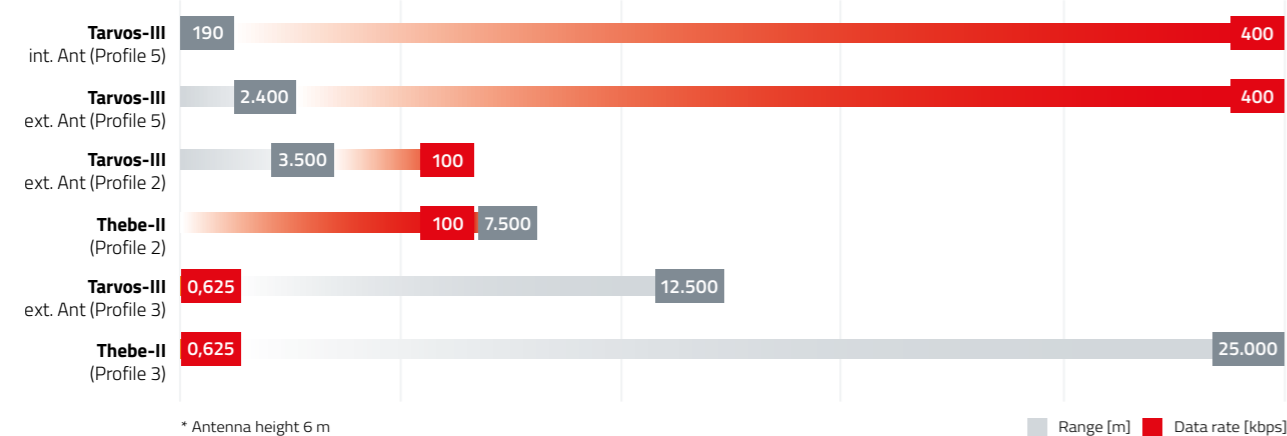

Differences

	Tarvos-III	Thebe-II
Output power	14dBm / 25 mW	27 dBm / 500 mW
Range	300 m / 10 km	20 km
RF channels	41	4
Power consumption	8 mA / 26 mA / 0,2 µA	12 mA / 500 mA / 0,9 µA
Antenna	PCB / external	external
	we-online.com/Tarvos-III	we-online.com/Thebe-II

EXCHANGEABILITY 868 MHz / 915 MHz

Compatibility Tarvos-Thebe-Telesto-Themisto Series

- Footprint compatible RF-modules
- Alternative usage by only changing the RF-module
- No change in the HW on Host-side required
- Flexible use of both frequencies for different regions possible
- 68 MHz and 915 MHz exchangeable
- Using Low or High Power modules for different ranges
- Modules with 14 dBm (25 mW): Tarvos-III and Telesto-III
- Modules with 27 dBm (500 mW): Thebe-II and Themisto-I



Replacing 868 MHz Radio Modules by their 915 MHz counterparts
we-online.com/ANR015

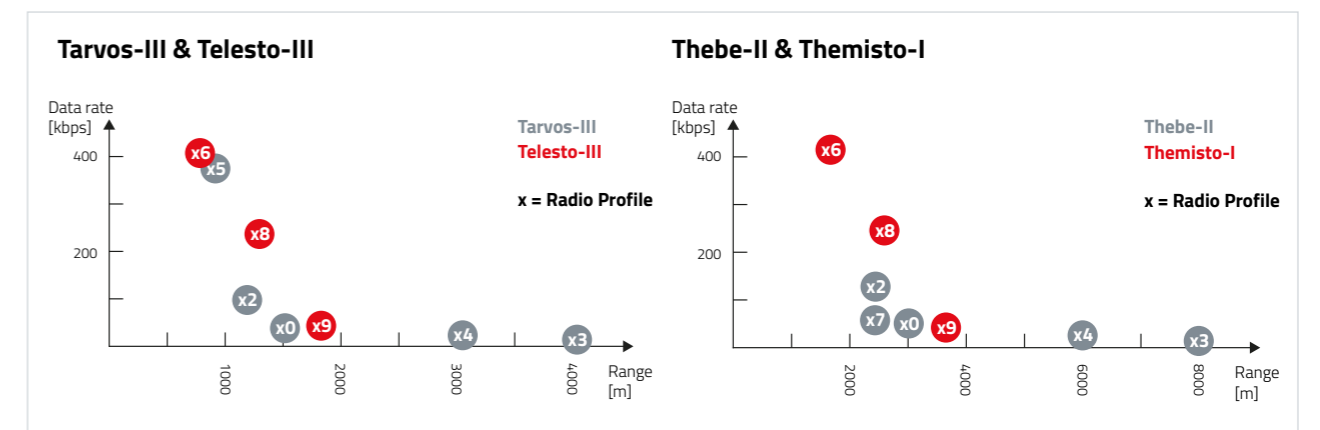

In case, the **Tarvos-III** is replaced by a **Telesto-III** radio module, the following facts have to be considered:

Feature	Information	Actions needed
Form factor & footprint	Both modules have the same form factor and footprint.	None
Pinout	Both modules are pin compatible.	None
Antenna	Both modules are available with integrated antenna and a 50 Ω antenna pad to connect an external antenna.	In case of external antenna, check whether the connected 868 MHz antenna can be also used for 915 MHz.
UART protocol	Both modules provide a command interface using the same commands and functions.	None
Radio configuration	<ul style="list-style-type: none"> The radio profile 6 of the Telesto-III is comparable in range and speed with the radio profile 5 of the Tarvos-III. In case, the Tarvos-III uses another radio profile, the range of the Telesto-III is lower, but data rate is higher, such that the data can be transmitted much faster. The channel numbering changes from 100 - 140 (868 - 870 MHz) to 200 - 252 (902 - 928 MHz). 	<ul style="list-style-type: none"> Check the range requirements of your application. Use the new channel numbers in your application code.
Certification	The 915 MHz range is regulated in North America by the FCC USA and ISED Canada.	Re-testing of the end-device is needed to determine unwanted emissions.

In case, the **Thebe-II** is replaced by a **Themisto-I** radio module, the following facts have to be considered:

Feature	Information	Actions needed
Form factor & footprint	Both modules have the same form factor and footprint.	None
Pinout	Both modules are pin compatible.	None
Antenna	Both modules are available with a 50 Ω antenna pad to connect an external antenna.	Check whether the connected 868 MHz antenna can be also used for 915 MHz.
UART protocol	Both modules provide a command interface using the same commands and functions.	None
Radio configuration	<ul style="list-style-type: none"> The radio profiles of the Themisto-I provide a faster radio transmission at the cost of range. The channel numbering changes from 129 - 132 (869.45 - 869.6 MHz) to 200 - 252 (902 - 928 MHz). 	<ul style="list-style-type: none"> Check the range and timing requirements of your application. Use the new channel numbers in your application code.
Certification	The 915 MHz range is regulated in North America by the FCC USA and ISED Canada.	Re-testing of the end-device is needed to determine unwanted emissions.

OUR SMALLEST: PROPRIETARY 2.4 GHZ



Thyone-I

Proprietary radio module 2.4 GHz



Characteristics

- Long life battery driven application with sleep current = 0.4 μA
- Global availability 2.4 GHz license free band
- Mesh
- Nano SIM size

- High throughput up to 400 kbit/s
- Range up to 750 m
- Control the GPIOs via remote and local access
- Easy serial cable replacement (transparent mode)
- Test modes for RF measurements
- Smart antenna selection (2-in-1 module)
- Encryption (AES128)
- Certifications: CE, FCC, IC, TELEC

Choose between Long Range and High Throughput

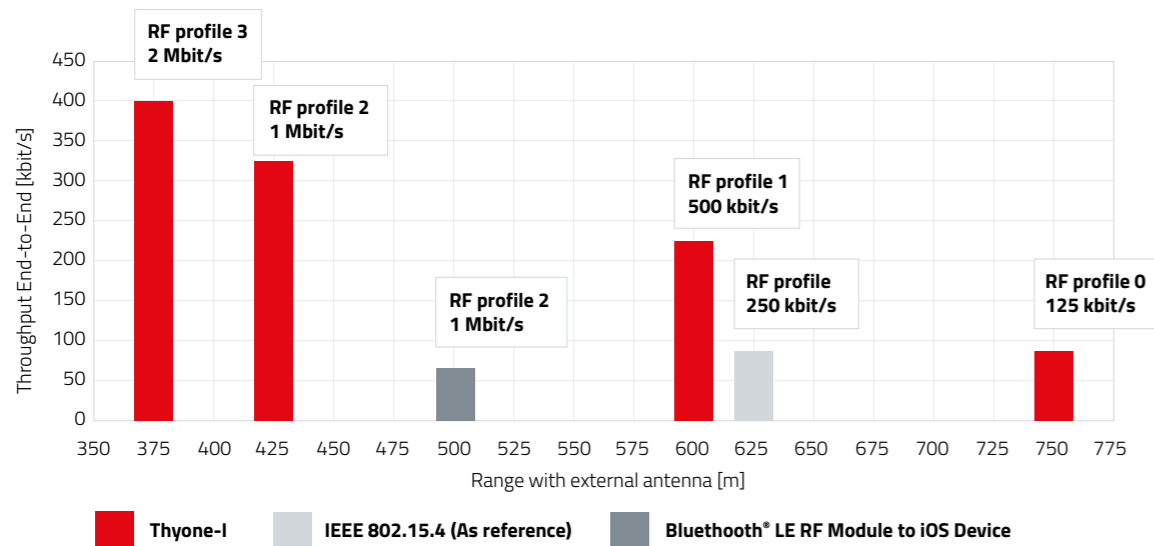

we-online.com/Thyone-I

EXCHANGEABILITY 2.4 GHZ

Exchangeability Thyone-I and Proteus-III

- Footprint compatible RF-modules
- Flexible use of both technologies possible
- Alternative usage by only changing the RF-module
- Future-proof circuit with adaptable interface
- No change in the HW on Host-side required

Take future trends into account and keep the flexibility!

Committing today on a wireless technology for tomorrow seems impossible. How nice would it be to expand your application with different radio protocols at any time without any layout changes. Würth Elektronik offers you a high degree of freedom with the radio module footprint. It is one quality proven hardware base, that prevents you from enormous costs of re-design in future already today. Choose between a Bluetooth®, Wirepas™ or proprietary radio module or the combined variant of proprietary and Bluetooth®.

4-in-1 Footprint

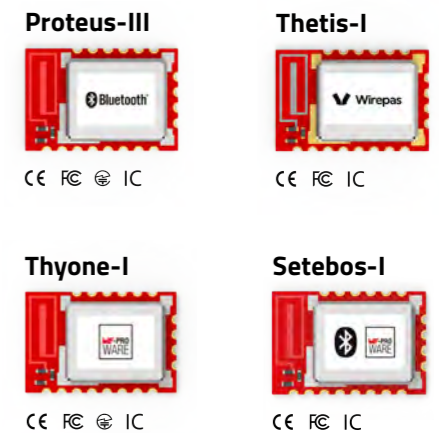

Proprietary Application with Thyone-I

- For applications with enclosed communication
- Communication invisible for smart devices
- Connection to a standard device only with a certain USB-radio stick possible
- Connected sensors building up a secure network

Usecase

- Secure network set up
- Easy connection between the nodes
- Extending interfaces by connecting a USB-radio stick
- A gateway connecting securely to the network provides the combined result to the user via Bluetooth, Wi-Fi, Cellular, MQTT or on any platform

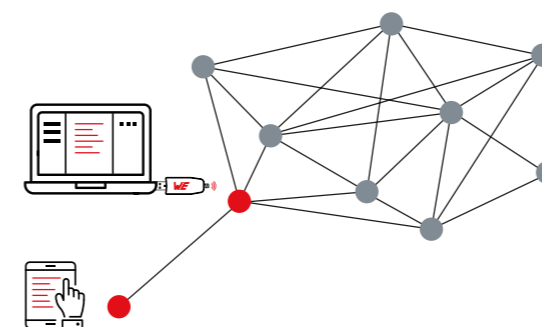

Bluetooth® Application with Proteus-III

- Connecting directly to smart devices
- Parameterization of a sensor
- Reading out results from a measuring device

Usecase

- Connecting manually to each sensor via smart device
- Easy and smart consumer-oriented

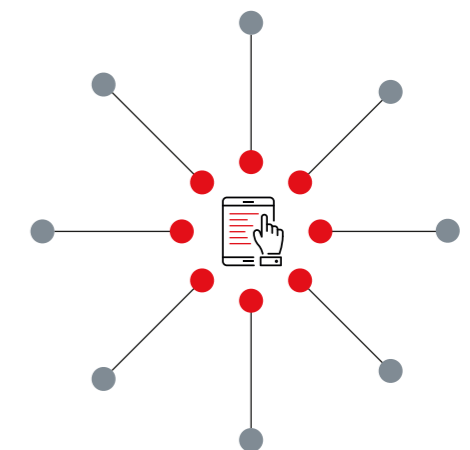

ADDED VALUES

Development Tools

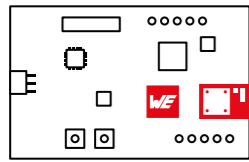

Eval Boards

- Easy testing
- Rapid prototyping
- FTDI integrated (UART to USB)
- Pins available on header
- Current measurement



we-online.com/EVAL-BLE



More information on page 150



USB-Radio Stick

- USB-FTDI-RF-Module
- Range extension in Flooding Mesh networks
- Radio connection for computer



we-online.com/USB-BLE



More information on page 150



Smart Commander

- PC-Tool for easy testing
- AT-Commands as buttons
- Monitoring UART-Communication
- Export Commands for easy integration in the former HOST-Controller



we-online.com/SmartCommander

AppNotes



Wireless Connectivity Software Development Kit (SDK)

we-online.com/ANR008



Range Estimation

we-online.com/ANR010



Replacing 868 MHz Radio Modules by their 915 MHz counterparts

we-online.com/ANR015



Proprietary Migration Guide – Replacing a proprietary Radio Module by its successor

we-online.com/ANR016

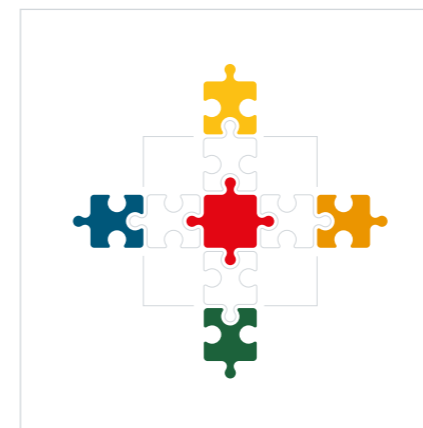

Software Development Kit

- Typically as C-Files, for mobile Apps platform specific languages
- For comfortable coding of:
 - The HOST-controller system
 - PC Applications & Mobile Apps
- Code examples in Application notes and Manuals



we-online.com/WCO-SDK

COMBINED



OUR COMBINED: PROPRIETARY 2.4 GHZ & BLUETOOTH® LOW ENERGY 5.1



Setebos-I New

Bluetooth® Low Energy 5.1 Standard & Proprietary radio module 2.4 GHz

CE FCC IC



Characteristics

- Security & Encryption
- High throughput
- Long range
- Smart antenna selection
- Long life battery driven application with sleep current = 0.4 µA
- Global availability 2.4 GHz license free band
- Mesh
- Nano SIM size

- Bluetooth® 5.1 qualified end product
- Nano SIM size - 8 x 12 x 2 mm
- ARM® Cortex®-M4 32-bit processor with FPU, 64 MHz
- Nordic Semiconductor SoC nRF52840
- 1 MB flash memory, 256 kB RAM
- Up to 8 dBm output power for higher range
- 1 Mbit and 2 Mbit radio and long range modes
- High throughput mode, 4 times higher throughput with payload size of up to 964 bytes
- Scan and Connect in long range mode
- Improved throughput with transparent UART interface (Peripheral only mode)
- Serial data transmission (Smart Serial Profile)
- LE Secure Connections (LESC)
- Connect (1:n / n:1) as central or peripheral
- 5 configurable digital GPIOs (local & remote)
- High throughput up to 400 kbit/s
- Range up to 750 m
- Control the GPIOs via remote and local access
- Integrated radio profiles for 125, 500, 1000 and 2000 kbit/s
- Easy serial cable replacement (transparent mode)
- Test modes for RF measurements
- Smart antenna selection (2-in-1 module)
- Encryption (AES128)
- Certifications: CE, FCC, IC

You don't know if Bluetooth® or Proprietary? Use both...



PRODUCT OVERVIEW	85
ADDED VALUES	90

OUR FASTEST: BLUETOOTH® LOW ENERGY 5.1



Proteus-III

Bluetooth® Low Energy 5.1 Standard with 2 MBit PHY and Coded PHY (long range)

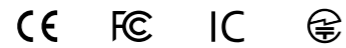

Characteristics

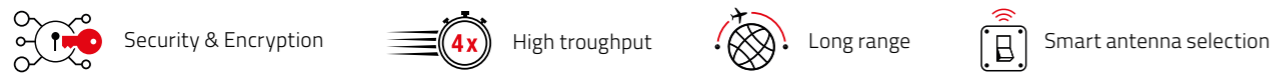

- Bluetooth® 5.1 qualified end product
- Nano SIM size - 8 x 12 x 2 mm
- ARM® Cortex®-M4 32-bit processor with FPU, 64 MHz
- Nordic Semiconductor SoC nRF52840
- 1 MB flash memory, 256 kB RAM
- Up to 8 dBm output power for higher range
- 1 Mbit and 2 Mbit radio and long range modes
- High throughput mode, 4 times higher throughput with payload size of up to 964 bytes
- Scan and Connect in long range mode
- Improved throughput with transparent UART interface (Peripheral only mode)
- Serial data transmission (Smart Serial Profile)
- LE Secure Connections (LESC)
- Connect (1:n / n:1) as central or peripheral
- 6 configurable digital GPIOs (local & remote)
- Smart antenna selection (2-in-1 Module)
- Also available as proprietary radio module (Thyone-I)
- Certifications: CE, FCC, IC, TELEC

we-online.com/Proteus-III

OUR SMALLEST: PROPRIETARY 2.4 GHZ



Thyone-I New

Proprietary radio module 2.4 GHz



Characteristics

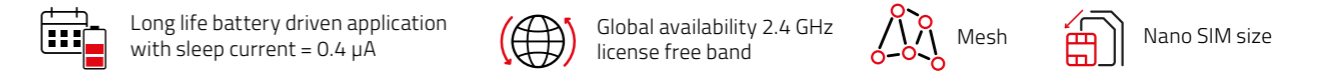

- High throughput up to 400 kbit/s
- Range up to 750 m
- Control the GPIOs via remote and local access
- Easy serial cable replacement (transparent mode)
- Test modes for RF measurements
- Smart antenna selection (2-in-1 module)
- Encryption (AES128)
- Certifications: CE, FCC, IC, TELEC

Choose between Long Range and High Throughput

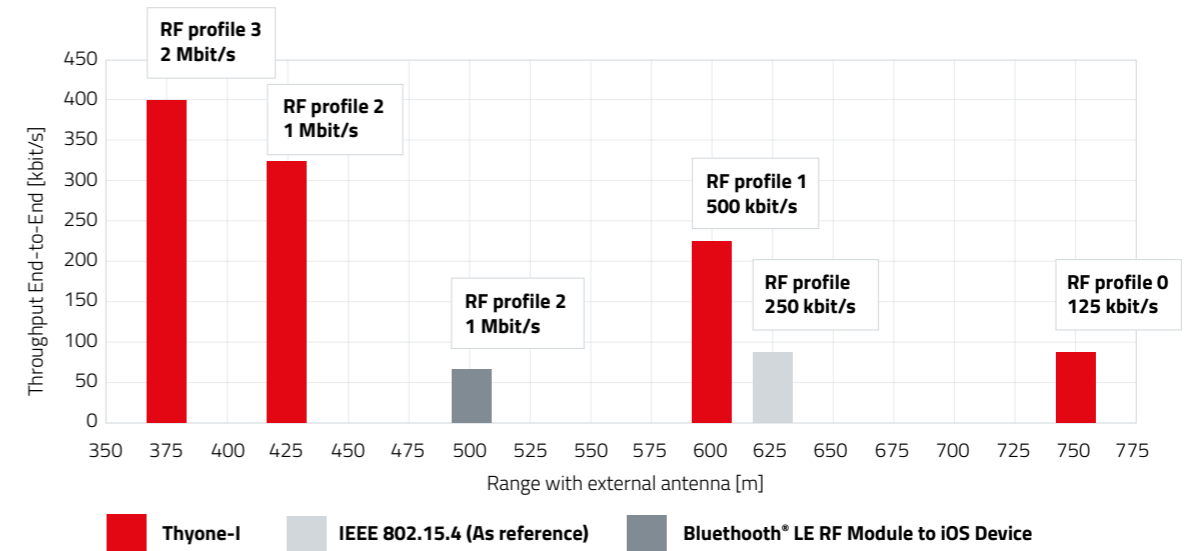

we-online.com/Thyone-I

EXCHANGEABILITY

2.4 GHZ

Exchangeability Thyone-I and Proteus-III

- Footprint compatible RF-modules
- Flexible use of both technologies possible
- Alternative usage by only changing the RF-module
- Future-proof circuit with adaptable interface
- No change in the HW on Host-side required

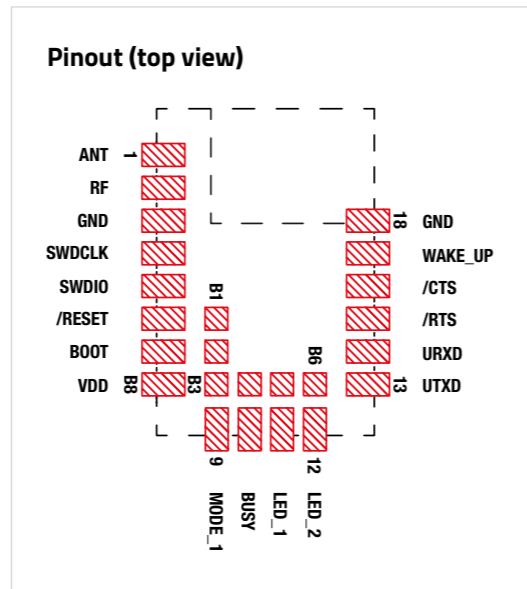

Proprietary Radio as Bluetooth® LE Alternative

- Connection only with authorized devices by the manufacturer
- Security aspect as argument for the endcustomers
- Closed communication is „invisible“ for Smart devices
- Higher throughput possible – no effort with big overhead of Bluetooth®
- Saving Bluetooth® Listing costs
- Business model to build the whole chain as user experience
- Binding the end customer to the product with additional accessory with the same communication



THE IDEA to connect wirelessly to a device:

- Parameterization for commissioning
- Start/stop measurement
- Read out results
- Notification danger
- Connecting for service
- Checking device state for predictive maintenance
- Recalibration

NO STANDARD radio protocol does fit

- Tried to implement Bluetooth® a few years ago:
 - Bluetooth® classic with too high energy consumption
 - Bluetooth® Listing Costs too high
 - Small quantities cannot carry the high costs
 - Bluetooth® LE not flexible enough for the idea
- Same is valid for Sub-GHz LoRa, SigFox, etc.



THE SOLUTION

Proprietary Communication as solution:

- Easy adaption possible
- Fitting perfectly to the needs
- No license costs arise
- Full control over application

Proprietary Application with Thyone-I

- For applications with enclosed communication
- Communication invisible for smart devices
- Connection to a standard device only with a certain USB-radio stick possible
- Connected sensors building up a secure network

Usecase

- Secure network set up
- Easy connection between the nodes
- Extending interfaces by connecting a USB-radio stick
- A gateway connecting securely to the network provides the combined result to the user via Bluetooth, Wi-Fi, Cellular, MQTT or on any platform

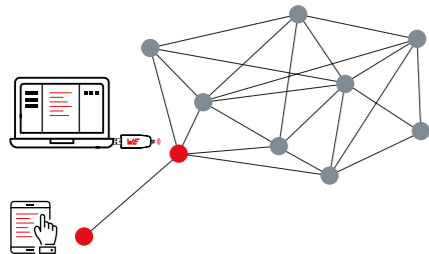

Bluetooth® Application with Proteus-III

- Connecting directly to smart devices
- Parameterization of a sensor
- Reading out results from a measuring device

Usecase

- Connecting manually to each sensor via smart device
- Easy and smart consumer-oriented

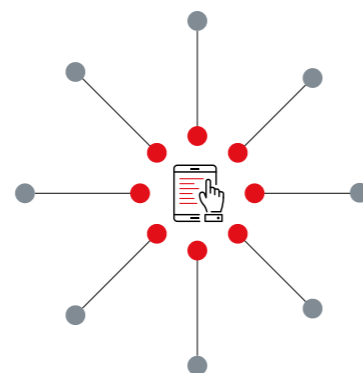

Webinar:

Bluetooth® LE vs 2.4 GHz Proprietary wireless



ADDED VALUES

Development Tools

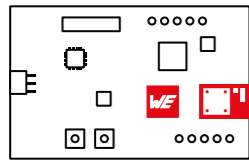

Eval Boards

- Easy testing
- Rapid prototyping
- FTDI integrated (UART to USB)
- Pins available on header
- Current measurement



we-online.com/EVAL-BLE



More information on page 150



Smart Commander

- PC-Tool for easy testing
- AT-Commands as buttons
- Monitoring UART-Communication
- Export Commands for easy integration in the former HOST-Controller



we-online.com/SmartCommander

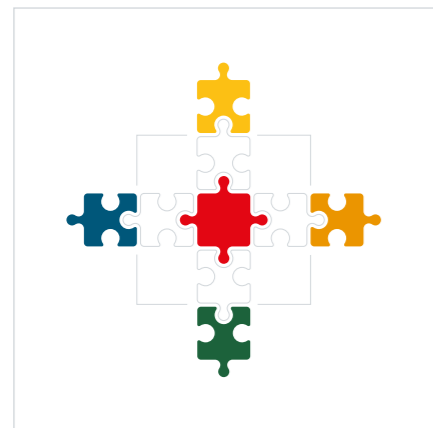

Software Development Kit

- Typically as C-Files, for mobile Apps platform specific languages
- For comfortable coding of:
 - The HOST-controller system
 - PC Applications & Mobile Apps
- Code examples in Application notes and Manuals



we-online.com/WCO-SDK

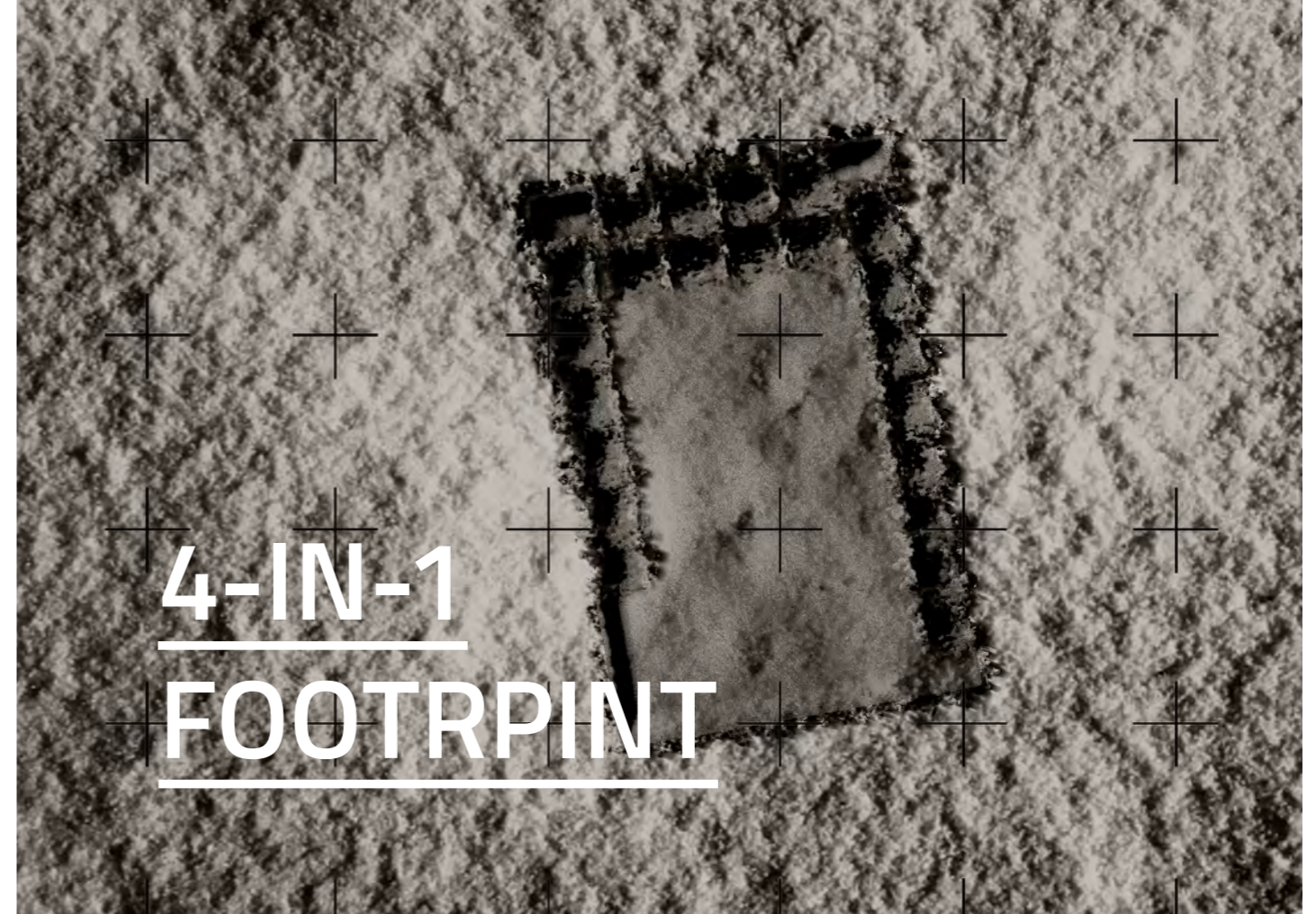

TAKE FUTURE TRENDS INTO ACCOUNT AND KEEP THE FLEXIBILITY!

Committing today on a wireless technology for tomorrow seems impossible. How nice would it be to expand your application with different radio protocols at any time without any layout changes. Würth Elektronik offers you a high degree of freedom with the radio module footprint.

It is one quality proven hardware base, that prevents you from enormous costs of re-design in future already today. Choose between a Bluetooth®, Wirepas™ or proprietary radio module or the combined variant of proprietary and Bluetooth®.

Proteus-III

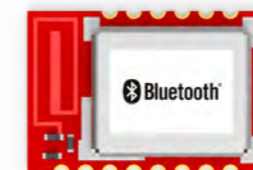

CE FC IC

Thetis-I



CE FC IC

Thyone-I



CE FC IC

Setebos-I

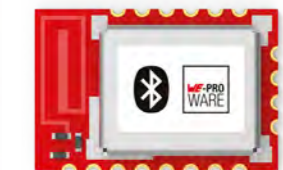

CE FC IC

MESH



INTRODUCTION	83
PRODUCT OVERVIEW	97
ADDED VALUES	98

INTRODUCTION MESH OVERVIEW

What's a Mesh?

A Mesh is a network of multiple devices connecting to each other. The nodes connect directly to other nodes and there is no need of a master controlling the actions. In general there are more connection paths between the source and the target. The information is handed over from one node to the other.

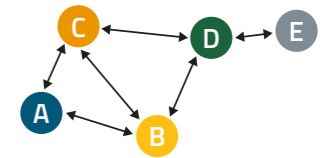

EXAMPLE Sending a message from A to D

Flooding Technique

Each node just forwards the message

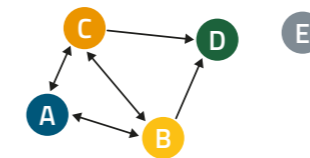

- + Easy to use:
 - No network organization (installation, change)
- + Size does not matter
- Increased traffic:
 - Duty Cycle problems

Routing Technique

The network master or each node knows the path

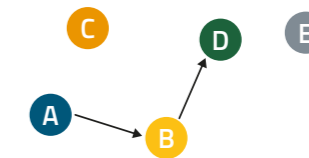

- + Shortest/Cheapest path
- Extra network organization traffic
- Size limitations (master handled)
- Less robust on network changes:
 - Master has to know when adding/removing a node

Asynchronous

Messages can be transmitted at any times



- + Fast
- + No installation effort
- + No size limitations
- Energy consuming (~100% RX)
- High probability for radio packet collision

Synchronous

All nodes are synchronized and transmit/receive at determined slots

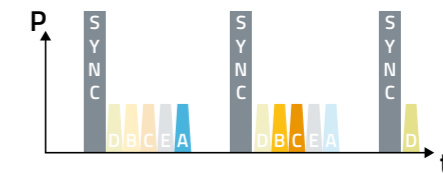

- + Energy efficient
- + Time and frequency hopping possible
- Synchronization effort (master needed)
- Size limitation
- Low throughput/High latency

WIREPAS MASSIVE

What is Wirepas?

Wirepas is an international company with headquarters in Tampere, Finland. Wirepas is specialized in IoT topics and offers the Wirepas Mesh stack (firmware only) and support to high volume customers. Würth Elektronik is in cooperation with Wirepas to integrate the Wirepas mesh stack into radio chips as well as offering service to our customers to develop Wirepas mesh radio modules based on the existing Nordic Semiconductor nRF platform. Würth Elektronik is licensed to develop, support and sell standard and custom Wirepas mesh radio modules.

What are the strengths of Wirepas Mesh protocol?

Traditional mesh networks suffer in large scale from complex networking tables, congestion and bandwidth issues. Wirepas overcomes these issues by removing network's infrastructures and decentralizing network's intelligence on the nodes. All networking decisions are done locally by the nodes. Every node:

- scans automatically the neighborhood and choose the best path to the sink
- adapts transmit power to neighbor proximity
- can act as sink, routing or non-routing node
- can work in low power or low latency mode
- chooses the best frequency to use locally
- has a high configurability, interference-tolerance, ultra-low energy consumption: Wirepas mesh software is ideal for large scale and battery-operated networks.

What is Wirepas Mesh?

Wirepas Mesh is a connectivity protocol for radio modules, optimized for large scale and energy efficient wireless mesh networks in the frequency 2.4 GHz. This innovative technology can be used to create large IoT networks, for example using battery-powered sensors, in which each node also functions as a router. On a single MCU solution, the application runs on the device itself. On a dual MCU solution, the application runs on a host microcontroller.

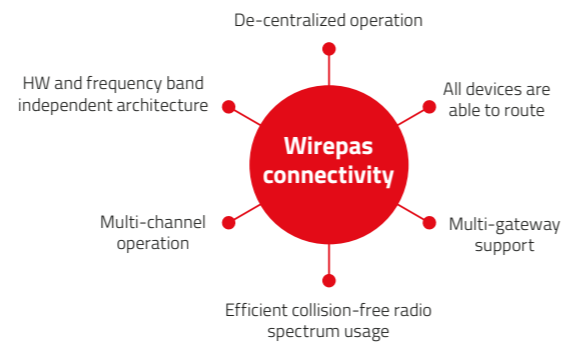

BLUETOOTH® MESH

Bluetooth® Mesh

Bluetooth® released a Mesh Version in 2017. It is an own standard and strictly speaking not part of the Bluetooth standard. It uses Bluetooth® Low Energy link layer and radio and prefers Bluetooth® 5.0 or newer due to long advertising packets. As a flooding Mesh it includes time to live (TTL) in the messages. Security is approved by application key and network key.

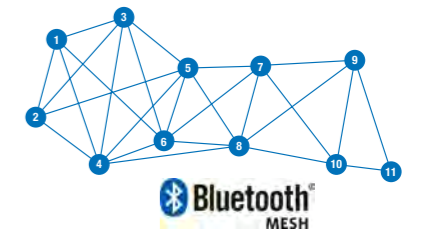

How does it work?

The Network has nodes with different features. A node sends and receives data. Additionally there are relay nodes forwarding defined data. Special Low Power nodes are rarely active and only then send/receive data. The corresponding node is the Friend collecting data for the Low Power node. Only Low Power Nodes can be operated, since other nodes permanently receive and relay data. Bluetooth® Low Energy devices (i.e. smart phones) can connect temporarily to push/pull data to/from the network. Nodes have to subscribe to groups to receive messages and publish to groups to transmit messages.

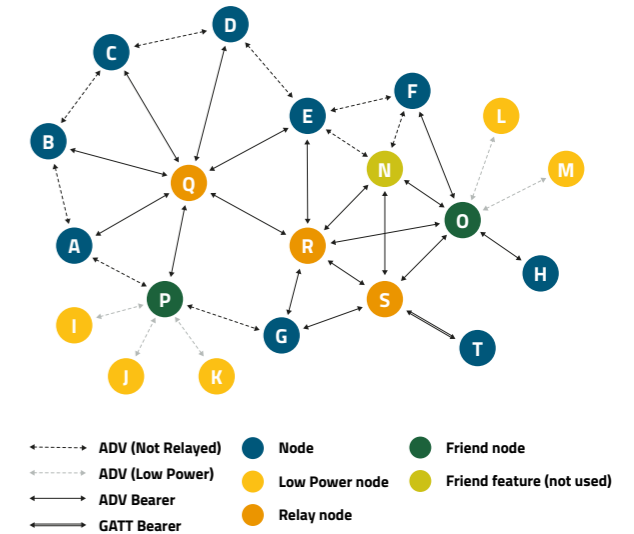

Mesh Models

Bluetooth® Mesh Models define basic functionality of nodes on a mesh network. Mesh Profile Specification defines foundation models used to configure and manage the network. Mesh Model Specification includes models defining functionality that is standard across device types. Those Models are: Generics (general functions), Timing, Lighting and Sensors.



Is a Bluetooth® Mesh the best Solution for my Scenario?

To sum it up, there are the following benefits and penalties in using Bluetooth® Mesh, which has to be considered:

- + Extending the range by repeating messages, a self-healing network as there is the possibility of different routes of the messages make the Bluetooth® Mesh very useful.
- On the other hand it must be mentioned, that the performance of a Bluetooth® Mesh is quite poor. You could send 30 Bytes per 100 ms leading to a throughput of 2400 bps. Further, the Network must be installed by the end user himself, so technical knowhow is recommended. Furthermore each node has to be added to the network and provided with authentication and encryption keys which could make it time-consuming for the user.

Main Benefits of Wirepas Mesh

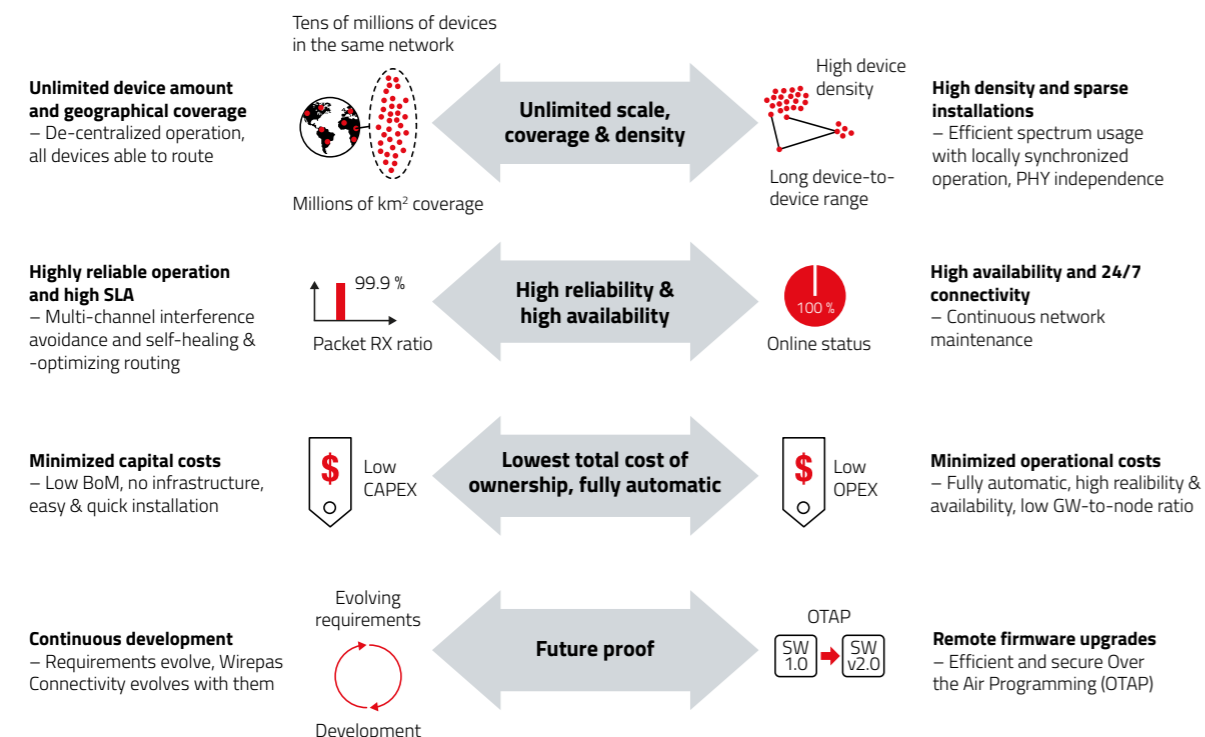

MESH IN WE RADIO MODULES

Asynchronous Flooding Mesh

An asynchronous flooding mesh is integrated into Thyone-I, Tarvos-III, Thebe-II, Thelesto-III, Themisto-I & Setebos-I. Suited for applications:

- using small/medium size mesh networks (much traffic due to flooding technique)
- where current consumption does not play a role (always on RX or TX).



WE-PRO WARE	WE Radio Module
Latency	😊
Current consumption	😡
Throughput	😐
Maximum number of nodes	😐
Installation effort	😊
Robustness	😊

Comparison Bluetooth® Mesh – Proprietary Mesh – Wirepas Mesh

	Nodes	Latency	Power
Bluetooth® Mesh	+	–	–
Wirepas Mesh	++	–	+
Proprietary Mesh	+	+	++

Comparison Asynchronous Flooding & (A)Synchronous Routing

We need a mesh solution that covers large power sensitive applications. Suited for applications that are battery operated, like sensor networks

Routing mesh integrated into Thetis-I.

	e.g. Thyone-I / Tarvos-III	Wirepas TDMA	Wirepas CSMA-CA
Latency	😊	😐	😊
Current consumption	😡	😊	😡
Throughput	😐	😡	😐
Maximum number of nodes	😐	😊	😊
Installation effort	😊	😊	😊
Robustness	😊	😊	😊
		Würth Elektronik Focus	Additional capabilities

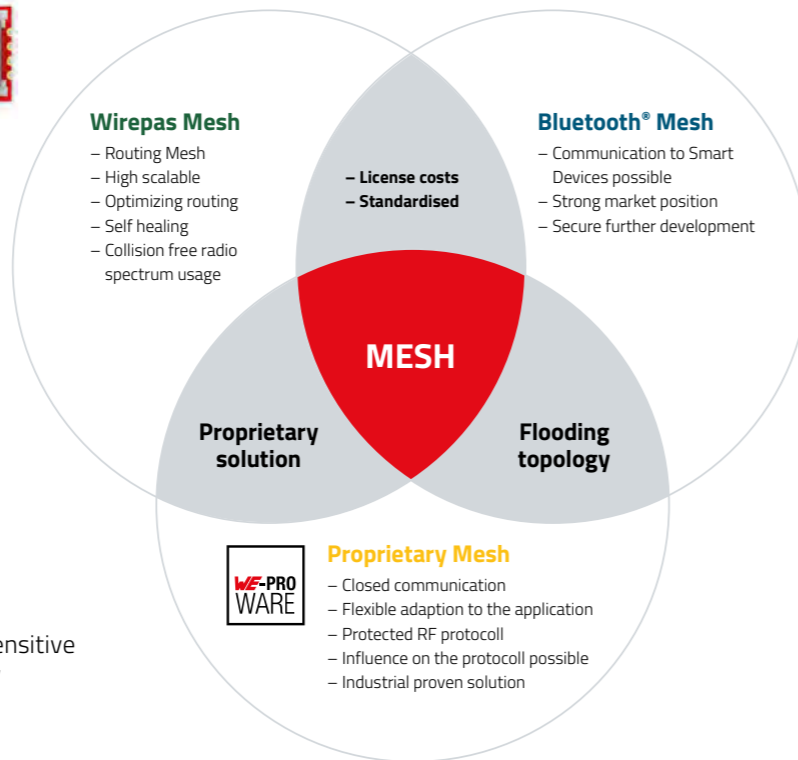

OUR MESHED WIREPAS 2.4 GHZ



Thetis-I

Radio Module 2,4 GHz with Wirepas Mesh protocol

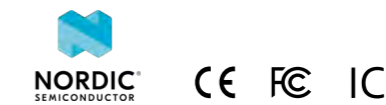

What are the key points from customer's perspective?

- ✓ Throughput
- ✓ Maximum number of nodes
- ✓ Installation effort
- ✓ Robustness

Characteristics



- Wirepas routing mesh
- Low energy and low latency mode
- Standalone (Single-MCU) or host-controlled (Dual-MCU) operation
- Standard or custom firmware solution available
- Nano SIM size - 8 x 12 x 2 mm
- ARM® Cortex®-M4 32-bit processor with FPU, 64 MHz
- ARM Cryptocell cryptographic unit
- Nordic Semiconductor SoC nRF52840

- 1 MB flash memory, 256 kB RAM
- Wirepas „Dual CPU“ model, c-mesh api for hosts available through github (<https://github.com/wirepas/c-mesh-api>)
- +6 dBm TX power (ERP: 4 dBm)
- Encryption, Integrity & Authentication
- Smart antenna selection (2-in-1 Module)
- Also available as proprietary radio module (Thyone-I) or Bluetooth® LE radio module (Proteus-III)
- CE, FCC, IC certification

Grow your Industrial IoT endlessly

The possibilities to use an industrial IoT mesh network in production are endless. The Wirepas Mesh grows organically and has automated interference avoidance so one network can handle multiple use cases and thousands of assets.

Benefits of Industrial IoT



Battery Lifetime

No additional mains-powered routers are required. Only large-scale wireless mesh connectivity technology in the market enabling battery-operated routers with over 5 year lifetime with 4000 mAh battery (1,5 packets per second).



Security & Reliability

Includes self-healing routing, multi-channel operation with local channel white/blacklisting. Proven over 99.99% reliability in large-scale & high interference buildings. Secure connectivity with industry standard AES-128 encryption.



Easy Retrofit

Easy retrofit is required due to factory floor design, large number of unsensored machinery and large number of outdated sensors that need replacement. Easy battery-operated mesh network with our sensors can be installed by anyone and anywhere.



Future Proof

Enables not only lighting control, but environmental sensing and asset tracking in the same wireless network. Any device in the network can be updated over the air. Interoperable with BLE devices.

ADDED VALUES

Development Tools

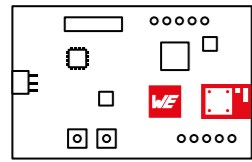

Eval Boards

- Easy testing
- Rapid prototyping
- FTDI integrated (UART to USB)
- Pins available on header
- Current measurement



we-online.com/EVAL-Mesh



More information on page 150

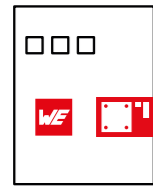

Sensor Node

- Easy testing
- Sensors onboard
- Rapid prototyping
- CR2032 battery powered
- setup Wirepas network immediately



we-online.com/Sensor-Node



More information on page 150

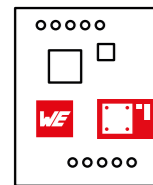

Mini Eval Boards

- Small and cheap
- USB connection with FTDI-cable possible (available as accessory)



we-online.com/EVAL-Mesh



More information on page 150



USB-Radio Stick

- USB-FTDI-RF-Module
- Radio connection for computer



we-online.com/USB-Mesh



More information on page 150



Wirepas Commander

- Easy testing
- AT-Commands as buttons
- Monitoring UART-Communication
- Export Commands for easy integration in the former HOST-Controller



Antenna

- 2.4 GHz external Antenna Himalia

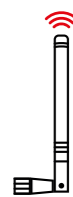

ACCESSING WIREPAS MASSIVE TECHNOLOGY

Wirepas partner

Acting as Wirepas partner, Würth Elektronik delivers modules with Wirepas firmware pre-flashed on the well-proven Thyone-I/Proteus-x hardware platform. Through a unique cooperation model, Würth Elektronik makes the advantages of the Wirepas technology accessible to small and middle sized businesses.



Wirepas

No License agreement or monthly rate – ONLY Royalty per piece (2.50 €)

Paid from customer to WE, from WE to Wirepas. Focus on small- and medium-size customers with no MOQ.



Wirepas + Competitor

License agreement with Wirepas needed. Including monthly rate: Royalty per piece (2.50 €)

Wirepas cannot follow and support customers requiring small quantities.

The process

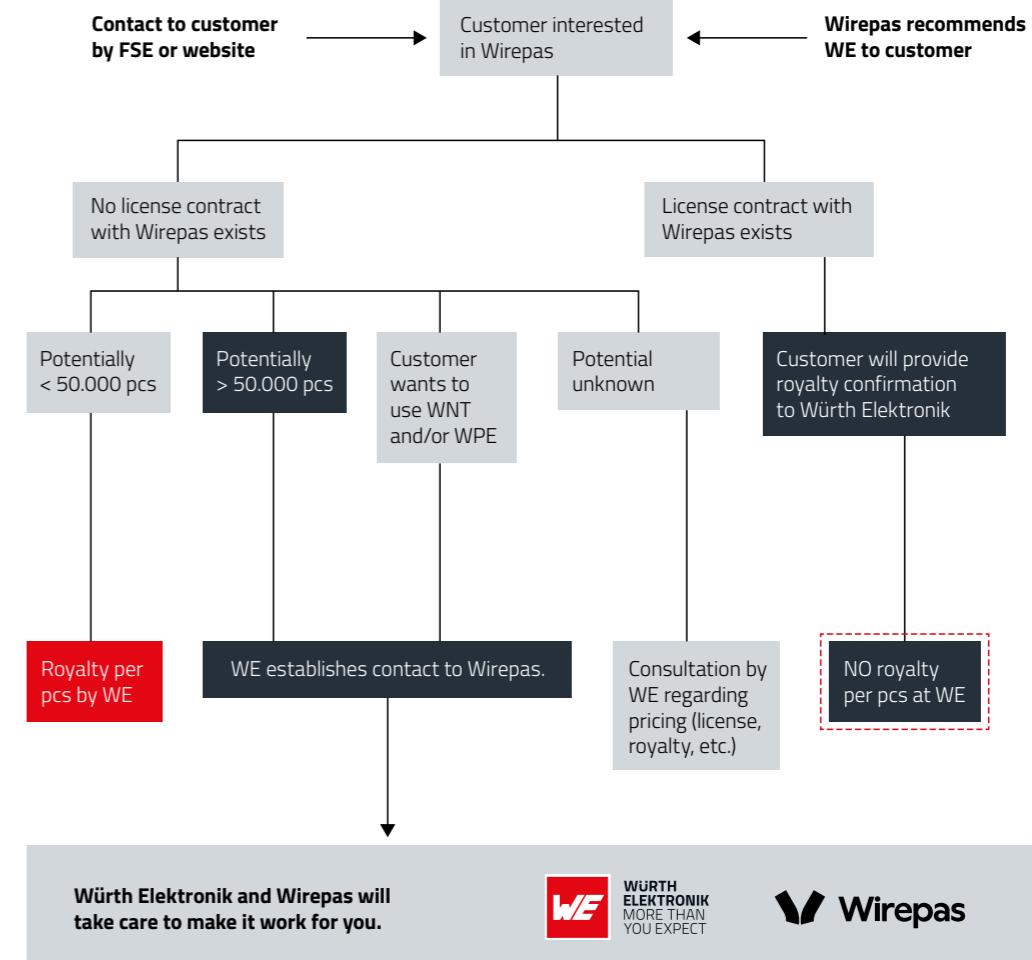

USER APPLICATION

INDUSTRIAL IOT

Wirepas Mesh is the perfect fit for Industrial IoT

The manufacturing industry has started seeing a growing need for monitoring the condition of their assets and to perform predictive maintenance if needed. The challenge is that smart industries require an industrial IoT connectivity solution, a self-healing mesh network that can handle a demanding radio environment.

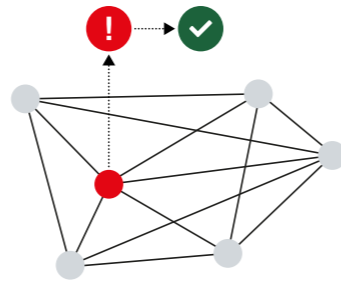

Predictive Maintenance

Machines, devices and equipment in production are lasting investments and keeping them operative is key. The sensors measure the condition data for the machines, devices and equipment and trigger predictive maintenance if needed. This reduces the need for multiple days of production halt to a few hours of maintenance.



Leakage Control

Pipes, ducts and vents carry and control many gas and liquid in production and from production plants to use. Monitoring and controlling valves and levers with sensors to ensure there are no leakages saves both money and the environment. The high number of sensors require a robust IoT connectivity to operate securely.

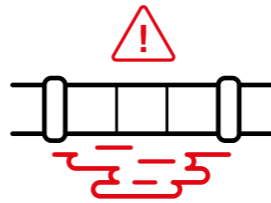

Monitoring and Measuring of Material Levels and Condition

Tanks, containers, vessels and sewage systems may carry dangerous liquids, gasses or material and the use levels need to be ensured to make sure safety and productivity is in check. Sensors may also keep tabs on for example safe temperature or ambient light levels to prevent accidents from happening.



RedLore – Container Tracking

RedLore Smart Sensors can be used in a large range of applications thanks to the wide variety of built-in sensors.

The Smart Sensors have the Wirepas Mesh Network Communication protocol inside: Every device is a wireless router and can act as a repeater for other nodes. As a result very large physical networks with 1000's of nodes can be built as long as every node can connect to a node which is closer to the gateway. At the same time every node remains low power and can work uninterruptedly for years on a small battery.

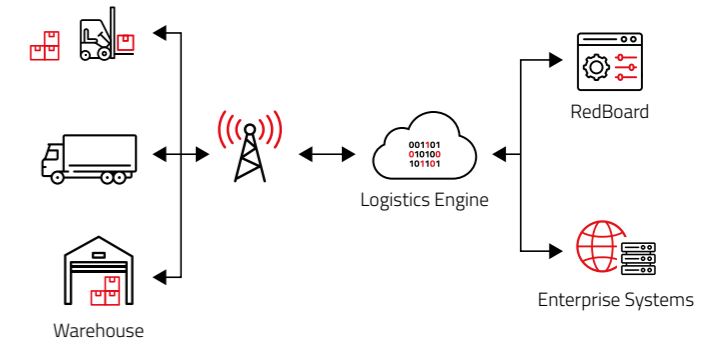

Different variants are available, each with different sensor sets and a long-life industrial LiSOC12 battery for up to 10 years of battery life. The sensing parameters (e.g. update rate) can be changed to suit the application needs.

The Smart Sensors send their data to a gateway. The accompanying Mobile App connects through the built-in NFC 'tap'- interface, allowing configuration and diagnostics of a device. The same functions are available from the gateway using the Remote Functions API.

Condition Monitoring

Condition monitoring can be expensive - which is why up to 95 percent of all aggregates in a production plant aren't monitored or are monitored sporadically, which leads to high risks for unplanned downtimes.

With a condition monitoring system you can monitor hundreds of aggregates within a few hours. Thus monitoring is simple, fast and cost-efficient.

The expandable system works for almost all aggregates and detects potential damage, imbalances and misalignments already weeks in advance.

The final end solution can consist of:

- Wireless sensors to monitor machine and equipment data
- A gateway that receives the sensor data and transmits it into the cloud
- A digital service that evaluates this data and provides professional error analyses - comfortably via smartphone or desktop application

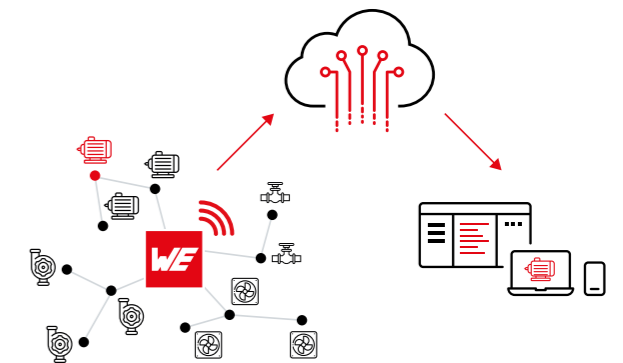

WIRELESS M-BUS



INTRODUCTION	103
PRODUCT OVERVIEW	105
ADDED VALUES	107

INTRODUCTION

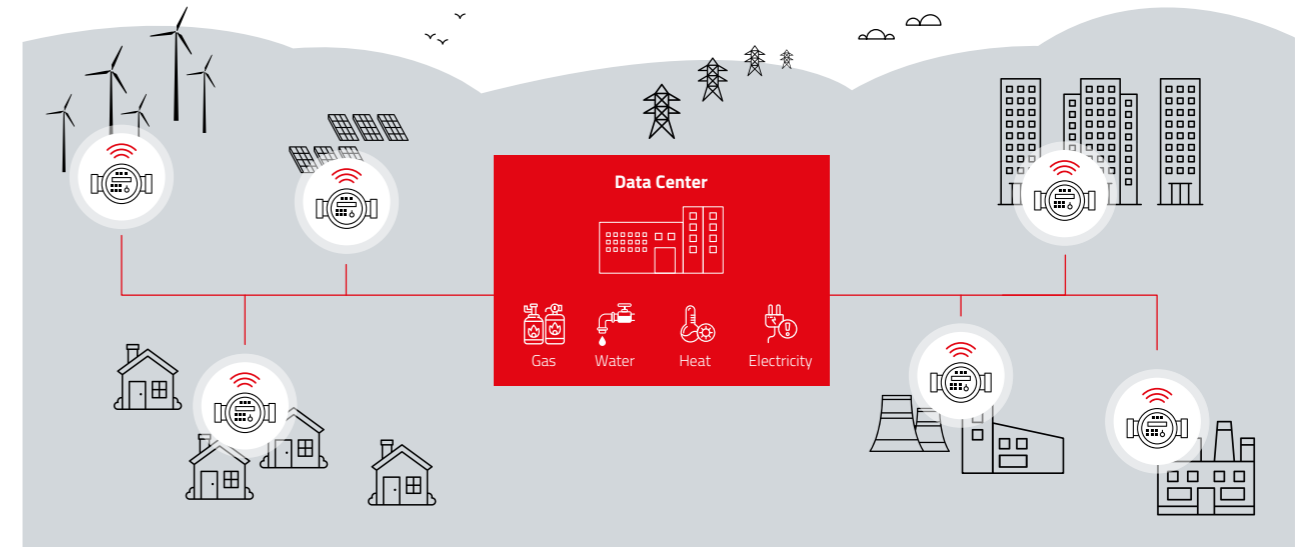

Wireless M-Bus

Wireless Meter Bus (wM-BUS) is the extension of the meter Bus (M-BUS) with a wireless protocol and role scheme for handling communication over a standardized wireless communication interface between meters and data loggers – so called smart meter gateways (SMGW). This scheme is specified by the European standard EN 13757 and its sub-standards. The motivation of this standard is to allow an automated measuring and processing of data, track the usage of resources and to optimize provisioning in order to create an “Advanced Metering Infrastructure” (AMI).

Such Smart grid / meter devices are typically battery operated and in need for a long range and robust wireless communication. This is the reason for using the Sub GHz frequencies in the free ISM Bands. EN13757-4 is specifying radio options in the 169 MHz, 434 MHz or 868 MHz band, regarding to the region.

In between those frequencies there are different modes with different functions. In the table below you can see those specifications.

Mode	Frequency	Uni-/Bidirectional	Description of Use
S1, Stationary	868.3 MHz	Uni	Send data a few times per day. Optimized for battery operation and stationary operation. 32.7 kbps
S1-m, Stationary	868.3 MHz	Uni	Same as S1, but optimized for mobile receiver
S2, Stationary	868.3 MHz	Bi	Same as S1, but bi-directional communication
T1, Frequent transmit	868.95 MHz	Uni	Send data every few seconds. Configurable interval. 100 kbps
T2, Frequent transmit	868.95 MHz, 868.3 MHz	Bi	Same as T1, but bi-directional operation
C1, Compact	868.95 MHz	Uni	Unidirectional communication using NRZ coding. Similar to T1 but higher data-rate, 50 kbps. Stationary operation
C2, Compact	868.95 MHz, 869.525 MHz	Bi	Same as C1, but bi-directional operation
N1a-f, Narrowband	169 MHz @ 12.5 kHz	Uni	Unidirectional, 4.8 kbps, stationary operation
N2a-f, Narrowband	169 MHz @ 12.5 kHz	Bi	Same as N1a-f, but bi-directional operation
N1g, Narrowband	169 MHz @ 50 kHz	Uni	Unidirectional, 19.2 kbps, stationary operation
N2g, Narrowband	169 MHz @ 50 kHz	Bi	Same as N1g, but bi-directional operation

GENERAL INFORMATION

Uni- / Bidirectional

The wireless M-Bus (EN13757-4) differentiates the transfer in a network in 2 directions: uplink and downlink. Where uplink is used when a "meter" sends data to a receiver ("other") and downlink is used when a sender ("other") sends data to a "meter".

This two directions are, depending on the wireless M-Bus mode, either symmetric (S and N modes) or asymmetric (T and C modes). Where symmetric means that the same radio parameters (radio data rate, coding, modulation, frequency) are used for both directions. On the other hand asymmetric means that those radio parameters are different for the two directions.

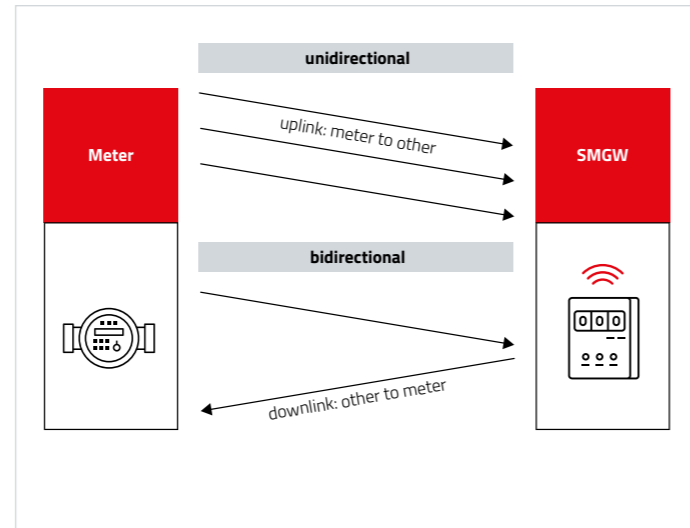

Payload

A wireless M-Bus mode containing a "1" means "sender only" so any radio frame reception is deactivated. Whereas a "2" in the wM-BUS mode means sender and receiver. The "sender only" mode of operation (e.g. C1 meter) has it's right to exist in a battery operated meter which does not need any information in the downlink direction and should operate in the order of 10 years with the integrated battery - which applies for the majority of meters today.

The payload of a wireless M-Bus frame is coded according to EN13757-3. Any meter reading value is located in one data block and the frame can contain one or multiple of such blocks. This allows the meter reading values to be transferred efficiently and in a well-defined yet flexible manner to provide interoperability. The drawback of this is, that the raw data of a wM-BUS frame is not readable for a human without parsing the data back into a readable format.

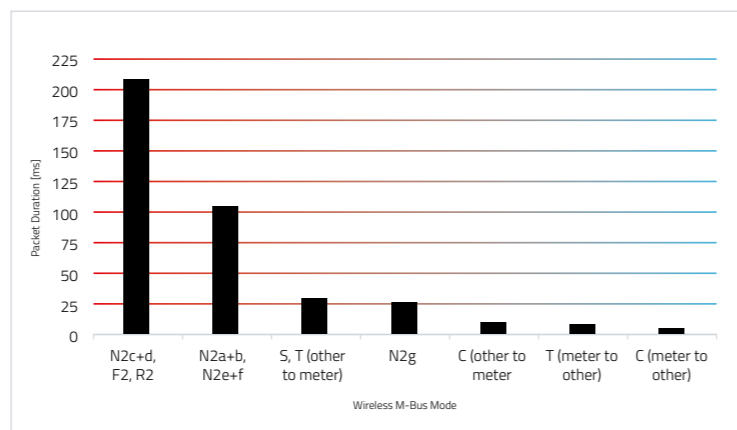

Different "Standards" in Europe



Europe in general

- EN13757; 169, 434 and 868 MHz wM-BUS Modes
- Based on OMS group recommendations



France

- „GrDF“ (Gaz réseau distribution France)
- EN13757 N-Modus, 169 MHz narrow band



Italy

- „CIG“ (Italian Gas Committee)
- Italian UNI TS11291 Specification
- EN13757 N-Modus, 169 MHz narrow band

PRODUCT OVERVIEW

	Mimas-I	Metis-I	Metis-II
Order Code	260701113000	2605041183000	2607021183000
Frequency	169 MHz	868 MHz	868 MHz
Wireless M-Bus modes	N1a to N1f N2a to N2f	S, T, C	S, T, C
Output Power	14 dBm	11 dBm	14 dBm
Power Consumption Rx	28 mA	22 mA	30 mA
Power Consumption Tx	59 mA	31 mA	53 mA
Power Consumption Sleep	10 µA	0.3 µA	3 µA
Supply Voltage min - max	2.0 - 3.6 VDC	2.2 - 3.6 VDC	2.0 - 3.6 VDC
Op. Temp	-40 ... +85 °C		
Max Datarate	4.8 kbps	100 kbps	100 kbps
Payload	255 Byte	255 Byte	255 Byte
Antenna	external		
LoS Range	3000 m	700 m	1000 m
LoS Test Conditions	2 m Antenna height / 2400 bit/s	2 m Antenna height / 32768 bit/s	2 m Antenna height / 32768 bit/s
Interface	UART		
Transparent Mode	✓	✓	✓
Repeater	-	-	✓
Certification	CE		
	we-online.com/ Mimas-I	we-online.com/ Metis-I	we-online.com/ Metis-II

OUR ANALYZER

WM-BUS TOOL

Wireless M-Bus Analyzer

The Wireless M-Bus Analyzer is a tool for receiving and parsing wireless M-Bus telegrams that comply with EN 13757-4:2013 transmitted by devices with role „meter“ or „other“. It currently supports both unencrypted and encrypted telegrams (supported encryption modes are: 0, 5, 7) in accordance with the OMS specification Vol2 V4.1.0 (draft June 2016) and EN13757-3:2013.



The data records in the telegrams are displayed in plain text by means of the integrated parser, which greatly simplifies the interpretation of a telegram. A review of the configuration settings or, for example, the meter readings can therefore be completed simply.

The Wireless M-Bus Analyzer is an excellent tool for analyzing errors and RF range of M-Bus devices. Thanks to the simplified representation and an integrated logging function, data can also be analyzed at a later time. The software only works in combination with a licensed AMB8665-AT2 USB stick. This USB stick acts as the receiver for telegrams from the meters and supports the S-, T- and C-mode.

Name	Part No.	Frequency [MHz]	Range* [m]	Modes	Compatible Modules
Metis-Simulator (AMB8665-M-S)	2607056283011	868	800	S, T, C	Metis-I (AMB8426-M), Metis-II (AMB8626-M)
		Wireless M-Bus Simulator Plug transmitting meter frames in S-, T-, C-mode for range estimation and meter simulation			
Metis-Analyzer (AMB8665-AT2)	2607057283011	Wireless M-Bus Receiver Plug plus smart meter software analyzer tool for wireless M-Bus			

* Range stated is calculated assuming line-of-sight. Antenna above ground 1.5 m and 6 dB margin. Actual range will vary based upon specific board integration, antenna selection and environment.

Characteristics

- Tool for monitoring and analysis of wireless M-Bus communication
- Packet content visualization
- Supports data records according to EN13757-3:2013 standard
- OMS (Open metering System) parser (according to OMS 4.1.0 draft 06/2016)
- Message parser for deep packet analysis incl. M-Bus application layer
- Decryption function (AES128) for security profiles A and B (encryption modes 5 and 7)
- Log feature (.xlsx, MS Excel) for offline analysis
- Various wireless M-Bus modes supported (S-, T- and C-Mode)

 we-online.com/wM-Bus-Analyzer

ADDED VALUES

Development Tools

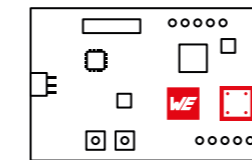

Eval Boards

- Easy testing
- Rapid prototyping
- FTDI integrated (UART to USB)
- Pins available on header
- Current measurement



we-online.com/EVAL-wM-BUS



More information on page 150



USB-Radio Stick

- USB-FTDI-RF-Module
- Range extension in Flooding Mesh networks
- Radio connection for computer



we-online.com/USB-wM-BUS



More information on page 150

AppNotes



ANR001 Metis-II Repeater Mode

we-online.com/ANR001

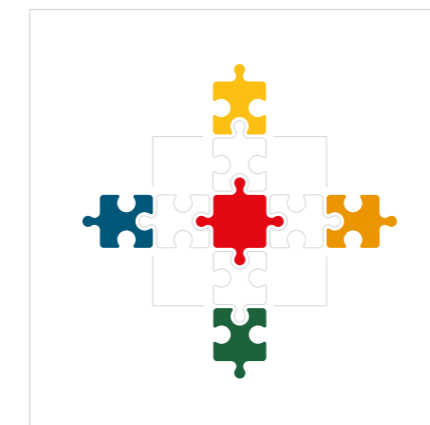

Software Development Kit

- Typically as C-Files, for mobile Apps platform specific languages
- For comfortable coding of:
 - The HOST-controller system
 - PC Applications & Mobile Apps
- Code examples in Application notes and Manuals



we-online.com/WCO-SDK

USER APPLICATION



A meter billing service provider switches from yearly manual reading to the use of wM-BUS based heat cost allocators and a smart meter gateway.

Advantages for the Customers

- + „Almost live“ data access on his currently use of resources including a “live” cost estimation instead of yearly billing
- + Comparison on a day-by-day basis when data is available
- + No costs for the manual readout, no huddle with a yearly appointment for manual meter readout person
- + Secure due to encryption, only the owner of the data knows the key required for decrypting the messages of the meters
- + Several metering providers can share a single Smart meter Gateway (water, gas, electricity, heat cost, ...)

Disadvantages for the Customers

- High initial costs: Smart meter gateway and meters with wireless interface
- Battery lifetime requires exchanging devices each 7 - 10 years in case of battery operated devices – due to security reasons “just” changing the battery is often prevented

The typical use-case contains only the transmission from the meter to the data logger, but no transmission from the data logger to the meter. Each meter sends a message in a certain period. This period always contains a randomly chosen part to avoid permanent collisions between two devices. This period varies according to the medium: for electricity the OMS recommends 7.5 minutes, for water 30 minutes and for heat cost allocators 240 minutes.

Metering media	Mandatory (billing and actuator)		Informative aspects (consumer)
	Average update interval maximum [min]	Visualization interval for energy provider [hour]	Visualization interval for consumer [min]
Electricity	7,5	1	15
Gas	30,0	1	60
Heat (district heating)	30,0	1	60
Water / Warm water	240,0	24	–
Heat cost allocators	240,0	24	–
Heat / Cost (sub metering)	240,0	24	–
Repeater*	240,0	–	–

* Limit refers to datagrams that are generated by the repeater itself. Not for repeated datagrams!
Source: OMS spec generation 4, volue 2 issue 4.2.1

The data logger forwards the (still encrypted) data to a data center or a smart meter gateway, which can also decrypt the data locally because it has received the keys of the meters through the exchange with this data center. The permitted procedure is also country-specific in Europe.

Advantages



Time saving



No personal contact needed



Autonomous



Measuring possible at any time



Smart metering: Measure and control

BUILD YOUR OWN FIRMWARE



INTRODUCTION	111
PRODUCT OVERVIEW	114
ADDED VALUES	115

INTRODUCTION

Build Your Own Firmware

With our portfolio of BYOFw modules, e.g. Ophelia-I, customers can receive a radio module in hardware-only version, meaning that the firmware for the transceiver chipset needs to be developed and flashes by customer himself.

A custom firmware:

- Can be developed using the SDK's and resources are provided by the SoC manufacturer. In case of Ophelia-I and Proteus it's either the nRF5 SDK or nRF connect SDK by Nordic Semiconductors.
- Defines the functional characteristics and specifications of the radio module
- Can be optimized to the specific application, such as allowing hostless operation

Compared to that Proteus-e, Ophelia's twin, is based on the same hardware but coming with a Bluetooth® 5.1 firmware. Proteus preinstalled firmware comes with some advantages regarding the reduction in development effort and risk for the customer. Considering the task to add a radio communication to the application, the resources required for firmware development or for module's certification are negligible. And thanks to the Wireless Connectivity SDK using the API of any wireless module from Würth Elektronik with your host IC is an easy task for developers.

If you have your custom firmware ready for either of our module hardware platforms, we can take care of the flashing and produce your custom module in the quantity you need.

 More information on page 31

	Proteus-e	Ophelia-I
Hardware platform	7 x 9 x 2 mm, nRF52805 chipset, smart antenna configuration (internal PCB + connector to external antenna)	
Firmware	Bluetooth® 5.1 firmware	No firmware
Fully certified / ready to use	✓	-
Flexibility / optimization to end application	++	+++
Module's price	€€	€
Würth Elektronik's firmware service available	✓	✓

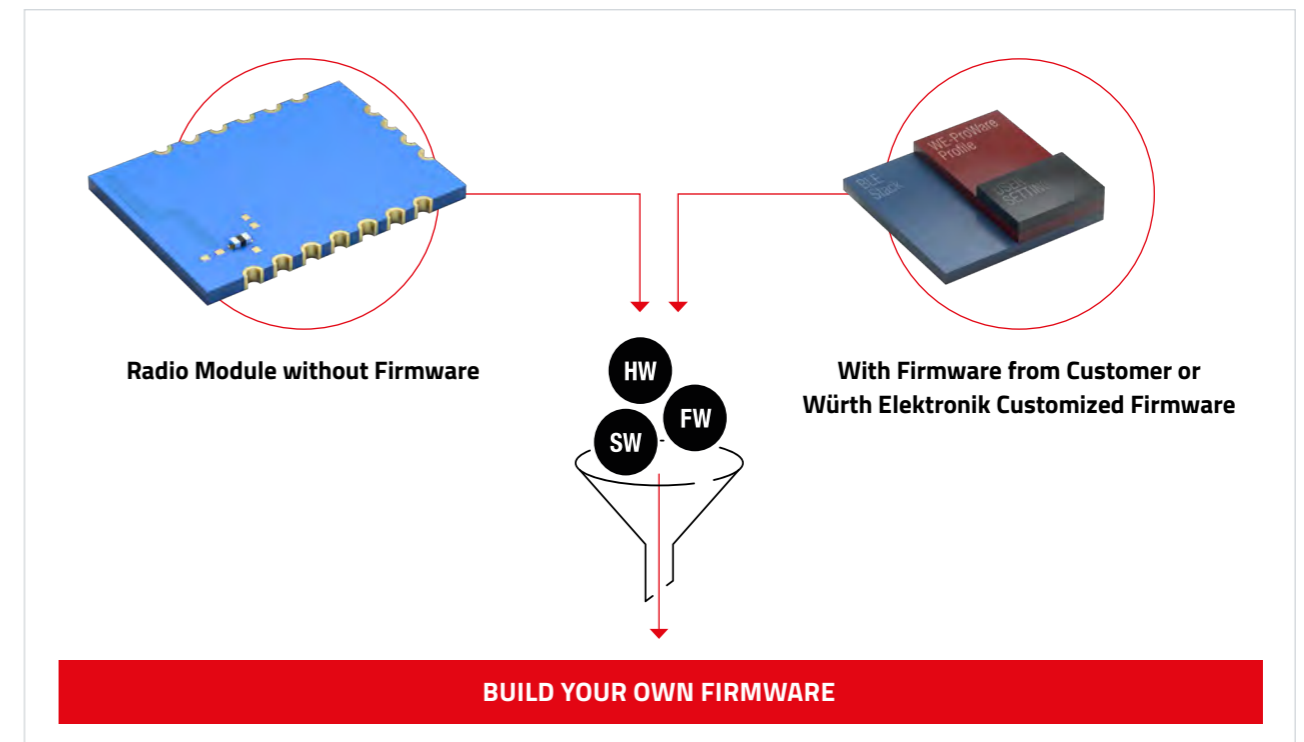

BUILD YOUR OWN FIRMWARE

With these SDKs, customers can build their firmware for the nRF52 chipset family and integrate the required functions, for example:

- Possibility to integrate device application into the module and thus save PCB space, reduce power consumption and limit the amount of parts in the circuit/the BOM.
- Define your own Bluetooth LE profiles and characteristics, make application optimized Bluetooth LE settings or even use another radio protocol such as Bluetooth MESH, Matter, Zigbee or Thread (depending on the modules HW possibilities!)
- Use UART, SPI, I²C and/or ADC to read sensor data
- Implement application-dependant and optimized behaviour and data processing
- Implement test modes for radio certification and end device testing



With that, the custom firmware can be tailored to the customer's application.



Possibilities with the Nordic SDK (nRF5 SDK, nRF Connect SDK)

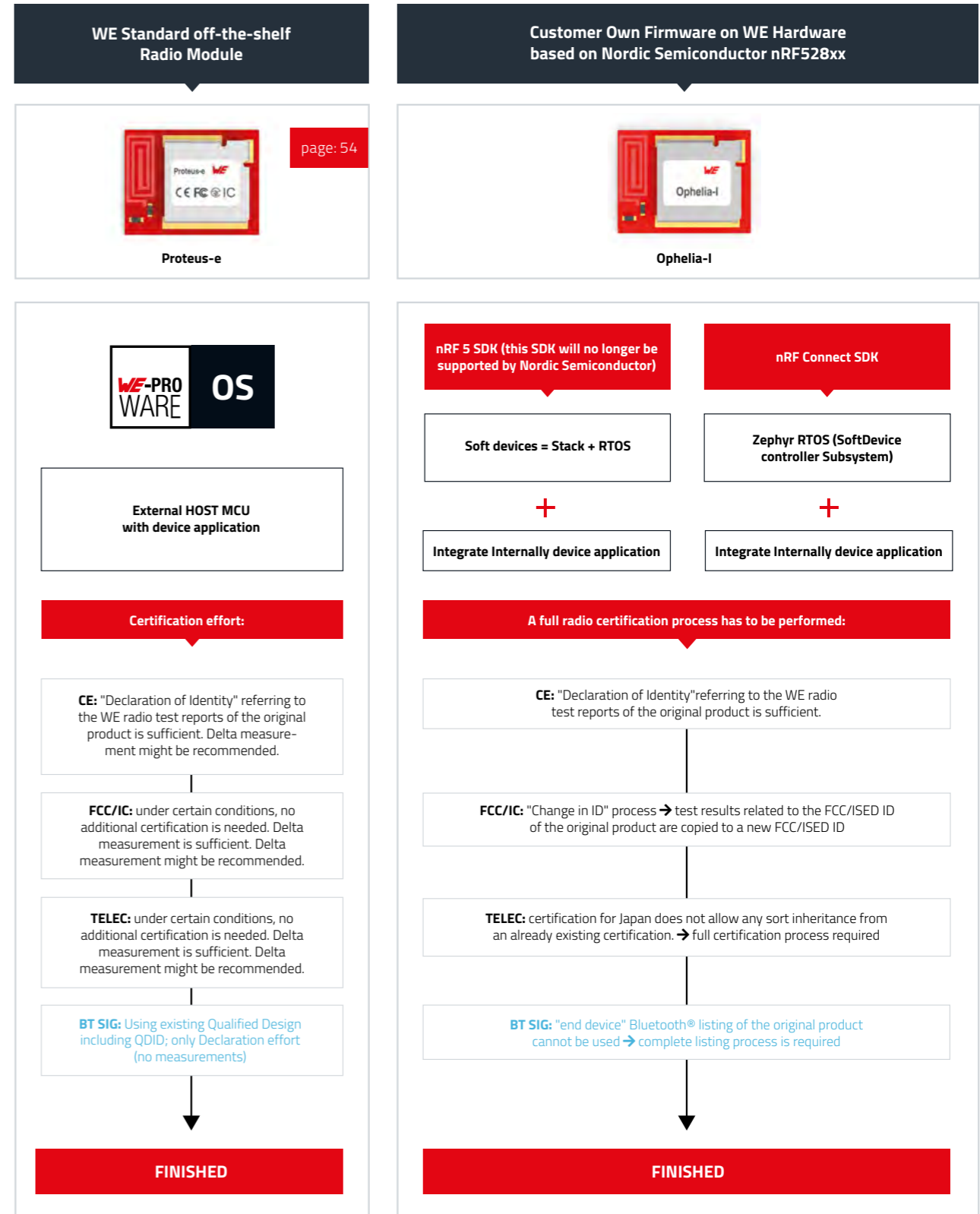

OUR INDEPENDENT: NO FIRMWARE



Ophelia-I

Hardware-only module based on Nordic nRF52805 radio chipset



Characteristics



- Hardware only: no firmware implemented on the module
- Optimization of the firmware to end application
- Nordic resources and SDK for development
- Bluetooth® Low Energy and Proprietary protocols supported
- Miniaturized design - 7 x 9 x 2 mm
- Smart antenna selection (2-in-1 Module)
- Nordic Semiconductor SoC nRF52805
- 64 MHz Arm® Cortex®-M4 processor
- 192 kB flash memory, 24 kB RAM
- 10 configurable GPIOs
- 0.3 µA sleep current (system off mode)
- Cost effective solution
- Ready for CE/RED, FCC, IC and TELEC certifications
- Same hardware platform available as Bluetooth® 5.1 module (Proteus-e)
- Firmware service by Würth Elektronik available

we-online.com/Ophelia-I

STEP BY STEP

How to develop a Firmware on Ophelia-I

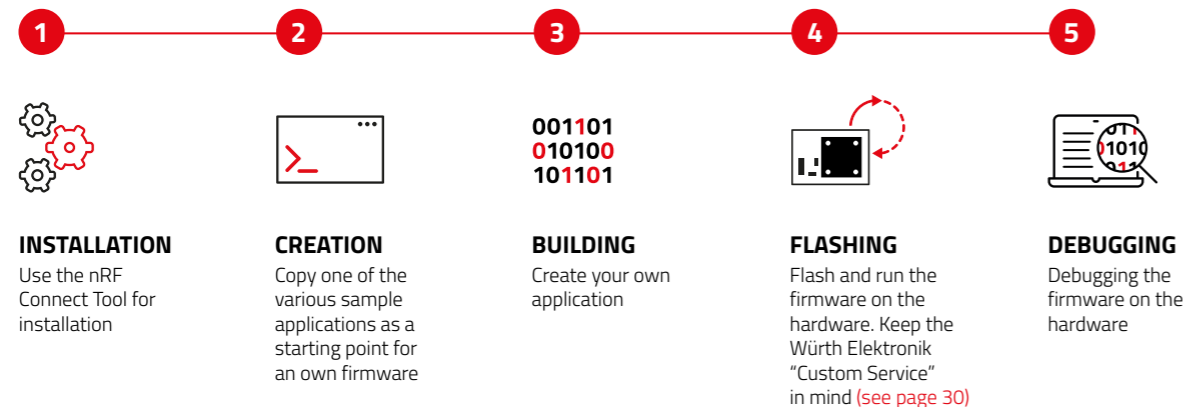

ADDED VALUES

Development Tools

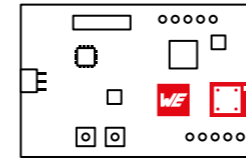

Eval Boards

- Easy testing
- Rapid prototyping
- FTDI integrated (UART to USB)
- Pins available on header
- Current measurement



we-online.com/EVAL-BYOF

AppNotes



nRF Connect – developing a custom FW

we-online.com/ANR030



POSITIONING & TIMING GNSS



INTRODUCTION	117
PRODUCT OVERVIEW	118
ADDED VALUES	120

INTRODUCTION

GNSS

GNSS (Global Navigation Satellite System) is a system, which provides positioning and time synchronization capabilities to an unlimited number of users worldwide. The system is based on signals from the following four satellite constellations.

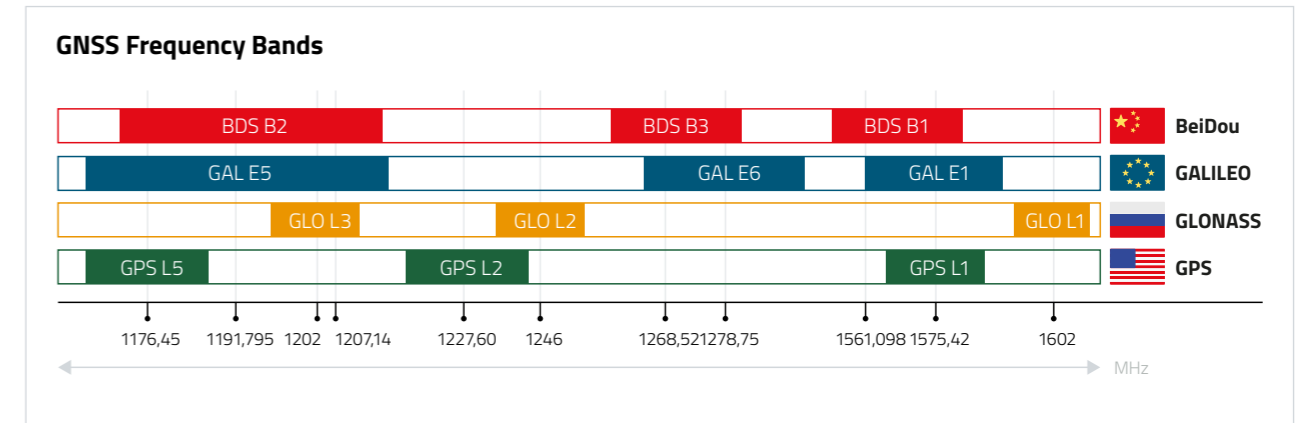

Signals from the different constellations can coexist on the same frequency bands. Each GNSS provides different signals and services over these frequency bands with different access policies. For example, open signals on the L1 frequency band are mostly used for civil commercial applications.

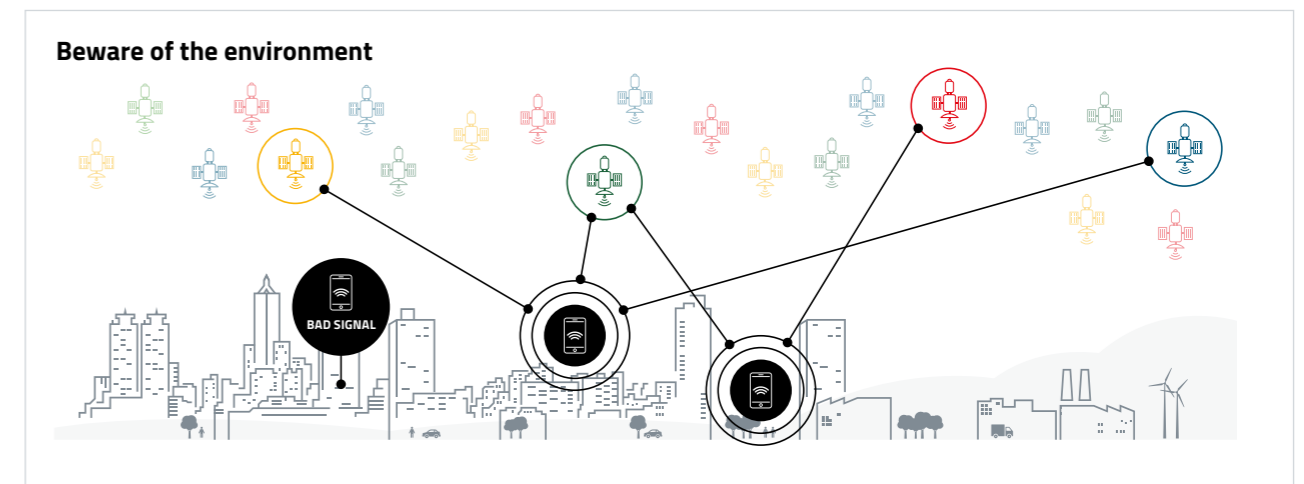

The application environment of the receiver plays an important role in the navigation, with best performance obtained in open-sky conditions. Presence of obstacles and multipath effects define a GNSS challenging environment (e.g. urban canyons), where the receiver has to work with fewer and weaker signals. This makes multi-GNSS even more decisive to the receiver's performance, since more satellites are available for tracking in a given area.

Areas of Application

- ✓ Tracking and navigation devices
- ✓ Container localization
- ✓ Fleet management
- ✓ Location support for rescue
- ✓ Cartography
- ✓ Autonomous agricultural machines
- ✓ Geotagging for digital cameras
- ✓ Animal tracking
- ✓ Time reference for worldwide events/machine synchronization

Cellular

Bluetooth®

Wi-Fi

Proprietary

Combined

Mesh

Wireless M-Bus

Build Your Own Firmware

GNSS

Sensors

PRODUCT OVERVIEW

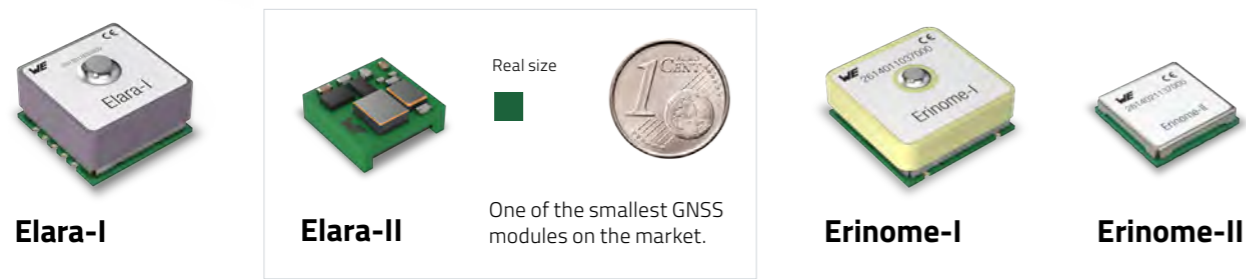

Characteristics

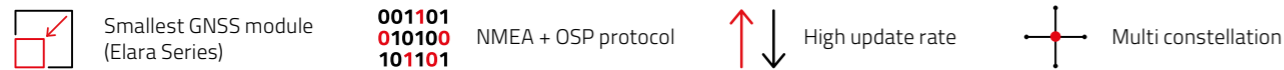

- Integrated / external antenna variants
- Multi-GNSS (+SBAS and QZSS) supported
- Unbeaten accuracy and time to first fix performances
- High update rate (up to 10 Hz)
- Low power modes
- UART, I²C and SPI interface
- EDA libraries
- Wireless Evaluation Board

we-online.com/GNSS

Differences

	Base Line		Advanced Line	
	Elara-I	Elara-II	Erinome-I	Erinome-II
Order Code	2613011037000	2613021137000	2614011037000	2614021137000
Onboard antenna	✓	-	✓	-
Dimensions [mm]	10 x 10 x 5.9	4.1 x 4.1 x 2.2	18 x 18 x 6.4	7 x 7 x 1.6
GNSS constellations supported	GPS, GLONASS, +QZSS, SBAS	GPS, GLONASS, +QZSS, SBAS	GPS, GLONASS, Galileo, Beidou, +QZSS, SBAS	GPS, GLONASS, Galileo, Beidou, +QZSS, SBAS
Accuracy [m]	1.5	1.5	1.5	1.5
Time To First Fix (cold start) [sec]	28	28	28	28
Max update rate [Hz]	5	5	10	10
Number of concurrent GNSS [max]	2	2	3	3
Supply voltage [V]	1.8	1.8	3.3	1.8
Interfaces	UART, I ² C, SPI	UART, I ² C, SPI	UART, I ² C, SPI	UART, I ² C, SPI
GNSS chipset	SiRFstar V B01	SiRFstar V B01	SiRFstar V B02	SiRFstar V B02
High sensitivity	✓	✓	✓	✓
Integrated LNS, SAW filter, TCXO, RTC	✓	✓	✓	✓

- External Antenna Halimede-I**
- Active GNSS antenna
 - Power supply: 3 - 5 V
 - SMA connector and 3 meters cable
 - GPS, GLONASS, Galileo, Beidou
 - IP66 - water resistant against powerful jets
 - CE declaration
 - Suitable for challenging GNSS environment

- External Antenna WE-MCA**
- SMT multilayer chip antenna
 - Extremely low profile
 - Omni-directional radiation pattern
 - Excellent size to performance ratio
 - Smallest form factor in the industry
 - Less ground clearance
 - Operating temperature: -40 °C to +85 °C

OUR FLEXIBLE LOCATOR: GNSS EVALUATION



Evaluation Kit

For a better evaluation of our GNSS modules in the outdoor environment we have developed a special Evaluation Kit with our 2.4 GHz module Thyone-I.

Characteristics



Wireless Operation of the GNSS Evaluation Board:

- ✓ The board provides several power options (USB, battery, external supply).
- ✓ Allows testing the GNSS module without cable connection between its evaluation board and the host PC.
- ✓ An adapted version of Thyone-I RF module is implemented. GNSS module is talking directly (without further μ C) to Thyone-I.
- ✓ Messages coming from the GNSS module are delivered via UART to the Thyone-I module on the evaluation board.
- ✓ The Thyone-I module on the evaluation board broadcasts all arriving messages.
- ✓ Other Thyone-I units (e.g. our USB stick) in the area receive the messages.
- ✓ If these Thyone-I units are connected to a host PC, WENSS allows communicating with the GNSS module.
- ✓ Eval Board can be placed outside for evaluating in real conditions and the host is located indoor.

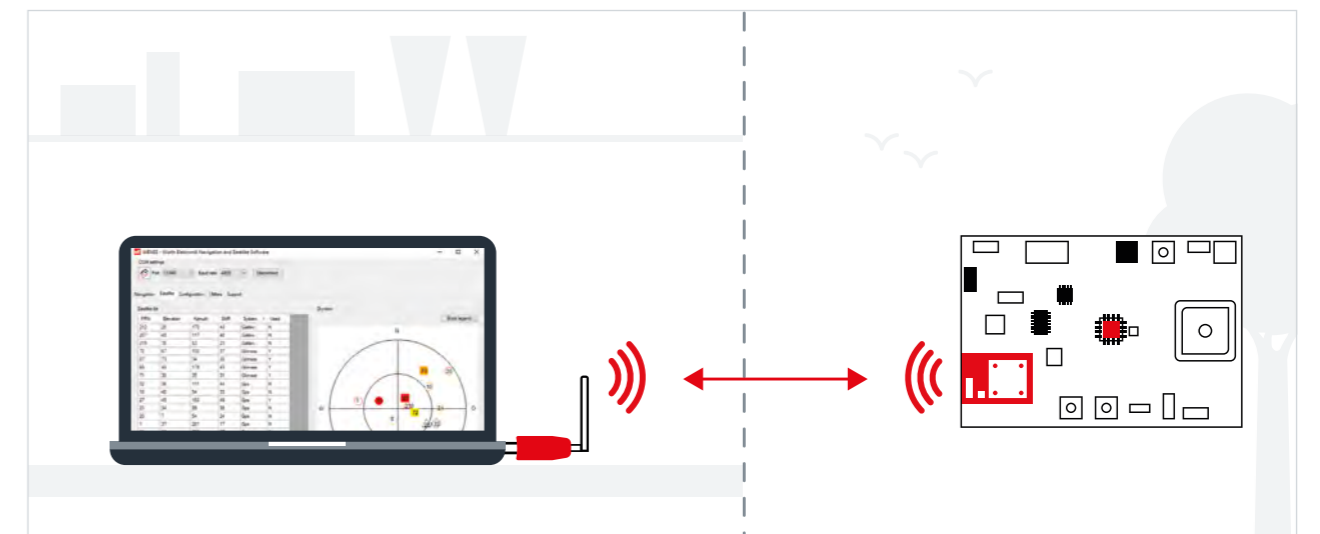

ADDED VALUES

Development Tools

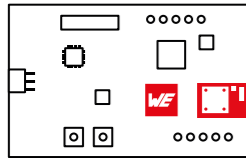

Eval Boards

- Easy testing
- Rapid prototyping
- FTDI integrated (UART to USB)
- Pins available on header
- Current measurement
- Evaluating different antenna variants (Elara-II, Erinome-II)
- Putting into operation



we-online.com/EVAL-GNSS



More information on page 150

AppNotes

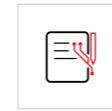

ANR017 GNSS Antenna Selection

we-online.com/ANR017



ANR018 GNSS I²C Communication

we-online.com/ANR018



Webinar:

Basics of GNSS positioning and receivers' technology

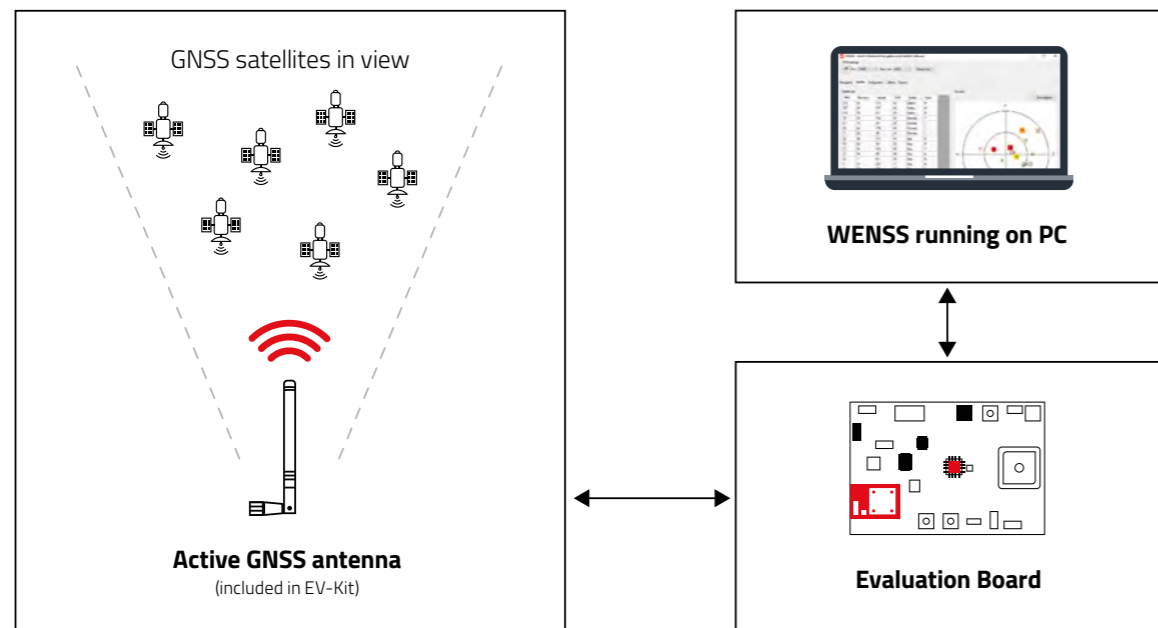

WENSS: Navigation and Satellite Software

- Proprietary, free-of-charge and user friendly PC tool
- Quick start
- Communication with the GNSS module from a host PC
- Testing module functionalities and features
- Understanding software protocols



Download: WENSS

we-online.com/WENSS

DISCOVER THE WORLD OF SENSORS



INTRODUCTION & FUNDAMENTALS	123
TEMPERATURE	130
HUMIDITY & TEMPERATURE	132
ACCELERATION	134

ABSOLUTE PRESSURE	136
DIFFERENTIAL PRESSURE	138
ADDED VALUES	144

INTRODUCTION

What is a sensor component?

A system to measure a physical dimension and to translate into an electrical value! Sensors are basically analog with infinite resolution, but data to and from the cloud is transferred digital. Analog sensor values must therefore be digitized. Conversion can be done in external AD converters when using an analog sensor cell or the conversion can be all done internally, within the sensor system, when using a MEMS sensor. Digital MEMS sensors help to save time, processor bandwidth and board space.

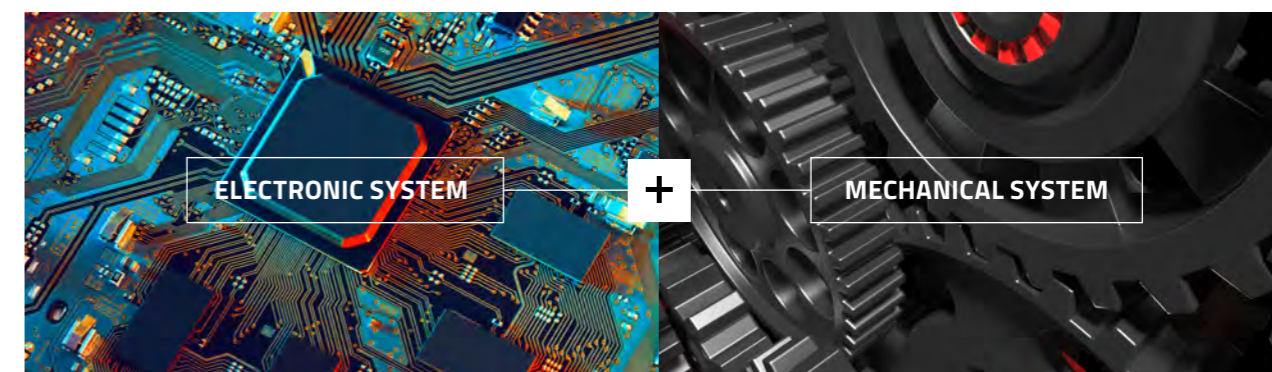

MEMS sensors

In a microcontroller the typical semiconductor can only control current and voltages. In a Micro-Electro-Mechanical System (MEMS), additional mechanical structures are used. This means that three-dimensional structures are usually added to the starting material silicon by etching processes. This allows the design of membranes (WSEN-PADS) or movable finger structures (WSEN-ITDS).

Combined sensors

Some sensors actually consist of multiple sensor elements in the same housing like the combined Humidity and Temperature sensor WSEN-HIDS or the combined Pressure and Temperature sensor WSEN-PADS.

This has advantages when:

- Space is at a premium (Diverse sensors in one housing require less space than single sensors)
- Power supply is limited (Multifunction sensors typically require less power than multiple single sensors)
- Price matters (a single, slightly larger, package is generally less expensive than several smaller ones.)
- Measurement accuracy must be improved (Short cable runs between the contained sensors are more easily shielded within a package than connections made to the outside.)
- Additional data can be calculated (in some cases, additional information can be calculated from measured values of combination sensors)

Additional Advantages of integrated sensors

- ✓ Surface mounted device (SMD)
- ✓ Silicon based
- ✓ Fully calibrated
- ✓ Integrated DSP
- ✓ Digital interface (I²C, SPI)

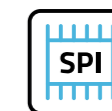
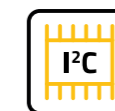

Longlife availability (10 years)

To avoid additional wiring in end device it is more and more common to replace the cables with wireless connectivity solutions like radio modules from Würth Elektronik. This requires especially sensors to be very energy-efficient, i.e. offering a very low power consumption. With that achievement a wireless sensor network can be operated on battery by ten years and more.

Cellular

Bluetooth®

Wi-Fi

Proprietary

Combined

Mesh

Wireless M-Bus

Build Your Own Firmware

GNSS

Sensors

INTRODUCTION

Functionality of a MEMS Pressure Sensor

A MEMS pressure sensor is based on a thin membrane. Typically two principles are used. The first principle is based on a change in resistance of integrated resistors caused by the deflection of the membrane. The second principle is based on a capacitive effect: a counter electrode is located below the membrane and based on the deflection of the membrane, the distance and thus the capacitance is changed.

A MEMS pressure sensor is more expensive in comparison to a MEMS Acceleration Sensor due to:

- Direct contact to the environment
- Packaging is more complex

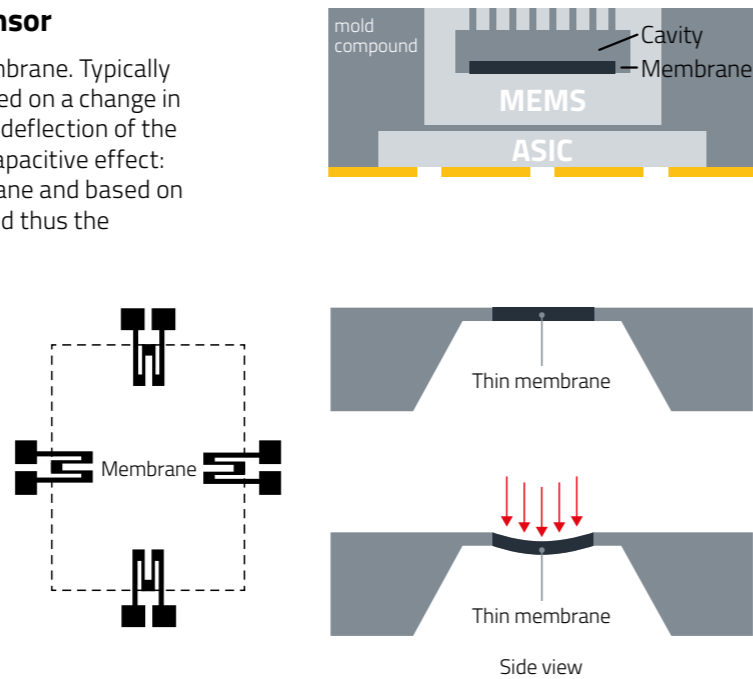

Source: <https://www.radiolocman.com/review/article.html?id=148185>

Functionality of a MEMS Acceleration Sensor

The sensor is a MEMS based capacitive acceleration sensor with an integrated ASIC. The acceleration sensors production approach is the creation of finger structures. One side is fixed, the other side is flexibly suspended. The sensor measures the acceleration or vibration through MEMS capacitive sensing principle. If this system gets accelerated, the distance changes between the fixed and movable structure. This change in distance causes a change in the electrical capacitance (capacitor principle), which could be measured electrically and serves as a reference value for acceleration.

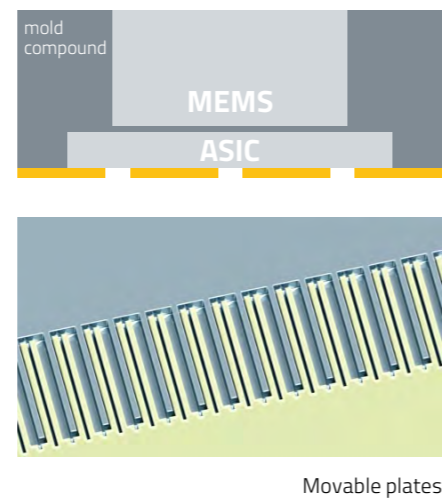

Movable plates

Which pressure sensor do I need?

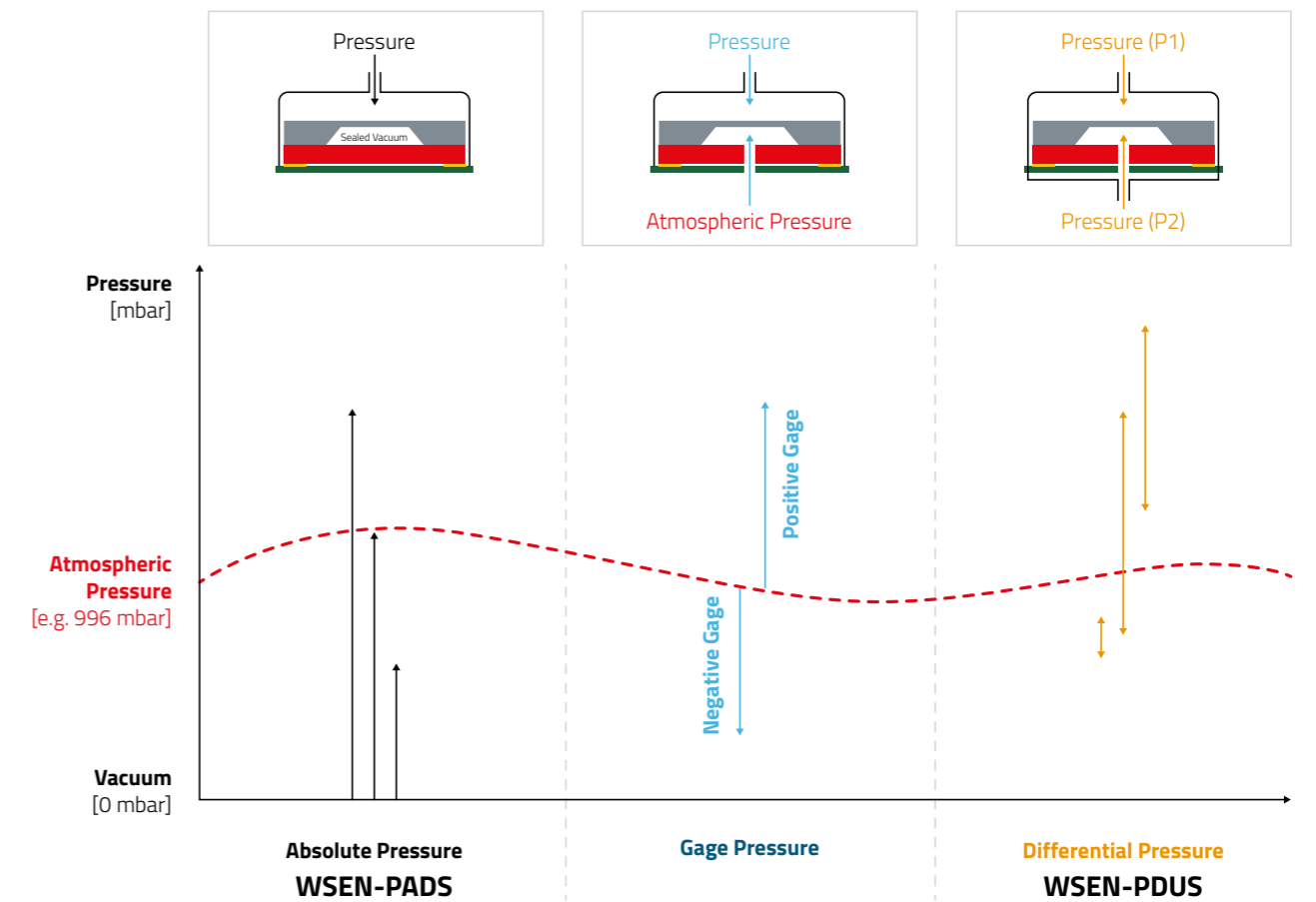

MEMS capacitive sensing circuit

Simple explanation - Capacitance is converted to Voltage.

- Fixed and movable plates
- Capacitance in pF
- Capacitors in parallel
- $\Delta C \sim V_{out}$

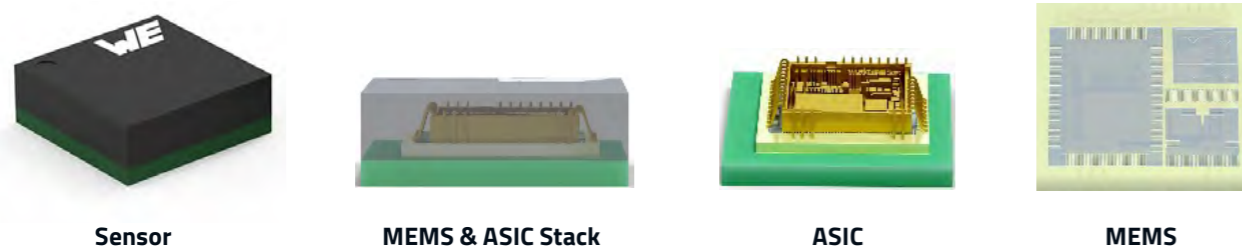
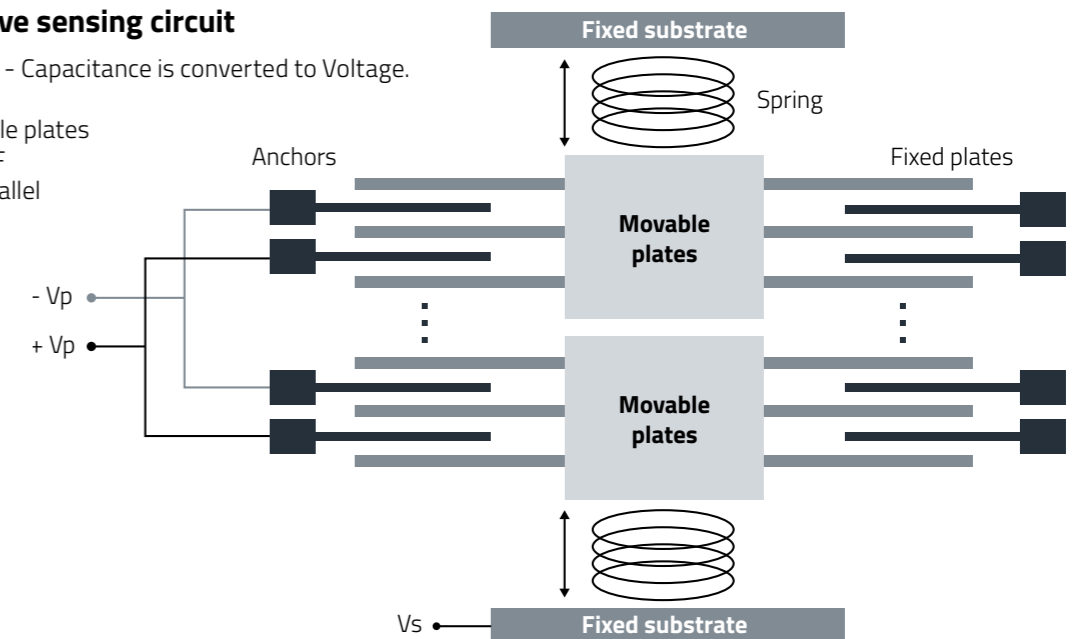

INTRODUCTION

Block Diagram

The best way to explain the function of MEMS sensors is a block diagram. The biggest difference to conventional (analog) sensors is that not only the actual measuring cell but also the complete processing can be integrated to achieve a very small sensor system. This eliminates any analog data processing on application level and a digital signal can be used directly by a microcontroller. Since a complete system is combined in one component, a complete factory calibration is also possible.

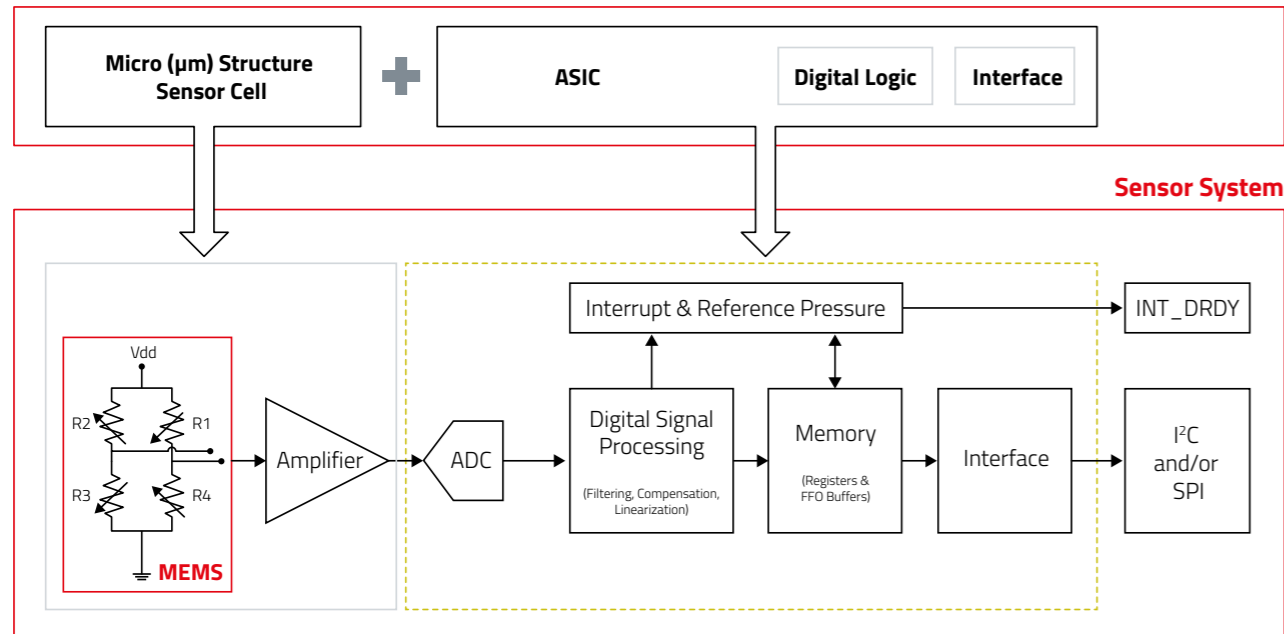

Micro-Electro-Mechanical System - Unit

- Bulk- or surface micromachining to create mechanical structures
- Very small dimensions possible
- Able to detect very small changes in physical dimension

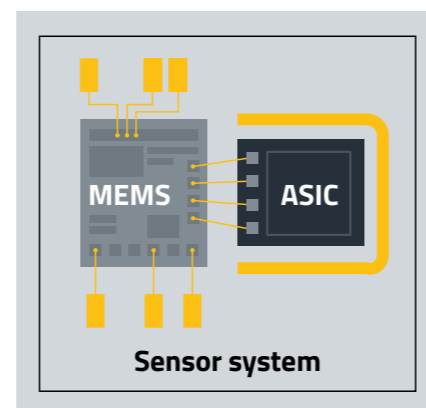

Application-Specific-Integrated Circuit - Unit

Analog front end:

- Amplifying the signal
- Multiplexing in case of different sensor elements
- Conversion from analog to digital value

Digital logic:

- Filtering
- Compensation and linearization
- Registers and buffering

Interfaces:

- I²C – digital interface
- Interrupt for special scenarios

Comparison Analog vs Digital sensor

	Analog sensor	Digital sensor
Dimension	Mostly several parts needed, bigger formfactor	All-in-one, smaller formfactor
Costs	Several components like sensor, external resistors, stable voltage supply, ADC are needed	MEMS sensor covers the whole sensor system
Calibration	Field/system calibration needed (at multiple temperatures)	Off-the-shelf calibrated
Accuracy	System accuracy = sensor element + measuring circuitry	Sensor accuracy = System accuracy
Measuring	Mostly non-linear	Fully compensated and calibrated
Power Consumption	Voltage divider constantly drains power	Very low power, sleep mode between active sense cycles
Data Quality	Contact and load resistance as well as the absolute voltage supply level will have an influence on the accuracy. Additional inaccuracy based on the ADC has to be considered.	Stable output signal (digital value), additional possibilities to verify correct data transmission like parity or CRC. Also sensor status information can be sent.
Integration	External circuitry	Simple I/O pins with direct values from sensor

Different Modes for different Needs

Typically the mode selection is a tradeoff between current consumption and accuracy/noise.

- High Performance mode with highest data rate
- Normal mode as a perfect compromise
- Low power mode with lowest power consumption

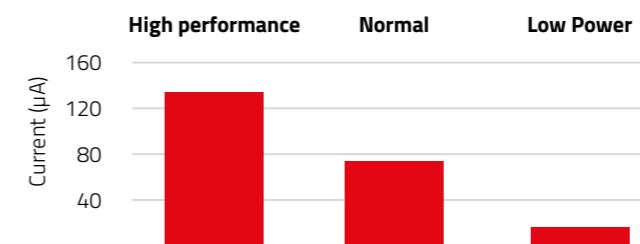

SENSOR GUIDE

How to find the suiting product?

This Sensor Guide will help you to find a solution for your application! Answer the following questions, as far as you to be able to take a decision.



If there is any need of support: Contact us!
wireless-sales@we-online.com

1. Sensing medium	2. Interface	3. Environment	4. Accuracy Requirements	5. Characteristics requirements	6. Use Case / Application
<p>Which medium do you want to measure?</p> <p><input type="checkbox"/> Temperature</p> <p><input type="checkbox"/> Humidity</p> <p><input type="checkbox"/> Pressure absolute</p> <p><input type="checkbox"/> Pressure differential</p> <p><input type="checkbox"/> Acceleration</p> <p><input type="checkbox"/> other: _____</p>	<p>Which interface do you want to use?</p> <p><input type="checkbox"/> I2C</p> <p><input type="checkbox"/> SPI</p> <p><input type="checkbox"/> Analog</p> <p><input type="checkbox"/> other: _____</p>	<p>In which environment will your application be used?</p> <p><input type="checkbox"/> Indoor</p> <p><input type="checkbox"/> Outdoor</p> <p><input type="checkbox"/> Industrial</p> <p><input type="checkbox"/> Home Automation</p> <p><input type="checkbox"/> other: _____</p>	<p>What are the key requirements for the accuracy of the sensor?</p> <p><input type="checkbox"/> High accuracy: _____</p> <p><input type="checkbox"/> Medium accuracy: _____</p> <p><input type="checkbox"/> Accuracy doesn't matter</p> <p><input type="checkbox"/> other: _____</p>	<p>What are the additional requirements for the characteristics of the sensor?</p> <p><input type="checkbox"/> Energy consumption: _____</p> <p><input type="checkbox"/> Operating supply voltage: _____</p> <p><input type="checkbox"/> Output data rate: _____</p> <p><input type="checkbox"/> Size: _____</p> <p><input type="checkbox"/> Media resistance: _____</p> <p><input type="checkbox"/> other: _____</p>	<p>What is the use case / the application of the sensor element / sensor system?</p> <p><input type="checkbox"/> Sensor network</p> <p><input type="checkbox"/> Environment measuring</p> <p><input type="checkbox"/> Process control / automation</p> <p><input type="checkbox"/> Redundancy</p> <p><input type="checkbox"/> Event triggering / decision support</p> <p><input type="checkbox"/> other: _____</p>

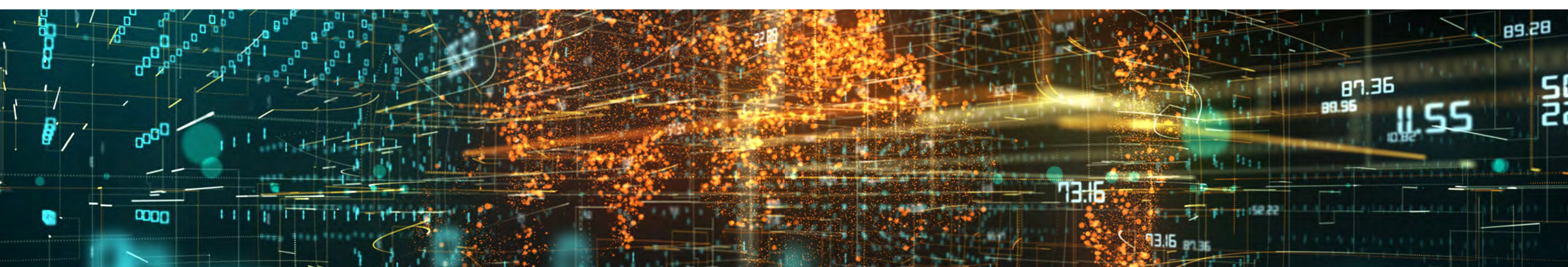

PRODUCTS



WSEN-TIDS Temperature Sensor IC

Product Features

- Cut&Tape: No MOQ and small packing units
- Long term availability
- Small size
- Low Power Consumption

- Silicon based digital temperature sensor
- High accuracy (up to ± 0.25 °C typ.)
- Fully calibrated 16 bit temperature output
- Low current consumption of 1.75 μ A typ
- Size: 2 x 2 x 0.55 mm
- Selectable output data rate up to 200 Hz
- I²C digital communication interface
- Programmable temperature threshold and interrupt
- 2 selectable I²C addresses

Order Code	T _{RANGE min} (°C)	T _{RANGE max} (°C)	RES _T (bits)	ODR _{min} (Hz)	ODR _{max} (Hz)	V _{DD min} (V)	V _{DD max} (V)
2521020222501	-40	125	16	25	200	1.5	3.6

T_{RANGE}: Measurement range [min.]; RES_T: Resolution [typ.]; ODR_{min}: Output data rate [min.]; ODR_{max}: Output data rate [max.]; V_{DD min}: Operating supply voltage [min.]; V_{DD max}: Operating supply voltage [max.]

Block Diagram

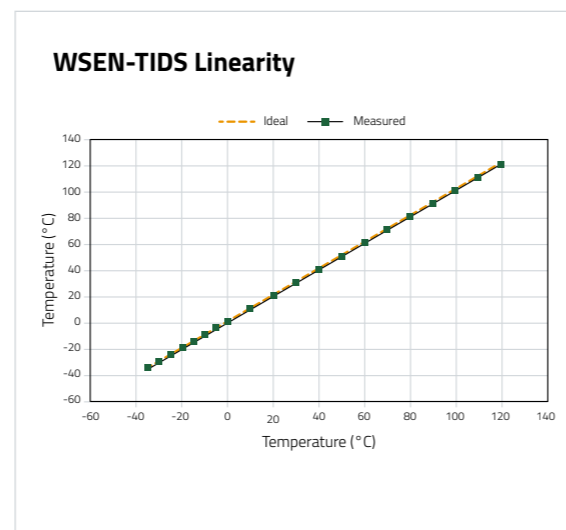
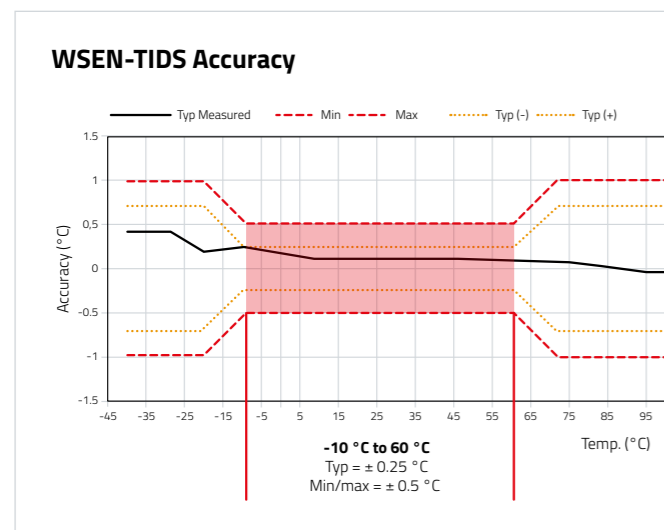
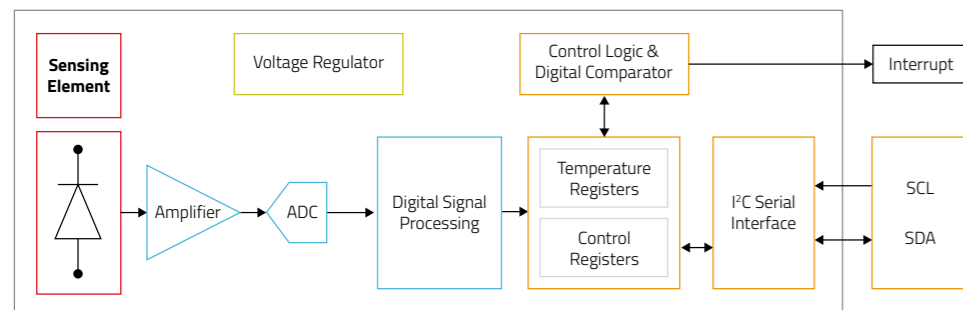

Comparison of sensor types

	Thermocouple	RTD	Thermistor	WSEN-TIDS MEMS
Measurement range	-250 °C to 2500 °C	-250 °C to 700 °C	-100 °C to 250 °C	-55 °C to 150 °C
Accuracy	Average (require CJC)	Highest	Average	High
Sensitivity	Low-average	Average	High	High
Linearity	Average	Good	Low	Highest
Peripheral Circuits/Calibration	CJC; Amplifier; Scaling	Resistance correction; Scaling	Scaling	No
Footprint	Large	Medium	Small	Smallest
Price	Moderate	Very high	Low	Low

CJC= Cold Junction Compensation → Reference Calibration

Mounting examples based on application

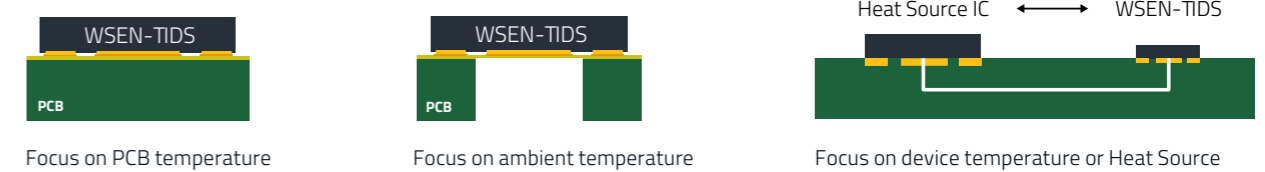

Power saving through interrupt output

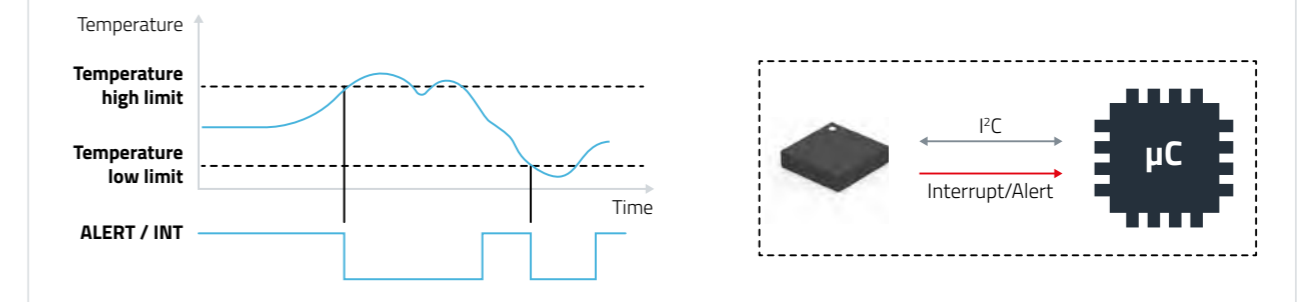

we-online.com/WSEN-TIDS

Webinar:
Digital silicon-based temperature sensors for industrial applications

PRODUCTS



WSEN-HIDS Humidity Sensor with integrated Temperature Sensor

Product Features

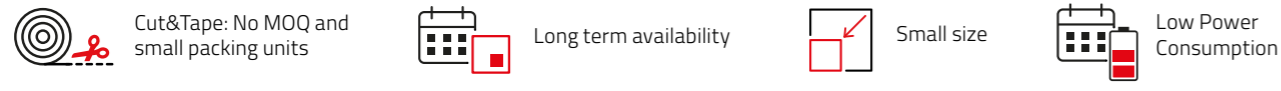

- MEMS based capacitive sensing principle
- Relative humidity range 0% to 100%
- Embedded analog to digital converter
- Fully calibrated 16 bit humidity and temperature output
- Size: 2 x 2 x 0.9 mm
- I²C and SPI communication interface
- Selectable output data rate up to 12.5 Hz
- Operating temperature range: -40 °C to 120 °C

Order Code	H _{RANGE min} (% rH)	H _{RANGE max} (% rH)	RES _r (bits)	ODR _{min} (Hz)	ODR _{max} (Hz)	V _{DD min} (V)	V _{DD max} (V)
2525020210001	0	100	16	1	12.5	1.7	3.6

H_{RANGE min}: Measurement range [min.]; H_{RANGE max}: Measurement range [max.]; RES_r: Resolution [typ.]; ODR_{min}: Output data rate [min.]; ODR_{max}: Output data rate [max.]; V_{DD min}: Operating supply voltage [min.]; V_{DD max}: Operating supply voltage [max.]

Block Diagram

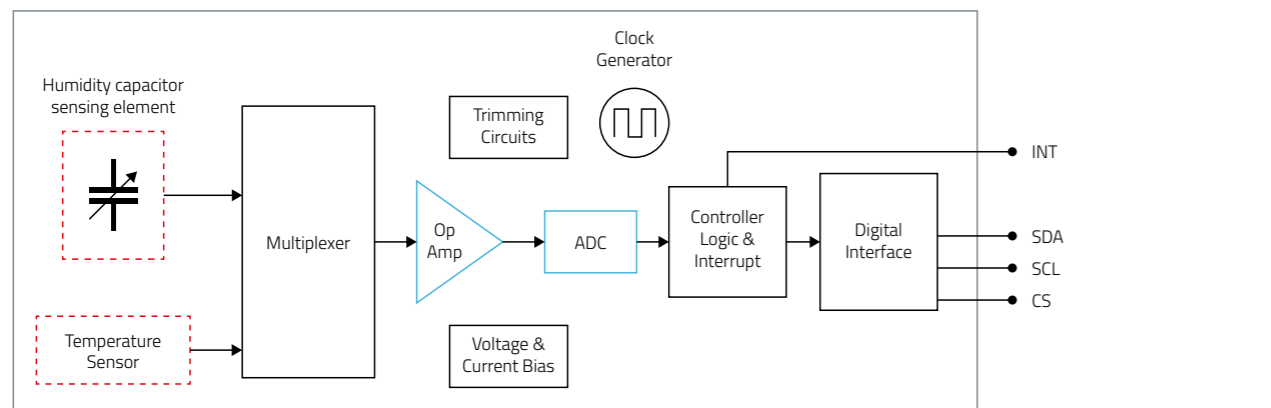

Working Principle

- Capacitive Sensing technology
- The humidity sensor is a small capacitor consisting of a hygroscopic dielectric material placed between a pair of electrodes. The change in the humidity in atmosphere will affect the dielectric constant which results in change in the capacitance represents the moisture % in atmosphere
- Integrated heater to remove condensed water on sensor surface

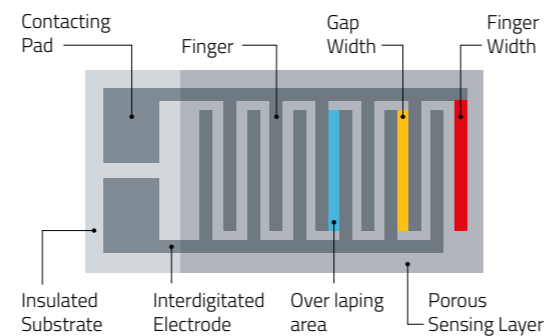

$$Capacitance = \epsilon_r \epsilon_0 \frac{A}{d} \text{ (Farad)}$$



Accuracy

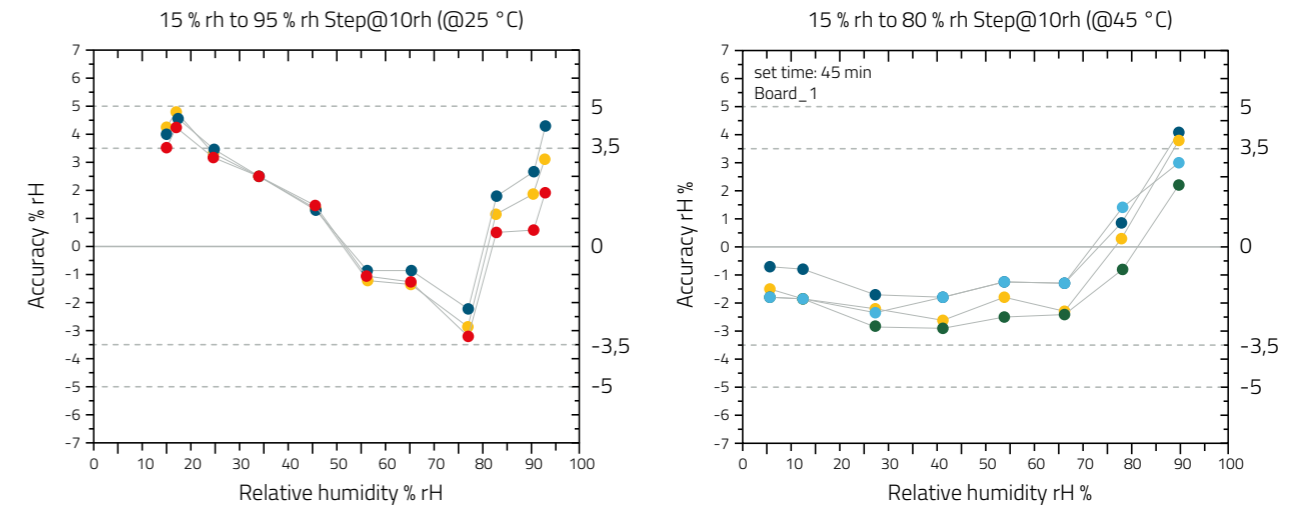

Temperature sensor accuracy

Temperature Sensor	Measurement Range	Test Condition	Accuracy
Measurement Range	-40 °C to 120 °C	From 15 °C to 40 °C	+/- 0.5 °C
		From 0 °C to 60 °C	+/- 1 °C

PCB layout recommendations

The combined Humidity and Temperature Sensor is high is very sensitive to the environment. Therefore it is recommended to follow the design guidelines strictly. Details can be found in our Application Note.

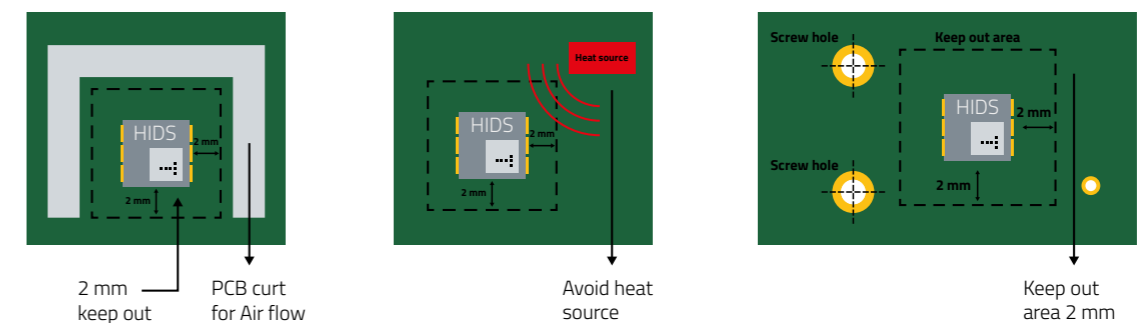

PRODUCTS

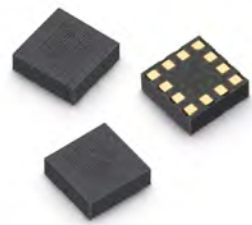

WSEN-ITDS 3 Axis Acceleration Sensor

Product Features

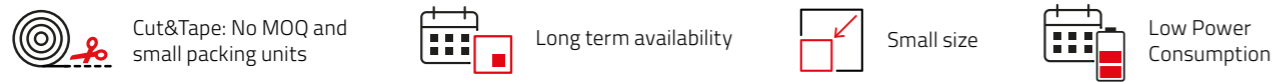

- MEMS based capacitive sensing principle
- 14 bit output resolution
- Full scale $\pm 2\text{ g}$, $\pm 4\text{ g}$, $\pm 8\text{ g}$, $\pm 16\text{ g}$
- Bandwidth up to 1600 Hz
- 32 level FIFO buffer
- Size: 2 x 2 x 0.7 mm
- Embedded temperature sensor
- I²C digital communication interface
- Temperature range: -40 °C up to +85 °C

Order Code	a_{RANGE}	RES _a (bits)	ODR _{max} (Hz)	f _{BW} (Hz)	V _{DD min} (V)	V _{DD max} (V)
2533020201601	$\pm 2 / \pm 4 / \pm 8 / \pm 16\text{ g}$	14	1600	400	1.7	3.6

a_{RANGE} : Acceleration range [typ.]; RES_a: Resolution [max.]; ODR_{max}: Output data rate [max.]; f_{BW}: Bandwidth [max.]; V_{DD min}: Operating supply voltage [min.]; V_{DD max}: Operating supply voltage [max.]

Block Diagram

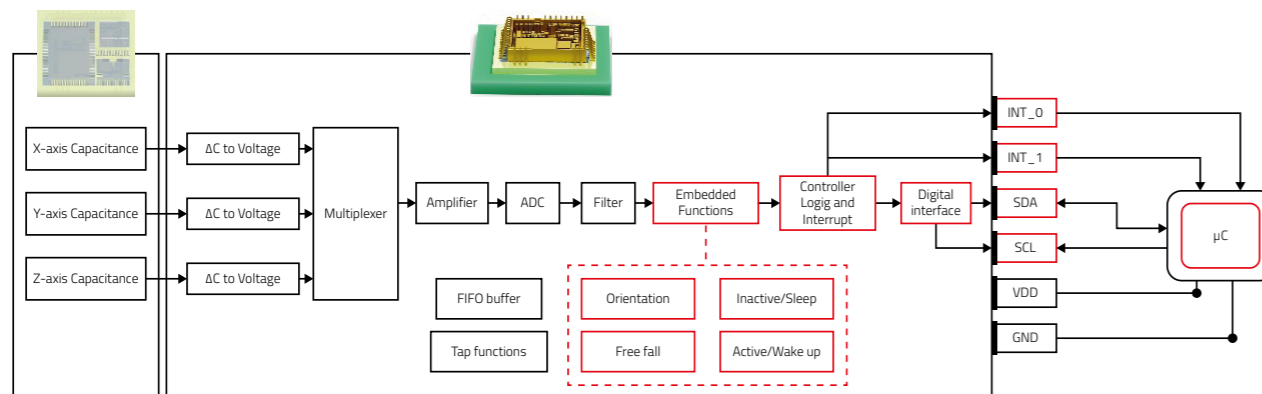

Automatic operating mode change for low battery power application

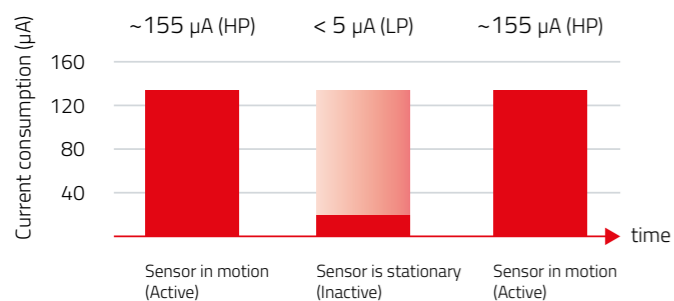

Embedded Functions

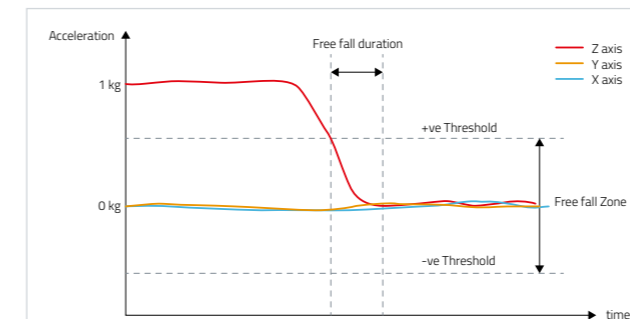

Free fall

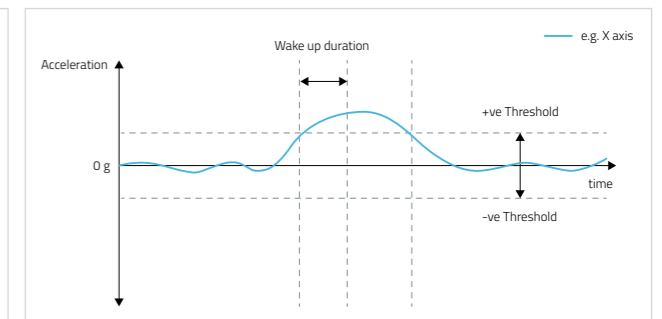

Sleep and wake up

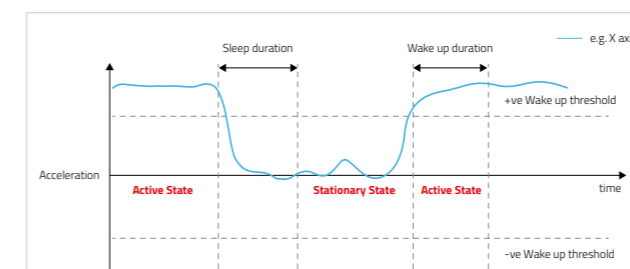

Stationary/Active

Application: Low Vibration detection – Bandwidth as a key factor

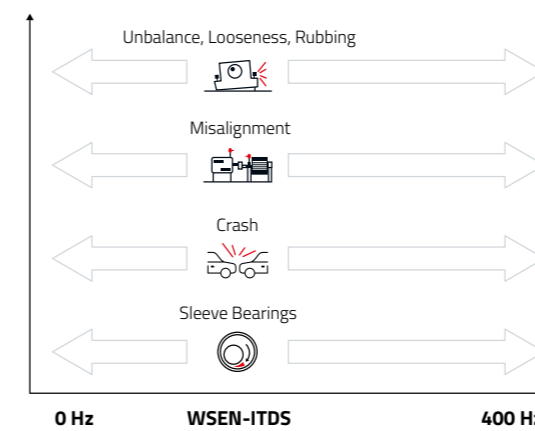

Bandwidth cutoff frequency at 400 Hz

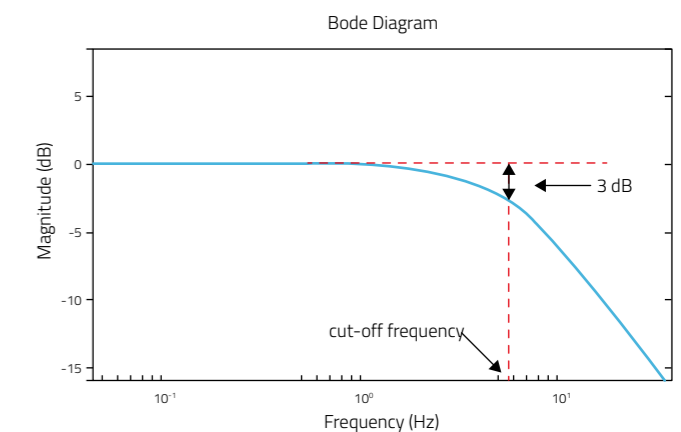

we-online.com/WSEN-ITDS



Webinar:

Accelerate your IoT development project with our MEMS 3-axis sensor





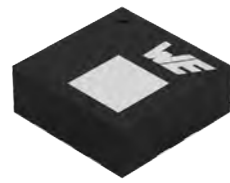

PRODUCTS

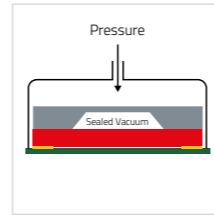

WSEN-PADS Absolute Pressure Sensor



Product Features

-  Cut&Tape: No MOQ and small packing units
-  Long term availability
-  Small size
-  Low Power Consumption

- MEMS based piezo-resistive sensing principle
 - 24 bit pressure output resolution
 - Selectable output data rate up to 200 Hz
 - 128 level FIFO buffer
 - Low current consumption of 0.9 µA typ.
 - Size: 2 x 2 x 0.8 mm
- Embedded temperature sensor
 - I²C digital communication interface
 - Application specific interrupt event setting
 - Temperature range: -40 °C up to +85 °C (16-bits)
 - ±1 mbar absolute accuracy

Order Code	P _{RANGE min} (kPa)	P _{RANGE max} (kPa)	RES _p (bits)	ODR _{min} (Hz)	ODR _{max} (Hz)	V _{DD min} (V)	V _{DD max} (V)
2511020213301	26	126	24	1	200	1.7	3.6

P_{RANGE min}: Measurement range [min.]; P_{RANGE max}: Measurement range [max.]; RES_p: Resolution (ADC) [typ.]; ODR_{min}: Output data rate [min.]; ODR_{max}: Output data rate [max.]; V_{DD min}: Operating supply voltage [min.]; V_{DD max}: Operating supply voltage [max.]

Block Diagram

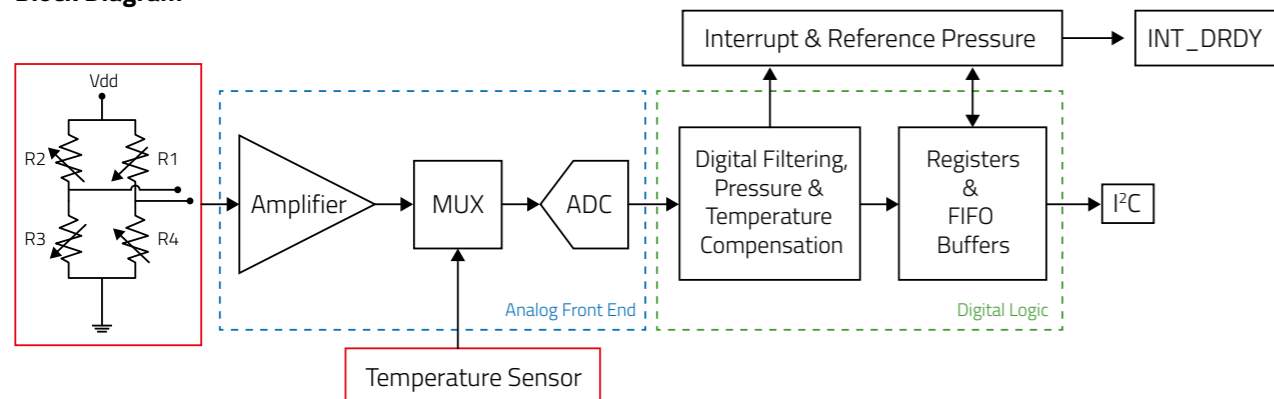

Additional Advantages of the integrated sensor

- Fully molded package
- Increased robustness
- Contamination risk reduced
- Improved moisture and dust resistance
- Multiple vent holes

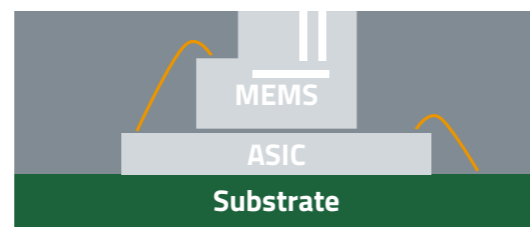

Is WSEN-PADS suitable for my application?

This absolute pressure sensor is housed in a small package suitable for surface mounting on a printed circuit board (PCB). That's why the WSEN-PADS is also known as a board-level sensor. This makes it ideal for consumer applications where the pressure on the PCB can be measured, e.g. B. in an altimeter or a sports watch, but this sensor is not suitable for the high temperatures of liquids or gases. It is also not adequately protected against dust, moisture or the chemicals commonly used for cleaning in industry. Industrial sensors are usually robustly packaged. They are usually made of corrosion-resistant material such as stainless steel and are threaded so they can be attached to pipes and storage tanks.

WSEN-PADS for Altitude measurements

An altimeter is an instrument that measures the height/altitude above a fixed level. Almost linear co-relation between the atmospheric pressure and the altitude enables the use of absolute pressure sensors as Altimeters. With the Built-in features like filters, offset calibration, temperature compensation etc., WSEN-PADS acts as a precise Altimeters and could be even used for indoor applications like, building height and floor detection.

Relationship between atmospheric pressure and altitude

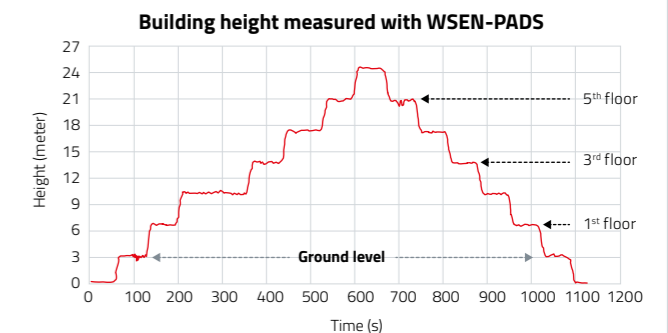
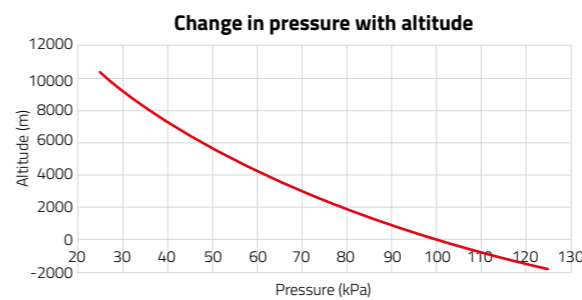

$$h = 44330.77 \times \left[1 - \left(\frac{P}{P_0} \right)^{0.256} \right]$$

H = Altitude
P = Pressure at altitude h
P₀ = Pressure at sea level or reference

- Indoor Navigation
- Floor detection
- Drone's: Maintaining constant altitude

 we-online.com/WSEN-PADS



Webinar:

Currently under pressure? Discover our new MEMS pressure sensors



PRODUCTS



WSEN-PDUS Differential Pressure Sensor

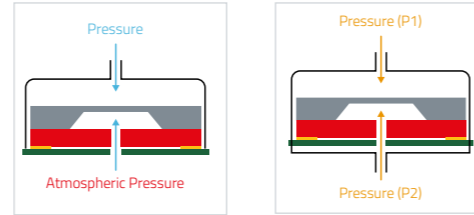

Product Features

- Cut&Tape: No MOQ and small packing units
- Long term availability
- Small size
- Custom calibration values possible

- MEMS based piezo-resistive sensing principle
- Size: 13.8 x 8 x 7.55 mm
- Very high accuracy (up to ±0.25 % FSS tolerance)
- Embedded temperature sensor
- Different transfer functions from ±0.1 kPa to 1 MPa
- Analog & I²C digital communication interface
- 15 bit digital & 11 bit analog pressure output resolution
- Temperature range: -25 °C up to +85 °C

Order Code	P _{RANGE min} (kPa)	P _{RANGE max} (kPa)	ACC _{p_TOT}	V _{DD min} (V)	V _{DD max} (V)
2513130810001	-0.1	0.1	±2.5 %FSS	4.75*	5.25*
2513130810101	-1	1	±0.75 %FSS		
2513130810201	-10	10	±0.75 %FSS		
2513130810401	-100	1000	±0.25 %FSS		
2513130810301	0	100	±0.25 %FSS		
2513130815401	0	1500	±0.25 %FSS		

P_{RANGE min}: Measurement range [min.]; P_{RANGE max}: Measurement range [max.]; ACC_{p_TOT}: Total accuracy [typ.]; V_{DD min}: Operating supply voltage [min.]; V_{DD max}: Operating supply voltage [max.]

* other voltage values e.g. 3.3 V available, see customization next page

Block Diagram

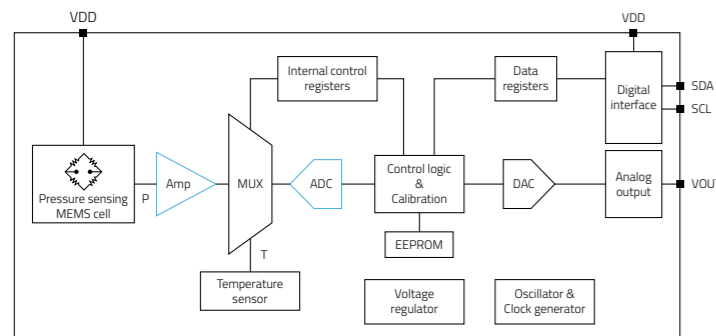

Conversion Table

1	Pa			0.01	mBar
2.5	Pa			0.025	mBar
10	Pa			0.1	mBar
0.1	kPa	1	hPa	1	mBar
1	kPa	10	hPa	10	mBar
10	kPa	100	hPa	100	mBar
26	kPa	260	hPa	260	mBar
100	kPa	1000	hPa	1	Bar
126	kPa	1260	hPa	1.26	Bar
1000	kPa	10,000	hPa	10	Bar

Accuracy

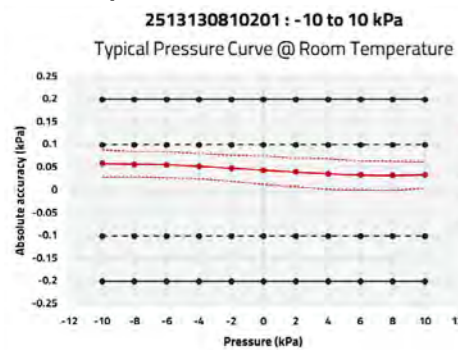

Construction compared to Absolute Pressure

- The sensor package is a bit different from the Absolute pressure sensor. It has two pressure ports on the topside. Port P1 is exposed to the top side of the MEMS sensing element.
- The MEMS sensing element is placed on a ceramic substrate. Silicon and the Ceramic have a similar temperature co-efficient, thermal stress can be minimized. This significantly improves the Mechanical stability of the MEMS. For the reference pressure P2, a pneumatic channel is embedded inside the PCB of the sensor. It comes in a reflow solderable SMD package.

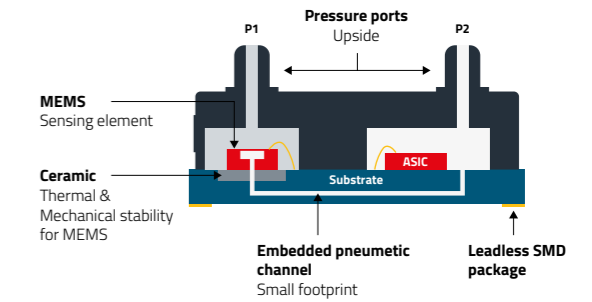

Typical Application - Heating, Ventilation and Air Conditioning (HVAC)

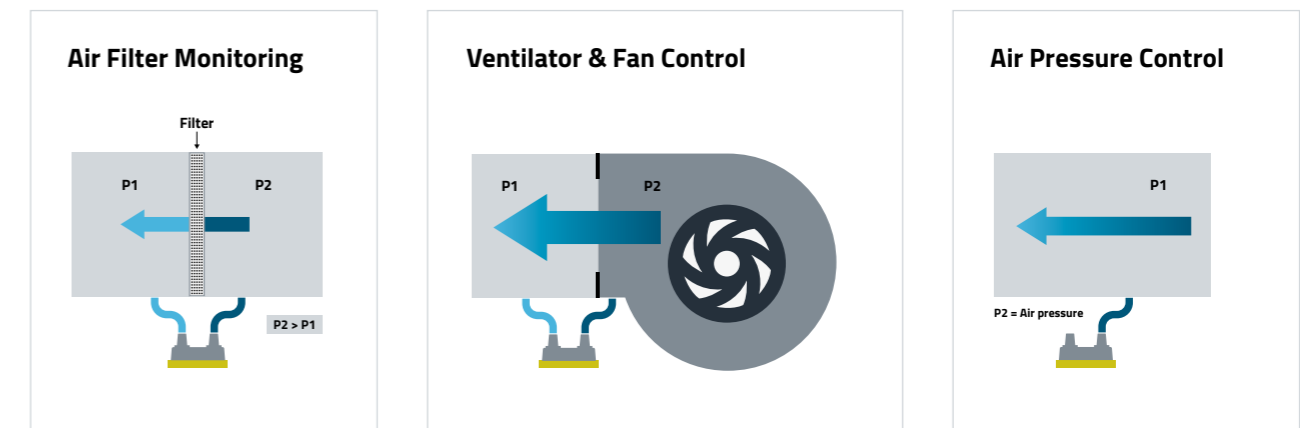

P1 = P2 → No Filter or Clean Filter

P2 > P1 → Clean Filter (Pre-defined)

P2 >> P1 → Change Filter Alert



we-online.com/WSEN-PDUS

WSEN-PDUS CUSTOM OPTIONS

Standard Solution

Standard solution already covers an extensive pressure range, however, this might not be enough for some specific application. For example, an application requires a pressure range from 0 to 4 bar where the system operates on 3.3V supply voltage. Within our standard solutions, the pressure range of -1 to 10 bar would meet the pressure requirement, but it cannot work on 3.3 V supply voltage. With our individualization services, we are able to provide a sensor with operating pressure 0 to 4 bar and supply voltage 3.3 V. Along with the pressure range and supply voltage, many other parameters like communication interface, ADC resolution etc. can also be individualized. Packaging variants with barbed nozzles are also available for the applications where the pneumatic tubes need to be attached directly to the sensor

STANDARD Differential Pressure Sensor

- ✓ Six different pressure ranges with fixed configuration are available
- ✓ These parts are always available ex-stock.

Standard Pressure Ranges

LOW	MEDIUM	HIGH
± 0.1 kPa ± 1 kPa	± 10 kPa 0 to 100 kPa	-100 to 1000 kPa 0 to 1500 kPa

Standard Features

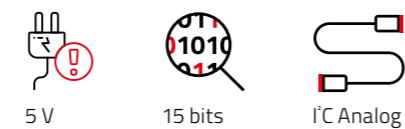

INDIVIDUALIZED Differential Pressure Sensor

- ✓ Customer defines pressure range of the final sensor between -1 bar (-100 kPa) to 15 bar (1500 kPa)
- ✓ Sensor will have a unique part number
- ✓ 100% calibrated, verified and tested

Exemplary Pressure Ranges

LOW	MEDIUM	HIGH
± 2 kPa 0 to 2 kPa	± 50 kPa 0 to 200 kPa	-100 to 700 kPa 0 to 1200 kPa

Additional Features

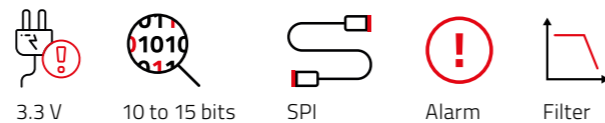

Additional Features that can be individualized

- Get the suitable supply voltage for your application
- Output Resolution between 10 and 15 bits
 - Higher: High Accuracy, but slower response time
 - Lower: Low accuracy, but faster response time
- Noise reduction of output signal through filter
- Select the required digital communication interface supported by your host microcontroller additionally to the analogue output
- Create an Interrupt/Alarm signal based on a pre-configured pressure threshold for power saving

Individualize your sensor

Select one from each category. Digital and Analog voltage communication can be chosen together.

1. PRESSURE RANGE <input type="checkbox"/> FROM (min. ± 0.1 kPa) _____ kPa <input type="checkbox"/> TO _____ kPa	2. RESOLUTION <input type="checkbox"/> 10 bits <input type="checkbox"/> 13 bits <input type="checkbox"/> 11 bits <input type="checkbox"/> 14 bits <input type="checkbox"/> 12 bits <input type="checkbox"/> 15 bits	
3. SUPPLY VOLTAGE <input type="checkbox"/> 5 V <input type="checkbox"/> 3.3 V	4. INTERFACE <input type="checkbox"/> I ² C <input type="checkbox"/> Analog Voltage <input type="checkbox"/> SPI	5. LOW NOISE FILTER <input type="checkbox"/> No <input type="checkbox"/> Yes
6. ALARM <input type="checkbox"/> Disable <input type="checkbox"/> Enable If Alarm enabled, specify the pressure value: _____	7. NOZZLE VARIANT <input type="checkbox"/> Vertical Straight <input type="checkbox"/> Horizontal Barbed	<p>We use our proven programming and testing processes to ensure → high quality and → reliability</p>

Note: ±1 mbar is the smallest possible pressure range. Both the Digital I²C and SPI interfaces are not available simultaneously.



Contact your local sales or email to:
wireless-sales@we-online.com

Package variants

1. Vertical straight nozzles



Ideal for manifold mounting

Advantage:
 Manifold mounting (i.e. Adapter or housing) reduces the mechanical stress on the sensor as well as on the solder joints. This is especially important for the longevity of the sensors when they are used in high pressure (above 200 kPa) applications

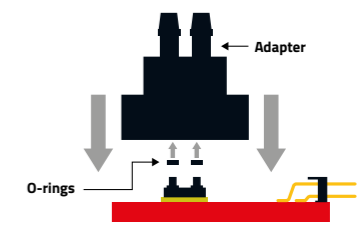

2. Horizontal barbed nozzle

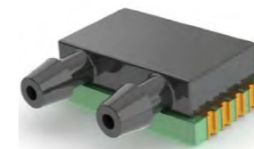

Pneumatic tubes with inner diameter 2 mm could be directly connected

Advantage:
 Barbed connections allow for a straightforward push-in connection of pneumatic tubes and cannot be easily disconnected.

SENSOR SOFTWARE DEVELOPMENT KIT

Communication with the sensors is done by reading from and writing to registers via I²C and/or SPI interfaces. The manuals and app notes describe the usage of the sensors on register level. The Sensors SDK is an abstraction layer that provides functions and data types which handle the low-level communication with the sensor at register level for you. This allows easy access to the functions behind the registers.

The SDK is Open source, written in C, ready-to-use in customer software and can also be modified by customers as required by their application.



Features

- Conversion of sensor readings (raw data to user units) for different sensor configurations.
- Communication layer (I²C, SPI) – pre-configured and ready-to-use for each type of sensor.
- Configuration and control of e.g.
 - Data rates
 - Operating modes
 - Interrupts
 - Buffering and batch transfer of sensor readings (FIFO)
 - Embedded functions (e.g. free-fall detection for acceleration sensor or detection of high/low pressure events for absolute pressure sensor)

Extensive examples for both basic and advanced usage - providing an overview of the sensor's functionality, low-threshold way of getting acquainted with the sensors (-> prototyping)

Basic usage

E.g. operating modes, data rates, interpreting raw data, one shot sensor read

Advanced usage

E.g. Embedded functions, interrupts, buffering of data (FIFO)

"Plug-and-play" support

"Plug-and-play" support of currently two STM32 microcontrollers (STM32G031, STM32L432) - SDK structure allows adaption to other STM controllers and porting to other MCUs by replacing platform-specific functions (basically functions performing low-level communication via I²C or SPI and setting up Clocks, Timers, GPIOs and Interrupts).

A **graphic** showing two simplified use-cases, such as reading single values triggered by the host or reading a batch of buffered values triggered by a sensor event (such as wake-up, free-fall etc.).

The left hand flow of the graphic matches the code comparison below.

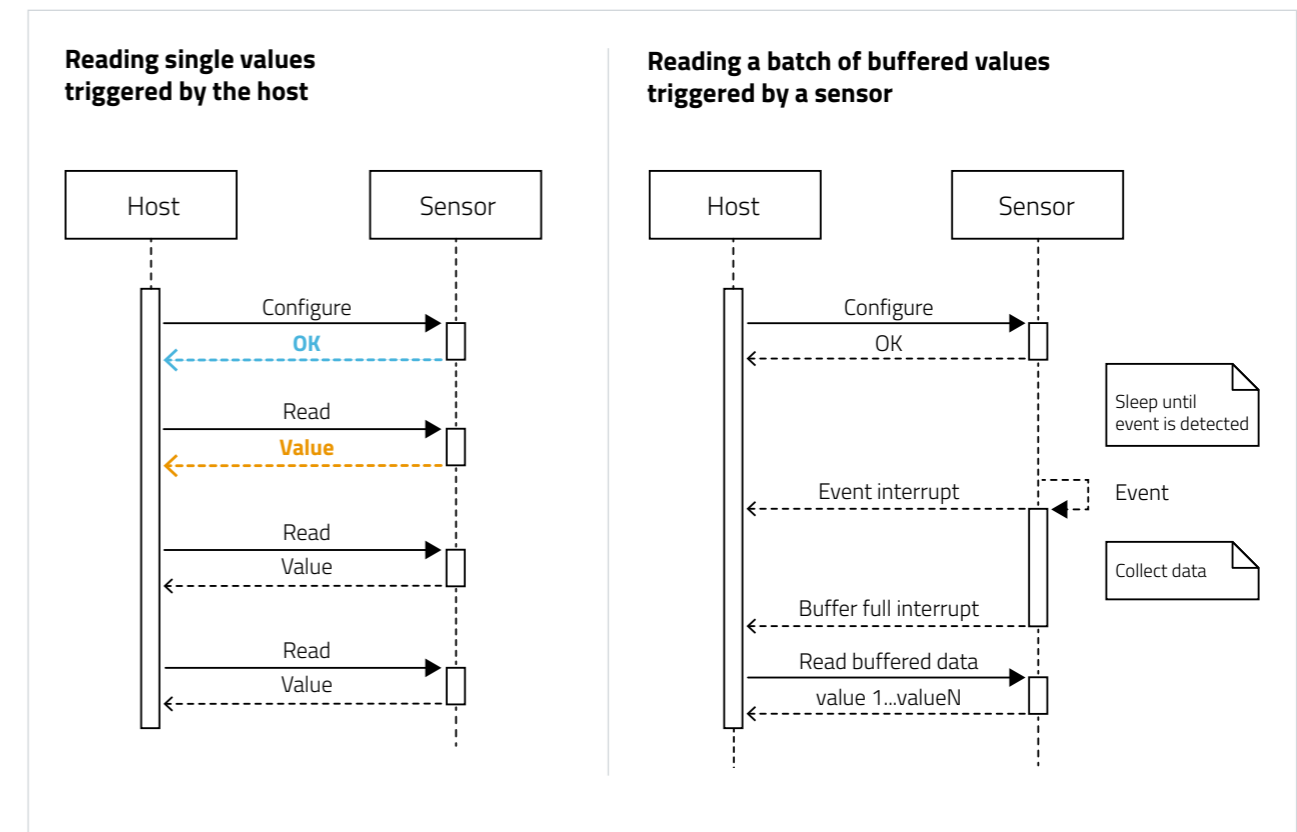

Code Comparison „Reading single values“ – With and without SDK

WITHOUT SDK

Short but not readable

Init:

1. Write value 0x64 into register 0x20
2. Write value 0x0C into register 0x21
3. Write value 0x04 into register 0x25
4. Wait until bit 0 of register 0x27 is '1'
5. Read registers 0x28 to 0x2D, combine pairs into 16 bit values for x,y and z
6. Multiply with "acceleration sensitivity" value to convert raw values to user units

WITH SDK

Longer but readable

Init:

1. SetOutputDataRate(200Hz)
2. EnableHighPerformanceMode(true)
3. EnableBlockDataUpdate(true)
4. EnableAutoIncrement(true)
5. EnableLowNoise(true)
6. SetFullScale(2g)
7. Wait until IsAccelerationDataReady() returns true
8. getAccelerationsData(x,y,z)

ADDED VALUES

Development Tools

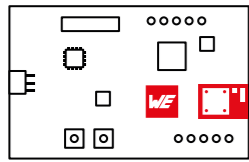

Eval Boards

- Easy testing
- No problem with hand soldering of small sensors
- I²C directly accessible



we-online.com/EVAL-SENS



More information on page 151



FeatherWing

- Adafruit standard
- Easy connectable
- For complex system tests



More information on page 154

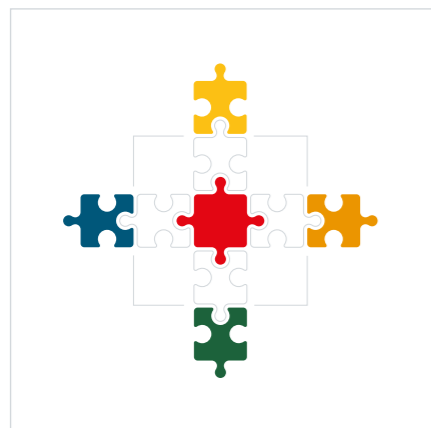

Software Development Kit

- Typically as C-Files, for mobile Apps platform specific languages
- For comfortable coding of:
 - The HOST-controller system
 - PC Applications & Mobile Apps
- Code examples in Application notes and Manuals



we-online.com/WSEN-SDK

AppNotes



AppNote: MEMS Sensor PCB Design and Soldering Guidelines

we-online.com/ANM001



Human Fall Detection with 3-Axis MEMS Acceleration Sensor

we-online.com/ANM002



Pressure Altimeter using Absolute Pressure Sensor WSEN-PADS

we-online.com/ANM003

WÜRTH ELEKTRONIK MORE THAN YOU EXPECT

KEEP IT SIMPLE! SENSE WITH MEMS



MEMS Sensor Portfolio & Customer Service

Sensors are an integral part of every future application. Measuring temperature, humidity, pressure or acceleration has never been easier. Take advantage of services like our Software Development Kit and Evaluation Boards available off-the-shelf. Detailed documentations as well as the direct support by trained engineers will leave no questions open. With excellent measuring accuracy and long-term stability, the sensors provide high precision and accurate output values with intelligent on-chip interrupt functions.

- Support by engineers within 24 h
- Excellent measuring accuracy
- Factory calibrated & ready to use
- On-chip interrupt functions
- Implemented algorithms
- SPI & I²C digital interfaces

Combine sensors and wireless connectivity – start your IoT application today:
www.we-online.com/sensors



#SensewithMEMS

SOFTWARE TOOLS

IoT will become intelligent when hardware and software work harmoniously together!

Würth Elektronik provides a variety of software development kits (SDK) and software tools to test the wireless connection and to speed up the design processes. All tools and software development kits, can be downloaded for free in our online shop as required by their application.

GitHub

Würth Elektronik eiSos GitHub page

In order to ensure ease-of-use for the developers, all our SDK are available on the GitHub platform. Please visit the Würth Elektronik eiSos GitHub page to find the latest version of our SDKs.



Wireless Connectivity Software Development Kit (SDK)

The aim of the Wireless Connectivity SDK is to minimize the effort required on customer side to enable his host MCU to communicate with Würth Elektronik eiSos radio modules. It contains the implementation of all available commands in pure C-code. In order to integrate any Würth Elektronik eiSos wireless module, the user has to simply port the corresponding C-code to his host processor. This significantly reduces the time needed for developing the software interface to the radio module.



Smart commander tool

The WE Smart Commander is an easy-to-use PC software that enables complete control of the Würth Elektronik eiSos wireless modules through an intuitive GUI. This tool along with the evaluation boards allow quick prototyping and testing of various features of the radio modules.

- Simple setup
- Intuitive interface
- Color coded Packet interpretation
- 100% log traceability

The Smart Commander itself is an executable and does not require installation. It will create folders and files on the hard drive e.g. for log file storing. However, the serial-to-USB FTDI converter chip (i.e. FT232R) on the evaluation platform or USB dongles requires special drivers to be installed for proper operation. To use USB dongles or evaluation boards of Würth Elektronik eiSos wireless connectivity modules, the Virtual COM Port (VCP) drivers have to be installed by following the "Installation Guides" of FTDI found under:

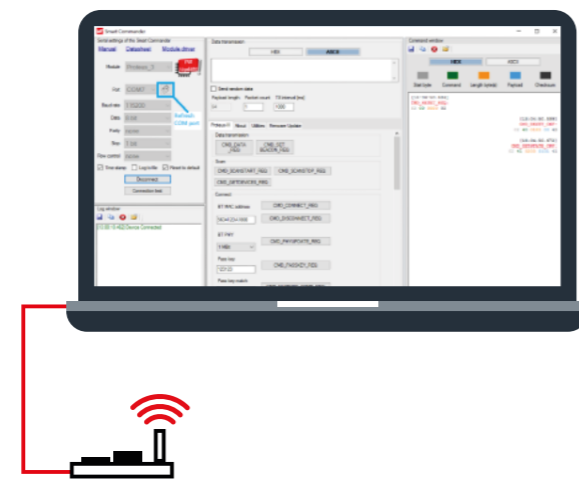

AT commander tool

The AT command tool is a simple PC software that enables complete control of the Calypso Wi-Fi module via the AT Command interface. This tool offers an intuitive graphical user interface that enables the user to interact with the Calypso and understand the syntax and semantics of the AT command interface. The AT command tool works out-of-the-box with the Calypso evaluation board. This tool along with the Calypso evaluation board allows quick prototyping and testing of various features of the Calypso Wi-Fi module.

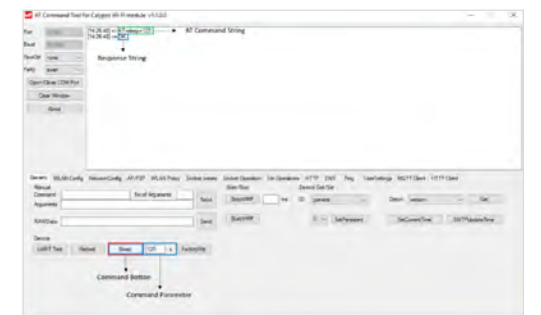

Wirepas commander tool

The Wirepas module Commander is an easy-to-use PC software that enables complete control of the Wirepas module via its command interface. This tool offers an intuitive graphical user interface that enables the user to interact with the wireless module and understand the communication protocol between the module and the connected host.

The Wirepas module Commander along with the Wirepas module allows quick prototyping and testing of various features of the Wirepas mesh network.

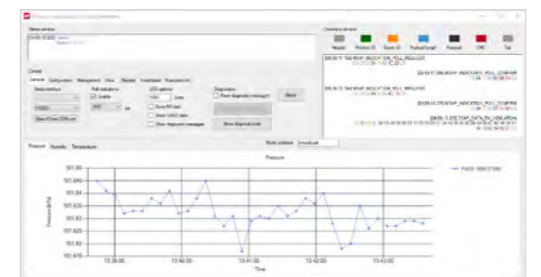

ACC-Tool

The "ACC V3" is a tool to update and configure certain Würth Elektronik eiSos modules. The supported features will include the search and upload of new firmwares as well as the modification of the available configuration parameters. It allows full user control over all supported products, as in the range of the producer's intentions, always referring to the respective manual of the connected module.

Due to current export legal restrictions, we are required to control the provision of software. To download the software, please contact our technical support or your local sales representative directly.



Contact technical support:
support@we-online.com
we-online.com/find-your-engineer



SOFTWARE TOOLS

Adrastea Commander

The Adrastea Commander is a simple PC tool to interact with the EV-Boards of the Würth Elektronik eiSos cellular module via AT Command interface. This offers evaluation of Adrastea-I module capabilities and features. It is simplified for the configuration of the module using AT commands without knowledge of the protocols. Quick selection and Command List allows to save and send AT commands with a mouse click.

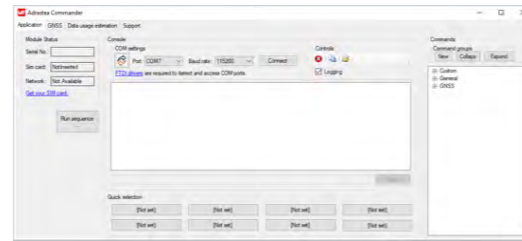

The Adrastea Commander tool makes easy evaluation of GNSS functionality of Adrastea-I module. The Adrastea Commander tool also offers data usage estimation to get an idea how much data is required for the application.

 we-online.com/Adrastea-Commander

Proteus Connect App SDKs and source code for BLE

The proteus connect SDKs enable development of software applications for smart devices that connect and exchange data with BLE modules from Würth Elektronik eiSos. The Proteus connect SDK is available for the following platforms:



Android
github.com/WurthElektronik/Proteus-Connect-Android



iOS
github.com/WurthElektronik/Proteus-Connect-iOS

Windows
github.com/WurthElektronik/Proteus-Windows-SDK



WENSS - Würth Elektronik Navigation Satellite Software

Würth Elektronik Navigation and Satellite Software, WENSS for short, is a simple PC tool to interact with the EV-Boards of the Würth Elektronik eiSos positioning modules using the UART interface. It allows:

- Taking into operation of the EV-board
- Bidirectional communication with the GNSS module
- Evaluation of module capabilities and features
- Getting familiar with module protocols, sentences and commands
- Configuration of the module without knowledge of the protocols
- Parsing of sentences and commands

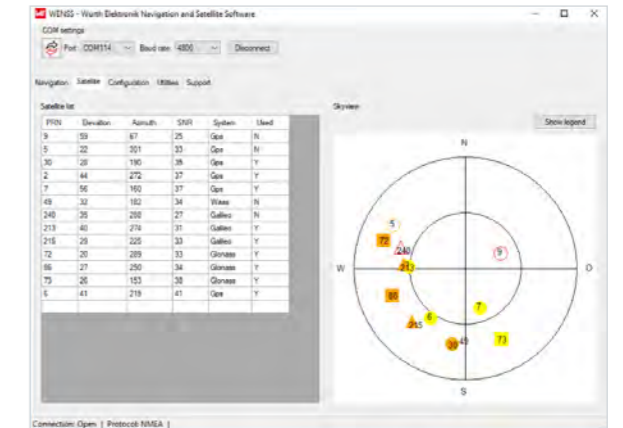

Experienced users have the opportunity to use WENSS for more advanced configurations. Therefore it allows an easy evaluation of positioning application.

 we-online.com/WENSS

ACCESSORIES

WIRELESS CONNECTIVITY



Radio Module

A radio module is a A-component, which is used for wireless communication between devices such as control systems, remote controls, sensors et cetera.



USB Radio Stick

A USB Radio Stick consists of radio module along with a serial-to-USB adapter that enables direct connection to any USB compatible device. A FTDI serial-to-USB converter chip FT231X connects the USB interface of the Radio stick to the UART pins of the integrated radio module.

- Including all necessary certification
- Can be used Plug&Play

ACCESSORIES

SENSORS

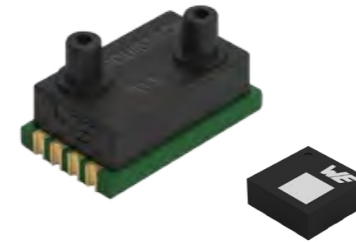

Sensor (Component)

A sensor is a A-component, which is used to produce an output signal for the purpose of sensing a physical phenomenon.



Sensor Node

The sensor nodes function is to repeatedly read the respective sensor values via I²C and send them via Wirepas mesh network to a sink device. It contains:

- The Wirepas radio module Thetis-I
- Several Würth Elektronik eiSos sensors
 - WSEN-PADS
 - WSEN-HIDS
 - WSEN-TIDS
- CR2032 battery holder

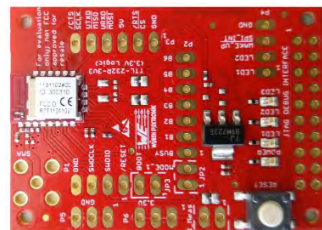

Mini – Evaluation Board

The mini evaluation board is an intuitive, application oriented and cost effective version of the Evaluation kit. It offers the possibility to develop hard- and software for the radio module.

- Not assembled with connectors and pinheaders
- Intended for experienced developers

A PCB containing only one radio module to access all pins without any soldering effort. Can be used Plug&Play to connect a radio module directly to any host microcontroller by lose wires.



Evaluation Kit

The Evaluation Kit contains all necessary equipment like

- USB cable
- USB radio stick (if required)
- A 2nd evaluation board (for e.g. long range tests)
- Antennas (if external antenna configuration is chosen)

The included Evaluation board offers the user the possibility to develop hard- and software for the compatible radio module. It can be connected to an USB port of a PC.

- Equipped with a multi-pin connector (which is connected to all pins of the RF module)
- Jumpers allow the module to be disconnected (from components such as the USB interface)



Evaluation Board

The evaluation board of the sensor provides an opportunity to verify the sensor performance and develop a prototype using an external processor.

- Can be directly plugged to another kit using the mounted I²C and SPI interface pins
- Can also be placed on a bread board using through hole pin header connections



Sensor Shield for Arduino

The evaluation board "Sensor Shield for Arduino" is a stackable extension board for the Arduino (UNO and DUE) board. It can be used to connect all Sensor EVAL-Boards:

- WSEN-HIDS
- WSEN-TIDS
- WSEN-ITDS
- WSEN-PADS
- WSEN-PDUS

WE ADAFRUIT FEATHERWINGS



Würth Elektronik eiSos presents, a range of FeatherWing development boards that are open source and fully compatible with the Feather form factor. Through these development boards WE brings a range of wireless connectivity modules, sensors and power modules to the Feather ecosystem.

Adafruit Feather is a complete line of development boards from Adafruit and other developers that are both standalone and stackable. They're able to be powered by LiPo batteries for on-the-go use or by their micro-

USB plugs for stationary projects. Feathers are flexible, portable, and as light as their namesake.

FeatherWings are stacking boards and add functionality and room for prototyping. At its core, the Adafruit Feather is a complete ecosystem of products - and the best way to get your project flying.

Supercharge your prototyping for easy and fast solution testing.

	<p>Sensor FeatherWing (2501000201291)</p> <ul style="list-style-type: none"> Acceleration sensor (WSEN-ITDS) Absolute Pressure sensor (WSEN-PADS) Temperature sensor (WSEN-TIDS) Humidity sensor (WSEN-HIDS) Sparfun QWIIC connector to enable easy access to hundreds of extension boards
	<p>Thyone-I Wireless FeatherWing (2611059021001)</p> <ul style="list-style-type: none"> Proprietary 2.4 GHz RF-Module Connecting wirelessly up to 300 m Microchip ATECC608B secure element for encryption and authentication Connect to Thyone-I modules or USB-Sticks
	<p>Calypso Wi-Fi FeatherWing (2610039025001)</p> <ul style="list-style-type: none"> 2.4 GHz Wi-Fi connectivity Easy connection to Smart Devices Secure data transfer to the cloud UART-to-Wi-Fi bridge
	<p>MagI³C Power FeatherWing (2601157100001)</p> <ul style="list-style-type: none"> Input from industrial voltage rails of 9V, 12V, 15V, 18V, 24V or from 5V USB Output 5V and 3.3V to power the Feather system
	<p>Connect any Feather Microcontroller</p> <p>Choose any from a range of microcontroller boards from the Adafruit family.</p>

FEATHERWINGS APPLICATION EXAMPLES

EXAMPLE 1: Built up a Proprietary Network

- Select a microprocessor of your choice from the Adafruit Feather ecosystem
- Use the Sensor FeatherWing for measuring condition parameters like temperature, air pressure, humidity and acceleration
- Send data with the Thyone-I FeatherWing on 2.4 GHz proprietary radio
- Thyone-I USB radio stick or another Thyone-I FeatherWing can receive the data and you get access to all information
- Even various tags could be connected wirelessly
- We support you with libraries and examples available on Github for some microcontrollers

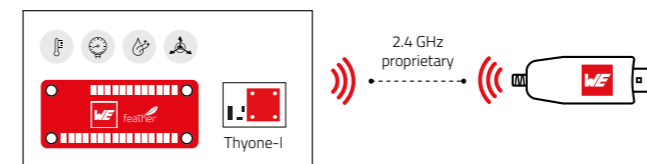

EXAMPLE 2: Connect with Wi-Fi

- Select a microprocessor of your choice from the Adafruit Feather ecosystem
- Use the Sensor FeatherWing for measuring condition parameters like temperature, air pressure, humidity and acceleration
- Send out data with the Calypso FeatherWing on 2.4 GHz Wi-Fi
- Receive data on smart devices or server structures



EXAMPLE 3: Sensor to Cloud

Another simple application example is described here with the combination of an Adafruit Feather M0 Express with our Sensor FeatherWing and Calypso Wi-Fi FeatherWing.

A typical IoT application consists of sensing the environment through sensors, collecting the sensor data and forwarding it to a cloud. The cloud platform then provides options for further processing and visualization of the data. In this example, the data is read from the sensors of the Sensor FeatherWing and forwarded to a cloud platform via the Calypso Wi-Fi FeatherWing.

Currently, the data can be sent to one of the following cloud platforms: **Microsoft Azure** and **Amazon AWS**. Sample code and further documentation can be found on our Sensor2CloudConnectivity Github page.

4 sensors to measure environmental data:

- Temperature
- Humidity
- Acceleration
- Absolute Pressure

An Adafruit Feather M0 acts as managing director.

The Calypso Wi-Fi FeatherWing collects the sensor data and passes it on to any cloud.

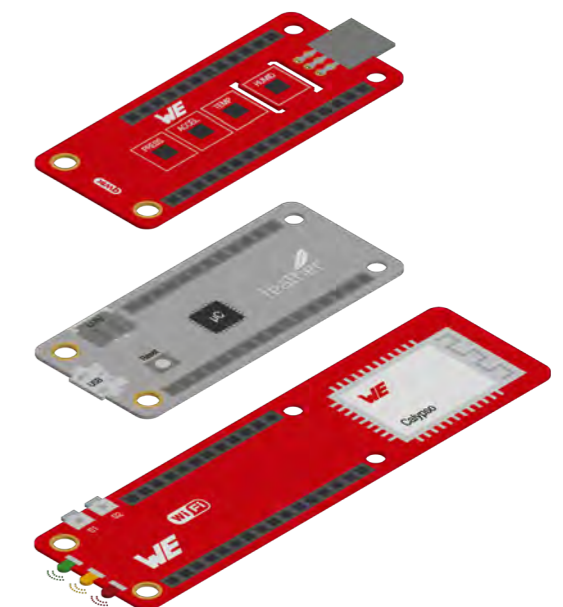

GitHub

github.com/WurthElektronik/FeatherWings

SENSOR FEATHER WING

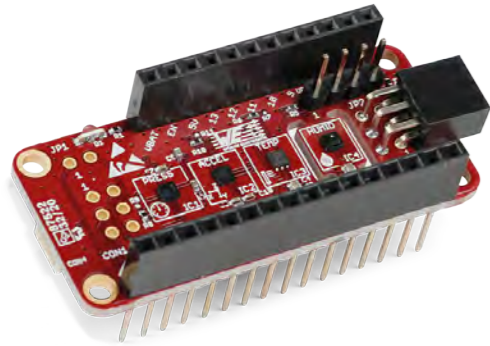

Sensor FeatherWing

Environment and motion sensing



Characteristics



- All the four sensors are connected over the shared I²C bus
- In Adafruit Feather form-factor
- Compatible with QWIIC-connect from Sparkfun
- Easy to expand with our WE FeatherWings and hundreds of already existing boards with the Feather and QWIIC form-factor
- Arduino (C/C++) drivers and code examples available on Github

Applications

- Development of IoT applications
- Rapid prototyping
- Collection of environmental data

ADDED VALUES

- ✓ Hardware design files available for download
- ✓ Drivers in C/C++ for all WE components
- ✓ Examples including source code in C/C++
- ✓ Extensive documentation including step-by-step guides

CALYPSO WI-FI FEATHER WING

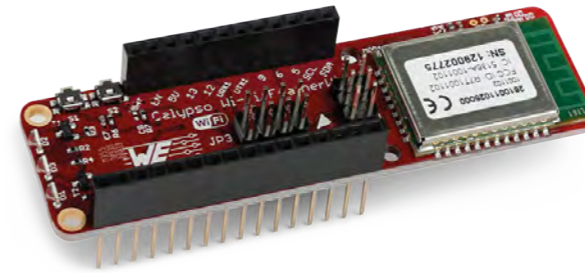

Calypso Wi-Fi FeatherWing

2.4 GHz Wi-Fi Connectivity



Characteristics

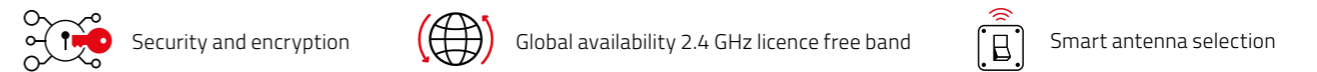

- 2.4 GHz IEEE 802.11 b/g/n Wi-Fi Connectivity
- Full TCP/TLS stack with IPv4 and IPv6
- Out-of-the-box implementation of several commonly used network applications like SNMP, DHCPv4, DHCPv6, mDNS, HTTP(S), MQTT
- Direct and secure connection to cloud
- Low power modes for battery operated system
- Secure boot, secure storage and secure connectivity

Applications

- Rapid development of IoT applications
- Easy to use platform for learning, experimenting and prototyping cloud connectivity applications
- Collect sensor data, store it in a database and then visualize the data

App Note



Calypso Cloud Connectivity

we-online.com/ANR023

ADDED VALUES

- ✓ Hardware design files available for download
- ✓ Drivers in C/C++ for all WE components
- ✓ Examples including source code in C/C++
- ✓ Extensive documentation including step-by-step guides

THYONE-I WIRELESS FEATHER WING



Thyone-I Wireless FeatherWing

2.4 GHz Proprietary Wireless connectivity



Characteristics



Long life battery driven application with sleep current = 0.4 μ A



Global availability 2.4 GHz license free band



Mesh



Encryption

- FeatherWing with proprietary 2.4 GHz RF module
- Wireless connection with up to 300 m
- Data Encryption (AES128)
- Integrated security/authentication IC
- Point -to-point connection to Thyone-I module or Thyone-I USB stick

- Mesh network capable
- Low power modes of operation
- In Adafruit Feather form factor

Applications

- Development of IoT applications
- Fast prototyping
- Low power sensor node

ADDED VALUES

- ✓ Hardware design files available for download
- ✓ Drivers in C/C++ for all WE components
- ✓ Examples including source code in C/C++
- ✓ Extensive documentation including step-by-step guides

MAGI³C POWER FEATHER WING

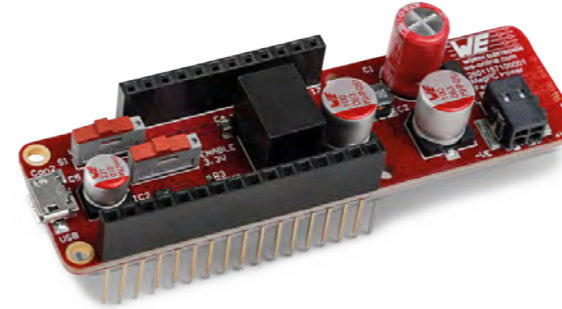

Magi³C Power FeatherWing

Power the Feather stack with any industrial power source



Characteristics

✓ Industrial Input 6 V - 36 V

✓ EN55032 Class B compliant

✓ Internal soft-start

✓ Thermal shutdown

- Operating input voltage of 9 V, 12 V, 15 V, 18 V and 24 V industrial rails
- Maximum 36 V input voltage
- Additional USB connector for 5 V input voltage to select by switch

- Transformation of industrial input voltage to 5 V
- Transformation of 5 V to 3.3 V
- Enable functionality and mode selection available to control and tune performance of Magi³C MicroModule

Applications

Supply the FeatherWing system with power from industrial power sources.

ADDED VALUES

- ✓ Hardware design files available for download
- ✓ Extensive documentation including step-by-step guides

ACCESSORIES

Order Code	Name	Information	Eval Board	USB-Stick	Antenna
2608011024000	Proteus-I	Bluetooth® LE 4.2 with integrated antenna	2608019024001	-	-
2608011124000	Proteus-I	Bluetooth® LE 4.2 with RF pad	2608019324001	-	2600130021 (Himalia)
2608011024010	Proteus-II	Bluetooth® LE 5.0 with integrated antenna	2608019024011	2608036024011	-
2608011124010	Proteus-II	Bluetooth® LE 5.0 with RF pad	2608019324011	2608036024011	2600130021 (Himalia)
2611011024000	Proteus-III	Bluetooth® LE 5.1 with smart antenna selection	2611019024001	2611036024001	2600130021 (Himalia)
			Mini Eval Board*: 2611069024001		
2611011024010	Proteus-III-SPI	Bluetooth® LE 5.1 with SPI interface	2611119024011	-	2600130021 (Himalia)
2612011024000	Proteus-e	Bluetooth® LE 5.1 module	2612019024001	-	2600130021 (Himalia)
2610011025000	Calypso	2.4 GHz Wi-Fi module	2610019225001	-	2600130021 (Himalia)
2603011021000	Triton	2.4 GHz proprietary module with integrated antenna	2603019021001	-	-
2603011121000	Triton	2.4 GHz proprietary module with RF pad	2603019321001	-	2600130021 (Himalia)
2606031021000	Thalassa	2.4 GHz proprietary module with integrated antenna	2606039021001	2606046021001	-
2606031121000	Thalassa	2.4 GHz proprietary module with RF pad	2606039221001	2606046021001	2600130021 (Himalia)
2606031321000	Thalassa	2.4 GHz proprietary module with U.FL connector	-	2606046021001	2600130021 (Himalia)
2607011111000	Titania	169 MHz proprietary module with RF pad	2607019211001	2607046211001	2600130011 (Helike)
2605031141000	Thadeus	434 MHz proprietary module with RF pad	2605039241001	-	2600130041 (Herse)
2605041181000	Tarvos-I	868 MHz proprietary module with RF pad	2605049281001	2605056081001	2600130081 (Hyperion-I) 2600130082 (Hyperion-II)
2607021181000	Tarvos-II	868 MHz proprietary module with RF pad	2607029281001	2607056281001	2600130081 (Hyperion-I) 2600130082 (Hyperion-II)
2609011081000	Tarvos-III	868 MHz proprietary module with integrated antenna	-	2609026281001	-
2609011181000	Tarvos-III	868 MHz proprietary module with RF pad	2609019281001	2609026281001	2600130081 (Hyperion-I) 2600130082 (Hyperion-II)
2609031181000	Thebe-II	868 MHz proprietary module with RF pad	2609039281001	-	2600130081 (Hyperion-I) 2600130082 (Hyperion-II)
2607021191000	Telesto-I	915 MHz proprietary module with RF pad	2607029291001	2607056291001	2600130083 (Hydra-I)
2607021191010	Telesto-II	915 MHz proprietary module with RF pad	2607029291011	2607056291011	2600130083 (Hydra-I)
2609011091000	Telesto-III	915 MHz proprietary module with integrated antenna	-	2609026291001	-
2609011191000	Telesto-III	915 MHz proprietary module with RF pad	2609019291001	2609026291001	2600130083 (Hydra-I)
2609041191000	Themisto-I	915 MHz proprietary module with RF pad	2609049291001	-	2600130083 (Hydra-I)
2611011021000	Thyone-I	2.4 GHz proprietary module; smart antenna selection	2611019021001	2611036021001	2600130021 (Himalia)
			Mini Eval Board*: 2611079021001		
			Long Range Board: 2611017221001		
2611011021010	Thetis-I	2.4 GHz Wirepas Mesh module	2611019021011	2611086021011	2600130021 (Himalia)

Order Code	Name	Information	Eval Board	USB-Stick	Antenna
2615011136000	Adrastea-I	LTE-M / NB-IoT Cellular module with GNSS	2615029236001	-	-

Order Code	Name	Information	Eval Board	USB-Stick	Antenna
2612011022000	Ophelia-I	2.4 GHz radio module without firmware	2612019022001	-	2600130021 (Himalia)

Order Code	Name	Information	Eval Board	USB-Stick	Antenna
2611011024020	Setebos-I	2.4 GHz radio module with proprietary and Bluetooth® LE 5.1 radio protocol	2611129024021	-	2600130021 (Himalia)

Order Code	Name	Information	Eval Board	USB-Stick	Antenna
2607011113000	Mimas-I	169 MHz wM-BUS module	2607019213001	2607046213001	2600130011 (Helike)
2605041183000	Metis-I	868 MHz wM-BUS module	2605049283001	2605056083001	2600130081 (Hyperion-I) 2600130082 (Hyperion-II)
2607021183000	Metis-II	868 MHz wM-BUS module	2607029283001	2607056283001	
2607056283011	Metis-II	868 MHz wM-BUS radio simulation USB-Stick	-	-	
2607057283011	Metis-Analyzer Tool	868 MHz wM-BUS radio Analyzer USB-Stick	-	-	

Order Code	Name	Information	Eval Board	USB-Stick	Antenna
2613011037000	Elara-I	GPS, GLONASS with Integrated Antenna	2613019037001	-	-
			Extended EV-Kit with Thyone-I RF interface: 2613019037011	2611036021001	
2613021137000	Elara-II	GPS, GLONASS with RF pad	2613029237001	-	2600130016 (Halimede-I) 7488920157 (WE-MCA)
			Extended EV-Kit with Thyone-I RF interface: 2613029237011	2611036021001	
2614011037000	Erinome-I	GPS, GLONASS, Galileo, BeiDou with Integrated Antenna	2614019037001	-	-
			Extended EV-Kit with Thyone-I RF interface: 2614019037011	2611036021001	
2614021137000	Erinome-II	GPS, GLONASS, Galileo, BeiDou with RF pad	2614029237001	-	2600130016 (Halimede-I) 7488920157 (WE-MCA)
			Extended EV-Kit with Thyone-I RF interface: 2614029237011	2611036021001	

Order Code	Name	Information	Eval Board
2533020201601	WSEN-ITDS	3 axis acceleration sensor	2533203301691
2521020222501	WSEN-TIDS	Temperature sensor	2521020222591
2525020210001	WSEN-HIDS	Humidity sensor	2525020210091
2511020213301	WSEN-PADS	Absolute pressure sensor	2511223013391
2513130810001	WSEN-PDUS	Differential pressure sensor (-0.1 - 0.1 kPa; -1-1 mbar)	2513254510091
2513130810101	WSEN-PDUS	Differential pressure sensor (-1-1 kPa; -10-10 mbar)	2513254510191
2513130810201	WSEN-PDUS	Differential pressure sensor (-10-10 kPa; -0.1-0.1 bar)	2513254510291
2513130810301	WSEN-PDUS	Differential pressure sensor (0-100 kPa; 0-1 bar)	2513254510391
2513130810401	WSEN-PDUS	Differential pressure sensor (-100-1000 kPa; -1-10 bar)	2513254510491
2513130815401	WSEN-PDUS	Differential pressure sensor (0-1500 kPa; 0-15 bar)	2513254515491

Order Code	Name	Information	Eval Board	USB-Stick	Antenna
2501000101291	Arduino-Shield	Sensor Shield for ArduinoI	-	-	-
2501000201291	Sensor FeatherWing	WSEN-ITDS, -PADS, -TIDS, -HIDS integrated	-	-	-
2611059021001	Thyone-I FeatherWing	Proprietary 2.4 GHz RF-Module Connection	-	2611036021001	2600130021 (Himalia)
2610039025001	Calypso FeatherWing	Wi-Fi-Connection 2.4 GHz	-	-	2600130021 (Himalia)

* Connector Kit 699100

ELECTRONIC & ELECTROMECHANICAL COMPONENTS



EMC Components



Power Magnetics



Signal & Communications



Quartz & Oscillators



Capacitors



Resistors



Automotive Standard Products



Optoelectronics



Power Modules

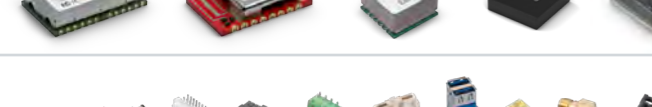

Wireless Connectivity & Sensors



Connectors



Fuseholders



Switches



Assembly Technique



REDCUBE Terminals

WÜRTH ELEKTRONIK MORE THAN YOU EXPECT



CREATING IDEAS





SMART FARMING

TAKE YOUR FARMING TO THE NEXT LEVEL

Climate change, loss of arable land, ever scarcer resources and a growing world population. There are more and more challenges in food production. New approaches are being sought to meet these challenges. One of them is smart farming.

With our WE line of FeatherWings you can rapidly prototype your own smart farming application. With the help of the Sensor FeatherWing you can measure data points such as temperature and humidity to check if the plants are feeling most comfortable.

This created data can be sent into any cloud using the Calypso Wi-Fi FeatherWing. On Github, we are providing quickstarts and example-code to get data into Microsoft and Amazon IoT platforms. Here, the data can be displayed, stored and analyzed to optimize plant output.

Benefits

Actuators can now be controlled manually or automatically via RPC

- ✓ Turn on water pump to water the soil if the moisture is too low.
- ✓ Automatically fertilize the soil.
- ✓ Change the color and brightness of the LED depending on the time of day and the development of the plant.



CREATE DATA

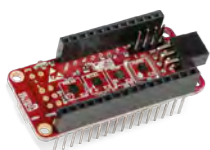

Sensor FeatherWing

4 sensors connected over shared I²C in Adafruit Feather form-factor

- WSEN-TIDS for temperature sensing
- WSEN-HIDS for humidity sensing

Sensing environmental conditions like temperature and potting soil humidity

SEND DATA



Calypso Wi-Fi FeatherWing

- Wi-Fi-Connection 2.4 GHz
- Easy connection to Smart Devices
- Sending data to the server
- Handling multiple sensor nodes

Sending the collected data from the sensors into the cloud platform

ANALYZE DATA



IoT Platform

- Send data to any cloud for further use
- Create real IoT use cases
- Examples and Sourcecode available on GitHub for Microsoft Azure and Amazon Web Services

LED-CONTROLLING



Lighting Development Kit

- Regulate LED for best performance
- Dimming 0 - 100%
- Deep Blue, Hyper Red, Far Red and White
- Output up to 30umol/s



M0 Microcontroller Feather

- Receive and send sensor data
- ARM Cortex M0+ processor
- clocked at 48 MHz and at 3.3V logic
- 256K of FLASH

POWER TOOLS

SMART INDUSTRY – CONNECTED POWER TOOLS

Professional power tools have to perform at high levels and must be able to endure a tough workload. The Industrial Internet of Things enables better management of expensive tools via wireless communication. In conjunction with sensors that monitor appropriate use, new business areas, such as the leasing of equipment, are opening up.

The slim and energy-saving Wi-Fi and Bluetooth modules from Würth Elektronik make power tools capable of communicating. The devices can be linked up anywhere - in the workshop, in the vehicle, or on the construction site. In conjunction with temperature, humidity and motion sensors, the tools become smart. They can transfer data concerning usage and wear to a cloud application for instance. The advantage: maintenance cycles can optimally be scheduled, and rental equipment can be billed based on actual usage. Furthermore, inappropriate use or damage can additionally be detected with the help of sensors.

Benefits

Power tools capture data concerning the usage and share it wirelessly

- ✓ Access to device data at any time.
- ✓ Wireless data access prevents penetration of dust and water.
- ✓ Opportunity to install further systems, e.g. for localization of tools or sensors for drop detection.
- ✓ Data can be extracted, e.g. via a mobile app.

HUMIDITY & TEMPERATURE

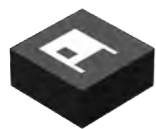

WSEN-HIDS

- 16 bit humidity and temperature output
- I²C and SPI interface
- 2 x 2 x 0.9 mm

Sensing Humidity & temperature of the environment to ensure the vacuum cleaner is used in right operating conditions.

ACCELERATION

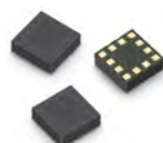

WSEN-ITDS

- 3 axis acceleration
- 14 bit output resolution
- ±2g, ±4g, ±8g, ±16g
- 2 x 2 x 0.7 mm

Sensing Acceleration for vandalism protection.

BLUETOOTH



Proteus-III

- Bluetooth® LE 5.1
- Nordic nRF52840
- 8 dBm output power
- 12 x 8 x 2 mm

Connection between the tools, which want to be used in Sync mode: Sync mode one master tool controls the other(s). Meaning, activating this tool via the tool trigger will activate the synchronized tool(s) as well.

WI-FI



Calypso

- IEEE 802.11 b/g/n, 2.4 GHz
- +18 dBm output power
- 19 x 27,5 x 4 mm

Connect the control unit to Internet: Cloud connectivity for status informations, changes to the settings from anywhere in the world.

CELLULAR



Adrastea-I

- LTE-NB.IoT / Cat.M1
- incl. GNSS
- 14 x 13 x 2 mm

Connect the control unit to Internet: Cloud connectivity for status informations, changes to the settings from anywhere in the world etc.

DIGITAL TOOLS



POWER TOOLS IOT CONNECTIVITY

The interconnection of power tools offers various advantages and applications. Especially with battery-powered tools, there is no longer a connection between the tools, which does not allow a synchronized function.

With the help of Bluetooth networking, the various tools can be operated in coordination with each other. For example, a vacuum cleaner starts as soon as the drill is started. Ideally, the various functions can be controlled with the help of an app.

Via a mobile device, it is possible to download the usage and wear data, and as a result to optimally plan the maintenance cycles or, in the case of a rental device, to settle the accounts on the basis of actual usage.

Benefits

- ✓ Access to device data at any time.
- ✓ Contactless data access prevents the penetration of dust and water, extending device life.
- ✓ Installation of further systems, e.g. for localizing the location of the molds or sensors with fall detection. This data can be read out using a mobile app.

Communication Tool - Smartphone

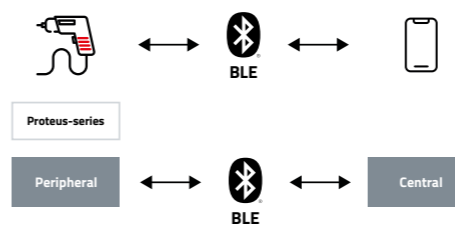

Communication Tool - Peripheral Devices

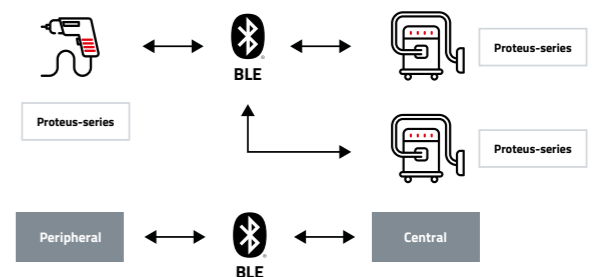

Communication Smartphone - Tool - Peripheral Devices

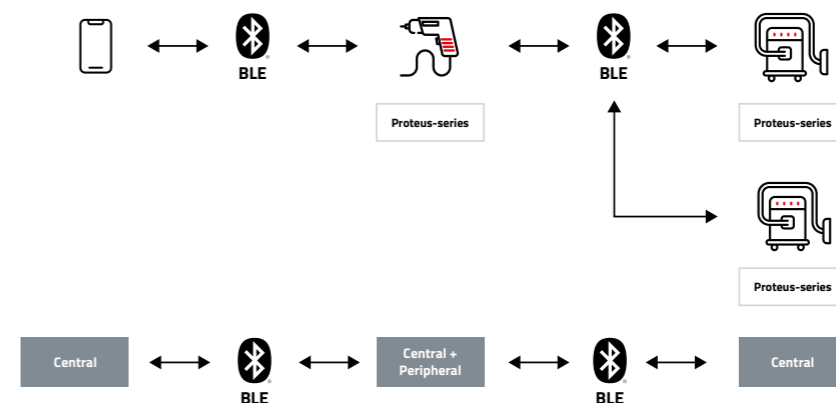

ACCELERATION

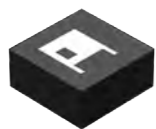

WSEN-ITDS

- 3 axis acceleration
- 14 bit output resolution
- ±2g, ±4g, ±8g, ±16g
- 2 x 2 x 0.7 mm

Sensing Acceleration for vandalism protection.

BLUETOOTH



Proteus-III

- Bluetooth® LE 5.1
- Nordic nRF52840
- 8 dBm output power
- 12 x 8 x 2 mm

Connection between the tools, which want to be used in Sync mode: Sync mode one master tool controls the other(s). Meaning, activating this tool via the tool trigger will activate the synchronized tool(s) as well.

HUMIDITY & TEMPERATURE

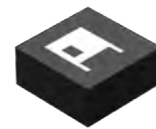

WSEN-HIDS

- 16 bit humidity and temperature output
- I²C and SPI interface
- 2 x 2 x 0.9 mm

Sensing Humidity & temperature of the environment to ensure the vacuum cleaner is used in right operating conditions.

SMART HELMET



WEARABLES – SMART HELMET

In the case of motorcycle accidents, it is of crucial importance to receive medical aid as soon as possible, as the collision might severely hurt internal organs. A smart helmet that can detect a crash and send an emergency alarm automatically could thus be a lifesaver.

Acceleration sensors and LTE mobile radio modules including localization (GNSS) by Würth Elektronik can be used to implement safety applications. In case the sensor system detects the movement pattern of a collision, an emergency call will automatically be sent or predefined persons could be contacted.

Benefits

A helmet which is able to communicate and to collect data can increase safety and comfort of the biker.

- ✓ The condition in the helmet can be measured via additional integrated sensors, for example temperature and humidity. The driver is alerted in time and thus protected from overheating.
- ✓ In addition, a communication interface for radio contact between driver and passenger can be implemented.



HUMIDITY & TEMPERATURE



WSEN-HIDS

- 16 bit humidity and temperature output
- I²C and SPI interface
- 2 x 2 x 0.9 mm

Measuring environmental conditions in the helmet to avoid overheat in summer time or wetness in the helmet due to leakage while significant rain.

ACCELERATION

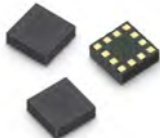

WSEN-ITDS

- 3 axis acceleration
- 14 bit output resolution
- ±2g, ±4g, ±8g, ±16g
- 2 x 2 x 0.7 mm

- Impact detection and initiating the radio module to setup an emergency call.
- Impact detection to gather information for the doctors for the grade of injury.
- Concussion detection

BLUETOOTH



Proteus-III

- Bluetooth® LE 5.1
- Nordic nRF52840
- 8 dBm output power
- 12 x 8 x 2 mm

Connection from helmet to mobile to download. Data from helmet like head movement, specific vibrations, etc.

CELLULAR



Adrastea-I

- LTE-NB.IoT / Cat.M1
- incl. GNSS
- 14 x 13 x 2 mm

Communication from Master Gateway at construction site to central server.

AUTOMATED GUIDED VEHICLES

SMART INDUSTRY – AUTOMATED GUIDED VEHICLES

Automatic Guided Vehicles (AGV) or Autonomous Mobile Robots (AMR) are vitally important for flexible intralogistics concepts. While GNSS can be used for navigation outdoors, robots in factories and warehouses need different orientation techniques.

Key factors for the navigation of AMRs are wireless communication and acceleration sensors for inertial navigation. Würth Electronic does not only offer sensor and radio modules but also supports various communication protocols. Orientation via anchor point antennas distributed on the factory or warehouse floor as well as transmission of orders and status updates can be realized, e.g. with Bluetooth, Wirepas Massive Routing Mesh, or WE-ProWare Flooding Mesh.

Benefits

Autonomous Mobile Robots – autonomous but well connected

- ✓ Communication with intralogistics vehicles can be realized over a variety of protocols - even proprietary solutions might prove to be a good solution.
- ✓ With wireless communication, all kinds of information can be shared, e.g. battery charge status, transport weight, or condition of wear parts.



PROPRIETARY



Tarvos-III

- 868 MHz
- RF Pad / PCB Antenna
- 14 dBm output power
- 27 x 17 x 3.8 mm

Sub-GHz radio communication in industrial environment offers reliability.

BLUETOOTH



Proteus-III

- Bluetooth® LE 5.1
- Nordic nRF52840
- 8 dBm output power
- 12 x 8 x 2 mm

Find a specific robot selected using the function "Direction Finding" to navigate the user to the tool.

ACCELERATION



WSEN-ITDS

- 3 axis acceleration
- 14 bit output resolution
- ±2g, ±4g, ±8g, ±16g
- 2 x 2 x 0.7 mm

Sensing movement or crash detection.

WIREPAS



Thetis-I

- Wirepas routing mesh protocol, 2.4 GHz
- +6 dBm output power
- 8 x 12 x 2 mm

Find a specific robot selected using Wirepas Positioning Engine.

CONSTRUCTION LIGHTING



SMART INDUSTRY – INTELLIGENT MOBILE CONSTRUCTION LIGHTING

Mobile lighting at construction sites, especially on expressways, pose a great risk to the workers, if these lights are shifted by unobservant road users. Sensors and a communication mesh provide additional safety.

The lamps and warning beacons for road construction have sensors for detecting strong movement impulses (impact) as well as for location detection. The lamps are interconnected via a mesh network and report any change in location within a centimeter range. This eliminates the need for regular checks along the site to ensure that all luminaires are still in the right position. The interconnection of the luminaires can be realized with a Wirepas Massive Routing Mesh, or WE-ProWare Flooding Mesh by Würth Elektronik.

Benefits

Smart lamps form a mesh and control their own position

- ✓ Luminaires equipped with GNSS and acceleration sensors report any change in location.
- ✓ Further advantages are the constant control of all functions, such as battery charge level, set brightness, or even environmental factors, e.g. temperature and humidity.



Central Master Gateway

The Central Master Gateway is equipped with WSEN-HIDS, WSEN-ITDS sensors, Thetis-I and Adrastea-I module.

HUMIDITY & TEMPERATURE

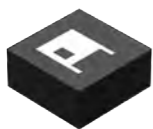

WSEN-HIDS

- 16 bit humidity and temperature output
- I²C and SPI interface
- 2 x 2 x 0.9 mm

Sensing Humidity & temperature to be aware of true local weather conditions.

GNSS



Erinome-I

- GPS, GLONASS, GALILEO, BEIDOU
- Integrated Antenna
- 18 x 18 x 6.4 mm

Localization of each single unit in case of theft or finding all owned units.

CELLULAR



Adrastea-I

- LTE-NB.IoT / Cat.M1
- incl. GNSS
- 14 x 13 x 2 mm

Communication from Master Gateway at construction site to central server.

ACCELERATION



WSEN-ITDS

- 3 axis acceleration
- 14 bit output resolution
- ±2g, ±4g, ±8g, ±16g
- 2 x 2 x 0.7 mm

Impact or location movement detection.

MESH



Thetis-I

- Wirepas routing mesh protocol, 2.4 GHz
- +6 dBm output power
- 8 x 12 x 2 mm

Connecting hundreds of devices to extend the range and without having the need to add LTE with recurring costs to each device

PROPRIETARY



Thyone-I

- 2.4 GHz
- Smart antenna selection
- 8 dBm output power
- 12 x 8 x 2 mm

Use a remote control connected wirelessly to the lamps and adjust settings.



INTELLIGENT COFFEE MACHINE

SMART HOME – INTELLIGENT COFFEE MACHINE

Coffee machines are popular and in daily use. Modern machines allow creative compositions of personalized coffee variants. At the same time, leasing models are increasingly based on so-called wet hours or actual consumption – smart solutions are required.

Humidity and temperature sensors as well as Bluetooth, WiFi and cellular modules from Würth Elektronik: Equipped in this way, a coffee machine can become a smart device. With the help of integrated humidity and temperature sensors, it is possible to control the machine's optimal functioning. A change of the machine's values indicates a malfunction, which means that the need for maintenance can be displayed at an early stage or reported directly to a service center. In leasing, a billing system can be realized through live data transfer to the cloud. Convenient for the user: By using a mobile app, each user can design his or her personal coffee and preset, e.g. the amount of coffee, milk, or water.

Benefits

Coffee pleasure with pay per use

- ✓ With the connection to the Internet, a technician can get access to usage and consumption data at any time. The supplier of coffee, cocoa powder or milk will be on site only if necessary. This saves resources and protects the environment.
- ✓ Personalized coffee preferences can be adjusted via smartphone.
- ✓ Instead of paying a fixed monthly fee, the customer only pays for actual consumption.

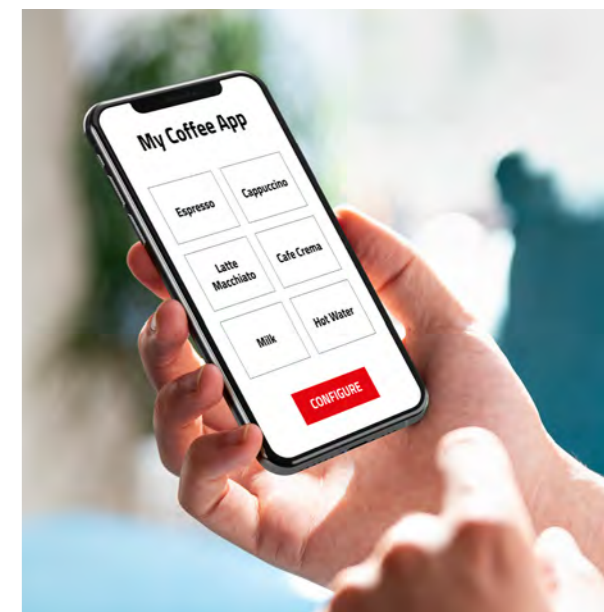

HUMIDITY & TEMPERATURE

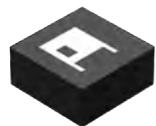

WSEN-HIDS

- 16 bit humidity and temperature output
- I²C and SPI interface
- 2 x 2 x 0.9 mm

Measuring Humidity and Temperature ensures an optimal function and taste.

BLUETOOTH



Proteus-III

- Bluetooth® LE 5.1
- Nordic nRF52840
- 8 dBm output power
- 12 x 8 x 2 mm

Connect to mobile App to preset your personal coffee or also as service interface for the technician.

WI-FI



Calypso

- IEEE 802.11 b/g/n, 2.4 GHz
- +18 dBm output power
- 19 x 27,5 x 4 mm

Live data transfer to the cloud platform within a Wi-Fi network.

CELLULAR



Adrastea-I

- LTE-NB.IoT / Cat.M1
- incl. GNSS
- 14 x 13 x 2 mm

Live data transfer to the cloud platform from anywhere.

WIRELESS ALARM SYSTEM



SMART HOME – WIRELESS ALARM SYSTEM









Older houses often have many weak points and are particularly vulnerable to burglary. However, retrofitting wired security devices is expensive and laborious. Manufacturers should therefore also offer radio-based alarm systems.

The development of retrofitable alarm systems with wireless technology depends on the right combination of radio technologies. For the control system, a connection to the Internet or to the mobile network is required. For connecting the sensors, radio frequencies in the sub-GHz and the 2.4 GHz range can be used, whereas both short and longer distances have to be bridged. Due to security reasons, the use of a long-established but not publicly known radio protocol, such as WE-ProWare by Würth Elektronik, is very advantageous. Intelligent sensor technology can detect the opening of windows or doors by measuring the change in barometric pressure, temperature or humidity and trigger a silent alarm.

Benefits

Proprietary radio protocol – a security advantage

- ✓ By intelligent combination and utilization of highly sensitive Würth Elektronik sensors, the opening of windows and doors can be detected without equipping the doors themselves with sensors.
- ✓ A wide range of Würth Elektronik radio modules allows variants for different spatial conditions.
- ✓ Arming and disarming of the alarm system can be executed via mobile devices if an internet connection via Wi-Fi or cellular module is established.

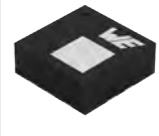
<p>PROPRIETARY</p>  <p>Tarvos-III</p> <ul style="list-style-type: none"> ▪ 868 MHz ▪ RF Pad / PCB Antenna ▪ 14 dBm output power ▪ 27 x 17 x 3.8 mm <p>The flooding mesh network of the WE-ProWare offers hundreds of alarm sensors to be connected secure and reliable.</p>	<p>PROPRIETARY</p>  <p>Thyone-I</p> <ul style="list-style-type: none"> ▪ 2.4 GHz ▪ Smart antenna selection ▪ 8 dBm output power ▪ 12 x 8 x 2 mm 	<p>WI-FI</p>  <p>Calypso</p> <ul style="list-style-type: none"> ▪ IEEE 802.11 b/g/n, 2.4 GHz ▪ +18 dBm output power ▪ 19 x 27,5 x 4 mm <p>Connecting the alarm system main console to the local Wi-Fi.</p>	<p>BLUETOOTH</p>  <p>Proteus-III</p> <ul style="list-style-type: none"> ▪ Bluetooth® LE 5.1 ▪ Nordic nRF52840 ▪ 8 dBm output power ▪ 12 x 8 x 2 mm <p>Accessing the alarm system settings from a mobile device in a short range.</p>	<p>CELLULAR</p>  <p>Adrastea-I</p> <ul style="list-style-type: none"> ▪ LTE-NB.IoT / Cat.M1 ▪ incl. GNSS ▪ 14 x 13 x 2 mm <p>Connecting the alarm system main console to the cellular network.</p>	<p>COMBINED</p>  <p>Setebos-I</p> <ul style="list-style-type: none"> ▪ Bluetooth® LE 5.1 & WE-ProWare 2.4 GHz ▪ 8 dBm output power ▪ 12 x 8 x 2 mm <p>Interconnecting all sensors through the WE-ProWare mesh, while offering mobile device access through Bluetooth in one device.</p>	<p>HUMIDITY & TEMPERATURE</p>  <p>WSEN-HIDS</p> <ul style="list-style-type: none"> ▪ 16 bit humidity and temperature output ▪ I²C and SPI interface ▪ 2 x 2 x 0.9 mm <p>Measuring local room temperature & humidity simultaneously.</p>	<p>ACCELERATION</p>  <p>WSEN-ITDS</p> <ul style="list-style-type: none"> ▪ 3 axis acceleration ▪ 14 bit output resolution ▪ ±2g, ±4g, ±8g, ±16g ▪ 2 x 2 x 0.7 mm <p>Recognizing movement of particular inventory like expensive art.</p>	<p>ABSOLUTE PRESSURE</p>  <p>WSEN-PADS</p> <ul style="list-style-type: none"> ▪ 26 – 126 kPa ▪ 260 – 1260 mbar ▪ 24 bit output resolution ▪ 2 x 2 x 0.8 mm <p>Measuring local room air pressure to monitor unforeseen window openings e.g. during a burglary.</p>
--	--	--	---	--	---	--	---	--

VANDALISM PROTECTION



SMART BUILDING – VANDALISM PROTECTION

Electronic devices such as motion detectors or video cameras for surveillance purposes which are installed in public or easily accessible areas are particularly at risk. Criminals will always try to destroy these devices first. Therefore, the intentional destruction of such electronic devices must be detected and reported immediately.

To be able to detect any tampering with a surveillance device, a sensitive 3D acceleration sensor and a radio module should be integrated. With the high-quality and power-saving components from Würth Elektronik, solutions can be developed that immediately sound the alarm, if someone tampers with a surveillance camera or motion detector.

Benefits

Protect the protecting devices

- ✓ An alarm quickly puts burglars into flight, and you are alerted yourself. With an internet connection, a direct emergency call can also be sent.
- ✓ In addition to the main function of motion detection or image recording, cost-effective secondary functions for surveillance are available, e.g. measurement of temperature, humidity and atmospheric pressure.



WI-FI



Calypso

- IEEE 802.11 b/g/n, 2.4 GHz
- +18 dBm output power
- 19 x 27,5 x 4 mm

Connect the camera to the internet for remote control functions.

HUMIDITY & TEMPERATURE

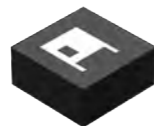

WSEN-HIDS

- 16 bit humidity and temperature output
- I²C and SPI interface
- 2 x 2 x 0.9 mm

Sensing Room or Outdoor temperature & Humidity.

ACCELERATION



WSEN-ITDS

- 3 axis acceleration
- 14 bit output resolution
- ±2g, ±4g, ±8g, ±16g
- 2 x 2 x 0.7 mm

Sensing Acceleration for vandalism protection. Tamper detection is the ability of a device to sense an active attack to the device and the threat of the attack should initiate an event (e.g. alarm, shutdown of the device).

IOT-WASHING MACHINE

SMART HOME – IOT-WASHING MACHINE

Smart homes need smart washing machines. Only a washing machine which is connected to the Internet of Things can be controlled remotely and switched on, for example, when there is a surplus of energy from the house's solar panels. Really smart machines come with excellent sensors.

Manufacturers who make their washing machines "intelligent" are opening up completely new business models. Machines that receive commands and provide feedback wirelessly can be sold as components of smart home concepts. If absolute pressure, differential pressure, temperature, and acceleration sensors are used to monitor the correct operation of a washing machine, leasing models can be developed, in which the customer only pays for actual use, for example in a laundromat or communal laundry. At the same time, the machine automatically reports the need for maintenance, for example, when its vibration behavior changes the material.

Benefits

Laundry becomes more sustainable

- ✓ Do not own, just use. Smart IoT machines are perfectly maintained machines – leasing becomes an attractive option for customers as well as for manufacturers.
- ✓ Robust and durable sensors from Würth Elektronik for long-lasting smart machines.
- ✓ Intelligent sensors, such as the differential pressure sensor, detect blocked filters.
- ✓ Personalized washing programs via mobile app and Bluetooth control.

ABSOLUTE PRESSURE

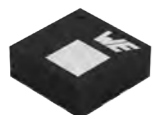

WSEN-PADS

- 26 – 126 kPa
- 260 – 1260 mbar
- 24 bit output resolution
- 2 x 2 x 0.8 mm

Measuring the water level through pressure in the washing machine.

HUMIDITY & TEMPERATURE

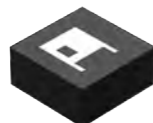

WSEN-HIDS

- 16 bit humidity and temperature output
- I²C and SPI interface
- 2 x 2 x 0.9 mm

Measuring humidity & temperature in the drum while drying process.

DIFFERENTIAL PRESSURE



WSEN-PDUS

- 15 bit digital output
- Analog & I²C interface
- 13.3 x 8 x 7.55 mm

Measuring the pre- and post-pressure of a filter to detect filter contamination.

TEMPERATURE



WSEN-TIDS

- Silicon based digital temperature sensor
- High accuracy (up to ±0.25 °C typ.)
- Fully calibrated 16 bit temperature output

Measuring the temperature in the drum while drying process.

ACCELERATION

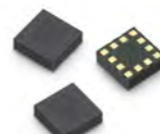

WSEN-ITDS

- 3 axis acceleration
- 14 bit output resolution
- ±2g, ±4g, ±8g, ±16g
- 2 x 2 x 0.7 mm

Monitoring and analyzing a possible unbalance of the washing drum.

BLUETOOTH



Proteus-III

- Bluetooth® LE 5.1
- Nordic nRF52840
- 8 dBm output power
- 12 x 8 x 2 mm

Bluetooth connectivity for mobile control or as technician interface.

WI-FI



Calypso

- IEEE 802.11 b/g/n, 2.4 GHz
- +18 dBm output power
- 19 x 27,5 x 4 mm

Connecting the washing machine to the Internet.



REPLACING LC DISPLAYS

MOBILE CONNECTIVITY – REPLACING LC DISPLAYS

LCDs are often used to indicate the status of devices, machines, and factory equipment. A little LCD Monitor on a machine looks elegant but it is not necessarily a sensible solution. LCDs age faster under harsh conditions and are wasteful in applications where they only need to be read a few times a year. Better: wireless data retrieval.

Anyone who provides machines or industrial plants with Liquid Crystal Displays should always consider whether such a display is necessary at this point, especially because every person who comes to the machine today carries a device with much higher display quality. With the industrial grade Bluetooth, WiFi and cellular modules from Würth Elektronik, it is easy to replace LC displays and output information to a mobile device app instead.

Benefits

Use your phone to check the machine

- ✓ Access is possible from anywhere, and system updates can be transmitted easily online by the manufacturer.
- ✓ Access to the data can be ensured via NFC or LE authentication.
- ✓ The use of cost-intensive displays can be avoided.



BLUETOOTH



Proteus-III

- Bluetooth® LE 5.1
- Nordic nRF52840
- 8 dBm output power
- 12 x 8 x 2 mm

Make use of the screen from a mobile device while saving the cost of an integrated LC display in the machine.

WI-FI



Calypso

- IEEE 802.11 b/g/n, 2.4 GHz
- +18 dBm output power
- 19 x 27,5 x 4 mm

Using the Wi-Fi direct function to use a responsive website instead of Bluetooth.

CELLULAR



Adrastea-I

- LTE-NB.IoT / Cat.M1
- incl. GNSS
- 14 x 13 x 2 mm

Connect an off-site machine to the internet through a cellular network. Save the LC display cost and lower the amount of possible damageable components.



REPLACING SWITCHES

MOBILE CONNECTIVITY – REPLACING “OLD FASHIONED” SWITCHES

Rotary switches on control units were a sensible solution for a long time. Furthermore, there was always the risk of unauthorized use. The more modern and secure approach: make the control unit addressable via radio. Or even make it an IoT device.

The ubiquity of smartphones and the widespread use of Wi-Fi networks open up the possibility of dispensing with rarely used switches on control units. With the slim Bluetooth LE and Wi-Fi modules from Würth Elektronik, you can make your control unit capable of wireless communication. The big advantage: Access can be restricted by secure authentication. And where a connection already exists, it can also be used to update the control unit, or for management via the Internet.

Benefits

Use your phone to activate the switch

- ✓ Avoid external changes of the control unit.
- ✓ Authentication necessary for changes.
- ✓ Mobile device can update the control unit's main functions.
- ✓ Wi-Fi: Cloud connectivity for status information, changes of settings from anywhere in the world etc..



BLUETOOTH



Proteus-III

- Bluetooth® LE 5.1
- Nordic nRF52840
- 8 dBm output power
- 12 x 8 x 2 mm

Replace the rotary switches with BT-LE and connect to Mobile device. Avoid external changes to the control unit. Advantages like Authentication needed for changes. Mobile device can update control unit main functions.

WI-FI



Calypso

- IEEE 802.11 b/g/n, 2.4 GHz
- +18 dBm output power
- 19 x 27,5 x 4 mm

Connect the control unit to Internet. Cloud connectivity for status informations, changes to the settings from anywhere in the world etc.



CONNECTED LIGHTING

SMART BUILDING – CONNECTED LIGHTING & ROOM CONDITIONING

Building automation is a great way to make indoor living more comfortable while saving energy. Lighting, heating, and ventilation systems only become really smart when they are adequately interconnected.

Sensors for humidity, temperature or CO² are needed to measure indoor air quality, as are connections to heating and ventilation systems, automatic window opening and shading systems. WiFi is suitable for connecting the gateway to the Internet for remote control, while mesh networks such as WE-ProWare are state of the art for interconnecting all sensors and actuators, light switches, and air conditioners.

Benefits

Mesh networks to control the ambience

- ✓ Smart lighting and air-conditioning serve our well-being.
- ✓ Connected lighting and room conditioning can be used to save energy.
- ✓ With a connection to the Internet, the system can additionally be managed by a mobile app.

COMBINED



Setebos-I

- Bluetooth® LE 5.1 & WE-ProWare 2.4 GHz
- 8 dBm output power
- 12 x 8 x 2 mm

Interconnecting all sensors through the WE-ProWare mesh, while offering mobile device access through Bluetooth in one device.

WI-FI



Calypso

- IEEE 802.11 b/g/n, 2.4 GHz
- +18 dBm output power
- 19 x 27,5 x 4 mm

Gateway connection from Mesh to the Internet.

HUMIDITY & TEMPERATURE

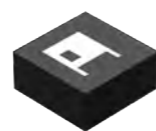

WSEN-HIDS

- 16 bit humidity and temperature output
- I²C and SPI interface
- 2 x 2 x 0.9 mm

Measuring local room temperature & humidity simultaneously.

TEMPERATURE



WSEN-TIDS

- Silicon based digital temperature sensor
- High accuracy (up to ±0.25 °C typ.)
- Fully calibrated 16 bit temperature output

Measuring room temperature.

ACCELERATION



WSEN-ITDS

- 3 axis acceleration
- 14 bit output resolution
- ±2g, ±4g, ±8g, ±16g
- 2 x 2 x 0.7 mm

Recognizing movement of particular inventory like expensive art.

ABSOLUTE PRESSURE

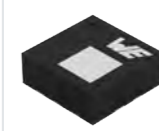

WSEN-PADS

- 26 – 126 kPa
- 260 – 1260 mbar
- 24 bit output resolution
- 2 x 2 x 0.8 mm

Measuring local room air pressure to monitor unforeseen window openings e.g. during a burglary.

INTELLIGENT IRRIGATION



CONNECTIVITY – INTELLIGENT IRRIGATION

A green garden is the jewel of any private or public building. But irrigation should be managed wisely. Especially in times of water scarcity, only as much water as necessary should be fed into the sprinkler system. With connectivity and sensors, sprinkler systems become intelligent.

A smart water pump detects when it is the right time to water the garden – based on wirelessly connected soil moisture sensors, the time of day, and maybe even from data about the availability of water resources like a cistern. By using several intelligent water pumps, gardens or parks can also be partially irrigated. Developers of irrigation systems should consider using humidity sensors and connectivity solutions like WE-ProWare Flooding Mesh or Wirepas Massive Routing Mesh to offer smart solutions which help their customers to save water.

Benefits

Mesh networks to control sprinklers

- ✓ An internet connection and cloud service can further enhance the benefits of a smart irrigation system.
- ✓ The user can analyze statistics on water consumption and watering times via a smartphone.



WI-FI



Calypso

- IEEE 802.11 b/g/n, 2.4 GHz
- +18 dBm output power
- 19 x 27,5 x 4 mm

Connect the central water pump to the Internet.

HUMIDITY & TEMPERATURE

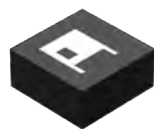

WSEN-HIDS

- 16 bit humidity and temperature output
- I²C and SPI interface
- 2 x 2 x 0.9 mm

Sensing outdoor humidity and temperature directly at the required planting bed.

ACCELERATION

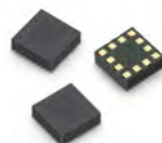

WSEN-ITDS

- 3 axis acceleration
- 14 bit output resolution
- ±2g, ±4g, ±8g, ±16g
- 2 x 2 x 0.7 mm

Sensing Acceleration for vandalism protection. Theft protection in case of movement.

MESH



Thetis-I

- Wirepas routing mesh protocol, 2.4 GHz
- +6 dBm output power
- 8 x 12 x 2 mm

Connecting hundreds of intelligent water sprinkler through a battery-saving routing mesh

KEYLESS ENTRY



KEYLESS ENTRY VIA BLUETOOTH AND AN APPROPRIATE APP

Who does not know it - forgot the key and locked out. Furthermore, they are uncomfortable in the pants or get lost in the handbag.

With the help of a unique assignment via Bluetooth and the appropriate app, such door opening systems are both secure and comfortable using a mobile device.

Benefits

- ✓ Fingerprints can also be stored or a numerical code can be used.
- ✓ The systems can also be protected by an acceleration sensor to trigger an alarm in the event of damage, for example.



BLUETOOTH



Proteus-I/-II

- Bluetooth® LE 4.2
- Bluetooth® LE 5.0
- Nordic nRF52832
- 3 dBm output power
- 11 x 8 x 2 mm

Connect to Mobile Device and connect Keys to Keypad.

ACCELERATION



WSEN-ITDS

- 3 axis acceleration
- 14 bit output resolution
- ±2g, ±4g, ±8g, ±16g
- 2 x 2 x 0.7 mm

Sensing Acceleration for vandalism protection, e.g. tamper detection

AIR FILTERS



CONNECTIVITY – AIR FILTERS

Equipping public buildings such as schools with air filtration devices to prevent infection, has burdened facility managers with an additional maintenance task. Manufacturers of such equipment would do well to simplify maintenance and operation – only a properly working air filter will protect.

The more air filters are in use, the more important remote maintenance becomes. Differential pressure and humidity sensors can be used to monitor the status of the filters. An internet gateway and a cloud application make remote maintenance convenient. Wi-Fi modules can be integrated to connect the devices to the gateway. A particularly flexible solution is an 868 MHz radio module with the proprietary radio protocol WE-ProWare. Additionally, this allows the bridging of longer distances than with Wi-Fi, if necessary.

Benefits

Proprietary network for remote maintenance

- ✓ WE-ProWare offers the possibility to customize functions by using simple commands.
- ✓ Unlike other sub-GHz standards, there are no license fees involved.

WI-FI



Calypso

- IEEE 802.11 b/g/n, 2.4 GHz
- +18 dBm output power
- 19 x 27,5 x 4 mm

Using the Wi-Fi direct function to use a responsive website instead of Bluetooth or simply connect the filter directly to the internet.

PROPRIETARY



Tarvos-III

- 868 MHz
- RF Pad / PCB Antenna
- 14 dBm output power
- 27 x 17 x 3.8 mm



Telesto-III

- 915 MHz
- RF Pad / PCB Antenna
- 14 dBm output power
- 27 x 17 x 3.8 mm

Connecting several Air filter in large building with each other through a mesh network. Sub GHz because of LongRange and sending data through walls.

HUMIDITY & TEMPERATURE

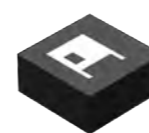

WSEN-HIDS

- 16 bit humidity and temperature output
- I²C and SPI interface
- 2 x 2 x 0.9 mm

Sensing Room temperature & Humidity.

ACCELERATION



WSEN-ITDS

- 3 axis acceleration
- 14 bit output resolution
- ±2g, ±4g, ±8g, ±16g
- 2 x 2 x 0.7 mm

Sensing Acceleration for vandalism protection, e.g. tamper detection.

DIFFERENTIAL PRESSURE



WSEN-PDUS

- 15 bit digital output
- Analog & I²C interface
- 13.3 x 8 x 7.55 mm

Measuring the pre- and post-pressure of a filter to detect filter contamination.

WEIGHTING SYSTEM



CONNECTIVITY – WIRELESS WHEELS WEIGHTING SYSTEM

Agriculture, biogas plants, haulers and industrial enterprises - there are many areas of application for a mobile axle load scale. When driving over it, the load on each single wheel of the vehicle is weighed separately. The measured values must then be merged.

In the case of mobile axle load scales, the weighing program calculates the total weight via the weighed axles. For this purpose, the individual scales must be linked by radio. Using a mesh network between the scales, the data can be collected and sent to a mobile device. Software in an mobile App can calculate the center of gravity of the load. Connecting the networked scales to the Internet and equipping them with GPS modules makes the management of the stock of these devices as simple as possible.

Benefits

Mesh-network of wheel scales

- ✓ WE-ProWare is ideal for individual mesh-networks of devices.
- ✓ Localization of scales and Internet-based management facilitates leasing business models.



WI-FI



Calypso

- IEEE 802.11 b/g/n, 2.4 GHz
- +18 dBm output power
- 19 x 27,5 x 4 mm

Connecting the scale gateway to the Internet.

COMBINED



Setebos-I

- Bluetooth® LE 5.1 & WE-ProWare 2.4 GHz
- 8 dBm output power
- 12 x 8 x 2 mm

Mobile App Connectivit Sending weight data through mobile App. Mesh between 4 scales for each wheel.

GNSS



Erinome-I

- GPS, GLONASS, GALILEO, BEIDOU
- Integrated Antenna
- 18 x 18 x 6.4 mm

Localization of each single scale.

ACCELERATION



WSEN-ITDS

- 3 axis acceleration
- 14 bit output resolution
- ±2g, ±4g, ±8g, ±16g
- 2 x 2 x 0.7 mm

Sensing Acceleration for vandalism protection or to avoid theft.

CONTAINER TRACKING

SMART INDUSTRY - CONTAINER TRACKING

Even during the pandemic, there were more than 150 Million containers shipped during 2021. It has never been as important to know, where your containers are, as it is at the moment! Due to shortages of materials, the bottle necks on asian harbors and during an pandemic, it is crucial to be aware of what happens with your products and where they are.

With the Wirepas Mesh Network communication protocol every device can be used as wireless router and can act as a repeater for other nodes. With WE sensors it's possible to monitor the environmental conditions of your parts just in time, any time. The GNSS modules allow to follow the tracked container and give you an exact location of your parts.

A network out of thousands of nodes, i.e. containers, increases the scale of the whole network and following the distance to bridge. Wirepas Massive offers a so called Positioning engine which is helpful to locate containers even inhouse.

Benefits

- ✓ Localization with GNSS
- ✓ Monitor the conditions with environmental sensors
- ✓ Build up a mesh Network with wirepas modules

MESH

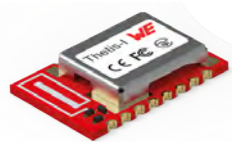

Thetis-I

- Wirepas routing mesh protocol, 2.4 GHz
- +6 dBm output power
- 8 x 12 x 2 mm

Building a huge network of sensor nodes with a robust wireless Mesh.

GNSS



Erinome-I

- GPS, GLONASS, GALILEO, BEIDOU
- Integrated Antenna
- 18 x 18 x 6.4 mm

Tracking the containers precise location.

HUMIDITY & TEMPERATURE

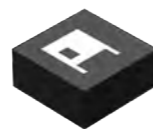

WSEN-HIDS

- 16 bit humidity and temperature output
- I²C and SPI interface
- 2 x 2 x 0.9 mm

Measuring container internal or outdoor temperature and humidity.

CELLULAR



Adrastea-I

- LTE-NB.IoT / Cat.M1
- incl. GNSS
- 14 x 13 x 2 mm

Connecting the container tracking to the cellular network and the location can be tracked wherever the container is on the globe.

ACCELERATION



WSEN-ITDS

- 3 axis acceleration
- 14 bit output resolution
- ±2g, ±4g, ±8g, ±16g
- 2 x 2 x 0.7 mm

Sensing Acceleration and impacts to have the information available when a container starts moving or in case a huge damage to the load has occurred.