

Project		Catalog #		Type	
Prepared by		Notes		Date	



Metalux

HB LED

High Efficacy 20" x 48" LED High Bay Efficiency Luminaire

Typical Applications

Industrial • Manufacturing

Interactive Menu

- Order Information [page 2](#)
- Photometric Data [page 4](#)
- Control Solutions [page 5](#)
- Connected Systems [page 5](#)
- Product Warranty

Product Certification



Product Features



Top Product Features

- Durable CRS and aluminum housing with white enamel finish
- High-Performance efficacy up to 170 lm/W
- LEDs available in 3500K, 4000K and 5000K at typical 85 CRI
- Rated for -40°C to 55°C ambient
- Lumen Maintenance – L84 @ 60,000 hours
- Options to meet Buy American and other domestic preference requirements

Dimensional and Mounting Details

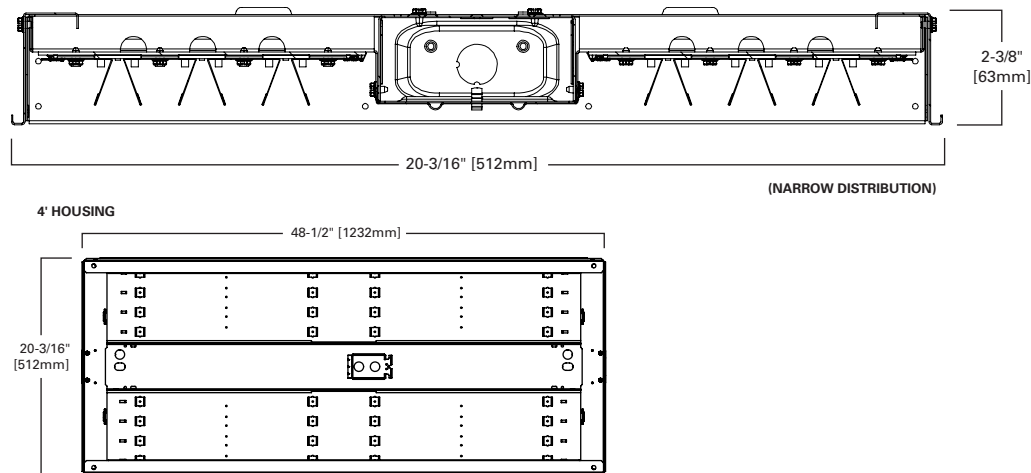

Order Information

SAMPLE ORDER NUMBER: **HBLEDD-LD5-18HE-W-UNV-L850-ED2-U** Includes V Hangers for rapid installation

Domestic Preferences	Series	Lamp Type	LED Lumen Output	Distribution	Shielding	Voltage	CCT	Emergency ⁽¹²⁾
[Blank] =Standard BAA =Buy American Act TAA =Trade Agreements Act	HBLEDD =LED High Bay Linear	LD5 =LED 5.0	12HE =12,000 Lumens 15HE =15,000 Lumens 18HE =18,000 Lumens 24HE =24,000 Lumens 30HE =30,000 Lumens 36HE =36,000 Lumens 48HE =48,000 Lumens 60HE =60,000 Lumens ⁽³⁾	N =Narrow (Aisle) W =Wide (General)	[Blank] =None A =Prismatic Acrylic Lens & Door frame ^{(4), (5), (6), (7)} CL =Clear Acrylic Lens & Door frame ^{(4), (6), (7)} A/WG =Acrylic Lens, Wireguard and Doorframe ^{(4), (5), (6), (7)} CL/WG =Clear Lens, Wireguard and Door frame ^{(4), (6), (7)} AI =Prismatic Acrylic Lens Insert ⁽⁴⁾ CLI =Clear Acrylic Lens Insert ⁽⁴⁾ FLI =Frosted Lens Insert ^{(4), (5)} POLY125/WG =Polycarbonate Lens, Wireguard and Door frame ^{(4), (6), (7)} POLY125 =Polycarbonate Lens and Door frame ^{(4), (6), (7)}	120V =120 Volt 277V =277 Volt 347V =347 Volt ⁽⁹⁾ 480V =480 Volt ^{(9), (10)} UNV =Universal Voltage 120-277 UNC =Universal Voltage 347/480 ⁽⁹⁾	70 CRI L735 =3500K L740 =4000K L750 =5000K 80 CRI L835 =3500K L840 =4000K L850 =5000K	EL7W =7-watt, 120V-277V emergency battery pack installed ⁽¹¹⁾ EL14W =14-watt 120V-277V emergency battery pack installed ⁽¹¹⁾ ETRD =Emergency Transfer Relay with dimming control ⁽¹³⁾
Notes (1) Only product configurations with these designated prefixes are built to be compliant with the Buy American Act of 1933 (BAA) or Trade Agreements Act of 1979 (TAA), respectively. Please refer to DOMESTIC PREFERENCES website for more information. Components shipped separately may be separately analyzed under domestic preference requirements.	Notes (2) DesignLights Consortium® Qualified and classified for both DLC Standard and DLC Premium, refer to www.designlights.org for details.	Notes (3) For 48,000 lumen package, CD option requires three drivers, ED option requires four.	Notes (4) Refer to ambient ratings chart for temperature requirements. (5) Not available with narrow distribution. (6) Integrated sensor not compatible with door frame. (7) Not available with 36HE, 48HE, and 60HE configurations.	Notes (8) Voltage must be specified when ordered with plugs, GTR or emergency driver. (9) Not available with dual switching. (10) Integral sensor works only with "CD" driver and is factory prewired to the driver for stand-alone control.	Notes (11) With integral test switch/indicator/laser test. For approximate delivered lumens multiply the lumens per watt of the desired fixture by the wattage of the emergency battery pack (100 lm/W x 7=700 lumens). IES-format photometry for luminaire under emergency operation available. (12) EM options available in 0°C - 40°C ambient. (13) Used to transfer fixture to secondary power during outage. Must be used in conjunction with UL 1008 device (provided by others). ETRD option only requires one relay when used on a dimming fixture. A maximum of two devices can be used on one product.			

Number of Relays	Driver Type	Number of Drivers	Options	Motion Sensors	Packaging	Accessories
1 =1 relay per driver non-dimming only 2 =2 relays per driver for dimming applications	CD =0-10V Dimming Driver ^{(15), (16)} ED =Electronic Fixed Output Driver ⁽¹⁵⁾ SLTD =Fifth Light DALI ^{(15), (16), (17)}	1 =1 Driver (12,000 and 15,000 lumen versions) 2 =2 Drivers (18,000, 24,000 and 30,000 lumen versions) 3 =3 Drivers (36,000 and 8,000 lumen CD option) ⁽¹⁸⁾ 4 =4 Drivers (48,000 and 60,000 lumen versions) ⁽¹⁸⁾	MP =Modular Power Receptacle (used for all Cord or Cord and Plug options) ⁽¹⁹⁾	MS =360° or 180° Motion Sensor Installed, (specify voltage) ⁽²⁰⁾ SVPD3 =integrated occupancy and daylight dimming sensor, 1200 sq. ft. coverage ^{(21), (22)} LWR =Enlightened Wireless Sensor system ^{(21), (22)} ZW-SWPD3 =Integrated Wavelinx Wireless Sensor, 1200 sq. ft. coverage ^{(21), (22)} OEPF010VMV =Occupancy Sensor with Integrated PhotoCell FSP-211/L7-U =PIR Occupancy Sensor with integral 0-10V dimming ^{(21), (22)} ZLD1Z =Leviton 120-277V PIR Occupancy Sensor with integral 0-10V Dimming ^{(21), (22), (23)}	U =Unit Pack PALC =Job Pack, in carton	HBL-SPM =Single Monopoint Hanger w/Hub HBL-SPM-S =Surface Mount Bracket FH-1 =Fixture Hook FL-1 =Fixture Loop Y-TOGGLE -_- 2PK =(2) Y-Toggle Cable Kits (Specify 10 or 30 for length in feet) HBAYC-CHAIN/SET/U =(2) V-Hook Hangers, 36" Chain Sets w/S-Hooks MPC3 =3' Modular Power Cord & Plug (Specify Voltage) MC6 =6' Modular Power Cord MPC6 =6' Modular Power Cord & Plug (Specify Voltage) MMS =360° or 180° Aisle Motion Sensor with Modular Power Receptacle (120-277V) WG/HBL6-4FT-B =Field Installable, Wireguard for HBLEDD ⁽²⁴⁾ ISHH-01 =Programming Remote for Integrated Sensor ISHH-02 =Personal Control Remote for Integrated Sensor SWPD3 =WaveLinx Sensor (for field installation into WaveLinx enabled fixture)
Notes (15) Lumen output will vary depending on dimming or fixed output drivers. Refer to IES files for delivered lumens. (16) Refer to ambient ratings chart for temperature requirements. (17) SLTD available with 12,000, 18,000, 24,000 and 36,000 lumen packages only.	Notes (18) For 48,000 lumen package, CD option requires three drivers, ED option requires four.	Notes (19) Requires use of MC or MPC cord accessories, specify voltage for plugs (MP).	Notes (20) When ordering MS option, specify as UNV (for 120 or 277V), 347 or 480V. (21) Integrated sensor not compatible with door frame. (22) Integral sensor works only with "CD" driver and is factory prewired to the driver for stand-alone control. (23) Configuration of basic and advanced features using the Leviton Smart Sensor App on any Bluetooth-enabled Android or iOS device.	Notes (24) Not available with lens insert options AI, CL and FLI or door frame options A, CL and POLY125. (25) Accessories sold separately will be separately analyzed under domestic preference requirements. Consult factory for further information.		

Product Specifications

Construction

- Constructed of channel and end plates with stiffening brackets and side rails
- Side rails are standard on all HBLEd products

Emergency Battery Options

- Optional 120-277V emergency battery available in 7W or 14W
- 90-minute backup period for code compliance
- Test switch with laser pointer and testing from floor feature for ease of use
- EZ Key feature prevents accidental discharge during construction
- Generator transfer options available

LED and Light Engine

- Drivers available in 120-277V and 347V
- Optional 0-10V dimming driver is available

Integrated Control Options

- Integral occupancy sensor available with coverage from 600 sqft up to 1250 sqft
- Maximum mounting height of 30'
- Provides occupancy and closed loop daylight harvesting

Finish

- Multistage, iron phosphate pretreatment
- Multistage cleaning cycle

Mounting

- Designed for suspension mounting
- Optional wire hook and chain set available
- Single monopoint mounting is available with SPM tong hanger

Frame/Shielding

- Optional door frame and lens assembly for added protection

Compliance

- IC rated for insulation contact
- cULus listed for damp locations -40°C to 55°C ambient environments
- Tested to IESNA LM-79 and LM-80
- Stated life tested to TM21 standards

Warranty

- Five-year warranty standard.

Modular F-Bay Power Supply Option

Cooper Lighting's F-Bay Modular Power Supply option is available for use with all F-Bay products. The modular power supply allows external fixture access for safe and easy servicing. There is no need to remove lamps or reflectors to disconnect fixture power with F-Bay Modular Power Supply. Access to the individual fixture's power supply allows servicing without turning off all the fixtures, disrupting occupants. F-Bay Modular Power Supply is a time saver in installation – **simply plug & power.**



1. Modular Power Supply Receptacle supplied mounted into fixture Access Plate
2. Modular Power Cord & Plugs in 120, 277, 347, & 480V configurations for easy plug & power into existing supply

No internal fixture access required for installation or disconnecting power

Modular Motion Sensor Option supplied with Mounting Box and Modular Power Supply Receptacle

Code Compliance

- UL/cUL Certified for Make/Break under load (UL2549)
- Meets NEC requirements for ballast disconnect (NEC 410.73G)
- Allows for addition of Occupancy Sensor without hard connections
- Receptacles complete with insulating/dust cap

Photometric Data

 [View IES files](#)

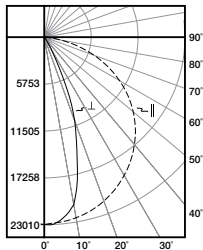

HBLED-LD5-24HE-N-UNV-L850-ED2-U
 Electronic Driver
 Linear LED 5000K
 Spacing criterion: (||) 1.27 x mounting height,
 (⊥) 0.62 x mounting height
 Lumens: 24414
 Input Watts: 146.3W
 Efficacy: 166.9 lm/W
 Test Report:
 HBLED-LD5-24HE-N-UNV-L850-ED2-U. IES

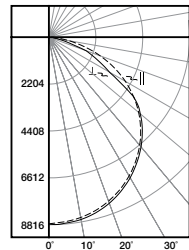

HBLED-LD5-24HE-W-UNV-L850-ED2-U
 Electronic Driver
 Linear LED 5000K
 Spacing criterion: (||) 1.28 x mounting height,
 (⊥) 1.29 x mounting height
 Lumens: 25352
 Input Watts: 146.3W
 Efficacy: 173.3 lm/W
 Test Report:
 HBLED-LD5-24HE-W-UNV-L850-ED2-U. IES

Energy and Performance Data

Catalog Number	5000K, 70CRI		
	Delivered Lumens	Watts	Efficacy (lm/W)
HBLED-LD5-12HE-W-UNV-L750	13,287	73	183
HBLED-LD5-15HE-W-UNV-L750	17,035	92	186
HBLED-LD5-18HE-W-UNV-L750	19,958	112	178
HBLED-LD5-24HE-W-UNV-L750	26,231	146	179
HBLED-LD5-30HE-W-UNV-L750	33,042	180	184
HBLED-LD5-36HE-W-UNV-L750	38,589	211	183
HBLED-LD5-48HE-W-UNV-L750	50,971	286	178
HBLED-LD5-60HE-W-UNV-L750	63,643	369	172

Catalog Number	5000K, 80CRI		
	Delivered Lumens	Watts	Efficacy (lm/W)
HBLED-LD5-12HE-W-UNV-L850	12,841	73	177
HBLED-LD5-15HE-W-UNV-L850	16,464	92	179
HBLED-LD5-18HE-W-UNV-L850	19,289	112	172
HBLED-LD5-24HE-W-UNV-L850	25,352	146	173
HBLED-LD5-30HE-W-UNV-L850	31,935	180	177
HBLED-LD5-36HE-W-UNV-L850	37,296	211	177
HBLED-LD5-48HE-W-UNV-L850	49,262	286	172
HBLED-LD5-60HE-W-UNV-L850	61,509	369	167

Lumen Maintenance

Ambient Temperature	TM-21 Lumen Maintenance (60,000 hours)	Theoretical L70 (hours)
55°C	> 84%	> 142,000

Shipping Data

Catalog No.	Wt.
HBLED-LD5-12HE	19 lbs.
HBLED-LD5-15HE	19 lbs.
HBLED-LD5-18HE	22 lbs.
HBLED-LD5-24HE	22 lbs.
HBLED-LD5-30HE	22 lbs.
HBLED-LD5-36HE	26 lbs.
HBLED-LD5-48HE	26 lbs.
HBLED-LD5-60HE	26 lbs.

Ambient Ratings

Lumen Package	Ambient Rated	Drivers			Lensed		EM
		ED	CD	5LTD	Inserts	Door frame	
HBLED-LD5-12HE	55°C	55°C	50°C	40°C	50°C	40°C	40°C
HBLED-LD5-15HE	55°C	55°C	50°C	40°C	50°C	40°C	40°C
HBLED-LD5-18HE	55°C	55°C	50°C	40°C	50°C	40°C	40°C
HBLED-LD5-24HE	55°C	55°C	50°C	40°C	50°C	40°C	40°C
HBLED-LD5-30HE	55°C	55°C	50°C	40°C	50°C	40°C	40°C
HBLED-LD5-36HE	55°C	55°C	45°C	35°C	45°C	-	40°C
HBLED-LD5-48HE	50°C	50°C	40°C	35°C	40°C	-	40°C
HBLED-LD5-60HE	45°C	45°C	40°C	35°C	40°C	-	40°C

Integrated Sensor

The HBLEDD with Integrated Sensor technology provides automatic energy savings without sacrificing performance. Traditionally, these types of energy savings required coordination between the luminaire and a lighting control system. The HBLEDD delivers superior lighting with integrated occupancy and daylighting controls.

Capture the benefits of traditional lighting controls, without complicated coverage planning or special wiring. Ideal for new construction or retrofit, the HBLEDD delivers automatic ON to an energy saving light level, while ensuring lighting is turned OFF when the space is unoccupied.

The integral daylight sensor reduces the need for special daylight zone planning. Each luminaire will automatically adjust the light level based on reflected light beneath the sensor in a closed loop method.

Occupied daylight light levels and unoccupied light levels can be adjusted using the integrated sensor programming remote (Catalog Number: ISHH-01). The integrated sensor personal remote (Catalog Number: ISHH-02) provides code compliant manual raise, lower, ON, OFF control.

The HBLEDD with Integrated Sensor is easy to install with no special wiring and ensures energy savings out-of-the-box with default control settings.

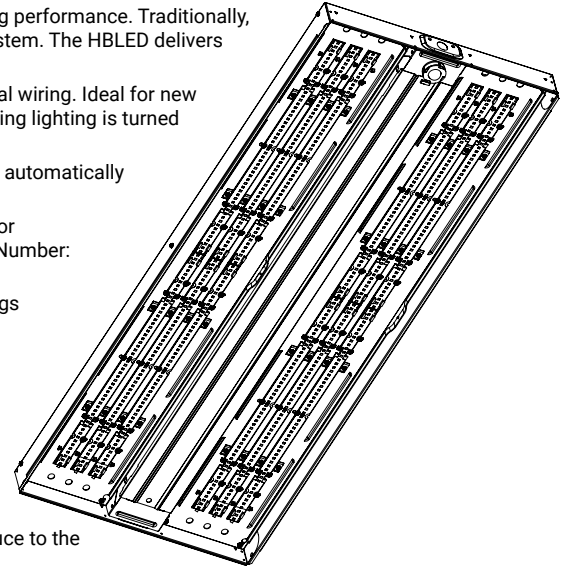

How it works:

- As the user enters the space controlled by the integral sensor, the lighting turns ON to the default daylight level.
- Lighting will remain at that the daylight level until the space is unoccupied. This will start the occupancy timeout period (default 20 minutes).
- If the space remains unoccupied for half of the timeout period, the lighting will automatically reduce to the Energy Saver light level. This adjustable light level is typically half of the occupied daylight level.
- At the end of the timeout period the lighting will go to the unoccupied light level. This adjustable light level uses the OFF default setting.

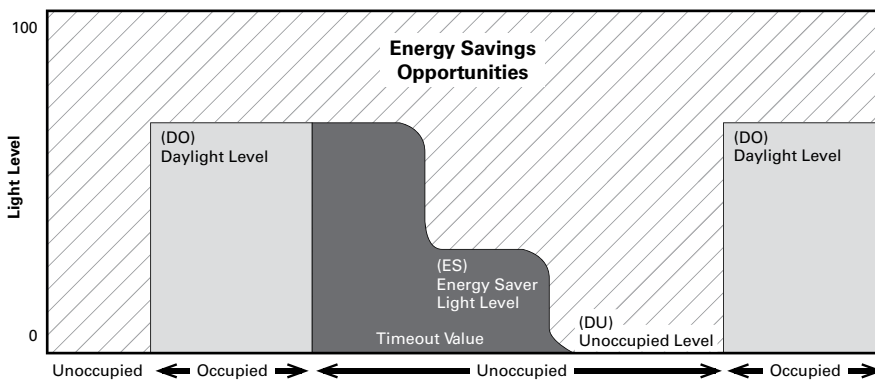

Default daylight harvesting set using 36,000 lumen unit at 30 ft. mounting height, 20 ft. spacing for 50 footcandles.

SVPD3 Coverage Pattern

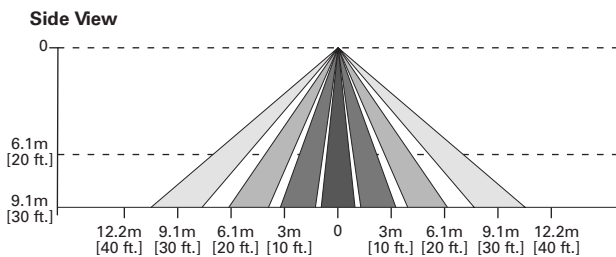

Optional Remote Controls

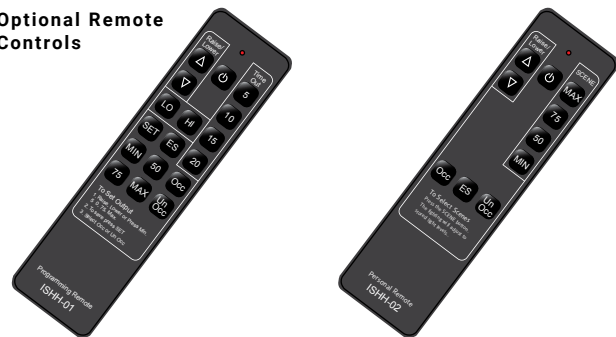

Control Systems

- WaveLinX
- DLVP
- iLumin Plus
- VividTune



Connected Systems
[CLICK HERE](#)