

Contender™ LED Luminaires

Enclosed and Gasketed Fixtures

NEC/CEC:

Class I, Division 2, Groups A,B,C,D
 Class I, Zone 2, AEx ec IIC ①
 Class II, Division 1, Groups E,F,G
 Zone 21, AEx tb IIIC ①

NEC/CEC:

Class II, Division 2, Groups F,G
 Class III
 Type 3R, 4, 4X
 IP66/67

NEC/CEC:

Simultaneous Exposure
 Suitable for Use in Wet Locations
 Marine Outside Type (Salt Water)
 American Bureau of Shipping (ABS) Certified

Applications

- Enclosed and gasketed fixtures suitable for use in:
 - A wide range of industrial, chemical processing and other areas where flammable gases, vapors and combustible dusts and fibers are present including simultaneous exposure
 - Marine and wet locations
 - Areas of low clearance, low ceiling heights or where fixture weights must be minimized
- Typical industries include:
 - Pulp and paper mills
 - Processing plants
 - Chemical plants
 - Petrochemical facilities
 - Oil refineries
 - Drilling rigs
 - Foundries
 - Waste treatment
 - Mining
 - Steel mills
- Typical applications include:
 - Walkways/catwalks
 - Stairwells
 - Grain elevators
 - Tunnels
 - Pipe racks
 - Offshore rigs
 - Vessel lighting
 - Cooling towers
 - Processing areas

Features

- Mounts directly to the following Crouse-Hinds™ † Champ® VMV mounting hoods:

Mounting Hoods	Model Number
Pendant	APM2, APM3
Flexible Pendant	HPM2
Ceiling	CM2, CM3
Wall	TWM2, TWM3
Quad	QM25
25° Stanchion	JM5
Straight Stanchion	PM5

- Compact light weight low profile design is suited for low mounting heights (less than 12 lbs).
- Customize to the application requirements with four different field replaceable globe options: clear and diffused polycarbonate, clear glass, or prismatic glass refractor.
- Three Correlated Color Temperatures (CCTs) for a wide variety of applications: Cool (5000K), Neutral (4000K) and Warm (3000K)
- Three light output levels for retrofit of HID fixtures up to 175 W.

Nominal Lumens ②	HID Equivalent	Model Number
3300	70-100W	VMV3LCG5BU
4400	100-150W	VMV4LCG5BU
5500	150-175W	VMV5LCG5BU



- Standard 6 kV surge protection.
- Ambient Temperature: BU: -40 °C to +65 °C (-40 °F to +149 °F)
 BH: -40 °C up to +65 °C (-40 °F up to +149 °F)
- Heavy duty, high temperature silicone rubber gaskets.
- Fixture life rated at 100,000 Hours with a calculated fixture life of 200,000 hours @ +25 °C (+77 °F).
- Field replaceable globes and IP66 rated LED driver.
- Rugged housing with superior thermal design translates to long luminaire life.
- Luminaire comes pre-wired with three conductors, approximately 12" long, of 14 AWG TEW wire from the IP68 watertight NPT hub at the top of the luminaire lid.
- Product can be configured with wirenuts or screw terminal blocks for ease of wiring.

Options

- Glass and Polycarbonate globe and glass refractor guards available, purchase separately.

Standard Materials

- Luminaire body: cast copperfree (4/10 of 1% max.) aluminum
- All hardware: stainless steel
- Globe: polycarbonate or glass
- Refractor: heat-resistant prismatic glass
- Glass globe guard: stainless steel wire
- Glass refractor guard: die cast aluminum
- Reflector: fiberglass reinforced white polyester

Standard Finishes

- Luminaire bodies and glass refractor guard: gray epoxy powder coat finish, electrostatically applied for complete uniform protection

NEC/CEC Certifications and Compliances

- UL Standard: UL 50E, Second Edition; UL 844, Thirteenth Edition; UL 1598, Third Edition; UL 1598A, First Edition; UL 8750, Second Edition;
- CSA Standard: C22.2 No 0-10; C22.2 No. 94.2-15; C22.2 No. E60598-1:16; C22.2 No. 137-M1981; C22.2 No. 250.0-.08; C22.2 No. 250.13-14; C22.2 No. 60529:16
- cCSAus Listed: Master contract 164460;| Certificate Number 70170001

DesignLights™ Consortium

- Check DLC QPL for current list of products.

① AEx rating is only applicable to product configurations with terminal block wiring option

② Nominal Lumen value for 5000K CCT, clear glass globe. Detailed lumen information is provided in tables.

† Crouse-Hinds is a registered trademarks of Cooper Crouse-Hinds.

Contender™ LED Luminaires

Enclosed and Gasketed Fixtures

NEC/CEC:

Class I, Division 2, Groups A,B,C,D
 Class I, Zone 2, AEx ec IIC ①
 Class II, Division 1, Groups E,F,G
 Zone 21, AEx tb IIIC ①

NEC/CEC:

Class II, Division 2, Groups F,G
 Class III
 Type 3R, 4, 4X
 IP66/67

NEC/CEC:

Simultaneous Exposure
 Suitable for Use in Wet Locations
 Marine Outside Type (Salt Water)
 American Bureau of Shipping (ABS) Certified

Illustrated Features

Heatsink

Reliable heat transfer via the cast, epoxy powder coat aluminum body. Provides maximum heat dissipation from the LED assembly to the outside environment.

Driver Assembly

IP66 rated driver utilizes non-sparking components avoiding the ignition of gases or vapors that may be present.

Globe Gaskets

Silicone rubber gaskets seal out moisture, dirt and dust. Stays flexible, withstands extreme temperatures. Closure design assures uniform gasket compression.

Watertight

Watertight IP68 rated bushing where cord enters luminaire hood ensures no water will enter the luminaire from the conduit through the mounting hood.



Epoxy Finish

Fixture housing, hoods and guards are copperfree aluminum with triple protection epoxy powder coat finish.

“Safety” Cable

Safety cable option threads through the fixture housing for additional safety.



Electrical Protection

External Grounding provisions for additional safety.

Angeled Reflector and Visor

Angeled reflector is thick, tough fiberglass reinforced white polyester. Visor is aluminum with electrostatically applied, gray epoxy powder coat finish. Quickly attach either accessory to luminaire with furnished stainless steel screws.

Wiring Flexibility

Choose between wire nuts and screw terminal blocks to suit end user wiring preferences. Terminal blocks support UL/CSA 24 to 12 AWG wire.

Prismatic Refractors

Heat-resistant refractor threads directly into fixture housing and seal against a high-temperature silicone rubber gasket.

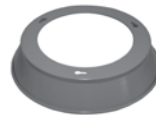

① AEx rating is only applicable to product configurations with terminal block wiring option

Contender™ LED Luminaires

Enclosed and Gasketed Fixtures

NEC/CEC:
 Class I, Division 2, Groups A,B,C,D
 Class I, Zone 2, AEx ec IIC ①
 Class II, Division 1, Groups E,F,G
 Zone 21, AEx tb IIIC ①

NEC/CEC:
 Class II, Division 2, Groups F,G
 Class III
 Type 3R, 4, 4X
 IP66/67

NEC/CEC:
 Simultaneous Exposure
 Suitable for Use in Wet Locations
 Marine Outside Type (Salt Water)
 American Bureau of Shipping (ABS) Certified

Contender™ LED Family Tree

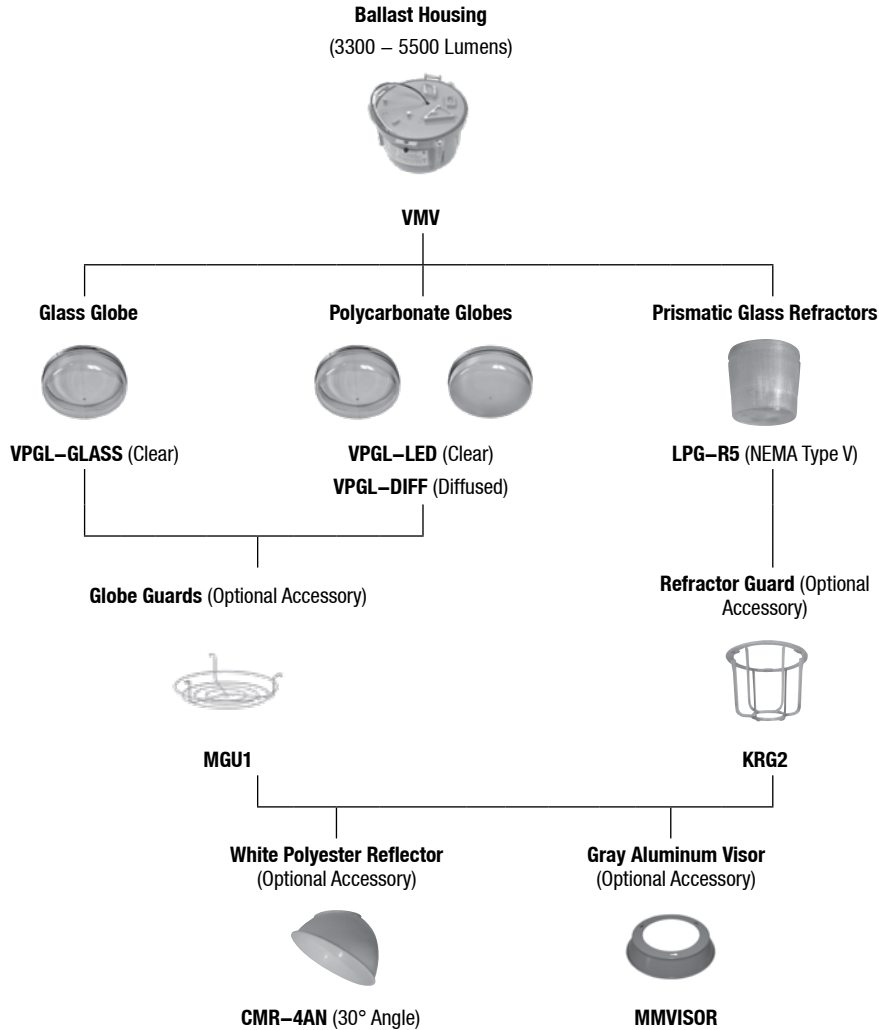

① AEx rating is only applicable to product configurations with terminal block wiring option

Contender™ LED Luminaires

Enclosed and Gasketed Fixtures

NEC/CEC:

Class I, Division 2, Groups A,B,C,D
 Class I, Zone 2, AEx ec IIC ①
 Class II, Division 1, Groups E,F,G
 Zone 21, AEx tb IIIC ①

NEC/CEC:

Class II, Division 2, Groups F,G
 Class III
 Type 3R, 4, 4X
 IP66/67

NEC/CEC:

Simultaneous Exposure
 Suitable for Use in Wet Locations
 Marine Outside Type (Salt Water)
 American Bureau of Shipping (ABS) Certified

Order using catalog numbering guides below or select catalog number from tables on following pages.

**Catalog Numbering Guide
 For Hazardous Locations:**

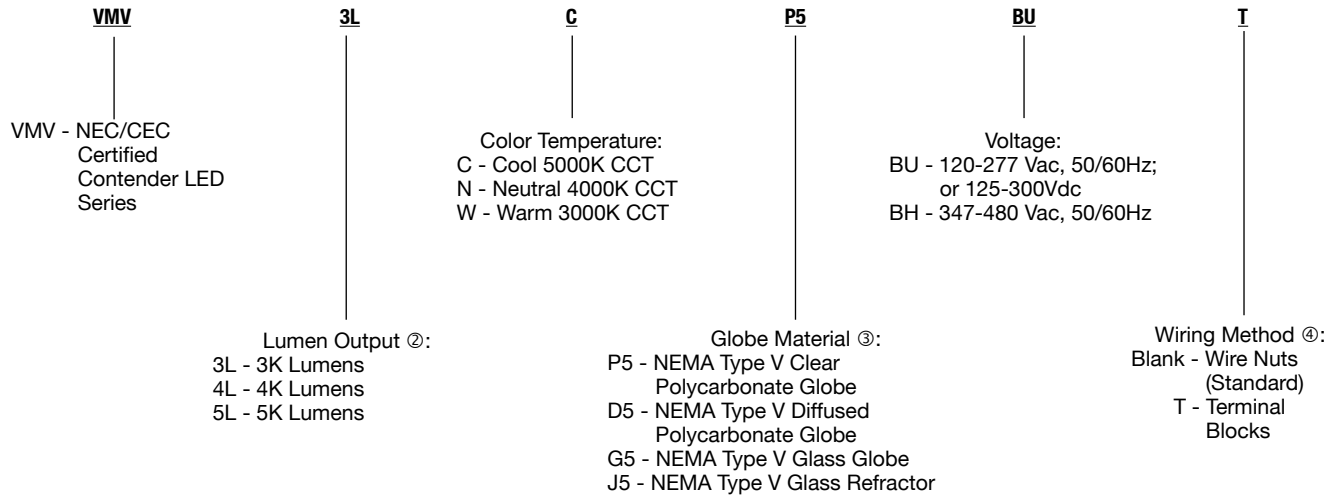

① AEx rating is only applicable to product configurations with terminal block wiring option

② For specific lumen output information, see Lumen Output table.

③ Guards for the glass refractor and globes are ordered separately. See the Accessories section for more information.

④ Terminal block wiring option is only available with BU voltage configuration.

Contender™ LED Luminaires

Enclosed and Gasketed Fixtures

NEC/CEC:

Class I, Division 2, Groups A,B,C,D
 Class I, Zone 2, AEx ec IIC ①
 Class II, Division 1, Groups E,F,G
 Zone 21, AEx tb IIIC ①

NEC/CEC:

Class II, Division 2, Groups F,G
 Class III
 Type 3R, 4, 4X
 IP66/67

NEC/CEC:

Simultaneous Exposure
 Suitable for Use in Wet Locations
 Marine Outside Type (Salt Water)
 American Bureau of Shipping (ABS) Certified

NEC/CEC Temperature Codes

Model	Type	Ambient Temperature °C (°F)	Supply Wire Temperature °C (°F)	Gas		Class II, Division 1, Groups E, F and G ③	Dust		Gas/Dust Simultaneous ② Class I, Division 2/ Class II, Division 1
				Class I, Division 2 Groups A, B, C, D ②	Class I, Zone 2 Group AEx ec IIC		Zone 20, Group IIIC,	Zone 21, AEx tb IIIC	
	LED	40 (104)	90 (194)	T4A	T4	T6	T6	T85°C	T4A
VMV3L	LED	55 (131)	90 (194)	T4	T4	T6	T6	T85°C	T4
	LED	65 (149)	90 (194)	T4	T4	T5	T5	T100°C	T4
	LED	40 (104)	90 (194)	T4A	T4	T6	T6	T85°C	T4A
VMV4L	LED	55 (131)	90 (194)	T4	T4	T6	T6	T85°C	T4
	LED	65 (149)	90 (194)	T4	T4	T5	T5	T100°C	T4
	LED	40 (104)	90 (194)	T4A	T4	T6	T6	T85°C	T4A
VMV5L	LED	55 (131)	90 (194)	T4	T4	T6	T6	T85°C	T4
	LED	65 (149)	90 (194)	T4	T4	T5	T5	T100°C	T4

“T” Numbers Represent the Maximum Internal Temperature ② or Maximum Surface Temperature ③

“T” #	NEC/CEC															
	T1	350	325	T2	T2A	T2B	T2C	T2D	T3	T3A	T3B	T3C	T4	T4A	T5	T6
Temp. Range °C (°F)	351-450 (664-842)	326-350 (619-662)	301-325 (574-617)	281-300 (538-572)	261-280 (502-536)	231-260 (448-500)	216-230 (421-446)	201-215 (394-419)	181-200 (358-392)	166-180 (331-356)	161-165 (322-329)	136-160 (277-320)	121-135 (250-275)	101-120 (214-248)	86-100 (187-212)	85 (185)

① AEx rating is only applicable to product configurations with terminal block wiring option.

② T numbers represent the maximum internal temperature for Class I, Division 2 and Class I, Zone 2 locations designated by the NEC.

③ T numbers represent the maximum surface temperature under a dust blanket for Class II, Division 1 as designated by the NEC.

Contender™ LED Luminaires

Enclosed and Gasketed Fixtures

NEC/CEC:

Class I, Division 2, Groups A,B,C,D
 Class I, Zone 2, AEx ec IIC ①
 Class II, Division 1, Groups E,F,G
 Zone 21, AEx tb IIIC ①

NEC/CEC:

Class II, Division 2, Groups F,G
 Class III
 Type 3R, 4, 4X
 IP66/67

NEC/CEC:

Simultaneous Exposure
 Suitable for Use in Wet Locations
 Marine Outside Type (Salt Water)
 American Bureau of Shipping (ABS) Certified

Lumen Values Table ②③

Model	Lumens ②			Type V Prismatic Glass Refractor	CRI ③	Color Temp CCT	Equivalent HID Luminaire
	Polycarbonate Clear Globe	Polycarbonate Diffused Globe	Glass Clear Globe				
NEMA Type V							
VMV3L	3200	3100	3300	3000			70-100W
VMV4L	4200	4100	4400	4000	>70	5000K	100-150W
VMV5L	5300	5150	5500	4900			150-175W
NEMA Type V							
VMV3L	3000	2900	3100	2800			70-100W
VMV4L	4000	3900	4200	3800	>70	4000K	100-150W
VMV5L	5000	4900	5200	4650			150-175W
NEMA Type V							
VMV3L	3000	2900	3100	2800			70-100W
VMV4L	3900	3800	4100	3700	>70	3000K	100-150W
VMV5L	4900	4800	5100	4600			150-175W

① AEx rating is only applicable to product configurations with terminal block wiring option.
 ② All lumen values are typical (tolerance +/- 10%).
 ③ 70 minimum.

Contender™ LED Luminaires

Enclosed and Gasketed Fixtures

NEC/CEC:
 Class I, Division 2, Groups A,B,C,D
 Class I, Zone 2, AEx ec IIC ①
 Class II, Division 1, Groups E,F,G
 Zone 21, AEx tb IIIC ①

NEC/CEC:
 Class II, Division 2, Groups F,G
 Class III
 Type 3R, 4, 4X
 IP66/67

NEC/CEC:
 Simultaneous Exposure
 Suitable for Use in Wet Locations
 Marine Outside Type (Salt Water)
 American Bureau of Shipping (ABS) Certified

Electrical Ratings ②

Model	Voltage	Input Power (Watts)	Input Current (Amps)	Power Factor (PF)	Total Harmonic Distortion (THD)
VMV3L	120 Vac	28.0	.28	> .94	< 20%
	277 Vac	28.0	.13		
	125 Vdc	27.2	.24	—	
	300 Vdc	27.2	.09		
	347 Vac	29.7	.10	> .93	
	480 Vac	29.8	.06		
VMV4L	120 Vac	38.0	.38	> .96	< 20%
	277 Vac	38.0	.16		
	125 Vdc	37.4	.32	—	
	300 Vdc	39.0	.13		
	347 Vac	39.6	.13	> .96	
	480 Vac	39.7	.08		
VMV5L	120 Vac	48.0	.48	> .97	< 20%
	277 Vac	48.0	.20		
	125 Vdc	50.2	.40	—	
	300 Vdc	48.0	.16		
	347 Vac	50.5	.16	> .97	
	480 Vac	50.4	.10		

① AEx rating is only applicable to product configurations with terminal block wiring option.

② All values are typical (tolerance +/-10%).

Contender™ LED Luminaires

Enclosed and Gasketed Fixtures

NEC/CEC:
 Class I, Division 2, Groups A,B,C,D
 Class I, Zone 2, AEx ec IIC ①
 Class II, Division 1, Groups E,F,G
 Zone 21, AEx tb IIIC ①

NEC/CEC:
 Class II, Division 2, Groups F,G
 Class III
 Type 3R, 4, 4X
 IP66/67





NEC/CEC:
 Simultaneous Exposure
 Suitable for Use in Wet Locations
 Marine Outside Type (Salt Water)
 American Bureau of Shipping (ABS) Certified

Fixture Unit — Ballast Body and Globe or Refractor



Lumen Level	LED Wattage	Light Level Equivalent	NEMA Type	Catalog Number ②			
				Polycarbonate Globe ②③④	Polycarbonate Diffused Globe ②③④	Glass Globe ②③④	With Type V Glass Refractor ②③④
NEC/CEC Certified Fixture Housing - For Hazardous Locations							
3K	28	70-100W HPS	Type V	VMV3LCP5	VMV3LCD5	VMV3LCG5	VMV3LCJ5
4K	38	100-150W HPS	Type V	VMV4LCP5	VMV4LCD5	VMV4LCG5	VMV4LCJ5
5K	48	150-175W HPS	Type V	VMV5LCP5	VMV5LCD5	VMV5LCG5	VMV5LCJ5

Replacement Parts

	Description	Catalog Number
Globes and Gaskets		
	Clear Globe (polycarbonate)	VPGL-LED
	Diffused Globe (polycarbonate)	VPGL-DIFF
	Glass Globe	VPGL-GLASS
Light Distribution		Catalog Number
	NEMA Type V	LPG-R5
Closed Prismatic Glass Refractors — All Heat-Resistant		
Glass Refractor		

① AEx rating is only applicable to product configurations with terminal block wiring option.
 ② For 120-277 Vac, use suffix **-BU**. For 347-480 Vac, use suffix **-BH**.
 ③ Guards are available for fixtures with glass globe or refractor. See following pages for accessory ordering information.
 ④ Correlated Color Temperature (CCT) indicated by C, N or W; C = Cool, 5000K CCT, N = Neutral, 4000K CCT, W = Warm, 3000K CCT. Example: **VMV5LCD5BU**

Contender™ LED Luminaires

Enclosed and Gasketed Fixtures

NEC/CEC:

Class I, Division 2, Groups A,B,C,D
 Class I, Zone 2, AEx ec IIC ①
 Class II, Division 1, Groups E,F,G
 Zone 21, AEx tb IIIC ①

NEC/CEC:

Class II, Division 2, Groups F,G
 Class III
 Type 3R, 4, 4X
 IP66/67

NEC/CEC:

Simultaneous Exposure
 Suitable for Use in Wet Locations
 Marine Outside Type (Salt Water)
 American Bureau of Shipping (ABS) Certified

Accessories

	Description	Catalog Number
--	-------------	----------------

White Polyester Reflectors



30° Angle

30° Angle

CMR-4AN

Guards



Glass Globe Guard



Refractor Guard

Glass Globe Guard

MGU1

Refractor Guard

KRG2

Safety Cable



Stainless steel.

LEDSC

Visor



Electrostatically applied gray epoxy powder coat finish on Aluminum Visor

MMVISOR

Replacement Drivers

	Voltage	Driver Wattage	Luminaire Model	Constant Current Settings	Catalog Number
	BU	50 Watt	VMV3L	720mA	APMS050C135UD72
	BH			720mA	APMS050C135HD72
	BU	50 Watt	VMV4L	1000mA	APMS050C135UD10
	BH			1000mA	APMS050C135HD10
	BU	50 Watt	VMV5L	1300mA	APMS050C135UD13
	BH			1300mA	APMS050C135HD13

Contender™ LED Low Profile Fixture and Globe Weights

Description	Weight kg (lb)
Fixture Unit (with polycarbonate globe)	5.30 (11.80)
Clear Glass Globe	0.88 (1.95)
Clear and Diffused Polycarbonate Globe	0.23 (0.50)
Prismatic Glass Refractor	2.30 (5.10)

① AEx rating is only applicable to product configurations with terminal block wiring option.

Contender™ LED Luminaires

Enclosed and Gasketed Fixtures

NEC/CEC:

Class I, Division 2, Groups A,B,C,D
 Class I, Zone 2, AEx ec IIC ①
 Class II, Division 1, Groups E,F,G
 Zone 21, AEx tb IIIC ①

NEC/CEC:

Class II, Division 2, Groups F,G
 Class III
 Type 3R, 4, 4X
 IP66/67

NEC/CEC:

Simultaneous Exposure
 Suitable for Use in Wet Locations
 Marine Outside Type (Salt Water)
 American Bureau of Shipping (ABS) Certified

Dimensions in Millimeters (Inches)

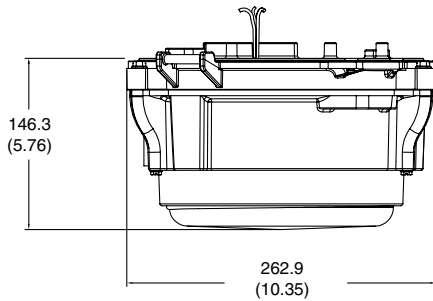

Clear/Diffused/Glass Globes

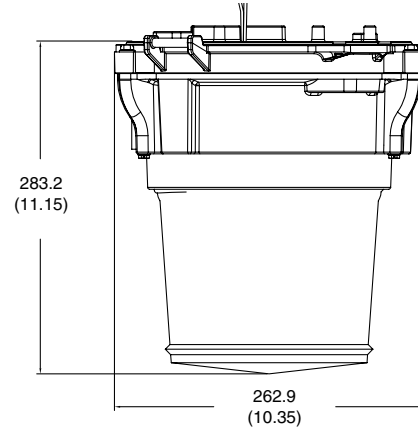

Closed Prismatic Glass Refractor

APPLETON™

LED/AREA: NEC/CEC, ATEX/IECEx ENCLOSED AND GASKETED

① AEx rating is only applicable to product configurations with terminal block wiring option.

Contender™ LED Luminaires

Enclosed and Gasketed Fixtures

NEC/CEC:

Class I, Division 2, Groups A,B,C,D
 Class I, Zone 2, AEx ec IIC ①
 Class II, Division 1, Groups E,F,G
 Zone 21, AEx tb IIIC ①

NEC/CEC:

Class II, Division 2, Groups F,G
 Class III
 Type 3R, 4, 4X
 IP66/67

NEC/CEC:

Simultaneous Exposure
 Suitable for Use in Wet Locations
 Marine Outside Type (Salt Water)
 American Bureau of Shipping (ABS) Certified

Photometric Data — DATA SHOWN IS ABSOLUTE

Type V, Clear Polycarbonate 5000K CCT

REPORT NUMBER: VMV3LCP5BU

Luminaire Lumens 3,198

POLAR CANDELA DISTRIBUTION

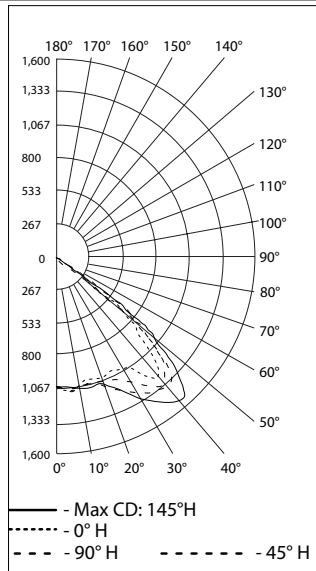

ISOFOOT CANDLE PLOT

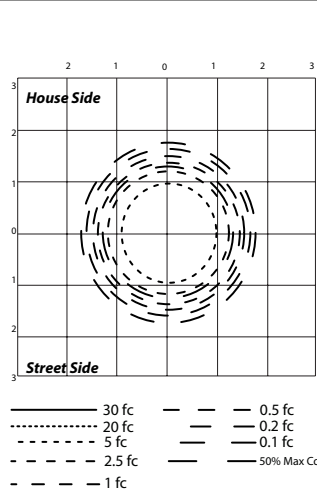

ZONAL LUMEN SUMMARY

Zone	Lumens	% Luminaire
0-30	932.7	29.2%
0-40	1,750.7	54.7%
0-60	3,144.3	98.3%
60-90	48.0	1.5%
70-100	17.6	0.6%
90-120	4.8	0.2%
0-90	3,192.3	99.8%
90-180	5.7	0.2%
0-180	3,198.0	100%

LUMENS PER ZONE

Zone	Lumens	% Total	Zone	Lumens	% Total
0-10	102.0	3.2%	90-100	1.9	0.1%
10-20	302.3	9.5%	100-110	1.9	0.1%
20-30	528.5	16.5%	110-120	1.0	0%
30-40	817.9	25.6%	120-130	0.8	0%
40-50	969.4	30.3%	130-140	0.0	0%
50-60	424.2	13.3%	140-150	0.0	0%
60-70	32.3	1.0%	150-160	0.0	0%
70-80	10.3	0.3%	160-170	0.0	0%
80-90	5.4	0.2%	170-180	0.0	0%

Type V, Clear Polycarbonate 5000K CCT

REPORT NUMBER: VMV3LCD5BU

Luminaire Lumens 3,103

POLAR CANDELA DISTRIBUTION

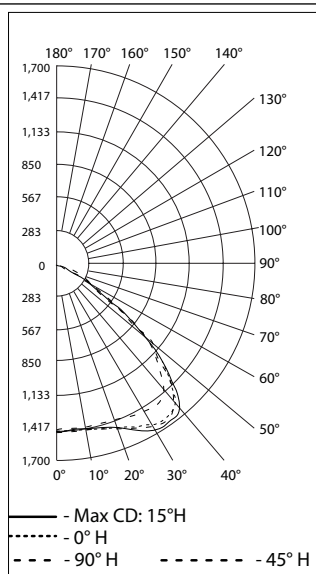

ISOFOOT CANDLE PLOT

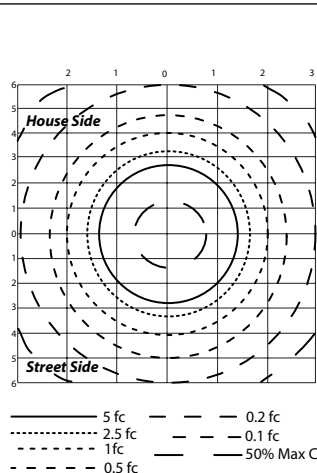

ZONAL LUMEN SUMMARY

Zone	Lumens	% Luminaire
0-30	903.1	29.1%
0-40	1,609.3	51.9%
0-60	2,795.0	90.1%
60-90	283.4	9.1%
70-100	107.9	3.5%
90-120	24.0	0.8%
0-90	3,078.4	99.2%
90-180	25.3	0.8%
0-180	3,103.7	100%

LUMENS PER ZONE

Zone	Lumens	% Total	Zone	Lumens	% Total
0-10	100.3	3.2%	90-100	9.0	0.3%
10-20	298.2	9.6%	100-110	10.7	0.3%
20-30	504.6	16.3%	110-120	4.3	0.1%
30-40	706.2	22.8%	120-130	1.2	0%
40-50	735.2	23.7%	130-140	0.1	0%
50-60	450.5	14.5%	140-150	0.0	0%
60-70	184.5	5.9%	150-160	0.0	0%
70-80	75.4	2.4%	160-170	0.0	0%
80-90	23.5	0.8%	170-180	0.0	0%

① AEx rating is only applicable to product configurations with terminal block wiring option.

Contender™ LED Luminaires

Enclosed and Gasketed Fixtures

NEC/CEC:

Class I, Division 2, Groups A,B,C,D
 Class I, Zone 2, AEx ec IIC ①
 Class II, Division 1, Groups E,F,G
 Zone 21, AEx tb IIIC ①

NEC/CEC:

Class II, Division 2, Groups F,G
 Class III
 Type 3R, 4, 4X
 IP66/67

NEC/CEC:

Simultaneous Exposure
 Suitable for Use in Wet Locations
 Marine Outside Type (Salt Water)
 American Bureau of Shipping (ABS) Certified

Photometric Data — DATA SHOWN IS ABSOLUTE

Type V, Clear Polycarbonate 5000K CCT
 REPORT NUMBER: VMV3LCG5BU

Luminaire Lumens 3,334

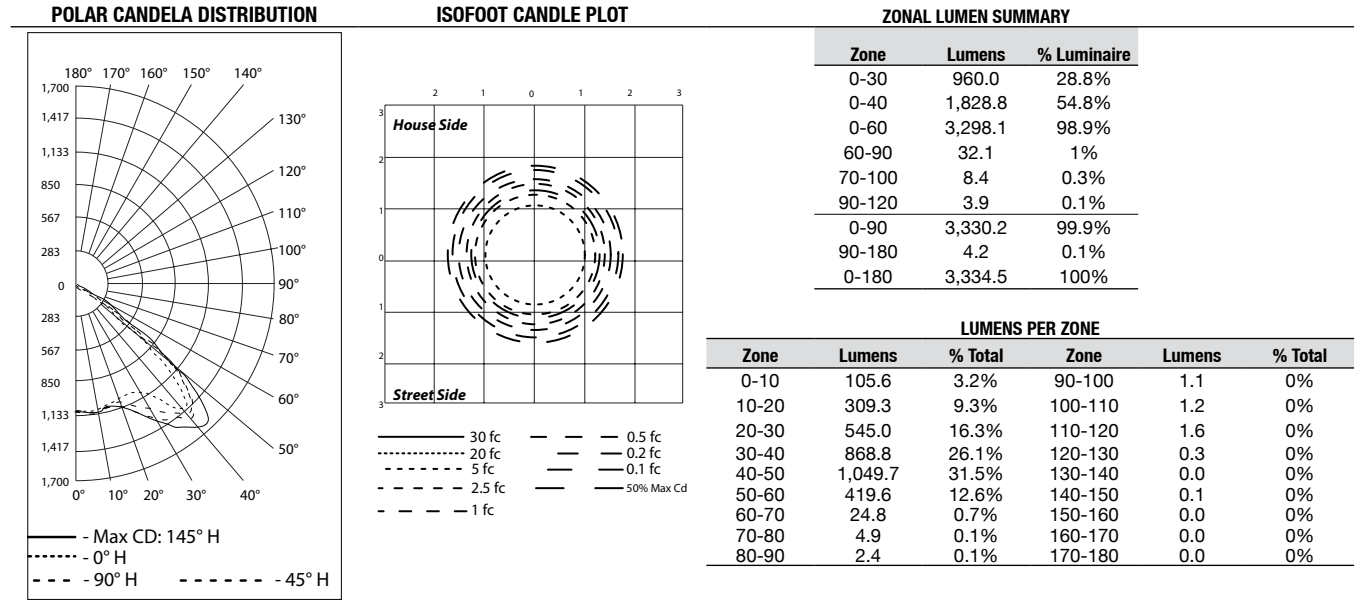

Type V, Clear Polycarbonate 5000K CCT
 REPORT NUMBER: VMV3LCJ5BU

Luminaire Lumens 3,020

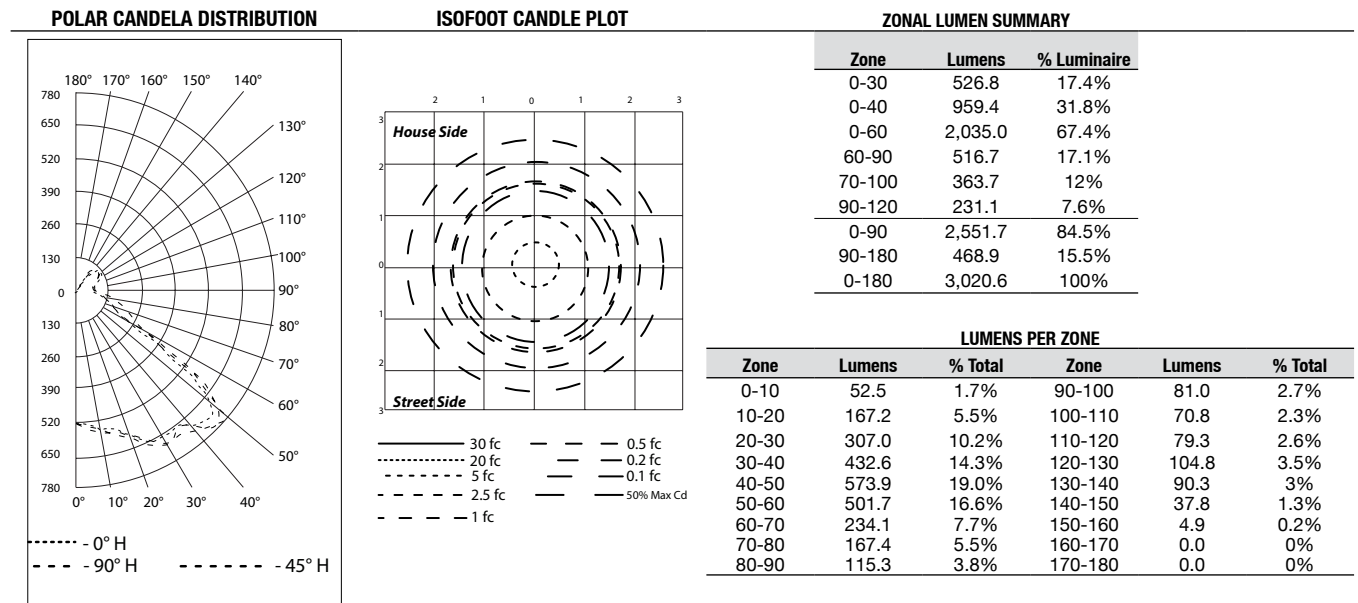

① AEx rating is only applicable to product configurations with terminal block wiring option.

APPLETON™
 LED/AREA: NEC/CEC, ATEX/IECEx ENCLOSED AND GASKETED

Contender™ LED Luminaires

Enclosed and Gasketed Fixtures

NEC/CEC:
 Class I, Division 2, Groups A,B,C,D
 Class I, Zone 2, AEx ec IIC ①
 Class II, Division 1, Groups E,F,G
 Zone 21, AEx tb IIIC ①

NEC/CEC:
 Class II, Division 2, Groups F,G
 Class III
 Type 3R, 4, 4X
 IP66/67

NEC/CEC:
 Simultaneous Exposure
 Suitable for Use in Wet Locations
 Marine Outside Type (Salt Water)
 American Bureau of Shipping (ABS) Certified

Photometric Data — DATA SHOWN IS ABSOLUTE

Type V, Clear Polycarbonate 5000K CCT
 REPORT NUMBER: VMV4LCP5BU

Luminaire Lumens 4,234

POLAR CANDELA DISTRIBUTION

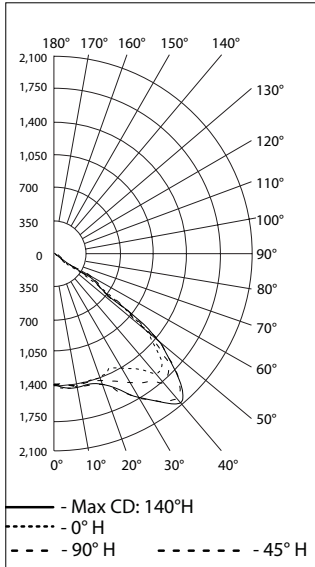

ISOFOOT CANDLE PLOT

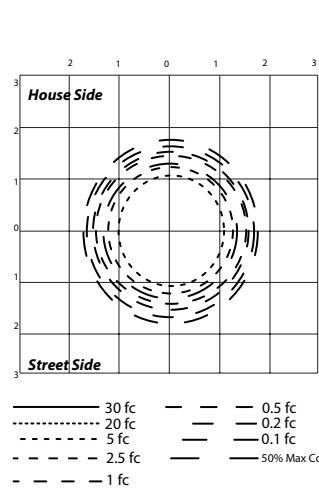

ZONAL LUMEN SUMMARY

Zone	Lumens	% Luminaire
0-30	1,229.4	29%
0-40	2,320.7	54.8%
0-60	4,178.7	98.7%
60-90	49.5	1.2%
70-100	18.7	0.4%
90-120	5.2	0.1%
0-90	4,228.2	99.9%
90-180	6.0	0.1%
0-180	4,234.3	100%

LUMENS PER ZONE

Zone	Lumens	% Total	Zone	Lumens	% Total
0-10	134.1	3.2%	90-100	2.3	0.1%
10-20	396.8	9.4%	100-110	1.9	0%
20-30	698.5	16.5%	110-120	1.0	0%
30-40	1,091.3	25.8%	120-130	0.8	0%
40-50	1,302.8	30.8%	130-140	0.0	0%
50-60	555.3	13.1%	140-150	0.0	0%
60-70	33.0	0.8%	150-160	0.0	0%
70-80	10.5	0.2%	160-170	0.0	0%
80-90	5.9	0.1%	170-180	0.0	0%

Type V, Clear Polycarbonate 5000K CCT
 REPORT NUMBER: VMV4LCD5BU

Luminaire Lumens 4,151

POLAR CANDELA DISTRIBUTION

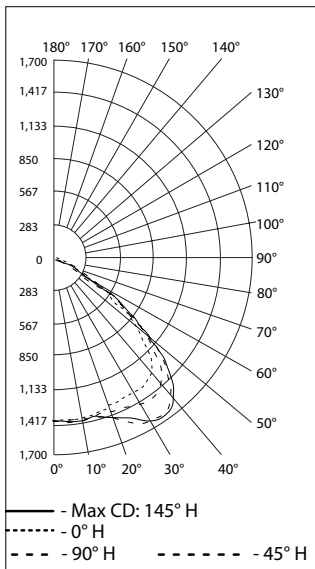

ISOFOOT CANDLE PLOT

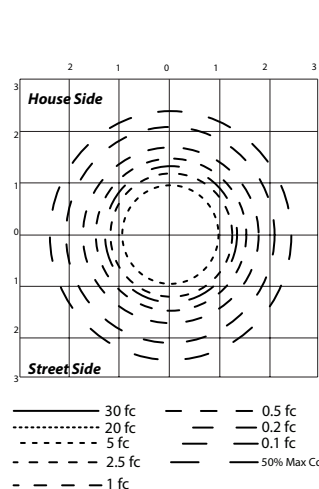

ZONAL LUMEN SUMMARY

Zone	Lumens	% Luminaire
0-30	1,206.1	29.1%
0-40	2,153.6	51.9%
0-60	3,742.1	90.2%
60-90	375.5	9%
70-100	142.2	3.4%
90-120	31.3	0.8%
0-90	4,117.6	99.2%
90-180	33.1	0.8%
0-180	4,150.7	100%

LUMENS PER ZONE

Zone	Lumens	% Total	Zone	Lumens	% Total
0-10	133.5	3.2%	90-100	11.7	0.3%
10-20	397.0	9.6%	100-110	14.0	0.3%
20-30	675.6	16.3%	110-120	5.5	0.1%
30-40	947.5	22.8%	120-130	1.6	0%
40-50	986.1	23.8%	130-140	0.1	0%
50-60	602.4	14.5%	140-150	0.1	0%
60-70	245.0	5.9%	150-160	0.0	0%
70-80	99.5	2.4%	160-170	0.0	0%
80-90	30.9	0.7%	170-180	0.0	0%

① AEx rating is only applicable to product configurations with terminal block wiring option.

Contender™ LED Luminaires

Enclosed and Gasketed Fixtures

NEC/CEC:

Class I, Division 2, Groups A,B,C,D
 Class I, Zone 2, AEx ec IIC ①
 Class II, Division 1, Groups E,F,G
 Zone 21, AEx tb IIIC ①

NEC/CEC:

Class II, Division 2, Groups F,G
 Class III
 Type 3R, 4, 4X
 IP66/67

NEC/CEC:

Simultaneous Exposure
 Suitable for Use in Wet Locations
 Marine Outside Type (Salt Water)
 American Bureau of Shipping (ABS) Certified

Photometric Data – DATA SHOWN IS ABSOLUTE

Type V, Clear Polycarbonate 5000K CCT

REPORT NUMBER: VMV4LCG5BU

Luminaire Lumens 4,468

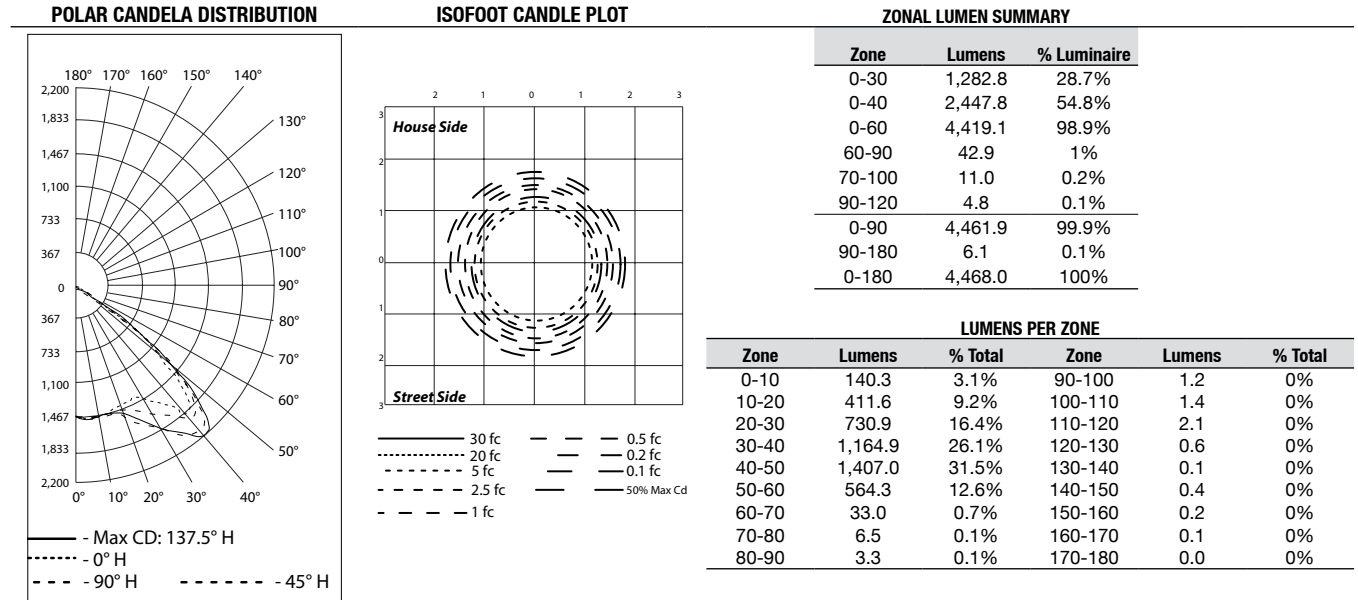

Type V, Clear Polycarbonate 5000K CCT

REPORT NUMBER: VMV4LCJ5BU

Luminaire Lumens 4,020

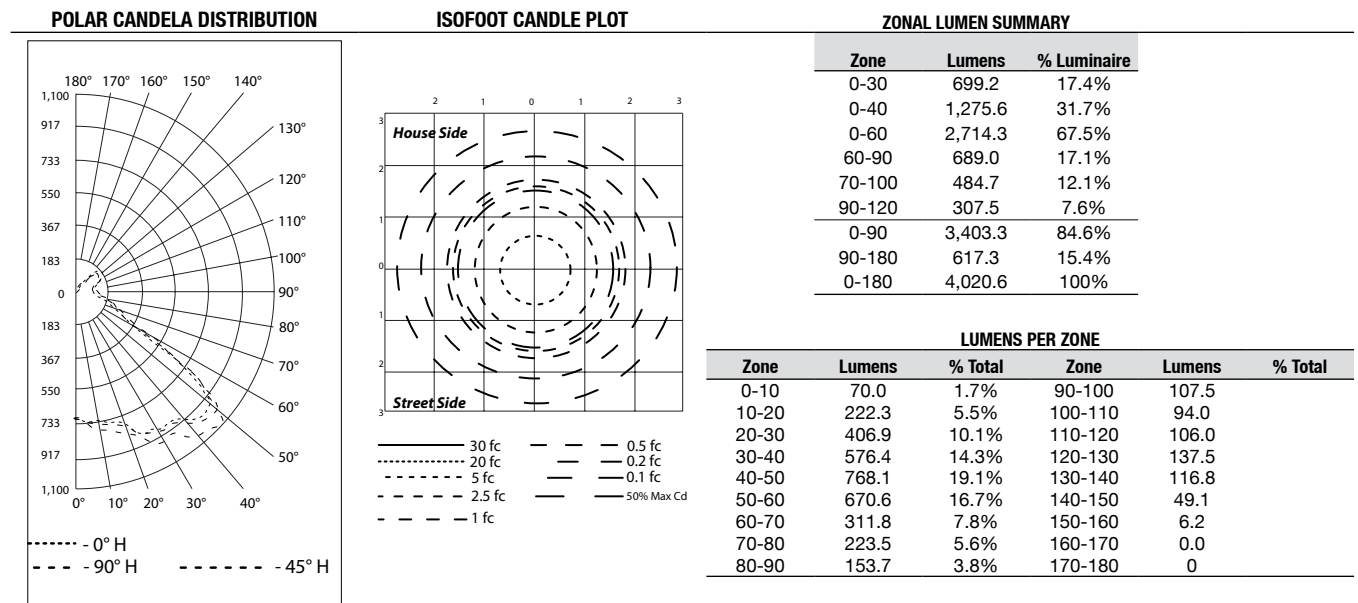

① AEx rating is only applicable to product configurations with terminal block wiring option.

Contender™ LED Luminaires

Enclosed and Gasketed Fixtures

NEC/CEC:

Class I, Division 2, Groups A,B,C,D
 Class I, Zone 2, AEx ec IIC ①
 Class II, Division 1, Groups E,F,G
 Zone 21, AEx tb IIIC ①

NEC/CEC:

Class II, Division 2, Groups F,G
 Class III
 Type 3R, 4, 4X
 IP66/67

NEC/CEC:

Simultaneous Exposure
 Suitable for Use in Wet Locations
 Marine Outside Type (Salt Water)
 American Bureau of Shipping (ABS) Certified

Photometric Data – DATA SHOWN IS ABSOLUTE

Type V, Clear Polycarbonate 5000K CCT

REPORT NUMBER: VMV5LCP5BU

Luminaire Lumens 5,330

POLAR CANDELA DISTRIBUTION

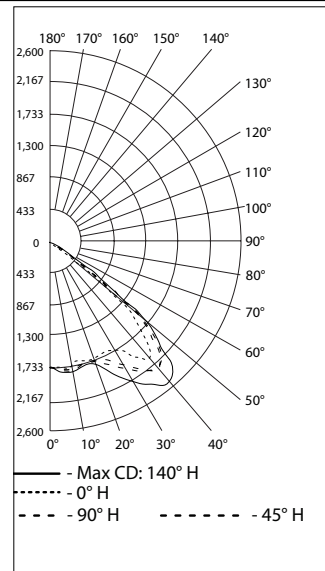

ISOFOOT CANDLE PLOT

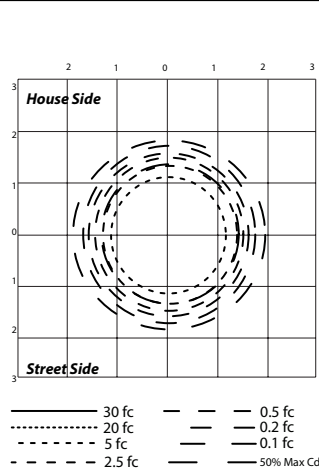

ZONAL LUMEN SUMMARY

Zone	Lumens	% Luminaire
0-30	1,525.8	28.6%
0-40	2,872.5	53.9%
0-60	5,237.4	98.3%
60-90	82.4	1.5%
70-100	29.4	0.6%
90-120	7.9	0.1%
0-90	5,319.8	99.8%
90-180	10.7	0.2%
0-180	5,330.5	100%

LUMENS PER ZONE

Zone	Lumens	% Total	Zone	Lumens	% Total
0-10	166.7	3.1%	90-100	3.1	0.1%
10-20	493.8	9.3%	100-110	3.0	0.1%
20-30	865.2	16.2%	110-120	1.7	0%
30-40	1,346.8	25.3%	120-130	0.9	0%
40-50	1,619.8	30.4%	130-140	0.6	0%
50-60	745.2	14.0%	140-150	0.6	0%
60-70	56.1	1.1%	150-160	0.4	0%
70-80	17.0	0.3%	160-170	0.2	0%
80-90	9.2	0.2%	170-180	0.1	0%

Type V, Clear Polycarbonate 5000K CCT

REPORT NUMBER: VMV5LCD5BU

Luminaire Lumens 5,150

POLAR CANDELA DISTRIBUTION

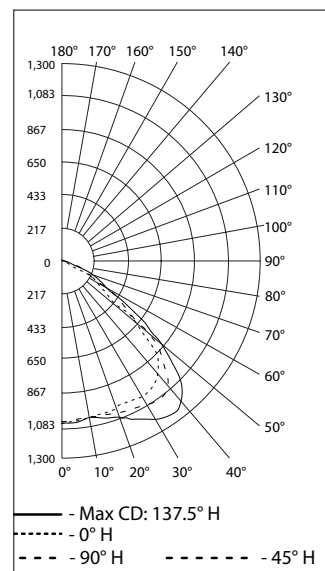

ISOFOOT CANDLE PLOT

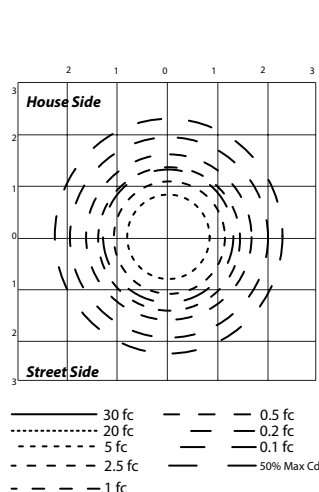

ZONAL LUMEN SUMMARY

Zone	Lumens	% Luminaire
0-30	1,484.5	28.8%
0-40	2,652.4	51.5%
0-60	4,632.4	89.9%
60-90	475.6	9.2%
70-100	180.0	3.5%
90-120	39.1	0.8%
0-90	5,108.0	99.2%
90-180	42.1	0.8%
0-180	5,150.1	100%

LUMENS PER ZONE

Zone	Lumens	% Total	Zone	Lumens	% Total
0-10	164.4	3.2%	90-100	14.5	0.3%
10-20	488.7	9.5%	100-110	17.8	0.3%
20-30	831.4	16.1%	110-120	6.9	0.1%
30-40	1,167.9	22.7%	120-130	2.0	0%
40-50	1,223.7	23.8%	130-140	0.3	0%
50-60	756.3	14.7%	140-150	0.2	0%
60-70	310.0	6.0%	150-160	0.2	0%
70-80	125.8	2.4%	160-170	0.1	0%
80-90	39.8	0.8%	170-180	0.1	0%

① AEx rating is only applicable to product configurations with terminal block wiring option.

Contender™ LED Luminaires

Enclosed and Gasketed Fixtures

NEC/CEC:

Class I, Division 2, Groups A,B,C,D
 Class I, Zone 2, AEx ec IIC ①
 Class II, Division 1, Groups E,F,G
 Zone 21, AEx tb IIIC ①

NEC/CEC:

Class II, Division 2, Groups F,G
 Class III
 Type 3R, 4, 4X
 IP66/67

NEC/CEC:

Simultaneous Exposure
 Suitable for Use in Wet Locations
 Marine Outside Type (Salt Water)
 American Bureau of Shipping (ABS) Certified

Photometric Data – DATA SHOWN IS ABSOLUTE

Type V, Clear Polycarbonate 5000K CCT

REPORT NUMBER: VMV5LCG5BU

Luminaire Lumens 5,529

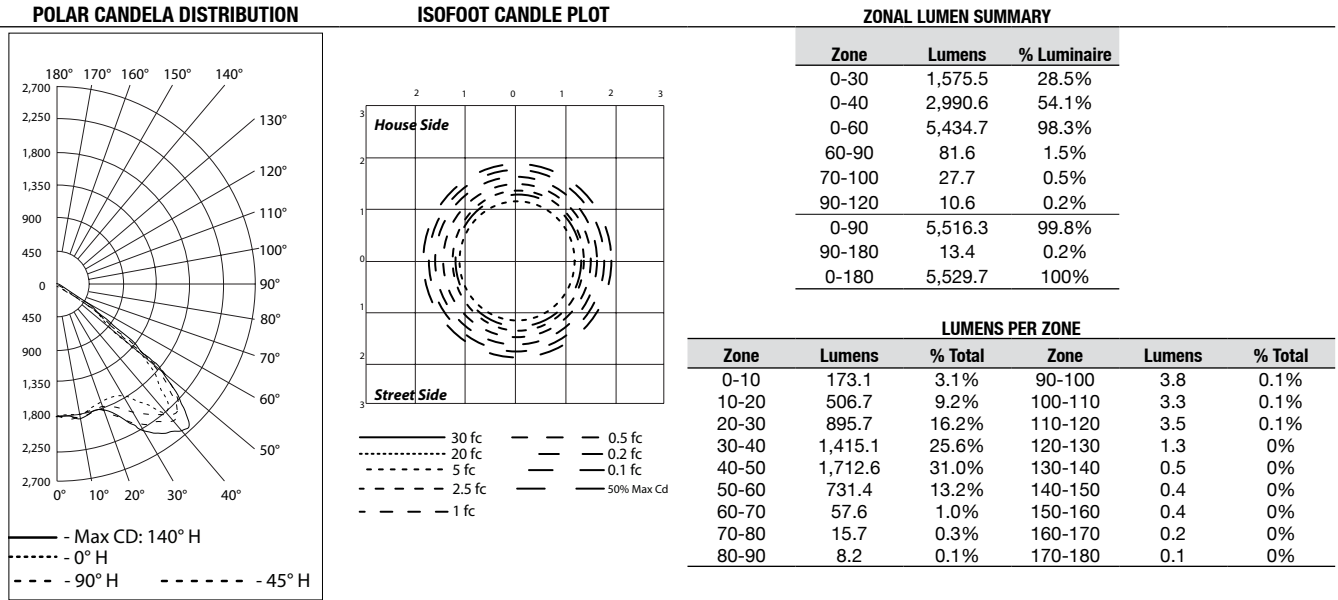

Type V, Clear Polycarbonate 5000K CCT

REPORT NUMBER: VMV5LCJ5BU

Luminaire Lumens 4,940

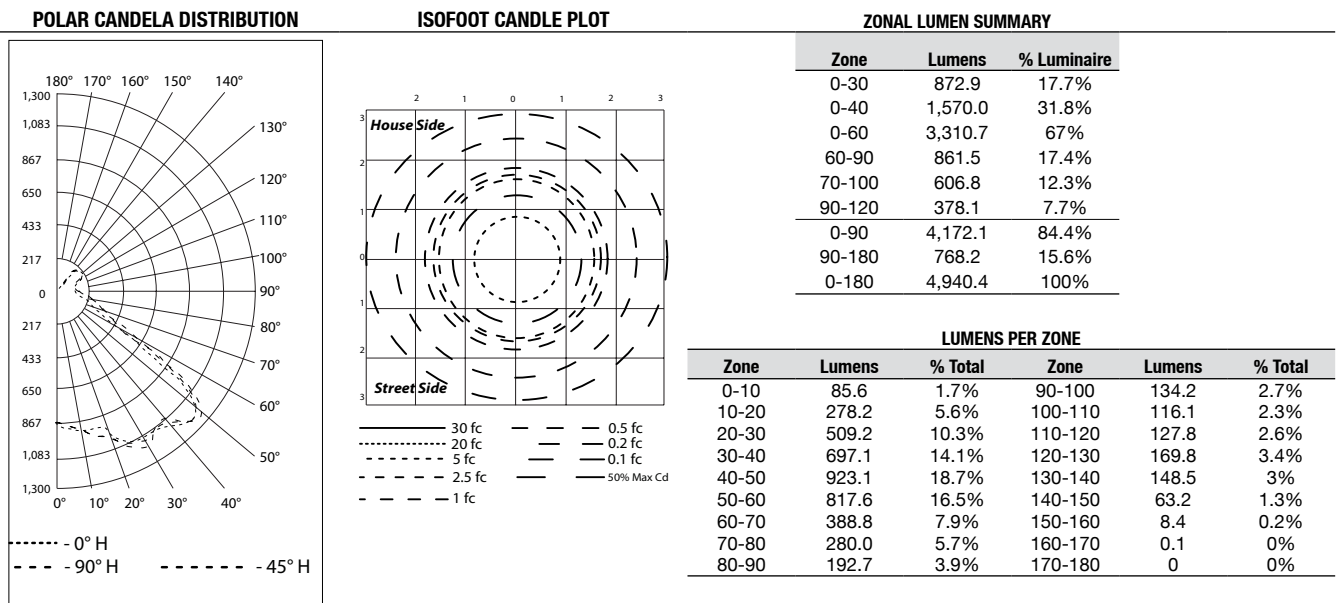

① AEx rating is only applicable to product configurations with terminal block wiring option.

APPLETON™
 LED/AREA: NEC/CEC, ATEX/IECEX ENCLOSED AND GASKETED