

PRODUCT GUIDE 9



MAKE THE POWER



STORE THE ENERGY



MANAGE THE SYSTEM



INTEGRATED SYSTEMS



INVERTER/CHARGERS



CHARGE CONTROLLERS



ENERGY STORAGE



COMMUNICATIONS



OutBack Power Technologies

Member of The Alpha Group

Masters of the Off-Grid™...

OutBack Power Technologies is the leading designer and manufacturer of advanced power conversion components and systems for renewable energy, backup, and mobile applications. From Baja to Bangladesh, from the Equator to the poles, OutBack components transform energy from renewable and conventional sources into the clean, reliable power that people need to transform the quality of their lives.

First Choice for the New Grid...

Identified by Pike Research as “far and away the leading vendor in the remote microgrid market,” OutBack’s leadership across all segments is rooted in the brand’s reputation for extreme reliability and dedication to technical innovation. The products here continue that tradition of excellence while bringing OutBack’s legendary off-grid technology and performance to an even wider range of energy production and power management applications.

A privately held company headquartered in Arlington, WA, OutBack Power is also a member of The Alpha Group—a global alliance of independent companies that share a common philosophy: create world-class powering solutions for communication, commercial, industrial and renewable energy markets. OutBack has pioneered many of the technologies that have become industry standards for power conversion technology, and there’s more to come.





Table of Contents

Integrated Systems

Benefits of Integrated Systems	6-7
Single-Brand Simplicity.....	8
FLEXpower Systems.....	9-13

Make the Power

Inverter/Chargers

FXR/VFXR Series.....	16-19
Radian Series	20-23
GTFX/GVFX Series.....	24-27
Specialized Application Models	28-33

Charge Controllers

FLEXmax Series	34-35
FLEXmax Extreme.....	36-37

Store the Energy

Energy Storage Introduction.....	40-41
Energy Storage Matrix.....	42
EnergyCell Batteries	43-48
Racks/Enclosures	49-52
FLEXcoupled Solution	53

Manage the System

OPTICS RE	56
MATE3, MATE and MATE2	58-59
AXS Port.....	60
HUB4 and HUB10.3.....	61
FLEXnet DC.....	62

Integration Products

FLEXware ICS.....	66
FLEXware ICS Plus	67
FLEXware PV Combiner Box Series.....	68
Mounting Plates.....	69
FLEXware 250.....	70-71
FLEXware 500.....	72-73
FLEXware 1000.....	74-75
Sample Bill of Materials.....	76-77
FLEXware Surge Protector	78
PSX-240.....	79

System Components, Accessories and Stacking Configurations

Panel Mount Breakers	82
DIN Breakers.....	82
PV Ground-Fault Detection and Interruption.....	83
DC Bus Bars.....	83
DC Current Shunts	83
Conduit Adapters.....	84
Mounting Brackets	84
DIN Rail End Clamp	84
DC Cable Assemblies	85
DC DIN Mount Breakers.....	85
High Voltage DIN Mount Fuse Holders and Fuses.....	86
Terminal Bus Bars.....	86
System Stacking Configurations.....	87

375-0028-3

- AC HOT OUT
- AC NEUTRAL OUT
- CHASSIS GROUND
- CHASSIS GROUND
- AC NEUTRAL IN
- AC HOT IN

INVERTER ON/OFF JP 1

INVERTER	ON/OFF	AUX +	AUX -	XCT -	XCT +
----------	--------	-------	-------	-------	-------

BATTERY TEMP

MATE / HUB

INVERTER AC IN Error

STATUS G Y R



375-0028-3

- AC HOT OUT
- AC NEUTRAL OUT
- CHASSIS GROUND
- CHASSIS GROUND
- AC NEUTRAL IN
- AC HOT IN

ON/OFF JP 1

INVERTER	ON/OFF	AUX +	AUX -	XCT -	XCT +
----------	--------	-------	-------	-------	-------





INTEGRATED SYSTEMS

Benefits of OutBack Integrated Systems	6-7
Single-Brand Simplicity	8
FLEXpower ONE.....	9
FLEXpower TWO.....	10
FLEXpower THREE.....	11
FLEXpower FOUR.....	12
FLEXpower Radian	13



FLEXPPOWER SYSTEMS

TAKE THE GUESSWORK OUT OF YOUR BEST WORK

Your time is valuable—with **FLEXpower integrated systems** you can spend less time on balance-of-system, and more time adding value to all of your installations. OutBack has based its FLEXpower platform on proven customer designs to **provide a factory-built, pre-configured, pre-wired and pre-tested alternative to designing individual projects from scratch.**



Integrated System Components

1 INVERTER/CHARGERS

OutBack Power offers the FXR/VFXR and Radian Series ideal for advanced Grid/Hybrid applications and full flexibility for grid-interactive and off-grid installations. All models have GridZero, Advanced Battery Charging and other intelligent features.

2 CHARGE CONTROLLERS

OutBack's industry-leading FLEXmax Series is the most recognized charge controller on the market. Innovative solar harvesting and battery charging algorithms allow customers to maximize system potential and increase renewable energy yield by up to 30%.

3 SYSTEM DISPLAY AND COMMUNICATIONS

OutBack's proprietary communication network enables all OutBack products to communicate with each other, providing a seamless setup and user experience across all components of an OutBack system.

4 OPTICS RE MONITORING & CONTROL

It's a powerful advantage...the ability to see the electricity you produce and consume. To monitor and control your renewable energy system with the touch of a button from any internet connected device—anywhere in the world. Real-time status and hands-on control of your power flow and energy storage. Track individual system performance or manage a network of dispersed systems.

5 ENERGY STORAGE

Every OutBack system is engineered to function as part of a battery-based renewable solution. OutBack Power's EnergyCell battery line represents the most complete family of renewable energy batteries available—from time-tested, deep cycle EnergyCell RE to the Partial State of Charge (PSoC) EnergyCell Nano-Carbon and 2V high capacity battery banks.

Integrated Systems

FLEXPPOWER ONE FXR

Ideal for smaller power applications including cabins, chalets, remote communication sites and backup power systems. OutBack's FLEXPpower ONE FXR accommodates all balance-of-system components in a cost-effective manner with the smallest possible footprint.

FLEXPPOWER TWO FXR

Ideal for applications with medium-sized power requirements such as larger homes and light commercial or backup power systems. With its compact design and easy-to-install mounting system, FLEXPpower TWO FXR can be mounted in a horizontal or vertical orientation to allow installation in more space-limited locations.

FLEXPPOWER THREE FXR

Designed for 120/208VAC 60Hz three-phase applications with medium-sized power requirements such as light commercial or larger backup power systems. The OutBack FLEXPpower THREE FXR is offered in 6kW, 9kW and 10.8kW configurations.

FLEXPPOWER FOUR FXR

Ideal for 120/240VAC split-phase applications with larger sized power requirements such as large residential, commercial or village microgrid power systems. FLEXPpower FOUR FXR systems are offered in 9.2kW, 12kW and 14.4kW configurations and can be combined with other FLEXPpower systems for up to 36kVA.

FLEXPPOWER RADIAN

Systems are available with the Radian A-Series 4kW or 8kW inverter/charger. In addition to GridZero and Advanced Battery Charging technology, FLEXPpower Radian systems have higher power and the flexibility of dual AC inputs for both grid and generator connection.



"A doctor cannot be expected to perform life-saving surgeries at night without power. Now through the provision of reliable solar power, doctors can treat patients at any time, this would not have been possible without OutBack."
 —Bob Freling, Solar Electric Light Fund (SELF)



"When it comes to residential PV, customers want options. That is why we sell and install OutBack Power's line of fully-integrated systems and components."
 —Travis Semmes, Mobile Solar

Make the Power, Store the Energy, Manage the System.

All OutBack Power components are designed to work seamlessly with one and other, resulting in system efficiency, simplified installation and single-source ordering and technical support. Every OutBack product is engineered to serve one of three key functions in a renewable energy system—Make, Store and Manage.





Single-Brand Simplicity

Customize Your System with OutBack Power

Every OutBack Power inverter/charger, charge controller and FLEXpower system is engineered to function as part of a battery-based renewable energy system. And OutBack Power's EnergyCell battery line is the most complete family of renewable energy batteries available.

From the time-tested, deep-cycle EnergyCell RE to the Partial State of Charge (PSoC) optimized EnergyCell Nano-Carbon to the 2V high capacity battery banks, OutBack energy storage solutions have you covered. Add to that the advantages of single-brand ordering and technical support—there is no reason to spec anything other than EnergyCell batteries to round out your OutBack Power system. That's why we call it single-brand simplicity.

STEP 1

Choose Your Integrated System



FLEXPOWER RADIAN | FLEXPOWER ONE | FLEXPOWER TWO | FLEXPOWER THREE | FLEXPOWER FOUR

STEP 2

Choose Your EnergyCell Battery and Rack/Enclosure

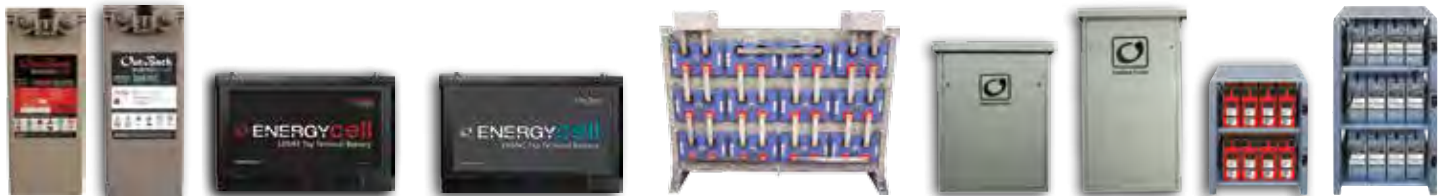

ENERGYCELL RE, GH, NC & OPZV | INDOOR & OUTDOOR ENCLOSURES | INTEGRATED BATTERY RACKS

SystemEdge

Choose one of OutBack's Pre-Engineered Solutions

Experience all the benefits of single-brand simplicity with a pre-bundled system from OutBack Power. We've identified some of the most popular FLEXpower plus energy storage configurations and combined them into a single SKU package to simplify ordering. Contact your OutBack Power sales representative to find out if a SystemEdge bundle is right for you. **Each solution features a FLEXpower Radian, EnergyCell batteries and a rack or enclosure, FLEXware ICS combiner box and OPTICS RE system monitoring and control.**



SystemEdge-420RE

SystemEdge-830NC



FLEXpower™ ONE FXR

Fully Pre-Wired Single Inverter System

OPTIMIZE WITH



OPTICS^{RE}



OutBack's pre-assembled and pre-wired FLEXpower ONE is now equipped with the updated FXR/VFXR Series inverter/chargers.

This means that the most advanced Grid/Hybrid inverter/charger features, including GridZero operation, are now available on the industry's most trusted and proven systems platform, for unmatched flexibility and value. The FLEXpower ONE FXR is available in six models for 120VAC or 230VAC applications ranging from 2,500W to 3,600W and are field selectable for 50Hz or 60Hz. Each system is field upgradable to eliminate downtime during critical updates, features seven programmable operating modes including GridZero and Advanced Battery Charging and offers remote monitoring and control through any internet enabled device with OPTICS RE.

The FLEXpower ONE is ideal for residential and commercial applications including cabins, vacation homes, farm buildings, remote communications sites and back-up power systems, with all necessary components integrated into a compact hang-on-the-wall system with a minimal footprint.

Product Highlights:

- Ideal for Modest Power Requirement Applications
- North American and International Voltages
- Handles up to 3,600 Watts

For 120VAC, 50/60Hz Applications	Description	Inverter(s)	FW-X240	Bypass	Outlet	Inverter OCPD**	PV OCPD**	RTS
FP1 FXR2524A	FXR2524A, 2.5kW FLEXpower ONE	FXR2524A	—	120VAC Bypass	NEMA 5-20R	250A	80A	Yes
FP1 VFXR3524A	VFXR3524A, 3.5kW FLEXpower ONE	VFXR3524A	—	120VAC Bypass	NEMA 5-20R	250A	80A	Yes
FP1 FXR3048A	FXR3048A, 3.0kW FLEXpower ONE	FXR3048A	—	120VAC Bypass	NEMA 5-20R	175A	80A	Yes
FP1 VFXR3648A	VFXR3648A, 3.6kW FLEXpower ONE	VFXR3648A	—	120VAC Bypass	NEMA 5-20R	175A	80A	Yes

For 230VAC, 50/60Hz Applications	Description	Inverter(s)	FW-X240	Bypass	Outlet	Inverter OCPD**	PV OCPD**	RTS
FP1 VFXR3048E	VFXR3048E, 3.0kW FLEXpower ONE	VFXR3048E	—	230VAC Bypass	—	250A	80A	Yes
FP1 VFXR3024E	VFXR3024E, 3.0kW FLEXpower ONE	VFXR3024E	—	230VAC Bypass	—	175A	80A	Yes

Details	FLEXpower ONE FXR
Finished Dimensions H x W x D (in/cm)	33.5 x 19.25 x 13.0 / 85 x 50 x 33
Weight (lb/kg)	98 / 44.5

*FLEXpower ONE FXR systems include a mounting bracket, FXR/VFXR inverter/charger, FLEXmax charge controller, MATE3, HUB10.3, FLEXnet DC, FLEXware surge protector, AC and DC wiring boxes, battery and PV array breakers, PV GFDI, Input-Output-Bypass assembly, mounting locations for GFCI outlets and additional AC breakers. Additional configurations available. ** Overcurrent protective device.



FLEXpower™ TWO FXR

Fully Pre-Wired Dual Inverter System

OPTIMIZE WITH



OPTICS_{RE}



OutBack's pre-assembled and pre-wired FLEXpower TWO is now equipped with the updated FXR/VFXR Series inverter/chargers.

This means that the most advanced Grid/Hybrid inverter/charger features are now available on the industry's most trusted and proven systems platform, for unmatched flexibility and value. The FLEXpower TWO FXR is available in seven models for 120VAC or 230VAC applications ranging from 5,000W to 7,200W and are field selectable for 50Hz or 60Hz. Each system is field upgradable to eliminate downtime during critical updates, features seven programmable operating modes including GridZero and Advanced Battery Charging and offers remote monitoring and control through any internet enabled device with OPTICS RE.

The FLEXpower TWO is an ideal full-sized solution for residential and commercial applications including homes, farms, small businesses, and back-up power systems, with all necessary components integrated into a compact hang-on-the-wall system with a minimal footprint.

Product Highlights:

- Ideal Solution for Residential and Commercial Applications
- GridZero Technology and Advanced Battery Charging
- Models from 5,000 to 7,000 Watts

For 120/240VAC, 50/60Hz Applications	Description	Inverter(s)	FW-X240	Bypass	Outlet	Inverter OCPD**	PV OCPD**	RTS
FP2 VFXR3524A	Dual VFXR3524A, 7.0kW FLEXpower TWO	VFXR3524A (x2)	—	240VAC Bypass	—	250A	80A	Yes
FP2 VFXR3648A	Dual VFXR3648A, 7.2kW FLEXpower TWO	VFXR3648A (x2)	—	240VAC Bypass	—	175A	80A	Yes
FP2 FXR3048A	Dual FXR3048A, 6.0kW FLEXpower TWO	FXR3048A (x2)	—	240VAC Bypass	—	175A	80A	Yes
FP2 FXR2524A	Dual FXR2524A, 5.0kW FLEXpower TWO	FXR2524A (x2)	—	240VAC Bypass	—	175A	80A	Yes

For 230VAC, 60/50Hz Applications	Description	Inverter(s)	FW-X240	Bypass	Outlet	Inverter OCPD**	PV OCPD**	RTS
FP2 VFXR3024E	Dual VFXR3024E, 6.0kW FLEXpower TWO	VFXR3024E (x2)	—	230VAC Bypass	—	175A	80A	Yes
FP2 VFXR3048E	Dual VFXR3048E, 6.0kW FLEXpower TWO	VFXR3048E (x2)	—	230VAC Bypass	—	250A	80A	Yes

Details	FLEXpower TWO FXR
Finished Dimensions H x W x D (in/cm)	20.25 x 46.5 x 13.0 / 51 x 118 x 33
Weight (lb/kg)	256 / 116



FLEXpower™ THREE FXR

Fully Pre-Wired Triple Inverter System

OPTIMIZE WITH



OPTICS^{RE}



OutBack's pre-assembled and pre-wired FLEXpower THREE is now equipped with the updated FXR/VFXR Series inverter/chargers.

This means that the most advanced Grid/Hybrid inverter/charger features are now available on the industry's most trusted and proven systems platform, for unmatched flexibility and value. The FLEXpower THREE FXR is available in two models for 120/208VAC applications ranging from 9kW to 10.8kW and three models for 230VAC applications in 6.0kW and 9.0kW. Each system field selectable for 50Hz or 60Hz, is field upgradable to eliminate downtime during critical updates, features seven programmable operating modes including GridZero and Advanced Battery Charging and offers remote monitoring and control through any internet enabled device with OPTICS RE.

The FLEXpower THREE is ideal for three-phase power needs such as larger residential, farms and agricultural installations, light commercial applications including small businesses, stores and restaurants, and remote facilities, with all necessary components integrated into a compact hang-on-the-wall system with a minimal footprint.

Product Highlights:

- For Off-Grid Commercial, Backup and Three-Phase Applications
- 6.0kW, 9kW and 10.8kW Standard Configurations
- Available with New FXR/VFXR Inverter/Chargers

For 120/208VAC, 50/60Hz Applications	Description	Inverter(s)	FW-X240	Bypass	Charge Controller	Inverter OCPD**	PV OCPD**	RTS
FP3 FXR3048A	Triple FXR3048A 9.0kW FLEXpower THREE	FXR3048A (3x)	—	208VAC Bypass	FLEXmax 80 (3x)	175A	80A	Yes
FP3 VFXR3648A	Triple VFXR3648A, 10.3kW FLEXpower THREE	VFXR3648A (3x)	—	208VAC Bypass	FLEXmax 80 (3x)	175A	80A	Yes

For 230VAC, 60/50Hz Applications	Description	Inverter(s)	FW-X240	Bypass	Charge Controller	Inverter OCPD**	PV OCPD**	RTS
FP3 VFXR3048E	Triple VFXR3048E 9.0kW FLEXpower THREE	VFXR3048E (3x)	—	240VAC Bypass	FLEXmax 80 (3x)	175A	80A	Yes
FP3 VFXR3024E	Triple VFXR3024E 9.0kW FLEXpower THREE	VFXR3024E (3x)	—	240VAC Bypass	FLEXmax 80 (3x)	250A	80A	Yes
FP3 FXR2024E	Triple FXR2024E 6.0kW FLEXpower THREE	FXR2024E (3x)	—	240VAC Bypass	FLEXmax 80 (3x)	175A	80A	Yes

Details		FLEXpower THREE FXR
Finished Dimensions H x W x D (in/cm)	46.0 x 58.425 x 13.0 / 116.84 x 148.40 x 33.02	
Weight (lb/kg)	433 / 196	

*FLEXpower THREE FXR systems include a mounting bracket, three FXR/VFXR inverter/chargers, three FLEXmax charge controllers, MATE3, HUB10.3, FLEXnet DC, FLEXware surge protector, AC and DC wiring boxes, battery and PV array breakers, PV GFDI, Input-Output-Bypass assembly, mounting locations for GFCI outlets and additional AC breakers.
 ** Overcurrent protective device.



FLEXpower™ FOUR FXR

Fully Pre-Wired Quad Inverter System

OPTIMIZE WITH



OPTICS^{RE}



OutBack's pre-assembled and pre-wired FLEXpower FOUR is now equipped with the updated FXR/VFXR Series inverter/chargers.

This means that the most advanced Grid/Hybrid inverter/charger features are now available on the industry's most trusted and proven systems platform, for unmatched flexibility and value. The FLEXpower FOUR FXR is available in two models for 120/240VAC applications ranging from 12kW to 14.4kW and two models for 230VAC applications in 9.2kW and 12kW. Each system field selectable for 50Hz or 60Hz, field upgradable to eliminate downtime during critical updates, features seven programmable operating modes including GridZero and Advanced Battery Charging and offers remote monitoring and control through any internet enabled device with OPTICS RE.

The FLEXpower FOUR is ideal for split-phase applications with large power requirements such as larger residential, commercial or village power systems, with all necessary components integrated into a compact hang-on-the-wall system with a minimal footprint.

Product Highlights:

- Ideal for Split-Phase Applications with Large Power Requirements
- 9.2kW, 12kW and 14.4kW Models Available
- GridZero Technology and Advanced Battery Charging

For 120/240VAC 60Hz Applications		Description	Inverter(s)	FW-X240	Bypass	Charge Controller	Inverter OCPD**	PV OCPD**	RTS
FP4 FXR3048A		Quad FXR3048A, 12.0kW FLEXpower FOUR	FXR3048A (x4)	Yes	240VAC Bypass	FLEXmax 80 (4x)	175A	80A	Yes
FP4 VFXR3648A		Quad VFXR3648A, 14.4kW FLEXpower FOUR	VFXR3648A (x4)	Yes	240VAC Bypass	FLEXmax 80 (4x)	175A	80A	Yes

For 230VAC, 60/50Hz Applications		Description	Inverter(s)	FW-X240	Bypass	Charge Controller	Inverter OCPD**	PV OCPD**	RTS
FP4 VFXR3048E		Quad VFXR3048E, 12.0kW FLEXpower FOUR	VFXR3048E (x2)	—	240VAC Bypass	FLEXmax 80 (4x)	175A	80A	Yes
FP4 FXR2348E		Quad FXR2348E, 9.2kW FLEXpower FOUR	FXR2348E (x2)	—	240VAC Bypass	FLEXmax 80 (4x)	175A	80A	Yes

Details		FLEXpower FOUR FXR
Finished Dimensions H x W x D (in/cm)	46.0 x 58.425 x 13.0 / 116.84 x 148.40 x 33.02	
Weight (lb/kg)	500 / 226	

*FLEXpower FOUR FXR systems include a mounting bracket, four FXR/VFXR inverter/chargers, four FLEXmax charge controllers, MATE3, HUB10.3, FLEXnet DC, FLEXware surge protector, AC and DC wiring boxes, battery and PV array breakers, PV GFDI, Input-Output-Bypass assembly, mounting locations for GFCI outlets and additional AC breakers. Additional configurations available. ** Overcurrent protective device.



FLEXpower™ Radian

Fully Pre-Wired 4kW or 8kW Inverter System

OPTIMIZE WITH



OPTICS^{RE}



FPR-8048A



FPR-4048A

OutBack's pre-assembled and pre-wired power systems take the concept of fast, easy installation to a new level of performance, value and flexibility with the FLEXpower Radian.

Everything needed, outside of power sources and battery backup, is completely integrated—just install the mounting bracket, hang the system on a wall, make the necessary connections and the system is fully operational.

Available with the Radian GS8048A or GS4048A (4kW or 8kW inverter/chargers), both models incorporate OutBack's GridZero technology, a superior level of intelligence in energy management for self-generation and self-consumption programs. It provides precise balancing between using stored energy, solar and utility power, blending-in the latter to overcome surges and load spikes. Both models feature an Advanced Battery Charging (ABC) profile option to support leading-edge battery technologies such as Lithium-Ion and others, and enhanced diagnostics for improved performance.

Product Highlights:

- Factory Tested, Pre-Wired and Pre-Configured System
- Fast Installation with Pre-Assembled System and Fully Integrated GS Load Center
- GridZero Technology Minimizes Grid Dependence
- All Components Carry Necessary ETL Certifications

Model*	Description	Inverter	GSLC	Bypass	Inverter OCPD**	PV OCPD**	GFDI	RTS	Charge Controller
FPR-4048A	GS4048A FLEXpower Radian	GS4048A	GSLC175-PV1-120/240	120/240VAC	175A	80A	Yes	Yes	(1) FLEXmax 80
FPR-8048A	GS8048A FLEXpower Radian	GS8048A	GSLC175-PV1-120/240	120/240VAC	175A	80A	Yes	Yes	(2) FLEXmax 80

Details	FLEXpower Radian 4048A	FLEXpower Radian 8048A
Finished Dimensions H x W x D (in/cm)	47.0 x 33.5 x 9.84 / 119.4 x 85.1 x 24.9	47.0 x 33.5 x 9.84 / 119.4 x 85.1 x 24.9
Weight (lb/kg)	195 / 88.5	250 / 113.4

*All pre-wired systems include a Radian Series inverter/charger, FLEXmax 80 charge controller(s), MATE3 system display and communications, FLEXnet DC system monitor, AC and DC wiring boxes, HUB10.3 communications, surge protector and remote temperature sensor (RTS). The FLEXpower Radian is also equipped with battery and PV array breakers, GFDI and input-output-bypass. See individual product specsheets or product guide for full specifications. **Overcurrent protective device.





MAKE THE POWER

Inverter/Chargers

FXR/VFXR Series Introduction	16-17
FXR 60Hz/120V (A-Series)	18
FXR 50Hz/230V (E-Series)	19
Radian Series Introduction	20-21
Radian Series Specifications	22
Radian GS Load Center	23
GTFX/GVFX Series Introduction	24
GTFX/GVFX 60Hz/120V	25
GTFX/GVFX 60Hz/127V	26
GTFX/GVFX 50Hz/230V	27
Specialized Application Models	
M-Series 60Hz/120V	28
M-Series 50Hz/230V	29
OBX Extreme Series 60Hz/120V	30
OBX Extreme Series 50Hz/230V	31
GFX International Series 60Hz/120V	32
GFX International Series 50Hz/230V	33

Charge Controllers

FLEXmax Series	34-35
FLEXmax Extreme	36-37



FXR/VFXR SERIES INVERTER/CHARGER

SAME LEGENDARY LOOK... **NEW ONBOARD TECHNOLOGY**

With the introduction of the **FXR/VFXR inverter/charger**, OutBack makes it easy to select a model that will meet your renewable energy needs today and into the future. **Combining the capabilities of an off-grid and grid-interactive inverter/charger into a single unit.**

FXR/VFXR Series Models

FXR/VFXR A-Series (For Selected North, Central and Latin American Countries)

	Model	System Power	Typical Efficiency
Sealed	FXR2012A	2.0kW, 120V	90%
	FXR2524A	2.5kW, 120V	92%
	FXR3048A	3.0kW, 120V	93%
Vented	VFXR2812A	2.8kW, 120V	90%
	VFXR3524A	3.5kW, 120V	92%
	VFXR3648A	3.6kW, 120V	93%

FXR/VFXR E-Series (For Europe, Asia and other Global Countries)

	Model	System Power	Typical Efficiency
Sealed	FXR2012E	2.0kW, 230V	90%
	FXR2024E	2.0kW, 230V	92%
	FXR2348E	2.3kW, 230V	93%
Vented	VFXR2612E	2.6kW, 230V	90%
	VFXR3024E	3.0kW, 230V	92%
	VFXR3048E	3.0kW, 230V	93%

FXR/VFXR Series Operating Modes

- 1 MINI GRID OPERATING MODE**
Ideal for sites where sufficient renewable energy enables mostly off-grid operation.
- 2 GRID-TIED OPERATING MODE**
Ideal for systems in regions with Feed-in-Tariff (FiT), net-metering or other incentive programs. Control use features include grid use timers.
- 3 GRIDZERO OPERATING MODE**
Ideal in areas where incentives are subject to change and utility sell-back options may be limited. Control use features include grid use timers.
- 4 SUPPORT OPERATING MODE**
Ideal for sites with small generators or inadequate grid power. Control use features include system-level high battery transfer (HBX) programming, prioritizing batteries as primary source.



- 5 BACKUP OPERATING MODE**
Ideal for systems where computers and other sensitive loads are present. Control use features include system-level high battery transfer (HBX) programming, prioritizing batteries as primary source.
- 6 UPS OPERATING MODE**
Ideal for commercial applications where uninterrupted power is mission-critical.
- 7 GENERATOR OPERATING MODE**
Ideal for systems with undersized or low power quality generators.

FXR/VFXR Series Technology

NEW ADVANCEMENTS

GridZero Technology

GridZero is a revolutionary operating mode, engineered by OutBack, that enables the PV system to use stored energy as the primary power source, blending in grid power only when needed.

Advanced Battery Charging

Incorporated in the new inverter/charger technology is a smarter way of battery charging for multiple types of energy storage technologies.

Grid/Hybrid Design

Capable of off-grid and grid-tied operation and with seven programmable modes, in a single model, the FXR/VFXR is truly a “one size fits all” solution for power conversion.

OPTICS RE Monitoring and Control

OutBack inverter/chargers often operate the most remote locations on the planet, OPTICS RE, OutBack’s web-enabled monitoring and control platform, provides real-time status updates and hands-on control at the touch of a button.

TIME-TESTED DESIGN

Pure Sinewave Technology

OutBack FXR/VFXR inverter/chargers use proprietary technology to deliver an AC sinewave that’s cleaner than some utilities can produce.

Cast-Aluminum Chassis

Cast-aluminum does not bend or deform, so it is ideal for protecting internal components from harsh environmental conditions.

Advanced Internal Heat Management

OutBack inverter/chargers use innovative forced-convection architecture to maintain an optimal operating temperature range.

Flexibility and Expandability

The OutBack FXR/VFXR can support sub-phase master stacking for three-phase and other larger grid-tied applications.



“Despite being only a few miles from the nearest power plant, we experienced outages several times a year. Once we installed the OutBack Power system, we found we were much closer to independence from the grid.”

—Tom Hurd, Spatial Designs



“The OutBack Power system allows us to uphold our commitment to providing clean, reliable power domestically and internationally in a system that is self-contained.”

—Joey Romano, Adaptive Container LLC

Make the Power, Store the Energy, Manage the System.

OutBack Power has built its reputation by developing the industry’s most robust, reliable and innovative inverter/chargers. **Built around ground breaking, forward-thinking design, OutBack’s FXR/VFXR Series inverter/chargers are the recognized standard** in off-grid and grid-connected applications.





FXR/VFXR

50/60Hz (Selectable) 120V A-Series Grid/Hybrid Inverter/Chargers

OPTIMIZE WITH



OPTICS^{RE}

Models:	Sealed			Vented		
	FXR2012A	FXR2524A	FXR3048A	VFXR2812A	VFXR3524A	VFXR3648A
Continuous Power Rating (@ 25° C)	2000VA	2500VA	3000VA	2800VA	3500VA	3600VA
AC Output Voltage (selectable)	120VAC (100-130VAC)	120VAC (100-130VAC)	120VAC (100-130VAC)	120VAC (100-130VAC)	120VAC (100-130VAC)	120VAC (100-130VAC)
AC Output Frequency (selectable)	60Hz (50Hz)	60Hz (50Hz)	60Hz (50Hz)	60Hz (50Hz)	60Hz (50Hz)	60Hz (50Hz)
Nominal DC Input Voltage	12VDC	24VDC	48VDC	12VDC	24VDC	48VDC
Continuous AC RMS Output (@ 25° C)	16.7AAC	20.8AAC	25AAC	23.3AAC	29.2AAC	30AAC
Idle Power	Full: ~34W Search: ~9W Off: ~3W	Full: ~34W Search: ~9W Off: ~3W	Full: ~34W Search: ~9W Off: ~3W	Full: ~34W Search: ~9W Off: ~3W	Full: ~34W Search: ~9W Off: ~3W	Full: ~34W Search: ~9W Off: ~3W
Typical Efficiency	90%	92%	93%	90%	92%	93%
CEC Weighted Efficiency	—	—	91%	—	90.5%	91%
Peak Efficiency	—	—	—	—	—	95%
Total Harmonic Distortion	Typical: < 2% Maximum: < 5%	Typical: < 2% Maximum: < 5%	Typical: < 2% Maximum: < 5%	Typical: < 2% Maximum: < 5%	Typical: < 2% Maximum: < 5%	Typical: < 2% Maximum: < 5%
Output Voltage Regulation	± 2.5%	± 2.5%	± 2.5%	± 2.5%	± 2.5%	± 2.5%
Maximum Output Current	Peak: 56AAC RMS: 40AAC	Peak: 70AAC RMS: 50AAC	Peak: 70AAC RMS: 50AAC	Peak: 56AAC RMS: 40AAC	Peak: 70AAC RMS: 50AAC	Peak: 70AAC RMS: 50AAC
AC Overload Capability	Surge: 4800VA 5 Sec: 4500VA 30 Min: 2500VA	Surge: 6000VA 5 Sec: 5400VA 30 Min: 3200VA	Surge: 6000VA 5 Sec: 5400VA 30 Min: 3200VA	Surge: 4800VA 5 Sec: 4500VA 30 Min: 3200VA	Surge: 6000VA 5 Sec: 5400VA 30 Min: 4000VA	Surge: 6000VA 5 Sec: 5400VA 30 Min: 4000VA
AC Input Voltage Range (MATE3 Adjustable)	85 to 140VAC	85 to 140VAC	85 to 140VAC	85 to 140VAC	85 to 140VAC	85 to 140VAC
AC Input Frequency Range	54 to 66Hz (45 to 55Hz)	54 to 66Hz (45 to 55Hz)	54 to 66Hz (45 to 55Hz)	54 to 66Hz (45 to 55Hz)	54 to 66Hz (45 to 55Hz)	54 to 66Hz (45 to 55Hz)
AC Input Tare Loss	0VA	0VA	0VA	0VA	0VA	0VA
Grid-Interactive Voltage Range	—	106 to 132VAC	106 to 132VAC	—	106 to 132VAC	106 to 132VAC
Grid-Interactive Frequency Range	—	59.3 to 60.5Hz	59.3 to 60.5Hz	—	59.3 to 60.5Hz	59.3 to 60.5Hz
AC Input Current Maximum	60AAC	60AAC	60AAC	60AAC	60AAC	60AAC
Continuous Battery Charge Output	100ADC	55ADC	35ADC	125ADC	82ADC	45ADC
Maximum Battery Charging (AC/DC/Power)	14AAC / 100ADC / 1360VA	14AAC / 55ADC / 1500VA	14AAC / 35ADC / 1900VA	18AAC / 125ADC / 1700VA	20AAC / 82ADC / 2230VA	20AAC / 45ADC / 2450VA
DC Input Voltage Range	10.5 to 17VDC	21 to 34VDC	42 to 68VDC	10.5 to 17VDC	21 to 34VDC	42 to 68VDC
Warranty	Standard 5-yr / optional 10-yr	Standard 5-yr / optional 10-yr	Standard 5-yr / optional 10-yr	Standard 5-yr / optional 10-yr	Standard 5-yr / optional 10-yr	Standard 5-yr / optional 10-yr
Weight (lb/kg)	Unit: 62 / 29 Shipping: 67 / 30	Unit: 62 / 29 Shipping: 67 / 30	Unit: 62 / 29 Shipping: 67 / 30	Unit: 61 / 28 Shipping: 67 / 30	Unit: 61 / 28 Shipping: 67 / 30	Unit: 61 / 28 Shipping: 67 / 30
Dimensions H x W x L (in/cm)	Unit: 13 x 8.25 x 16.25 / 33 x 21 x 41 Shipping: 21.75 x 13 x 22 / 55 x 33 x 56			Unit: 12 x 8.25 x 16.25 / 30 x 21 x 41 Shipping: 21.75 x 13 x 22 / 55 x 33 x 56		
Temperature Range	Rated: -20 to 50°C Operating: -40 to 60°C Storage: -40 to 60°C	Rated: -20 to 50°C Operating: -40 to 60°C Storage: -40 to 60°C	Rated: -20 to 50°C Operating: -40 to 60°C Storage: -40 to 60°C	Rated: -20 to 50°C Operating: -40 to 60°C Storage: -40 to 60°C	Rated: -20 to 50°C Operating: -40 to 60°C Storage: -40 to 60°C	Rated: -20 to 50°C Operating: -40 to 60°C Storage: -40 to 60°C
Relative Humidity Rating	93%	93%	93%	93%	93%	93%
Listings/Certifications	UL 1741, CSA C22.2 No. 107.1, UL 1778 Annex FF	UL 1741, CSA C22.2 No. 107.1, UL 1778 Annex F	UL 1741, CSA C22.2 No. 107.1, UL 1778 Annex FF	UL 1741, CSA C22.2 No. 107.1, UL 1778 Annex FF	UL 1741, CSA C22.2 No. 107.1, UL 1778 Annex FF	UL 1741, CSA C22.2 No. 107.1, UL 1778 Annex FF
RoHS Compliance	Yes	Yes	Yes	Yes	Yes	Yes



FXR/VFXR

50/60Hz (Selectable) 230V E-Series Grid/Hybrid Inverter/Chargers

OPTIMIZE WITH



OPTICS^{RE}

Models:	Sealed			Vented		
	FXR2012E	FXR2024E	FXR2348E	VFXR2612E	VFXR3024E	VFXR3048E
Continuous Power Rating (@ 25° C)	2000VA	2000VA	2300VA	2600VA	3000VA	3000VA
AC Output Voltage (Selectable)	230VAC (200-260VAC)	230VAC (200-260VAC)	230VAC (200-260VAC)	230VAC (200-260VAC)	230VAC (200-260VAC)	230VAC (200-260VAC)
AC Output Frequency (Selectable)	50Hz (60Hz)	50Hz (60Hz)	50Hz (60Hz)	50Hz (60Hz)	50Hz (60Hz)	50Hz (60Hz)
Nominal DC Input Voltage	12VDC	24VDC	48VDC	12VDC	24VDC	48VDC
Continuous AC RMS Output (@ 25° C)	8.7AAC	8.7AAC	10AAC	11.3AAC	13AAC	13AAC
Idle Power	Full: ~34W Search: ~9W Off: ~3W	Full: ~34W Search: ~9W Off: ~3W	Full: ~34W Search: ~9W Off: ~3W	Full: ~34W Search: ~9W Off: ~3W	Full: ~34W Search: ~9W Off: ~3W	Full: ~34W Search: ~9W Off: ~3W
Typical Efficiency	90%	92%	93%	90%	92%	93%
CEC Weighted Efficiency	—	—	—	—	—	—
Total Harmonic Distortion	Typical: < 2% Maximum: < 5%	Typical: < 2% Maximum: < 5%	Typical: < 2% Maximum: < 5%	Typical: < 2% Maximum: < 5%	Typical: < 2% Maximum: < 5%	Typical: < 2% Maximum: < 5%
Output Voltage Regulation	± 2.5%	± 2.5%	± 2.5%	± 2.5%	± 2.5%	± 2.5%
Maximum Output Current	Peak: 28AAC RMS: 20AAC	Peak: 35AAC RMS: 25AAC	Peak: 35AAC RMS: 25AAC	Peak: 28AAC RMS: 20AAC	Peak: 35AAC RMS: 25AAC	Peak: 35AAC RMS: 25AAC
AC Overload Capability	Surge: 4600VA 5 Sec: 4300VA 30 Min: 2500VA	Surge: 5750VA 5 Sec: 5175VA 30 Min: 3100VA	Surge: 5750VA 5 Sec: 5175VA 30 Min: 3100VA	Surge: 4600VA 5 Sec: 4300VA 30 Min: 3100VA	Surge: 5750VA 5 Sec: 5175VA 30 Min: 3300VA	Surge: 5750VA 5 Sec: 5175VA 30 Min: 3300VA
AC Input Voltage Range (MATE3 Adjustable)	170 to 290VAC	170 to 290VAC	170 to 290VAC	170 to 290VAC	170 to 290VAC	170 to 290VAC
AC Input Frequency Range	45 to 55Hz (54 to 66Hz)	45 to 55Hz (54 to 66Hz)	45 to 55Hz (54 to 66Hz)	45 to 55Hz (54 to 66Hz)	45 to 55Hz (54 to 66Hz)	45 to 55Hz (54 to 66Hz)
AC Input Tare Loss	0 VA	0 VA	0 VA	0 VA	0 VA	0 VA
Grid-Interactive Voltage Range	—	208 to 252VAC	208 to 252VAC	—	208 to 252VAC	208 to 252VAC
Grid-Interactive Frequency Range	—	47 to 51Hz	47 to 51Hz	—	47 to 51Hz	47 to 51Hz
AC Input Current Maximum	30AAC	30AAC	30AAC	30AAC	30AAC	30AAC
Continuous Battery Charge Output	100ADC	55ADC	35ADC	120ADC	80ADC	40ADC
Maximum Battery Charging (AC/DC/Power)	7AAC / 100ADC / 1360VA	7AAC / 55ADC / 1500VA	7AAC / 35ADC / 1900VA	9AAC / 120ADC / 1630VA	10AAC / 80ADC / 2180VA	10AAC / 40ADC / 2180VA
DC Input Voltage Range	10.5 to 17VDC	21 to 34VDC	42 to 68VDC	10.5 to 17VDC	21 to 34VDC	42 to 68VDC
Warranty	Standard 5-yr / optional 10-yr	Standard 5-yr / optional 10-yr	Standard 5-yr / optional 10-yr	Standard 5-yr / optional 10-yr	Standard 5-yr / optional 10-yr	Standard 5-yr / optional 10-yr
Weight (lb/kg)	Unit: 62 / 29 Shipping: 67 / 30	Unit: 62 / 29 Shipping: 67 / 30	Unit: 62 / 29 Shipping: 67 / 30	Unit: 61 / 28 Shipping: 67 / 30	Unit: 61 / 28 Shipping: 67 / 30	Unit: 61 / 28 Shipping: 67 / 30
Dimensions H x W x L (in/cm)	Unit: 13 x 8.25 x 16.25 / 33 x 21 x 41 Shipping: 21.75 x 13 x 22 / 55 x 33 x 56			Unit: 12 x 8.25 x 16.25 / 30 x 21 x 41 Shipping: 21.75 x 13 x 22 / 55 x 33 x 56		
Temperature Range	Rated: -20 to 50°C Operating: -40 to 60°C Storage: -40 to 60°C	Rated: -20 to 50°C Operating: -40 to 60°C Storage: -40 to 60°C	Rated: -20 to 50°C Operating: -40 to 60°C Storage: -40 to 60°C	Rated: -20 to 50°C Operating: -40 to 60°C Storage: -40 to 60°C	Rated: -20 to 50°C Operating: -40 to 60°C Storage: -40 to 60°C	Rated: -20 to 50°C Operating: -40 to 60°C Storage: -40 to 60°C
Relative Humidity Rating	93%	93%	93%	93%	93%	93%
Listings/Certifications	IEC 62109-1, CE	IEC 62109-1, CE	IEC 62109-1, CE	IEC 62109-1, CE	IEC 62109-1, CE	IEC 62109-1, CE
RoHS Compliance	Yes	Yes	Yes	Yes	Yes	Yes



RADIAN SERIES INVERTER/CHARGER

FUTURE-PERFECT SYSTEM DESIGN

With all the hallmark features you've come to expect from the **Radian inverter/charger**, the expanded Radian family includes **four models, seven operating modes** and **two advanced new technologies**, all adding up to unmatched performance, reliability, value and system flexibility.



Radian Series Inverter/Charger with GS Load Center

Radian Series Models

Model Name	System Power	Market
GS8048A	8kW, 120/240V	For Selected North, Central and Latin American Countries
GS4048A	4kW, 120/240V	
GS7048E	7kW, 230V	For Europe, Asia and other Global Countries
GS3548E	3.5kW, 230V	

Radian Series Operating Modes

- 1 MINI GRID** OPERATING MODE
Ideal for sites where sufficient renewable energy enables mostly off-grid operation.
- 2 GRID-TIED** OPERATING MODE
Ideal for systems in regions with Feed-in-Tariff (FIT), net-metering or other incentive programs. Control use features include grid use timers.
- 3 GRIDZERO** OPERATING MODE
Ideal in areas where incentives are subject to change and utility sell-back options may be limited. Control use features include grid use timers.
- 4 SUPPORT** OPERATING MODE
Ideal for sites with small generators or inadequate grid power. Control use features include system-level high battery transfer (HBX) programming, prioritizing batteries as primary source.
- 5 BACKUP** OPERATING MODE
Ideal for systems where computers and other sensitive loads are present. Control use features include system-level high battery transfer (HBX) programming, prioritizing batteries as primary source.
- 6 UPS** OPERATING MODE
Ideal for commercial applications where uninterrupted power is mission-critical.
- 7 GENERATOR** OPERATING MODE
Ideal for systems with undersized or low power quality generators.

Radian Series Technologies

GRIDZERO

The newest of the Grid/Hybrid Radian's seven input modes, GridZero provides **the perfect balance between utility power and stored renewable energy**. By allowing a home or business to satisfy most of its power needs with renewable sources, grid supplied power is only tapped when load demand exceeds a pre-set threshold. While the Radian is still grid-connected, grid dependence can be reduced to zero whenever possible. GridZero technology offers four critical advantages compared to typical systems:

Higher System Economics: By maximizing the contribution of renewables to total energy consumption, selling back to the grid is no longer required for system Return on Investment (ROI).

Lower Cost-of-Entry: Through seamless blending of grid power and renewable energy sources, a smaller system can perform like a much larger one, reducing equipment and installation costs.

Greater Simplicity: Because the Radian Series remains connected and synchronized to the grid, no destabilizing transfer is required when grid power is needed.

"Best Case Scenario" Design: As energy policies and incentives change, GridZero technology can prioritize self-consumption and offset over sell-back to always deliver the best renewable energy value possible.

ADVANCED BATTERY CHARGING

OutBack built its reputation on legendary off-grid reliability and battery backup expertise. That background is thoroughly built into the new Radians. In addition to GridZero Technology, the new Radians also feature an Advanced Battery Charging (ABC) profile option. Advanced Battery Charging offers **expanded charging voltage and time parameters, enabling system designers to accommodate the specific charging profiles** and algorithms of newer energy storage technologies including:

- **Lithium Ion** Batteries
- **Aqueous Ion** Batteries
- **Flow Chemistry** Batteries



"Ontario residents are faced with confusing energy policies and fluctuating grid electricity rates. GridZero is a great solution to our energy challenges."

—Brian Nash, Haliburton Solar and Wind



"We wanted to build a mobile renewable energy trailer that had a small footprint for our events. We were impressed with the OutBack Radian because it produces a high power output but is compact and modular."

—Peter Clark, Solamor Event Services

Make the Power, Store the Energy, Manage the System.



OutBack is an industry-leading, full system solutions provider for off-grid and grid-connected applications. The Radian Series inverter/charger is **engineered to provide best-in-class reliability to make energy from your renewable sources work**. The Radian Series, when paired with energy storage and system management products make OutBack an all-in-one solution.



Radian™ Series

Specifications

OPTIMIZE WITH



OPTICS_{RE}

Models:	Domestic (For Selected North, Central and Latin American Countries)		International (For Europe, Asia and Global Countries)	
	GS8048A	GS4048A	GS7048E	GS3548E
Nominal DC Input Voltage	48VDC	48VDC	48VDC	48VDC
Continuous Output Power (@ 25°C)	8000VA	4000VA	7000VA	3500VA
AC Output Voltage (Selectable)	120/240VAC (200-260VAC)	120/240VAC (200-260VAC)	230VAC (210-250VAC)	230VAC (210-250VAC)
AC Output Frequency (Selectable)	60Hz (50Hz)	60Hz (50Hz)	50Hz (60Hz)	50Hz (60Hz)
Continuous AC Output Current (@ 25°C)	33.3AAC @ 240VAC	16.7AAC	30AAC	15.2AAC
Idle Consumption (Invert Mode, No Load)	34W	34W	34W	34W
Typical Efficiency	93%	93%	92%	92%
CEC Weighted Efficiency	92.5%	92.5%	96% (peak efficiency)	96% (peak efficiency)
Total Harmonic Distortion	Max. Total Harmonic: <5%, Max. Single Voltage Harmonic: <2%		Max. Total Harmonic: <5%, Max. Single Voltage Harmonic: <2%	
Output Voltage Regulation	±2%	±2%	±2%	±2%
Maximum Output Current	1ms Peak: 100AAC @ 240VAC, 200AAC @ 120VAC 100ms RMS: 70.7AAC @ 240VAC	1ms Peak: 50AAC @ 240VAC 100ms RMS: 35.35AAC @ 240VAC	1ms Peak: 100AAC 100ms RMS: 70.7AAC	1ms Peak: 50AAC 100ms RMS: 35.35AAC
Overload Capacity	100ms Surge: 16.97kVA 5 Seconds: 12.0kVA 30 Minutes: 9.0kVA	100ms Surge: 8.5kVA 5 Seconds: 6.0kVA 30 Minutes: 4.5kVA	100ms Surge: 16.3kVA 5 Seconds: 11.5kVA 30 Minutes: 7.9kVA	100ms Surge: 8.2kVA 5 Seconds: 5.8kVA 30 Minutes: 4.0kVA
AC Input Voltage Range (Adjustable)	(L1-N or L2-N) 85 to 140VAC	(L1-N or L2-N) 85 to 140VAC	(L-N) 170 to 290VAC	(L-N) 170 to 290VAC
AC Input Frequency Range (Default)	54 to 66Hz @ 60Hz (45 to 55Hz @ 50Hz)		45 to 55Hz @ 50Hz (54 to 66Hz @ 60Hz)	
Grid-Interactive Voltage Range (Default)	(L1-N or L2-N) 108 to 132VAC	(L1-N or L2-N) 108 to 132VAC	(L-N) 208 to 252VAC	(L-N) 208 to 252VAC
Grid-Interactive Frequency Range	59.3 to 60.5Hz	59.3 to 60.5Hz	57.0 to 61.0Hz	57.0 to 61.0Hz
Maximum AC Input Current	50AAC @ 240VAC	50AAC @ 240VAC	50AAC	50AAC
Maximum Utility Interactive Current	30A	15A	30A	15A
Continuous Battery Charge Output	115.0ADC	57.5ADC	100.0ADC	50.0ADC
DC Input Voltage Range	40 to 64VDC	40 to 64VDC	40 to 64VDC	40 to 64VDC
Temperature Range (Power derated above 25°C)	Rated: -20 to 50°C Maximum: -40 to 60°C	Rated: -20 to 50°C Maximum: -40 to 60°C	Rated: -20 to 50°C Maximum: -40 to 60°C	Rated: -20 to 50°C Maximum: -40 to 60°C
Accessory Ports	Remote Temperature Sensor, MATE3 & HUB Communications		Remote Temperature Sensor, MATE3 & HUB Communications	
Non-Volatile Memory	Yes	Yes	Yes	Yes
Field Upgradable Firmware	Yes	Yes	Yes	Yes
Chassis Type	Vented	Vented	Vented	Vented
Certifications	ETL Listed to UL1741, CE, CSA C22.2 No.107.1, UL 1778 Annex F, IEC 62109-1 ETL, RoHS compliant per directive 2011/65/EU, FCC Class B, IEEE 1547.1, EN61000-6-1, EN61000-6-3, EN61000-3-2, EN61000-3-3	ETL Listed to UL1741, CE, CSA C22.2 No.107.1, UL 1778 Annex F, IEC 62109-1 ETL, RoHS compliant per directive 2011/65/EU, FCC Class B, IEEE 1547.1, EN61000-6-1, EN61000-6-3, EN61000-3-2, EN61000-3-3	IEC 62477-1, AS4777.2, AS477.3, EN61000-6-1, EN61000-6-3, EN61000-3-2, EN61000-3-3, AS3100, CE, RoHS compliant per directive 2011/65/EU	IEC 62109-1, IEC 62477-1, AS4777.2, AS477.3, EN61000-6-1, EN61000-6-3, EN61000-3-2, EN61000-3-3, AS3100, CE, RoHS compliant per directive 2011/65/EU
Warranty	Standard 5 year, available 10 year		Standard 5 year, available 10 year	
Weight (lb/kg)	Unit: 125.0 / 56.7 Shipping: 140.0 / 63.5	Unit: 82.0 / 37.2 Shipping: 94.0 / 42.6	Unit: 125.0 / 56.7 Shipping: 140.0 / 63.5	Unit: 81.0 / 36.7 Shipping: 93.0 / 42.1
Dimensions H x W x D (in/cm)	Unit: 28 x 16 x 8.7 / 71.1 x 40.6 x 22.1 Shipping: 34.5 x 21 x 14.5 / 87.6 x 53.3 x 36.8		Unit: 28 x 16 x 8.7 / 71.1 x 40.6 x 22.1 Shipping: 34.5 x 21 x 14.5 / 87.6 x 53.3 x 36.8	

Breaker Configuration Diagram

Holds up to eighteen 0.75" (19 mm) wide breakers, two 1.5" (39 mm) wide breakers and one FLEXnet DC. Support for optional AC Input-Output-Bypass Assembly. AC breakers are rated from 10-60A of AC current. A new double-pole 50A breaker is available to support 120/240V input and loads.

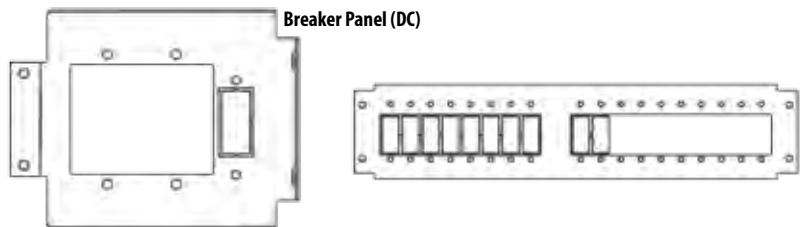

Breaker Panel (DC)



Radian™ Series GS Load Center

Balance-of-System Enclosure Specifications

Radian Series GS Load Center (GSLC)

The GSLC is a balance-of-systems enclosure designed to seamlessly integrate with the Radian Series inverter/chargers, FLEXmax charge controllers, and OutBack HUB communications manager. Three available models allow quick and easy installation of power systems of any size. Additional features of the GSLC line include its powder-coated galvanized chassis, ample knockout locations fitting 1/2" to 2" conduit, aesthetic stainless steel door and simple mounting to a Radian Series inverter/charger. It is listed to UL1741 and CSA C22.2 No. 107.1-01, is Type 1 indoor rated (IP30) and can also be used on its own as a separate breaker enclosure for use with other inverter models.

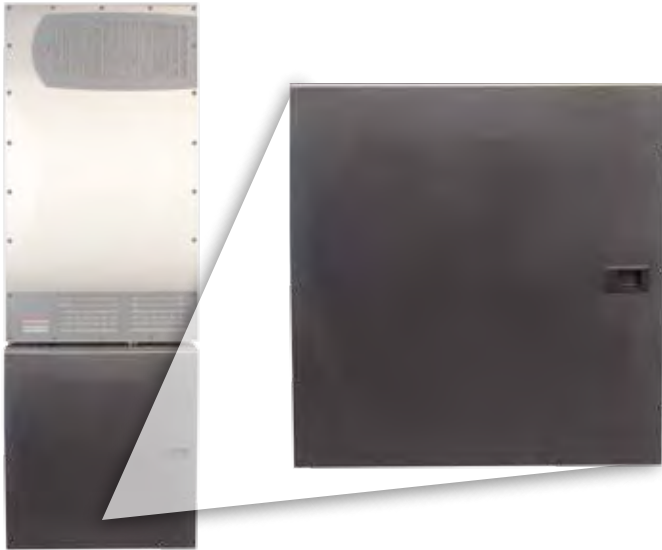

GSLC Knockout Location Diagram

Left Side	<ul style="list-style-type: none"> • (1) ½" knockout (0.875" diameter) • (7) 1" knockout (1.375" diameter) • (2) 2" knockout (2.468" diameter) 	
Right Side	<ul style="list-style-type: none"> • (1) ½" knockout (0.875" diameter) • (4) 1" knockout (1.375" diameter) • (2) 2" knockout (2.468" diameter) 	
Back Side	<ul style="list-style-type: none"> • (1) 2" knockout (2.468" diameter) 	
Bottom Side	<ul style="list-style-type: none"> • (2) ½" knockout (0.875" diameter) • (2) ¾" knockout (1.109" diameter) • (2) 1" knockout (1.375" diameter) • (2) 1¼" knockout (1.734" diameter) • (1) 1½" knockout (1.984" diameter) • (2) 2" knockout (2.468" diameter) 	
Top Side*	<ul style="list-style-type: none"> • (2) 1" knockout (1.375" diameter) • (2) 2" knockout (2.468" diameter) 	

GSLC Model Numbers

Installed Components	GSLC	GSLC175-AC-120/240	GSLC175-120/240	GSLC175-230	GSLC175-PV-120/240	GSLC175-PV-230	GSLC175-PV1-120/240	GSLC175-PV1-230
	Enclosure w/ Hinged Door	◆	◆	◆	◆	◆	◆	◆
175A Breakers		2	2	2	2	2	1	1
Dual AC Inputs		◆	◆	◆	◆	◆	◆	◆
GFDI					◆	◆	◆	◆
FLEXnet DC					◆	◆	◆	◆
PV Disconnects					2	2	1	1
500A DC Shunt	1	1	1	1	3	3	2	2
120/240VAC Bypass		◆	◆		◆		◆	
230VAC Bypass				◆		◆		◆
ROCB, 4-50A 120/240 Circuit Breakers, Sliding Bypass Interlock		◆						
Weight (lb/kg)	Unit: 26 / 11.8 Shipping: 34 / 15.4	Unit: 40 / 18.1** Shipping: 45 / 20.4	Unit: 37 / 16.8 Shipping: 45 / 20.4	Unit: 37 / 16.8 Shipping: 45 / 20.4	Unit: 40 / 18.1** Shipping: 45 / 20.4	Unit: 40 / 18.1** Shipping: 45 / 20.4	Unit: 40 / 18.1** Shipping: 45 / 20.4	Unit: 40 / 18.1** Shipping: 45 / 20.4
Recommended Radian Model	GS8048 GS8048A GS4048A GS7035E GS3548E	GS8048 GS8048A GS4048A	GS8048 GS8048A GS4048A	GS7048E	GS8048 GS8048A	GS7048E	GS4048A	GS3548E

*Not to be used with Radian Series inverter/charger. **Minimum



GTFX/GVFX Series

Grid-Interactive Sealed and Vented Inverter/Charger Introduction



OutBack Power's true sinewave grid-interactive inverter/chargers incorporate a DC to AC sinewave inverter, battery charger and AC transfer switch housed within a die-cast aluminum chassis.

A built-in transfer switch automatically disconnects your loads from the utility grid and powers them from the inverter in the event of an outage, allowing you to continue using your solar and battery backup power, unlike traditional grid-tied systems.

Intelligent multi-stage battery charging prolongs the life of your batteries and built-in networked communications enables you to stack up to two units while simultaneously communicating with other OutBack Power components. The modular system architecture means that increased power output is just an additional inverter/charger away.

Product Highlights:

- Sinewave Output
- Intelligent Battery Charging
- Bug-Proof Chassis
- Field Serviceable



OutBack Case Study—La Zebra Resort Featuring (6) GTFX Inverter/Chargers and MATE3 System Display and Communications

"Maintaining power off the grid is beyond a full-time job; so much so that there are many hotels on the beach that still can't offer 24-hour power. OutBack Power's inverters are incredible units that set us apart from the competition, cut our costs and contribute to a luxurious guest experience." —Greg Brown, Colibri Hotel Collection



GTFX/GVFX

Grid-Interactive 60Hz/120V Inverter/Chargers

Models:	Sealed Models		Vented Models	
	GTFX2524	GTFX3048	GVFX3524	GVFX3648
Nominal DC Input Voltage	24VDC	48VDC	24VDC	48VDC
Continuous Power Rating (@ 25°C)	2500VA	3000VA	3500VA	3600VA
AC Frequency/Voltage	60Hz / 120VAC	60Hz / 120VAC	60Hz / 120VAC	60Hz / 120VAC
Continuous AC RMS Output (@25°C)	20.8AAC	25AAC	29.2AAC	30AAC
Idle Power	Full: ~20W Search: ~6W	Full: ~23W Search: ~6W	Full: ~20W Search: ~6W	Full: ~23W Search: ~6W
Peak Efficiency	—	—	—	95%
Typical Efficiency	92%	93%	92%	93%
Total Harmonic Distortion	Typical: 2% Maximum: 5%	Typical: 2% Maximum: 5%	Typical: 2% Maximum: 5%	Typical: 2% Maximum: 5%
Output Voltage Regulation	±2%	±2%	±2%	±2%
Maximum Output Current	Peak: 70AAC RMS: 50AAC	Peak: 70AAC RMS: 50AAC	Peak: 70AAC RMS: 50AAC	Peak: 70AAC RMS: 50AAC
AC Overload Capacity	Surge: 6000VA 5 Seconds: 4800VA 30 Minutes: 3200VA	Surge: 6000VA 5 Seconds: 4800VA 30 Minutes: 3200VA	Surge: 6000VA 5 Seconds: 5000VA 30 Minutes: 4000VA	Surge: 6000VA 5 Seconds: 5000VA 30 Minutes: 4000VA
AC Input Current Maximum	60AAC	60AAC	60AAC	60AAC
Grid-Interactive Voltage Range*	108 to 132VAC	108 to 132VAC	108 to 132VAC	108 to 132VAC
Grid-Interactive Frequency Range*	59.3 to 60.5Hz	59.3 to 60.5Hz	59.3 to 60.5Hz	59.3 to 60.5Hz
AC Input Voltage Range	108 to 132VAC	108 to 132VAC	108 to 132VAC	108 to 132VAC
AC Input Frequency Range	55 to 65Hz	55 to 65Hz	55 to 65Hz	55 to 65Hz
DC Input Voltage Range	21 to 34VDC	42 to 68VDC	21 to 34VDC	42 to 68VDC
Maximum DC Current (@ Rated Power)	125ADC	75ADC	175ADC	90ADC
Continuous Battery Charger Output	55ADC	35ADC	85ADC	45ADC
Certifications	ETL Listed to UL1741, CSA C22.2 No. 107.1	ETL Listed to UL1741, CSA C22.2 No. 107.1	ETL Listed to UL1741, CSA C22.2 No. 107.1	ETL Listed to UL1741, CSA C22.2 No. 107.1
Temperature Range	Rated: 0 to 50°C (power derated above 25°C) Maximum**: -25 to 60°C		Rated: 0 to 50°C (power derated above 25°C) Maximum**: -25 to 60°C	
Warranty	Standard 5 year, available 10 year		Standard 5 year, available 10 year	
Weight (lb/kg)	Unit: 62 / 29 Shipping: 67 / 31		Unit: 61 / 28 Shipping: 67 / 31	
Dimensions H x W x L (in/cm)	Unit: 13 x 8.25 x 16.25 / 33 x 21 x 41 Shipping: 21.75 x 13 x 22 / 55 x 33 x 56		Unit: 12 x 8.25 x 16.25 / 30.5 x 21 x 41 Shipping: 21.75 x 13 x 22 / 55 x 33 x 56	

*This product was designed to meet UL1741 specifications within the US and Canada. Please check local nominal power voltage ratings in areas where grid specifications might fluctuate.

**Functions, but does not necessarily meet all component specifications.



GTX/GVFX

Grid-Interactive 60Hz/127V Inverter/Chargers for Mexico and Other Markets

60Hz/127V Models*:	GVFX3524LA	GVFX3648LA
Nominal DC Input Voltage	24VDC	48VDC
Continuous Power Rating (@ 25°C)	3500VA	3600VA
AC Frequency/Voltage	60Hz / 127VAC	60Hz / 127VAC
Continuous AC RMS Output (@25°C)	27.6AAC	28.4AAC
Idle Power	Full: ~23W Search: ~6W	Full: 20W Search: ~6W
Typical Efficiency	92%	93%
Total Harmonic Distortion	Inverting: 2% Selling: < 5%	Inverting: 2% Selling: < 5%
Output Voltage Regulation	±2%	±2%
Maximum Output Current	Peak: 70AAC RMS: 50AAC	Peak: 70AAC RMS: 50AAC
AC Overload Capacity	Surge: 6000VA 5 Seconds: 5000VA 30 Minutes: 4000VA	Surge: 6000VA 5 Seconds: 5000VA 30 Minutes: 4000VA
AC Input Current Maximum	60AAC	60AAC
AC Input Voltage Range (MATE Adjustable)	100 to 140VAC	100 to 140VAC
AC Input Frequency Range	58 to 62Hz	58 to 62Hz
DC Input Voltage Range	21 to 34VDC	42 to 68VDC
Continuous Battery Charger Output	85ADC	45ADC
Temperature Range	Rated: 0 to 50°C (power derated above 25°C) Maximum**: -25 to 60°C	Rated: 0 to 50°C (power derated above 25°C) Maximum**: -25 to 60°C
Warranty	Standard 5 year	Standard 5 year
Weight (lb/kg)	Unit: 61 / 28 Shipping: 67 / 31	Unit: 61 / 28 Shipping: 67 / 31
Dimensions H x W x L (in/cm)	Unit: 12 x 8.25 x 16.25 / 30.5 x 21 x 41 Shipping: 21.75 x 13 x 22 / 55 x 33 x 56	Unit: 12 x 8.25 x 16.25 / 30.5 x 21 x 41 Shipping: 21.75 x 13 x 22 / 55 x 33 x 56



GTFX/GVFX

Grid-Interactive 50Hz/230V Inverter/Chargers

50Hz/230V Models:	GVFX3024E	GVFX3048E
Nominal DC Input Voltage	24VDC	48VDC
Continuous Power Rating (@ 25°C)	3000VA	3000VA
AC Frequency/Voltage	50Hz / 230VAC	50Hz / 230VAC
Continuous AC RMS Output (@25°C)	13AAC	13AAC
Idle Power	Full: ~20W Search: ~6W	Full: ~23W Search: ~6W
Typical Efficiency	92%	93%
Total Harmonic Distortion	Typical: 2% Maximum: 5%	Typical: 2% Maximum: 5%
Output Voltage Regulation	±2%	±2%
Maximum Output Current	Peak: 35AAC RMS: 25AAC	Peak: 35AAC RMS: 25AAC
AC Overload Capacity	Surge: 5750VA 5 Seconds: 4800VA 30 Minutes: 3300VA	Surge: 5750VA 5 Seconds: 4800VA 30 Minutes: 3300VA
AC Input Current Maximum	30AAC	30AAC
AC Input Voltage Range (MATE Adjustable)	160 to 300VAC	160 to 300VAC
AC Input Frequency Range	44 to 56Hz	44 to 56Hz
DC Input Voltage Range	21 to 34VDC	42 to 68VDC
Continuous Battery Charger Output	85ADC	45ADC
Temperature Range	Rated: 0 to 50°C (power derated above 25°C) Maximum*: -25 to 60°C	Rated: 0 to 50°C (power derated above 25°C) Maximum*: -25 to 60°C
Warranty	Standard 5 year	Standard 5 year
Weight (lb/kg)	Unit: 61 / 28 Shipping: 67 / 31	Unit: 61 / 28 Shipping: 67 / 31
Dimensions H x W x L (in/cm)	Unit: 12 x 8.25 x 16.25 / 30.5 x 21 x 41 Shipping: 21.75 x 13 x 22 / 55 x 33 x 56	Unit: 12 x 8.25 x 16.25 / 30.5 x 21 x 41 Shipping: 21.75 x 13 x 22 / 55 x 33 x 56

*Functions, but does not necessarily meet all component specifications.



M-Series Mobile/Marine

Specialized Application 60Hz/120V Inverter/Chargers



OutBack's M-Series Mobile/Marine inverter/charger models provide high performance and reliability wherever your travels take you.

The die-cast metal construction allows mounting in any position, even upside down. The required AC input neutral/ground switching is taken care of by a fully-integrated 30AAC transfer switch for shore power or generator hook-up. Three circuit boards and a simple design allow simple field servicing in any location. Rigorous factory testing ensures each inverter/charger exhibits efficiency and reliability on the first day of operation, as well as for many years to come.

Product Highlights:

- True Sinewave Output
- Intelligent Battery Charging
- Modular, Stackable Design

Models:	Sealed Models					Vented Models				
	FX2012MT	FX2524MT	FX2532MT	FX2536MT	FX3048MT	VFX2812M	VFX3524M	VFX3232M	VFX3236M	VFX3648M
Nominal DC Input Voltage	12VDC	24VDC	32VDC	36VDC	48VDC	12VDC	24VDC	32VDC	36VDC	48VDC
Continuous Power Rating (@ 25°C)	2000VA	2500VA	2500VA	2500VA	3000VA	2800VA	3500VA	3200VA	3200VA	3600VA
AC Frequency/Voltage	60Hz / 120VAC	60Hz / 120VAC	60Hz / 120VAC	60Hz / 120VAC	60Hz / 120VAC	60Hz / 120VAC	60Hz / 120VAC	60Hz / 120VAC	60Hz / 120VAC	60Hz / 120VAC
Continuous AC RMS Output (@25°C)	17AAC	20.8AAC	20.8AAC	20.8AAC	25AAC	23.3AAC	29.2AAC	26.6AAC	26.6AAC	30AAC
Idle Power	Full: ~20W Search: ~6W	Full: ~20W Search: ~6W	Full: ~21W Search: ~6W	Full: ~21W Search: ~6W	Full: ~23W Search: ~6W	Full: ~20W Search: ~6W	Full: ~20W Search: ~6W	Full: ~21W Search: ~6W	Full: ~21W Search: ~6W	Full: ~23W Search: ~6W
Typical Efficiency	90%	92%	92%	92%	93%	90%	92%	92%	92%	93%
Total Harmonic Distortion	Typical: 2% Maximum: 5%	Typical: 2% Maximum: 5%	Typical: 2% Maximum: 5%	Typical: 2% Maximum: 5%	Typical: 2% Maximum: 5%	Typical: 2% Maximum: 5%	Typical: 2% Maximum: 5%	Typical: 2% Maximum: 5%	Typical: 2% Maximum: 5%	Typical: 2% Maximum: 5%
Output Voltage Regulation	±2%	±2%	±2%	±2%	±2%	±2%	±2%	±2%	±2%	±2%
Maximum Output Current	Peak: 56AAC RMS: 40AAC	Peak: 70AAC RMS: 50AAC	Peak: 56AAC RMS: 40AAC	Peak: 56AAC RMS: 40AAC	Peak: 70AAC RMS: 50AAC	Peak: 56AAC RMS: 40AAC	Peak: 70AAC RMS: 50AAC	Peak: 56AAC RMS: 40AAC	Peak: 56AAC RMS: 40AAC	Peak: 70AAC RMS: 50AAC
AC Overload Capacity	Surge: 4800VA 5 Sec: 4000VA 30 Min: 2500VA	Surge: 6000VA 5 Sec: 4800VA 30 Min: 3200VA	Surge: 4800VA 5 Sec: 4000VA 30 Min: 2500VA	Surge: 4800VA 5 Sec: 4000VA 30 Min: 2500VA	Surge: 6000VA 5 Sec: 4800VA 30 Min: 3200V	Surge: 4800VA 5 Sec: 4000VA 30 Min: 3200VA	Surge: 6000VA 5 Sec: 5000VA 30 Min: 4000V	Surge: 4800VA 5 Sec: 4000VA 30 Min: 4000VA	Surge: 4800VA 5 Sec: 4000VA 30 Min: 2500VA	Surge: 6000VA 5 Sec: 5000VA 30 Min: 4000V
AC Input Current Maximum	30AAC	30AAC	30AAC	30AAC	30AAC	30AAC	30AAC	30AAC	30AAC	30AAC
AC Input Voltage Range (MATE Adjustable)	80 to 150VAC	80 to 150VAC	80 to 150VAC	80 to 150VAC	80 to 150VAC	80 to 150VAC	80 to 150VAC	80 to 150VAC	80 to 150VAC	80 to 150VAC
AC Input Frequency Range	54 to 66Hz	54 to 66Hz	54 to 66Hz	54 to 66Hz	54 to 66Hz	54 to 66Hz	54 to 66Hz	54 to 66Hz	54 to 66Hz	54 to 66Hz
Neutral-Ground Bond Switching	Yes	Yes	Yes	Yes	Yes	Yes	Yes	Yes	Yes	Yes
DC Input Voltage Range	10.5 to 17VDC	21 to 34VDC	28 to 45.3VDC	31.5 to 51VDC	42 to 68VDC	10.5 to 17VDC	21 to 34VDC	28 to 45.3VDC	31.5 to 51VDC	42 to 68VDC
Continuous Battery Charger Output	80ADC	55ADC	35ADC	35ADC	35ADC	125ADC	85ADC	45ADC	45ADC	45ADC
Temperature Range	Rated: 0 to 50°C (power derated above 25°C) Maximum*: -25 to 60°C					Rated: 0 to 50°C (power derated above 25°C) Maximum*: -25 to 60°C				
Certifications	ETL Listed to UL458					ETL Listed to UL458				
Warranty	Standard 5 year					Standard 5 year				
Weight (lb/kg)	Unit: 62 / 29 Shipping: 67 / 31					Unit: 61 / 28 Shipping: 67 / 31				
Dimensions H x W x L (in/cm)	Unit: 13 x 8.25 x 16.25 / 33 x 21 x 41 Shipping: 21.75 x 13 x 22 / 55 x 33 x 56					Unit: 12 x 8.25 x 16.25 / 30.5 x 21 x 41 Shipping: 21.75 x 13 x 22 / 55 x 33 x 56				



M-Series Mobile/Marine

Specialized Application 50Hz/230V Inverter/Chargers

Models:	Sealed Models			Vented Models		
	FX2012EMT	FX2024EMT	FX2348EMT	VFX2612EM	VFX3024EM	VFX3048EM
Nominal DC Input Voltage	12VDC	24VDC	48VDC	12VDC	24VDC	48VDC
Continuous Power Rating (@ 25°C)	2000VA	2000VA	2300VA	2600VA	3000VA	3000VA
AC Frequency/Voltage	50Hz / 230VAC	50Hz / 230VAC	50Hz / 230VAC	50Hz / 230VAC	50Hz / 230VAC	50Hz / 230VAC
Continuous AC RMS Output (@25°C)	8.7AAC	8.7AAC	10AAC	11.3AAC	13AAC	13AAC
Idle Power	Full: ~20W Search: ~6W	Full: ~20W Search: ~6W	Full: ~23W Search: ~6W	Full: ~20W Search: ~6W	Full: ~20W Search: ~6W	Full: ~23W Search: ~6W
Typical Efficiency	90%	92%	93%	90%	92%	93%
Total Harmonic Distortion	Typical: 2% Maximum: 5%	Typical: 2% Maximum: 5%	Typical: 2% Maximum: 5%	Typical: 2% Maximum: 5%	Typical: 2% Maximum: 5%	Typical: 2% Maximum: 5%
Output Voltage Regulation	±2%	±2%	±2%	±2%	±2%	±2%
Maximum Output Current	Peak: 28AAC RMS: 25AAC	Peak: 35AAC RMS: 25AAC	Peak: 35AAC RMS: 25AAC	Peak: 28AAC RMS: 20AAC	Peak: 35AAC RMS: 25AAC	Peak: 35AAC RMS: 25AAC
AC Overload Capacity	Surge: 4600VA 5 Seconds: 4000VA 30 Minutes: 2500VA	Surge: 5750VA 5 Seconds: 4800VA 30 Minutes: 3100VA	Surge: 5750VA 5 Seconds: 4800VA 30 Minutes: 3100VA	Surge: 4600VA 5 Seconds: 4000VA 30 Minutes: 3100VA	Surge: 5750VA 5 Seconds: 4800VA 30 Minutes: 3300VA	Surge: 5750VA 5 Seconds: 4800VA 30 Minutes: 3300VA
AC Input Current Maximum	30AAC	30AAC	30AAC	30AAC	30AAC	30AAC
AC Input Voltage Range (MATE Adjustable)	160 to 300VAC	160 to 300VAC	160 to 300VAC	160 to 300VAC	160 to 300VAC	160 to 300VAC
AC Input Frequency Range	44 to 56Hz	44 to 56Hz	44 to 56Hz	44 to 56Hz	44 to 56Hz	44 to 56Hz
Neutral-Ground Bond Switching	Yes	Yes	Yes	Yes	Yes	Yes
DC Input Voltage Range	10.5 to 17VDC	21 to 34VDC	42 to 68VDC	10.5 to 17VDC	21 to 34VDC	42 to 68VDC
Continuous Battery Charger Output	100ADC	55ADC	35ADC	120ADC	85ADC	45ADC
Temperature Range	Rated: 0 to 50°C (power derated above 25°C) Maximum*: -25 to 60°C			Rated: 0 to 50°C (power derated above 25°C) Maximum*: -25 to 60°C		
Warranty	Standard 5 year			Standard 5 year		
Weight (lb/kg)	Unit: 62 / 29 Shipping: 67 / 31			Unit: 61 / 28 Shipping: 67 / 31		
Dimensions H x W x L (in/cm)	Unit: 13 x 8.25 x 16.25 / 33 x 21 x 41 Shipping: 21.75 x 13 x 22 / 55 x 33 x 56			Unit: 12 x 8.25 x 16.25 / 30.5 x 21 x 41 Shipping: 21.75 x 13 x 22 / 55 x 33 x 56		



OutBack Case Study—Nordhavn Yachts Featuring M-Series Mobile/Marine Inverter/Chargers and FLEXmax Charge Controllers

"OutBack Power allows us to design electrical systems that meet the marine-quality demands of our customers. The company provides versatile devices that bring a measurable level of reliability, convenience and safety to every one of our boats." —Mike Telleria, Nordhavn Yachts

*Functions, but does not necessarily meet all component specifications.



OBX Extreme Series

Specialized Application 60Hz/120V Inverter/Chargers



Built from exceptionally rugged components not available in regular commercial “off-the-shelf” inverter/chargers, the water-resistant OBX Extreme Series inverter/chargers are designed to survive harsh environmental conditions including shock and vibration.

Additional features of the OBX include intelligent battery charging and an integrated AC transfer relay with automatic neutral-ground switching for mobile applications. A “mount anywhere” design and silent operation, along with low-distortion pure sinewave power output, makes the OBX ideal for mobile electrical needs, and their ample surge capability can start multiple heavy loads simultaneously.

Product Highlights:

- Highly Reliable, All-in-One Power Solutions
- True Sinewave AC Output
- Efficient Battery Charging
- High Surge Power Capability

Models:	OBXIC2024S120/60*	OBXGIC2524P120/60	OBXIC3524P120/60
Nominal DC Input Voltage	24VDC	24VDC	24VDC
Continuous Power Rating (@ 25°C)	2000VA	2500VA	3500VA
AC Frequency/Voltage	60Hz / 120VAC	60Hz / 120VAC	60Hz / 120VAC
Continuous AC RMS Output (@25°C)	16.7AAC	20.8AAC	29.2AAC
Idle Power	Full: ~20W Search: ~6W	Full: ~20W Search: ~6W	Full: 20W Search: ~6W
Typical Efficiency	92%	92%	92%
Total Harmonic Distortion	Typical: 2% Maximum: 5%	Typical: 2% Maximum: 5%	Typical: 2% Maximum: 5%
Output Voltage Regulation	±2%	±2%	±2%
Maximum Output Current	Peak: 70AAC RMS: 50AAC	Peak: 70AAC RMS: 50AAC	Peak: 70AAC RMS: 50AAC
AC Overload Capacity	Surge: 6000VA 5 Sec: 4800VA 30 Min: 3200VA	Surge: 6000VA 5 Sec: 4800VA 30 Min: 3200VA	Surge: 6000VA 5 Sec: 5000VA 30 Min: 4000V
AC Input Current Maximum	30AAC	30AAC	30AAC
AC Input Voltage Range (MATE Adjustable)	80 to 150VAC	80 to 150VAC	80 to 150VAC
AC Input Frequency Range	54 to 66Hz	54 to 66Hz	54 to 66Hz
DC Input Voltage Range	21 to 34VDC	21 to 34VDC	21 to 34VDC
Continuous Battery Charger Output	55ADC	55ADC	85ADC
Recommended Battery Cable	#2/0 AWG	#2/0 AWG	#2/0 AWG
Recommended Battery Types	Flooded Lead Acid, AGM, Gel	Flooded Lead Acid, AGM, Gel	Flooded Lead Acid, AGM, Gel
Neutral-Ground Bond Switching	Yes	Yes	
Chassis	Sealed / fordable	Sealed	Vented
Temperature Range	Rated: 0 to 50°C (power derated above 25°C) Maximum**: -25 to 60°C	Rated: 0 to 50°C (power derated above 25°C) Maximum**: -25 to 60°C	Rated: 0 to 50°C (power derated above 25°C) Maximum**: -25 to 60°C
Warranty	Standard 5 year	Standard 5 year	Standard 5 year
Weight (lb/kg)	Unit: 57.5 / 26 Shipping: 65 / 29.5	Unit: 62 / 29 Shipping: 67 / 31	Unit: 62 / 29 Shipping: 67 / 31
Dimensions H x W x L (in/cm)	Unit: 12 x 8.25 x 16.25 / 33 x 21 x 41 Shipping: 21.75 x 13 x 22 / 55 x 33 x 56	Unit: 12 x 8.25 x 16.25 / 33 x 21 x 41 Shipping: 21.75 x 13 x 22 / 55 x 33 x 56	Unit: 12 x 8.25 x 16.25 / 33 x 21 x 41 Shipping: 21.75 x 13 x 22 / 55 x 33 x 56



OBX Extreme Series

Specialized Application 50Hz/230V Inverter/Chargers

Models: OBXIC2024P230/50

Nominal DC Input Voltage	24VDC
Continuous Power Rating (@ 25°C)	2000VA
AC Frequency / Voltage	50Hz / 230VAC
Continuous AC RMS Output (@25°C)	8.7AAC
Idle Power	Full: ~20W Search: ~6W
Typical Efficiency	92%
Total Harmonic Distortion	Typical: 2% Maximum: 5%
Output Voltage Regulation	±2%
Maximum Output Current	Peak: 35AAC RMS: 25AAC
AC Overload Capacity	Surge: 5750VA 5 Sec: 4800VA 30 Min: 3100VA
AC Input Current Maximum	30AAC
AC Input Voltage Range (MATE Adjustable)	160 to 300VAC
AC Input Frequency Range	44 to 56Hz
DC Input Voltage Range	21 to 34VDC
Continuous Battery Charger Output	55ADC
Recommended Battery Cable	#2/0 AWG
Recommended Battery Types	Flooded Lead Acid, AGM, Gel
Neutral-Ground Bond Switching	Yes
Chassis	Sealed
Temperature Range	Rated: 0 to 50°C (power derated above 25°C) Maximum*: -25 to 60°C
Warranty	Standard 1 year
Weight (lb/kg)	Unit: 62 / 29 Shipping: 67 / 31
Dimensions H x W x L (in/cm)	Unit: 12 x 8.25 x 16.25 / 33 x 21 x 41 Shipping: 21.75 x 13 x 22 / 55 x 33 x 56



OutBack Case Study—Army M-113 Featuring OBX Inverter/Charger

OutBack OBX Extreme Series inverterchargers serve with the U.S. Army's M-113 armored personnel carrier.

Note: All OBX models meet clauses related to DC transients for wheeled and tracked profiles in MIL-STD-1275D.
*Functions, but does not necessarily meet all component specifications.



GFX International Series

Limited Power Specialized Application 60Hz/120V Sealed Inverter/Chargers



The OutBack true sine wave GFX International Series inverter/charger is a competitive power solution designed for applications with lower power demands.

Incorporating a DC to AC sinewave inverter, battery charger and AC transfer relay housed within a die-cast aluminum chassis, the GFX International Series inverter/charger gives you the ability to sell solar, wind or hydro power back to the utility grid while providing instantaneous backup power in the event of a utility outage.

The GFX International Series' built-in transfer relay automatically disconnects your loads from the utility grid and powers them from the inverter in the event of an outage, allowing you to continue using your solar and battery backup power (unlike traditional grid-tied systems). For areas that frequently experience power instability such as surges, spikes or brownouts, or where standard inverters have trouble syncing to the utility grid, the GFX International Series grid reconnect timers have been shortened to reduce overall sell-back downtime and improve system functionality.

Product Highlights:

- For Grid-Tied, Backup or Standalone Power Applications
- True Sinewave Output
- Intelligent Battery Charging with Generator Support
- Sealed Chassis for Harsh Environments

Models*:	GFX1312	GFX1424	GFX1548
Nominal DC Input Voltage	12VDC	24VDC	48VDC
Continuous Power Rating (@ 25°C)	1300VA	1400VA	1500VA
AC Frequency/Voltage	60Hz / 120VAC	60Hz / 120VAC	60Hz / 120VAC
Continuous AC RMS Output (@ 25°C)	10.83AAC	11.66AAC	12.5AAC
Idle Power	Full: ~18W Search: ~6W	Full: ~18W Search: ~6W	Full: ~18W Search: ~6W
Typical Efficiency	90%	92%	93%
Total Harmonic Distortion	Typical: 2% Maximum: 5%	Typical: 2% Maximum: 5%	Typical: 2% Maximum: 5%
Output Voltage Regulation	±2%	±2%	±2%
Maximum Output Current	Peak: 56AAC RMS: 40AAC	Peak: 56AAC RMS: 40AAC	Peak: 56AAC RMS: 40AAC
AC Overload Capacity	Surge: 4600VA 5 Sec: 2900VA 30 Min: 1800VA	Surge: 4600VA 5 Sec: 2900VA 30 Min: 2000VA	Surge: 4600VA 5 Sec: 2900VA 30 Min: 2000VA
AC Input Current Maximum	60AAC	60AAC	60AAC
AC Input Voltage Range (Adjustable)	70 to 140VAC	70 to 140VAC	70 to 140VAC
AC Input Frequency Range	54 to 66Hz	54 to 66Hz	54 to 66Hz
DC Input Voltage Range	10.5 to 17VDC	21 to 34VDC	42 to 68VDC
Continuous Battery Charger Output	70ADC	40ADC	20ADC
Maximum DC Current at Rated Power	130ADC	70ADC	37.5ADC
Temperature Range	Rated: 0 to 50°C (power derated above 25°C) Maximum**:-25 to 60°C	Rated: 0 to 50°C (power derated above 25°C) Maximum**:-25 to 60°C	Rated: 0 to 50°C (power derated above 25°C) Maximum**:-25 to 60°C
Warranty	Standard 5 year	Standard 5 year	Standard 5 year
Weight (lb/kg)	Unit: 49.6 / 22.5 Shipping: 56.4 / 25.6	Unit: 49.6 / 22.5 Shipping: 56.4 / 25.6	Unit: 49.6 / 22.5 Shipping: 56.4 / 25.6
Dimensions H x W x L (in/cm)	Unit: 12 x 8.25 x 16.25 / 33 x 21 x 41 Shipping: 21.75 x 13 x 22 / 55 x 33 x 56	Unit: 12 x 8.25 x 16.25 / 33 x 21 x 41 Shipping: 21.75 x 13 x 22 / 55 x 33 x 56	Unit: 12 x 8.25 x 16.25 / 33 x 21 x 41 Shipping: 21.75 x 13 x 22 / 55 x 33 x 56



GFX International Series

Limited Power Specialized Application 50Hz/230V Sealed Inverter/Chargers

Models:	GFX1312E	GFX1424E	GFX1448E
Nominal DC Input Voltage	12VDC	24VDC	48VDC
Continuous Power Rating (@ 25°C)	1300VA	1400VA	1400VA
AC Frequency/Voltage	50Hz / 230VAC	50Hz / 230VAC	50Hz / 230VAC
Continuous AC RMS Output (@25°C)	5.65AAC	6.09AAC	6.09AAC
Idle Power	Full: ~18W Search: ~6W	Full: ~18W Search: ~6W	Full: ~18W Search: ~6W
Typical Efficiency	90%	92%	93%
Total Harmonic Distortion	Typical: 2% Maximum: 5%	Typical: 2% Maximum: 5%	Typical: 2% Maximum: 5%
Output Voltage Regulation	±2%	±2%	±2%
Maximum Output Current	Peak: 28AAC RMS: 20AAC	Peak: 28AAC RMS: 20AAC	Peak: 28AAC RMS: 20AAC
AC Overload Capacity	Surge: 4600VA 5 Sec: 2900VA 30 Min: 1800VA	Surge: 4600VA 5 Sec: 2900VA 30 Min: 2000VA	Surge: 4600VA 5 Sec: 2900VA 30 Min: 2000VA
AC Input Current Maximum	30AAC	30AAC	30AAC
AC Input Voltage Range (Adjustable)	140 to 280VAC	140 to 280VAC	140 to 280VAC
AC Input Frequency Range	45 to 55Hz	45 to 55Hz	45 to 55Hz
Grid-Interactive Frequency Range (Default)	48 to 52Hz	48 to 52Hz	48 to 52Hz
Grid-Interactive Voltage Range (Default)	208 to 252VAC	208 to 252VAC	208 to 252VAC
DC Input Voltage Range	10.5 to 17VDC	21 to 34VDC	42 to 68VDC
Continuous Battery Charger Output	70ADC	40ADC	20ADC
Maximum DC Current at Rated Power	130ADC	70ADC	35ADC
Temperature Range	Rated: 0 to 50°C (power derated above 25°C) Maximum*: -25 to 60°C	Rated: 0 to 50°C (power derated above 25°C) Maximum*: -25 to 60°C	Rated: 0 to 50°C (power derated above 25°C) Maximum*: -25 to 60°C
Warranty	Standard 5 year	Standard 5 year	Standard 5 year
Weight (lb/kg)	Unit: 49.6 / 22.5 Shipping: 56.4 / 25.6	Unit: 49.6 / 22.5 Shipping: 56.4 / 25.6	Unit: 49.6 / 22.5 Shipping: 56.4 / 25.6
Dimensions H x W x L (in/cm)	Unit: 12 x 8.25 x 16.25 / 33 x 21 x 41 Shipping: 21.75 x 13 x 22 / 55 x 33 x 56	Unit: 12 x 8.25 x 16.25 / 33 x 21 x 41 Shipping: 21.75 x 13 x 22 / 55 x 33 x 56	Unit: 12 x 8.25 x 16.25 / 33 x 21 x 41 Shipping: 21.75 x 13 x 22 / 55 x 33 x 56

*Functions, but does not necessarily meet all component specifications.



FLEXmax™ Series

Charge Controllers



FLEXmax 80



FLEXmax 60

The FLEXmax family of charge controllers is the latest innovation in Maximum Power Point Tracking (MPPT) charge controllers from OutBack Power. The innovative FLEXmax MPPT software algorithm is both continuous and active, increasing your photovoltaic array power yield up to 30% compared to non-MPPT controllers. Thanks to active cooling and intelligent thermal management cooling, both FLEXmax charge controllers can operate at their full maximum current rating, 60A or 80A respectively, in ambient temperatures as high as 104°F (40°C).

Included in all of the FLEXmax charge controllers are the revolutionary features first developed by OutBack Power, including support for a wide-range of nominal battery voltages and the ability to step-down a higher voltage solar array to recharge a lower voltage battery bank. A built-in, backlit 80 character display shows the current status and logged system performance data for the last 128 days at the touch of a button.

The integrated OutBack network communications allows FLEXmax Series charge controllers to be remotely programmed and monitored via a MATE system display and provides unrivaled complete system integration.

Product Highlights:

- 60A and 80A Models Available
- Active Cooling for Extreme Temperatures
- Wide Input Voltage Range



OutBack Case Study—NASA Antarctic Impulse Transient Antenna Array (ANITA) Featuring FLEXmax 60 Charge Controller

NASA uses a specially-modified OutBack FLEXmax 60 charge controller to go along on every ANITA mission to ensure optimum on-board power management which is essential to a successful mission.



FLEXmax™ Series

Charge Controllers

OPTIMIZE WITH



OPTICS_{RE}

Models*:	FLEXmax 80 (FM80-150VDC)	FLEXmax 60 (FM60-150VDC)
Nominal Battery Voltages	12, 24, 36, 48, or 60VDC (Single model, selectable via field programming at start-up)	12, 24, 36, 48, or 60VDC (Single model, selectable via field programming at start-up)
Maximum Output Current	80A @ 104°F (40°C) with adjustable current limit	60A @ 104°F (40°C) with adjustable current limit
NEC Recommended Solar Maximum Array STC Nameplate	12VDC systems: 1000W / 24VDC systems: 2000W 48VDC systems: 4000W / 60VDC systems: 5000W	12VDC systems: 750W / 24VDC systems: 1500W 48VDC systems: 3000W / 60VDC systems: 3750W
PV Open Circuit Voltage (VOC)	150VDC absolute maximum coldest conditions / 145VDC start-up and operating maximum	150VDC absolute maximum coldest conditions / 145VDC start-up and operating maximum
Standby Power Consumption	Less than 1W typical	Less than 1W typical
Power Conversion Efficiency	97.5% @ 80ADC in a 48VDC System (typical)	98.1% @ 60ADC in a 48VDC System (typical)
Peak Efficiency	60VDC input w/48V battery at 53.1VDC (98.44%)	68VDC input w/48V battery at 52.8VDC (98.31%)
Charging Regulation	Bulk, absorption, float, silent and equalization	Bulk, absorption, float, silent and equalization
Voltage Regulation Set points	13 to 80VDC user adjustable with password protection	13 to 80VDC user adjustable with password protection
Equalization Charging	Programmable voltage setpoint and duration, automatic termination when completed	Programmable voltage setpoint and duration, automatic termination when completed
Battery Temperature Compensation	Automatic with optional RTS installed / 5.0mV per °C per 2V battery cell	Automatic with optional RTS installed / 5.0mV per °C per 2V battery cell
Voltage Step-Down Capability	Down convert from any acceptable array voltage to any battery voltage. Example: 72VDC array to 24VDC battery; 60VDC array to 48VDC battery	
Programmable Auxiliary Control Output	12VDC output signal which can be programmed for different control applications (maximum of 0.2ADC)	
Status Display	3.1" (8 cm) backlit LCD screen, 4 lines with 80 alphanumeric characters total	3.1" (8 cm) backlit LCD screen, 4 lines with 80 alphanumeric characters total
Remote Display and Controller	Optional MATE3, MATE or MATE2	Optional MATE3, MATE or MATE2
Network Cabling	Proprietary network system using RJ-45 modular connectors with CAT5 cable (8 wires)	Proprietary network system using RJ-45 modular connectors with CAT5 cable (8 wires)
Data Logging	Last 128 days of operation: amp-hours, watt-hours, time in float, peak watts, amps, solar array voltage, max. battery voltage, min. battery voltage and absorb time, accumulated amp-hours, and kWh of production	
Operating Temperature Range	-40 to 60°C (power automatically derated above 40°C)	-40 to 60°C (power automatically derated above 40°C)
Environmental Rating	Indoor Type 1	Indoor Type 1
Conduit Knockouts	One 1" (25.4mm) on the back; One 1" (25.4mm) on the left side; Two 1" (25.4mm) on the bottom	One 1" (25.4mm) on the back; One 1" (25.4mm) on the left side; Two 1" (25.4mm) on the bottom
Warranty	Standard 5-year / Available 10-year	Standard 5-year / Available 10-year
Weight (lb/kg)	Unit: 12.20 / 5.53 Shipping: 15.5 / 7	Unit: 11.65 / 5.3 Shipping: 14.9 / 6.8
Dimensions H x W x D (in/cm)	Unit: 16.25 x 5.75 x 4.5 / 41.3 x 14.6 x 11.4 Shipping: 19 x 9.5 x 8.5 / 48.3 x 24.1 x 21.6	Unit: 13.75 x 5.75 x 4.5 / 35 x 14.6 x 11.4 Shipping: 17 x 9.5 x 8.5 / 43.2 x 24.1 x 21.6
Options	Remote Temperature Sensor (RTS), HUB4, HUB10, MATE, MATE2, MATE3	Remote Temperature Sensor (RTS), HUB4, HUB10, MATE, MATE2, MATE3
Menu Languages	English & Spanish	English & Spanish
Certifications	ETL Listed to UL1741, CSA C22.2 No. 107.1	ETL Listed to UL1741, CSA C22.2 No. 107.1

*Use appropriate wire size in accordance with NEC.



FLEXmax™ Extreme

Charge Controller



The OutBack FLEXmax Extreme: A sealed, outdoor-rated charge controller with unprecedented thermal management capabilities designed for the most extreme environmental conditions.

The FLEXmax Extreme is engineered around the concept that the strongest chain is one with no weak links. In the case of charge controller design, the weak link is typically the cooling fan. Removing the fan removes the greatest obstacle to long service life and high reliability, as fan problems severely limit power output.

Because the FLEXmax Extreme's passively cooled unit can be sealed, circuit boards and other sensitive electronics can be fully protected from dust, dirt, insects, and other external sources of contamination.

Installer features of the FLEXmax Extreme include "ground agnostic" design to support negative, positive and floating ground systems, increased wire-bending space, oversized terminals for easier installation and mechanical design that permits servicing and replacing all power components while the unit is mounted on a wall and attached to conduit.

The FLEXmax Extreme charge controller is a fitting companion to OutBack's renowned sealed FXR inverter/charger line and demonstrates the company's ongoing commitment to providing clean, reliable power anywhere it has the potential to transform lives.

Product Highlights:

- Environmentally-Rated Sealed Enclosure
- Solid-State, Passively Cooled Design
- Multi-Voltage Maximum Power Point Tracking



OutBack FLEXmax Extreme—Rugged Equipment to Meet the Demand of Rugged Environments

When down-time is not an option, sealed equipment like the OutBack FLEXmax Extreme is the clear choice for reliability, performance and durability. OutBack's FLEXmax Extreme charge controller features the first sealed design of its kind, maximizing installation flexibility.



FLEXmax™ Extreme

Charge Controller

Model:	FLEXmax Extreme
Nominal DC Input Voltage	12, 24, 36, 48 or 60VDC (Automatic adjustment at start-up)
Maximum Output Current	80A @ 45°C / 113°F with adjustable current limit
PV Open Circuit Voltage (VOC)	150VDC absolute maximum coldest conditions / 145VDC start-up and operating maximum
NEC Recommended Maximum (Solar Array STC Nameplate)	12VDC systems: 1000W 24VDC systems: 2000W 48VDC systems: 4000W 60VDC systems: 5000W
Standby Power Consumption	Less than 1W typical
Charging Regulation	Bulk, absorption, float, silent and equalization
Typical Power Conversion Efficiency	98% @ 60ADC in a 48VDC system
Equalization Charging	Programmable voltage setpoint and duration, automatic termination when complete
Remote Battery Voltage Sense	Yes
Voltage Regulation Setpoints	13 to 80VDC
Battery Temperature Compensation	Automatic with optional RTS installed
Battery Temperature Compensation Slope	Adjustable 2.0 to 6.0mV per °C per 2V battery cell (5mV default)
Equalization Charging	Programmable voltage setpoint and duration—automatic termination when completed
Voltage Step-Down Capability	Down convert from any acceptable array voltage to any battery voltage. Examples: 72VDC array to 24VDC battery; 60VDC array to 48VDC battery
Programmable Auxiliary Control Output	12VDC output signal which can be programmed for different control applications (maximum of 0.25ADC)
Remote Display and Controller	Optional MATE3 or AXS Port
Data Logging	Last 128 days of operation: amp-hours, watt-hours, time in float, peak watts, amps, solar array voltage, max. battery voltage, min. battery voltage and absorb time, accumulated amp-hours, and kWh of production
Positive Ground Application	Requires dual-pole circuit breaker for switching both positive and negative conductors on PV input
Operating Temperature Range	-40 to 60°C (Full power output -20 to 45°C with passive cooling, -20 to 55°C with Turbo Fan option)
Environmental Rating	IP54 / NEMA 3R
Conduit Knockouts	One 1" trade size (25.4mm) on both left and right sides; one on the back; two on the bottom
Warranty	Standard 5 year / available 10 year
Weight (lb/kg)	Unit: 22.6 / 10.23 Shipping: 26.0 / 11.79
Dimensions H x W x D (in/cm)	Unit: 18.56 x 8.8 x 6.0 / 47.1 x 22.4 x 15.2 Shipping: 9.69 x 11.75 x 22.75 / 24.6 x 29.8 x 57.8
Non-Volatile Memory	Yes
Field Upgradable Firmware	Yes
Certifications	UL1741, CSA C22.2 No. 107.1, EN 50178, AS/NZS 3100, EN 61000-6-1, EN 61000-6-3, EN 55022, IEC 62109-1, FCC Class B, RoHS, CE
Optional Accessories	AXS Port: OutBack Modbus/TCP Interface card for remote system communication and control using Modbus over Ethernet (card only, for FLEXmax Extreme only) FLEXmax Extreme Fan: External fan kit RTS: Remote Temperature Sensor



ENERGYcell
106RE Top Terminal Battery

OutBack Power

OutBack ENERGYcell
PowerSafe
SBS 170F



STORE THE ENERGY

EnergyCell Batteries

Energy Storage Introduction	40-41
Energy Storage Matrix	42
EnergyCell RE Front & Top Terminal	43
EnergyCell RE High Capacity	44
EnergyCell GH	45
EnergyCell NC Front & Top Terminal	46
EnergyCell NC High Capacity	47
EnergyCell OPzV	48

Racks/Enclosures

Integrated Battery Racks	49
Indoor Battery Enclosures	50
Outdoor Battery Enclosures	51-52

FLEXcoupled Solution

Adding Energy Storage to Existing Radian Inverter/Charger	53
---	-----------



STORE THE ENERGY

ACHIEVE TRUE ENERGY INDEPENDENCE WITH OUTBACK POWER

OutBack Power has consistently offered reliable, high-quality, cutting-edge power conversion electronics.

OutBack continues its pioneering heritage by offering a full-line of energy storage solutions. From batteries to pre-assembled and pre-wired racks and enclosures, OutBack has an energy storage solution for virtually any application.



OutBack Energy Storage Benefits

1 ONE-BRAND SYSTEM SOLUTION

OutBack Power is the only single brand with a UL-1741 end-to-end solution, from batteries and rack to rooftop. For installers this means one stop shopping and a single point of contact for technical and support needs.

2 INTEGRATED APPROACH

OutBack engineering saves installers valuable time and money on the job, with pre-assembled and pre-wired battery rack solutions and quick connection front terminal architecture.

3 RELIABILITY AND PERFORMANCE

OutBack's battery line incorporates nothing but the best technologies, materials and designs including pure metal composition and Absorbed Glass Mat VRLA construction to deliver longer service life, superior shelf life, higher cycle life and maintenance-free operation.

4 BRAND ASSURANCE

Installers who want to instill the highest possible confidence in their work can count on OutBack's brand awareness with their customers, leveraging OutBack's expertise and reputation in mission-critical installations around the globe in every system they spec-in.

5 COMPLETE SOLUTION

OutBack offers a full range of options ideal for nearly any energy storage application. From small, grid-tied to full off-grid, OutBack EnergyCell batteries provide solutions for light commercial, residential and high capacity installations.

6 INDUSTRY LEADING LOGISTICS

Including the OnSite Direct battery shipment program, where selected models of factory fresh batteries ship from OutBack directly to the job site within ten days of order approval and always with free shipping (exclusions apply).

EnergyCell® Batteries

RE SERIES FRONT TERMINAL, TOP TERMINAL & HIGH CAPACITY

The EnergyCell RE is designed for high power density and renewable energy cycling applications. These batteries utilize Absorbed Glass Mat (AGM) technology for efficient gas recombination and freedom from electrolyte maintenance.

GH SERIES FRONT TERMINAL / HIGH CAPACITY

The EnergyCell GH is designed for Grid/Hybrid storage applications. Incorporating Thin Plate Pure Lead Advanced Glass Mat (TPPL AGM) allows for greater shelf life, extended float service life in optimal operating conditions, and higher energy density.

NC SERIES FRONT TERMINAL, TOP TERMINAL & HIGH CAPACITY

The EnergyCell Nano-Carbon advanced technology batteries allow for extended life in Partial State of Charge (PSoC) and self-consumption applications and can maximize overall cycle life by up to 44%.

OPZV SERIES HIGH CAPACITY

The EnergyCell OPzV offers the highest level of reliability and performance for installations with long discharges. Robust construction, state-of-the-art manufacturing and maintenance-free design make EnergyCell OPzV batteries an ideal solution for demanding applications.

Enclosures and Racking

ENCLOSURES FOR INDOOR AND OUTDOOR USE

Designed to work seamlessly with EnergyCell RE, GH and NC top terminal batteries, the OutBack IBE and OBE are ideal solutions for elegant battery storage. All IBE's and OBE's ship pre-assembled eliminating the need for costly onsite assembly.

RACKING FOR INDOOR USE

The Integrated Battery Rack (IBR) is designed for use with all EnergyCell RE, GH and NC front terminal batteries. Factory pre-wired and shipped fully assembled, the rugged, powder-coated IBR represents a simple and professional solution.

Make the Power, Store the Energy, Manage the System.

OutBack power electronics are the industry standard for off-grid and Grid/Hybrid renewable energy applications. That same expertise is leveraged in every OutBack energy storage solution. From batteries to racks to enclosures, **OutBack is the manufacturer that offers the simplicity of a single-brand solution.**



"We were particularly impressed with OutBack's EnergyCell RE High Capacity battery system. For an installation which must perform, there is simply no better choice."

—Jim McGrath, Sustainable Laramie LLC



The OutBack IBR is a comprehensive, pre-assembled battery rack that is easy-to-install, is crafted of powdercoated steel and holds up to 12 EnergyCell RE, GH or NC front terminal batteries.





Energy Storage Matrix

EnergyCell Batteries, Enclosures and Racks from OutBack Power

ENERGYCELL BATTERIES	DEEP CYCLE	SELF-CONSUMPTION	EMERGENCY BACKUP	
	REGULAR DEEP DISCHARGE	FREQUENT PARTIAL DISCHARGE	OCCASIONAL DEEP DISCHARGE	
	<p>EnergyCell RE 12V Top Terminal / Front Terminal EnergyCell 2V Top Terminal</p>	<p>EnergyCell NC 12V Top Terminal / Front Terminal EnergyCell 2V Top Terminal</p>	<p>EnergyCell GH 12V Front Terminal</p>	
INDOOR SYSTEMS	>130 kWh	<p>EnergyCell RE High Capacity</p>	<p>EnergyCell NC High Capacity</p>	<p>EnergyCell GT High Capacity</p>
	20-30 kWh	<p>EnergyCell RE 12V Front Terminal with IBR-3</p>	<p>EnergyCell NC 12V Front Terminal with IBR-3</p>	<p>EnergyCell GH 12V Front Terminal with IBR-3</p>
	10-20 kWh	<p>EnergyCell RE 12V Front Terminal with IBR-2</p>	<p>EnergyCell NC 12V Front Terminal with IBR-2</p>	<p>EnergyCell GH 12V Front Terminal with IBR-2</p>
	5-10 kWh	<p>EnergyCell RE 12V Top Terminal with IBE-2</p>	<p>EnergyCell NC 12V Top Terminal with IBE-2</p>	<p>EnergyCell GH 12V Front Terminal with IBR-2</p>
	<5 kWh	<p>EnergyCell RE 12V Top Terminal with IBE-1</p>	<p>EnergyCell NC 12V Top Terminal with IBE-1</p>	<p>EnergyCell GH 12V Front Terminal with IBR-2</p>
OUTDOOR SYSTEMS	>30 kWh	<p>EnergyCell RE 12V Front Terminal with OBE-3-FT</p>	<p>EnergyCell NC 12V Front Terminal with OBE-3-FT</p>	<p>EnergyCell GH 12V Front Terminal with OBE-3-FT</p>
	>20 kWh	<p>EnergyCell RE 12V Top Terminal with OBE-3</p>	<p>EnergyCell NC 12V Top Terminal with OBE-3</p>	<p>EnergyCell RE 12V Top Terminal with OBE-3</p>



EnergyCell® RE Front & Top Terminal

12V VRLA AGM Batteries for Renewable Energy Storage



Top Terminal



Front Terminal

The EnergyCell RE Valve Regulated Lead Acid (VRLA) battery is designed for high power density and renewable energy cycling applications.

Absorbed Glass Matt (AGM) technology provides for efficient gas recombination of up to 99% and freedom from electrolyte maintenance. The EnergyCell RE also features low profile terminals with threaded copper alloy inserts providing reduced maintenance and increased safety.

Product Highlights:

- Front and Top Terminal Access Design for Ease of Installation and Maintenance
- High-Density Pasted Plates
- Long Life in Cycling Applications
- UL-Recognized Component

EnergyCell RE Models:	EnergyCell 106RE (Top Terminal)	EnergyCell 200RE (Front Terminal)
Cells per Unit	6	6
Voltage per Unit	12VDC	12VDC
Operating Temperature Range (w/ temperature compensation)	Discharge: -40 to 71°C (-40 to 160°F) Charge: -23 to 60°C (-10 to 140°F)	Discharge: -40 to 71°C (-40 to 160°F) Charge: -23 to 60°C (-10 to 140°F)
Optimal Operating Temperature Range	23 to 27°C (74 to 80°F)	23 to 27°C (74 to 80°F)
Float Charging Voltage	13.5 to 13.8VDC / unit average at 25°C (77°F)	13.62VDC / unit average at 25°C (77°F)
Absorbed Voltage	14.4VDC, unit average at 25°C (77°F)	14.4VDC / unit average at 25°C (77°F)
Maximum Charge Current	30.0A	53.40A
Self Discharge	Battery can be stored up to 6 months at 25°C (77°F) before a freshening charge is required. Batteries stored at temperatures greater than 25°C (77°F) will require recharge sooner than batteries stored at lower temperatures.	
Temperature Compensation Factor (Charging)	5mV per °C per cell (2V)	5mV per °C per cell (2V)
Terminal	Copper alloy insert terminal to accept ¼"-20 UNC bolt	Threaded copper alloy insert terminal to accept ¼"-20 UNC bolt
Terminal Hardware Initial Torque	110in-lbs (12.4Nm)	110in-lbs (12.4Nm)
Weight	69 / 31.3	131 / 60
Dimensions H x D x W (in/cm)*	8.52 x 13.42 x 6.80 / 21.64 x 34.09 x 17.27	12.60 x 22.01 x 4.95 / 32.0 x 55.9 x 12.6

Discharge in Hours:	12V Ampere Hour Capacity to 1.75 Volts Per Cell at 77°F (25°C)										
	1	2	3	4	5	8	12	20	24	48	100
EnergyCell 106RE	49.2	61.5	70	76	80.6	89	94.2	100	101	102.6	106
EnergyCell 200RE	103.0	120.0	132.0	139.6	145.5	158.4	168.0	178.0	181.4	189.6	200.0

*Batteries to be installed with 0.5 in (12.7 mm) spacing minimum and free air ventilation.



EnergyCell® RE High Capacity

24/48V VRLA AGM Battery Bank

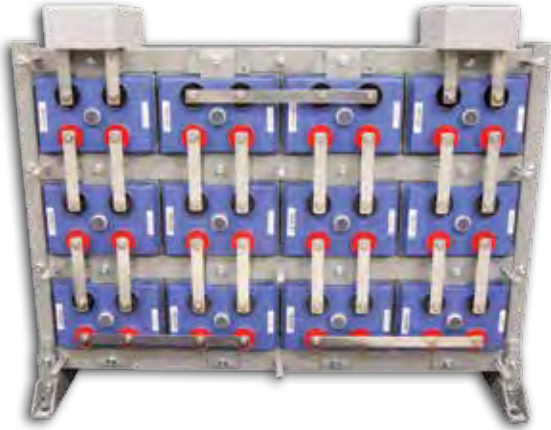

The EnergyCell RE High Capacity battery family offers an ideal solution for large capacity Valved Regulated Lead Acid (VRLA) battery requirements. The EnergyCell RE High Capacity battery's steel can (module) design concept, with its integral racking system, provides a cost effective battery system with a compact, quick and simple installation process.

The EnergyCell RE high capacity battery system's AGM technology incorporates an enhanced cell design with a superior racking system. The enhanced cell incorporates thicker positive plates for longer life. The welded/epoxy dual post seal design provides the highest integrity seal in the industry. The large copper post design also enhances the high rate performance. The EnergyCell RE high capacity battery provides excellent performance and service life in grid-tied, grid-interactive and off-grid renewable energy and UPS solutions.

Product Highlights:

- Ideal for Applications Requiring Large Capacity VRLA Batteries
- 100% Out-of-Box Initial Battery Capacity
- Low Maintenance, No Watering Required
- 24 and 48V Options Available in Standard Configurations

Models:	800RE	1100RE	1300RE	1600RE	2000RE	2200RE	2700RE
Nominal Voltage Per Cell	2V	2V	2V	2V	2V	2V	2V
Capacity 20Hr Rate (1.75VPC)	672	960	1148	1378	1716	1836	2288
Capacity 100Hr Rate (1.75VPC)	810	1150	1340	1600	2070	2140	2770
Watts Per Cell 15min Rate (1.67VPC)	1230	1757	1995	2394	3071	3192	4094
Cycle Life 50% DOD (77°F/25°C)	1800 cycles	1800 cycles	1800 cycles	1800 cycles	1800 cycles	1800 cycles	1800 cycles
Optimal Operating Temperature Range	73.4 to 78.8°F (23 to 26°C)	73.4 to 78.8°F (23 to 26°C)	73.4 to 78.8°F (23 to 26°C)	73.4 to 78.8°F (23 to 26°C)	73.4 to 78.8°F (23 to 26°C)	73.4 to 78.8°F (23 to 26°C)	73.4 to 78.8°F (23 to 26°C)
OCV Per Cell Limit*	2.05	2.05	2.05	2.05	2.05	2.05	2.05
Initial Charge Voltage Per Cell**	2.27	2.27	2.27	2.27	2.27	2.27	2.27
Float Voltage Per Cell (77°F/25°C)	2.25	2.25	2.25	2.25	2.25	2.25	2.25
Float Voltage Per Cell (95°F/35°C)	2.21	2.21	2.21	2.21	2.21	2.21	2.21
Equalize Voltage Per Cell*** (69.8 to 89.6°F/21 to 32°C)	2.32	2.32	2.32	2.32	2.32	2.32	2.32
Maximum Charge Current (A)	148.75	212.5	250	300	375	400	500
Shelf Life (77°F/25°C)	6 months	6 months	6 months	6 months	6 months	6 months	6 months
Short Circuit Current (A)	4728	6748	7722	9267	12411	12337	16548
Internal Resistance (micro Ohm)	441	309	270	225	167	169	126
Terminal Torque (Inter cell Connects)	88in-lbs	88in-lbs	88in-lbs	88in-lbs	88in-lbs	88in-lbs	88in-lbs
Hardware Specification (Inter cell Connects)	M8 bolt, lock and flat washer	M8 bolt, lock and flat washer	M8 bolt, lock and flat washer	M8 bolt, lock and flat washer	M8 bolt, lock and flat washer	M8 bolt, lock and flat washer	M8 bolt, lock and flat washer
Weight Per Cell (lbs/kg)	114.3 / 51.8	162.3 / 73.6	188.3 / 85.4	222.3 / 100.8	272.3 / 123.5	290.3 / 131.7	358.3 / 162.5
Dimensions	Please refer to the OutBack EnergyCell High Capacity specifications poster for system dimensions.						



EnergyCell® GH Front Terminal

VRLA Battery for Grid/Hybrid Storage



The EnergyCell GH Valve Regulated Lead Acid (VRLA) battery is designed for Grid/Hybrid storage applications.

EnerSys SBS EON technology incorporates TPPL AGM (Thin Plate Pure Lead Advanced Glass Mat) which allows for greater shelf life, extended float service life in optimal operating conditions, and higher energy density. The EnergyCell GH also features front terminal access with threaded copper inserts providing low maintenance and increased safety.

Product Highlights:

- Ideal for Grid/Hybrid Applications
- Front Terminal Access Design for Ease of Installation and Maintenance
- Wide Operating Temperature Range
- UL-Recognized Component

Models:	EnergyCell 200GH	EnergyCell 220GH
Cells Per Unit	6	6
Voltage Per Unit	12VDC	12VDC
Operating Temperature Range (w/ temperature compensation)	-40 to 122°F (-40 to 50°C)	-40 to 122°F (-40 to 50°C)
Optimal Operating Temperature Range	68°F (20°C)	68°F (20°C)
Float Charging Voltage	13.62VDC / unit average at 77°F (25°C)	13.62VDC / unit average at 77°F (25°C)
Maximum Charge Current	106.2A	118.8A
Absorbed Voltage	14.4VDC / unit average at 77°F (25°C)	14.4VDC / unit average at 77°F (25°C)
Self Discharge	Battery can be stored up to 18 months at 77°F (25°C) before a freshening charge is required. Batteries stored at temperatures greater than 77°F (25°C) will require recharge sooner than batteries stored at lower temperatures.	
Temp Compensation Factor (Charging)	±4mV per °C per cell (2V)	±4mV per °C per cell (2V)
Terminal	Threaded copper alloy insert terminal to accept ¼"-20 UNC bolt	Threaded copper alloy insert terminal to accept ¼"-20 UNC bolt
Terminal Hardware Initial Torque	M6 = 80in-lbs (9.0Nm)	M6 = 80in-lbs (9.0Nm)
Weight (lb/kg)	116 / 53	132 / 60
Dimensions H x D x W (in/cm)	11.1 x 22.1 x 4.9 / 28.2 x 56.1 x 12.4	12.4 x 22.1 x 4.9 / 31.5 x 56.1 x 12.4

Discharge in Hours:	12V Ampere Hour Capacity to 1.75 Volts Per Cell at 77°F (25°C)								
	1	3	4	5	8	12	20	24	100
EnergyCell 200GH	120	148.5	154.8	159	168.8	176.4	191	189.6	200
EnergyCell 220GH	133.5	166.2	173.2	178	188.8	198	214	216	220



EnergyCell® NC Front & Top Terminal

Nano-Carbon, Partial State of Charge (PSoC) Batteries



Top Terminal



Front Terminal

With limited sun hours for proper recharging of standard deep cycle batteries, the need for a PSoC technology is great. This advanced technology will allow for extended life of a battery in self-consumption applications.

Nano-Carbon offers all the safety and convenience of a VRLA battery with the cycling benefits of advanced energy storage. Operation of Nano-Carbon in an application where full battery recharges aren't always possible, like off-grid or areas of the world with limited sun hours, can maximize your overall cycle life by up to 44% versus a traditional VRLA deep cycle battery.

The Nano-Carbon is an enhanced and optimized negative active material formulation which makes it more than just a carbon additive. The high surface area carbon is a specially formulated additive for improving the negative active material in lead-acid batteries. Carbon increases conductivity and adds additional capacitance to the battery. Nano-Carbon improves charge efficiency and allows PSoC operation with improved deep discharge recovery.

Product Highlights:

- For Energy Arbitrage and Self-Consumption Applications
- Safe, Maintenance-Free Convenience
- Up to 44% Improved Cycle Life vs Traditional VRLA Batteries
- Up to 95% Round-Trip Efficiency

Models:	EnergyCell 106NC (Top Terminal)	EnergyCell 200NC (Front Terminal)
Cells per Unit	6	6
Voltage per Unit	12VDC	12VDC
Operating Temperature Range (w/ Temperature Compensation)	Discharge: -40 to 71°C (-40 to 160°F) Charge: -23 to 60°C (-10 to 140°F)	Discharge: -40 to 71°C (-40 to 160°F) Charge: -23 to 60°C (-10 to 140°F)
Optimal Operating Temperature Range	23 to 27°C (74 to 80°F)	23 to 27°C (74 to 80°F)
Recommended Maximum Charging Current Limit per String	30ADC	53ADC
Float Charging Voltage	13.62VDC unit average at 25°C (77°F)	13.62VDC / unit average at 25°C (77°F)
Equalization and Cycle Service Charging Limits	14.4VDC unit average at 25°C (77°F)	14.4VDC / unit average at 25°C (77°F)
Self Discharge	Battery can be stored up to 6 months at 25°C (77°F) before a freshening charge is required. Batteries stored at temperatures greater than 25°C (77°F) will require recharge sooner than batteries stored at lower temperatures.	
Temperature Compensation Factor (Charging)	5mV per °C per cell (2V)	5mV per °C per cell (2V)
Terminal	Threaded copper alloy insert terminal to accept ¼"-20 UNC bolt	Threaded copper alloy insert terminal to accept ¼"-20 UNC bolt
Terminal Hardware Initial Torque	110in-lbs (12.4Nm)	110in-lbs (12.4Nm)
Weight (lb/kg)	69 / 31	131 / 60
Dimensions H x D x W (in/cm)*	8.52 x 13.42 x 6.80 / 216.4 x 340.9 x 172.7	12.60 x 22.01 x 4.95 / 32.0 x 55.09 x 12.6

12V Ampere Hour Capacity to 1.75 Volts Per Cell at 77°F (25°C)

Discharge in Hours:	1	2	3	4	5	8	12	20	24	48	100
EnergyCell 106NC	49.2	61.5	70	76	80.6	89	94.2	100	101	102.6	106
EnergyCell 200NC	103	120	132	139.6	145.5	158.4	168	178	181.4	189.6	200



EnergyCell[®] NC High Capacity

48V Partial State of Charge (PSoC) Energy Storage Technology



The EnergyCell Nano-Carbon High Capacity battery line provides an ideal solution for larger applications where limited sun hours are available for proper recharging of standard deep cycle batteries.

The Nano-Carbon is an enhanced and optimized negative active material formulation which makes it more than just a carbon additive. The high surface area carbon is a specially formulated additive for improving the negative active material in lead-acid batteries. Carbon increases conductivity and adds additional capacitance to the battery. Nano-Carbon improves charge efficiency and allows PSoC operation with improved deep discharge recovery.

The included pre-assembled steel racking system allows for ease of installation with a small footprint and front access to all cell connections.

Product Highlights:

- Ideal for Large Residential and Commercial Self-Consumption Applications
- Up to 44% Improved Cycle Life vs Traditional VRLA Batteries
- Up to 95% Round-Trip Efficiency
- 3-Year Full Replacement Warranty

Models:	EnergyCell 1100NC	EnergyCell 1600NC	EnergyCell 2000NC	EnergyCell 2200NC
Technology	VRLA-AGM Carbon	VRLA-AGM Carbon	VRLA-AGM Carbon	VRLA-AGM Carbon
Cell Voltage	2V	2V	2V	2V
48V Cell Configuration	4x6	4x6	4x6	4x6
Cycle Life (50% DOD 1.75VPC)	2000	2000	2000	2000
Ah Capacity	C/24 1.75VPC: 926 C/100 1.75VPC: 1060	C/24 1.75VPC: 1392 C/100 1.75VPC: 1600	C/24 1.75VPC: 1740 C/100 1.75VPC: 1990	C/24 1.75VPC: 1855 C/100 1.75VPC: 2130
Short Circuit Current (A)	4240	6359	7949	8479
Maximum Charge Current (A)	397	595	744	794
Internal Resistance (mOhm)	0.4718	0.3145	0.2516	0.2359
Storage per Cell (kWh)	C/24: 1.85 C/100: 2.12	C/24: 2.78 C/100: 3.20	C/24: 3.48 C/100: 3.98	C/24: 3.71 C/100: 4.26
Dimensions L x W x H (in/mm)	26.38 x 28.25 x 45.78 / 670 x 718 x 1163	26.38 x 28.25 x 63.78 / 670 x 718 x 1620	26.38 x 28.25 x 77.28 / 670 x 718 x 1963	26.38 x 28.25 x 81.78 / 670 x 718 x 2077
Weight (lb/kg)	3220 / 1461	4420 / 2205	5365 / 2434	5740 / 2604
Operating Temperature Range (°F/°C)	-40 to 140 / -40 to 60	-40 to 140 / -40 to 60	-40 to 140 / -40 to 60	-40 to 140 / -40 to 60
Shelf Life (@ 25 °C)	12 months	12 months	12 months	12 months
Warranty	3 years	3 years	3 years	3 years

48V Ampere Hour Capacity to 1.75 Volts Per Cell at 77°F (25°C)

Discharge in Hours:	1	2	3	4	8	10	12	20	24	48	100
EnergyCell 1100NC	391.1	543.0	621.0	674.0	794.4	829.0	854.4	918.0	926.4	998.4	1060.0
EnergyCell 1600NC	586.7	814.6	931.8	1011.6	1191.2	1243.0	1282.8	1376.0	1392.0	1497.6	1600.0
EnergyCell 2000NC	733.4	1018.2	1164.6	1264.4	1489.6	1554.0	1603.2	1720.0	1740.0	1872.0	1990.0
EnergyCell 2200NC	782.3	1086.2	1242.3	1348.8	1588.8	1658.0	1710.0	1834.0	1855.2	1996.8	2130.0

* Batteries to be installed with 0.5 in (12.7 mm) spacing minimum and free air ventilation.



EnergyCell® OPzV

VRLA Tubular Gel Energy Storage Batteries



EnergyCell OPzV is an energy storage battery developed for applications requiring regular deep cycling.

Maintenance-free energy storage solution that offers significant benefits in terms of cost per cycle, combined with the highest level of reliability and performance even for remote installations where long discharges occur and excellent recharging properties are essential. Optimum design, exclusive use of high quality materials, robust construction and state-of-the-art manufacturing processes make EnergyCell OPzV batteries an ideal solution for demanding renewable energy storage applications.

Product Highlights:

- Maintenance-Free Design
- Hardware and Intercell Connects Included
- 3,000 cycles @ 50% DOD
- Optional 24V + 48V Racks and Breaker Disconnects Available
- 3 Year Full Replacement Warranty

Models:	OPzV-450	OPzV-750	OPzV-2000	OPzV-3000
Technology	OPzV VRLA Tubular GEL	OPzV VRLA Tubular GEL	OPzV VRLA Tubular GEL	OPzV VRLA Tubular GEL
Cell Voltage	2V	2V	2V	2V
Cycle Life (50% DOD 1.75VPC)	3000	3000	3000	3000
Short Circuit Current	3380A	4520A	8640A	12680A
Maximum Charge Current(A)	3*I10 = 100.8 (20°C)	3*I10 = 170 (20°C)	3*I10 = 414 (20°C)	3*I10 = 648 (20°C)
Internal Resistance (mOhm)	0.60	0.45	0.24	0.16
Storage Per Cell (kWh)	C/24: 0.77 C/120: 0.87	C/24: 1.3 C/120: 1.4	C/24: 3.24 C/120: 3.75	C/24: 5.0 C/120: 5.65
Dimensions L x W x H (mm/in)	145 x 206 x 382 / 5.71 x 8.11 x 15.04	166 x 206 x 498 / 6.54 x 8.11 x 19.61	275 x 210 x 673 / 10.82 x 8.27 x 26.5	399 x 214 x 799 / 15.71 x 8.43 x 31.46
Weight (kg/lb)	28.0 / 61.71	42.0 / 92.57	97.0 / 213.8	165.0 / 363.8
Operating Temperature Limits (°C)	-20 to 45 (preferably ACC to manual)	-20 to 45 (preferably ACC to manual)	-20 to 45 (preferably ACC to manual)	-20 to 45 (preferably ACC to manual)
Shelf Life (@ 20°C)	6 months	6 months	6 months	6 months
Warranty	3 years	3 years	3 years	3 years

48V Ampere Hour Capacity to 1.75 Volts Per Cell at 68°F (20°C)

Discharge in Hours:	8	10	12	20	24	48	72	100	120	240
EnergyCell OPzV-450	334.24	348.4	359.76	389.8	399.84	434.4	451.44	463.0	468.0	482.4
EnergyCell OPzV-750	567.4	592.9	613.2	667.4	685.7	749.3	780.5	802.0	813.6	844.8
EnergyCell OPzV-2000	1387.0	1449.5	1499.0	1632.2	1677.8	1840.3	1925.3	1987.0	2017.2	2100.0
EnergyCell OPzV-3000	2171.0	2264.0	2337.2	2529.4	2593.4	2813.4	2923.9	3001.0	3038.4	3141.6



Integrated Battery Rack

Indoor Energy Storage Solutions



IBR-2



IBR-3

The OutBack Integrated Battery Racks are a comprehensive battery enclosure solution with cell interconnects, cabling, and series string overcurrent protection and disconnects included, making it easy to order and install. All electrical connections are made at the factory and ship fully assembled with the exception of the batteries, which can be quickly added and connected on the job site.

Unlike typical steel racks, the OutBack design is crafted of powder-coated aluminum, resulting in a rack that maintains a clean, durable appearance even in challenging environments while weighing less than 90 pounds. The IBR-2 is sized to fit under an OutBack Radian Series inverter/charger to reduce system component “clutter” and make the best use of installation space.

Product Highlights:

- Ideal for Use With OutBack Radian and FLEXpower Systems
- Overcurrent Protection on Each Battery String
- Well-Ventilated for Safety and Longevity
- Pre-Wired for Ease of Installation
- Designed to Meet UL1741

Models:	IBR-2-48-175	IBR-3-48-175
Dimensions H x W x D (in/cm)	33 x 27 x 24.5 / 83.8 x 68.6 x 62.2	48.6 x 27 x 24.5 / 123.4 x 68.6 x 62.2
Weight w/out Batteries (lb/kg)	60 / 27	89 / 40.4
Physical Characteristics	0.125in thick aluminum enclosure with FLEXware silver finish; plated copper bus bars and clear protective covers. Ships fully assembled (except for batteries)	
String Overcurrent Protection	175ADC	175ADC
Gauge of Conductors	1/0 AWG	1/0 AWG
Capacity	Up to 8 EnergyCell batteries	Up to 12 EnergyCell batteries
Nominal System Voltage	48VDC	48VDC
Supported Batteries	EnergyCell 200RE, EnergyCell 170RE, EnergyCell 200GH, EnergyCell 220GH, EnergyCell 200NC and EnergyCell 170NC	



Indoor Battery Enclosure

Indoor Energy Storage



IBE-1

IBE-2

The standard series IBE enclosure family from OutBack Power is engineered for use with maintenance-free, top terminal EnergyCell batteries and is ideally suited for value-oriented applications requiring up to 212Ah of energy storage.

The IBE series features welded, all aluminum construction and powder-coated finish for strength and durability. Removable, lockable doors keep batteries and wiring secure and protected. A mesh screen allows for ventilation of the enclosure, helping to keep batteries cool. The IBE series also ships pre-assembled with battery wiring kits included for ease of installation.

Product Highlights:

- Aluminum Welded Construction and Powder-coated Exterior
- Ideal for Value-Oriented Applications Up to 212Ah of Storage
- Optimized for Use with EnergyCell RE Top Terminal Batteries
- No Assembly Required, Battery Cable Kit Included
- CSA/UL Certified to Meet Applicable Industry Standards

Models:	IBE-1	IBE-2
Dimensions H x W x D (in/cm)	33.5 x 26 x 15 / 85.1 x 66.0 x 38.1	48 x 26 x 15 / 121.9 x 66.0 x 38.1
Weight w/out Batteries (lb/kg)	61 / 28	75 / 34
Material	Exterior powder-coated aluminum	Exterior powder-coated aluminum
Vent Screen	Mesh fabric with .005 x .005in (.12 x .12mm) opening size to minimize snow, water and dust ingress	Mesh fabric with .005 x .005in (.12 x .12mm) opening size to minimize snow, water and dust ingress
Door and Lid Seal	Poron gasketing	Poron gasketing
Color	Gray (custom colors available)	Gray (custom colors available)
Lid	Removable	Removable
Door	Removable/lockable	Removable/lockable
Part Number	IBE-1-48-001	IBE-2-48-001



Outdoor Battery Enclosure

Outdoor Energy Storage



OutBack Power’s Outdoor Battery Enclosure (OBE) is engineered to provide end users and installers with a professional, factory pre-wired, rugged, easy-to-install NEMA 3R rated solution for “outside-the-home” energy storage.

The OBE series is designed for seamless integration with OutBack’s EnergyCell RE Top Terminal batteries, capable of holding up to 12 EnergyCell 106RE batteries (three strings, four batteries per string). The OBE series ships pre-assembled, eliminating the need for time consuming onsite assembly.

Product Highlights:

- Up to 318Ah or 15.3kWh of Storage
- NEMA 3R Rating
- No Assembly Required—Ships Pre-Assembled
- Standard Security Locks Restrict Access
- Battery Cable Kit Included

Model: OBE-3

Dimensions H x W x D (in/mm)	46.8 x 41.5 x 17 / 1188.7 x 1054.1 x 431.8
Weight w/out Batteries (lb/kg)	135 / 62
Breakers	4ea, 175ADC (1 master + 3 individual strings)
Material	Exterior powder-coated aluminum
Vent Screen	Mesh fabric with .005 x .005 (.12 x .12mm) opening size to minimize snow, water and dust ingress
Door and Lid Seal	Poron gasketing
Color	Gray (custom colors available)
Lid	Removable
Door	Removable/lockable
Part Number	OBE-3-48-002
Included Components	Enclosure, battery cable kit, flex intercell connects, concrete sleeve anchors, user’s manual, wiring diagram



OBE-3-FT

Outdoor Battery Enclosure for 48V Configurations



OutBack Power’s Outdoor Battery Enclosure for front terminal batteries (OBE-3-FT) is engineered to provide end users and installers with a professional, factory pre-wired, rugged, easy-to-install NEMA 3R rated solution for “outside-the-home” energy storage.

The OBE-3-FT series is designed for seamless integration with OutBack’s EnergyCell Front Terminal batteries, capable of holding up to 12 EnergyCell 170RE or 200GH batteries (three strings, four batteries per string). The OBE-3-FT series features welded, all aluminum construction and powder coated finish for strength and durability. Removable, lockable doors keep batteries and wiring secure and protected. A mesh screen allows for ventilation of the enclosure, helping to keep batteries cool. An externally mounted breaker disconnect panel offers easy access to breakers. The OBE-3-FT series ships pre-assembled, eliminating the need for time consuming on-site assembly.

Product Highlights:

- Up to 600Ah or 28.8kW of Storage
- NEMA 3R Rating
- Breaker Disconnects (Each String + Master Disconnect)
- For Use with PV Inverters Rated up to 8kW
- No Assembly Required—Ships Pre-Assembled
- Access Restricting, Padlockable (Locks are Standard)

Model: OBE-3-FT	
Dimensions H x W x D (in/mm)	51 x 30 x 34.6/1295 x 762 x 879
Weight w/out Batteries (lb/kg)	308 / 140
Material	Exterior powder-coated aluminum
Vent Screen	Mesh fabric to minimize snow and dust ingress
Door and Lid Seal	Poron gasketing
Color	Almond
Door	Removable/lockable
Manufacturing Part Number	OBE-3-48-002-FT
Included Components	Enclosure, battery cable kit, user’s manual, wiring diagram



FLEXcoupled Solution

Adding Energy Storage to Existing Radian Inverter/Charger



**Integrated Battery Rack
w/ EnergyCell GH Batteries**



**Radian Series Inverter/Charger
w/ GS Load Center**



**Integrated Battery Rack
w/ EnergyCell RE Batteries**

Typical grid-tied PV systems save money by selling back to the utility when the sun is up, but they do not provide back-up power when the grid goes down. There's an easy affordable way to maximize the value of an existing grid-tied only system. Upgrade to a battery-based grid-interactive system with a FLEXcoupled solution from OutBack power and enjoy both grid-tied savings and off-grid energy independence. The FLEXcoupled AC-coupling solution enables an existing grid-tied inverter system to "couple" with a second battery-based grid-interactive inverter and share their combined energy while providing back-up power, security and flexibility.

Package #1: 8000W FLEXcoupled Radian Series Solution (P/N: FPR-AC-8048A, ideal for an existing PV system from 3-6kW)

Product/Model	Description	Quantity
Radian GS8048A	8000W, 48V 120/240V Radian Series inverter/charger	1
GSLC175-AC-120/240	AC-coupling GS load center	1
MATE3	Advanced system display and communications	1
FW-MB3	MATE3 mounting bracket	1
FW-CABLE250-36R	Red DC cable assemblies	1
FW-CABLE250-36W	White DC cable assemblies	1

Package #2: 4000W FLEXcoupled Radian Series Solution (P/N: FPR-AC-4048A, ideal for an existing 3kW PV system)

Product/Model	Description	Quantity
Radian GS4048A	4000W, 48V 120/240V Radian Series inverter/charger	1
GSLC175-AC-120/240	AC-coupling GS load center	1
MATE3	Advanced system display and communications	1
FW-MB3	MATE3 mounting bracket	1
FW-CABLE250-36R	Red DC cable assemblies	1
FW-CABLE250-36W	White DC cable assemblies	1

FLEXnet DC

State of Charge

Monitoring if Charge Parameters Allow

HUB

Monitoring if Less Than 50%

OutBack POWER
www.outbackpower.com

SN: FNDC10112

FLEXnet DC

BAT1	RELAY	C DEVICE SOC	B DEVICE SOC	A DEVICE SOC
BAT2	RELAY	C BAT1 SOC	B BAT1 SOC	A BAT1 SOC



BATTERY

INVERTER

CHARGER

BEN

GTFX3048

Single Phase Utility Interactive
SineWave Inverter/Charger
with AC Transfer Switch

Serial Number

OutBack POWER
www.outbackpower.com



MANAGE THE SYSTEM

System Monitoring and Control

OPTICS RE.....	56
OutBack Management Product Introduction	57

System Display and Communications

MATE3	58
MATE	59
MATE2	59

Modbus/TCP Interface

AXS Port	60
----------------	----

System Communications Manager

HUB4	61
HUB10.3	61

DC System Monitoring

FLEXnet DC.....	62
-----------------	----



OPTICS RE

WEB-ENABLED MONITORING AND CONTROL PLATFORM

It's a powerful advantage...the ability to see the electricity you produce and consume. To **monitor and control your renewable energy system with the touch of a button from any internet connected device**—anywhere in the world. Real-time status and hands-on control of your power flow and energy storage. Track individual system performance or manage a network of dispersed systems.



OutBack OPTICS RE Features



See your energy use and production



Simple insight into complex data via historical graphs



Access your system from any internet connected device



Notifications and alerts sent via email



Remote control access of your system



Protect your solar energy investment



Easily verify system performance and health



Save up to 30% on energy bills



Smart grid ready



Stay connected with your green lifestyle

OutBack Management Products

OutBack Power's proprietary communication network enables all of our products to communicate with each other, providing a seamless setup and user experience across all components of an OutBack system. OutBack's communications product line currently includes a variety of communication devices for maximum flexibility and control of your renewable energy system.

SYSTEM DISPLAY AND COMMUNICATIONS

The MATE system display and controller series makes it easier than ever to program and monitor a complete OutBack Power system. Intuitive user interfaces and integrated system configuration wizard make system setup and programming quick and seamless.

- MATE3
- MATE/MATE2

MODBUS/TCP INTERFACE

The AXS Port Modbus TCP interface is a powerful and economical tool that allows installers and system owners the ability to monitor and control system status from any location. When paired with OPTICS RE, the AXS Port interface offers a host of advanced monitoring and control features.

SYSTEM COMMUNICATIONS MANAGER

The HUB system communications manager series is the backbone of your networked OutBack power conversion system. The OutBack HUB communicates stacking, load share and power save on/off signals. Through the use of a HUB, your system is completely coordinated and managed by a MATE or MATE3.

- HUB4
- HUB10.3

DC SYSTEM MONITORING

FLEXnet DC is the ultimate DC system monitoring device. Our integrated networked communications make valuable, usable data available and viewable on an OutBack MATE communications device, providing you with the critical answers about your system's health, performance and efficiency.



"OutBack Power products are perfect for Louisiana's high-humidity, hostile climate because they continue working under tough conditions."

—Jeff Shaw, Gulf South Solar



"With the MATE3, we can set parameters and use OPTICS RE to monitor the system and troubleshoot remotely, without sending a truck out. Based on my experience with OutBack, I see no reason to ever use another vendor."

—Joel Teslow, Decorah Electric

Make the Power, Store the Energy, Manage the System.



OutBack's communication hardware provides owners with streamlined system management. When paired with OPTICS RE—OutBack's web-enabled monitoring and control platform—owners have total control over how their system utilizes and stores harvested renewable energy.



MATE3

Advanced System Display and Communications

OPTIMIZE WITH



OPTICS^{RE}



The MATE3 advanced system display and communications make it easier than ever to program and monitor a complete OutBack Power system. An intuitive user interface and integrated system configuration wizard make system setup and programming quick and seamless. The ability to set unique multi-level user passwords makes it possible to secure critical system settings from unintended changes while still allowing open access to necessary functions.

Other features making system management simpler include an easy-to-read graphical backlit LCD display, improved tactile buttons, and user programmable "favorite" keys for immediate access to the most wanted features. An intuitive scroll wheel interface allows easy adjustment of system set points. Expandable SD card memory increases data-logging capacity as well as making it easy to upgrade units in the field.

A built-in clock and calendar function enables timer-based programming of inverter and charger operation. This setting allows the system to work with time-of-day power rates or to limit a generator's runtime to a specific time period of the day or week. All settings are stored in onboard memory to eliminate the need to reprogram in the event of a system shutdown or battery replacement. The MATE3 supports web-server access via an intranet to allow monitoring of an OutBack system.

Product Highlights:

- Program, Manage and Monitor Entire System
- Intuitive Menu Structure with Easy-to-Read Graphical Display
- System Configuration Wizard
- Up to One Year of Data Logging

Model:	MATE3
Display	4.0 x 1.2" full graphical display
Quick System Access	5 system operation hot keys, 4 user programmable soft keys
Status Indicators	(9) LED indicators
Navigational Controls	5 navigational keys
Setpoint Adjustment	Touch sensitive scroll wheel
Communication Protocol	Proprietary OutBack communications protocol
Interconnect Cabling Included	Standard CAT5 network cable with RJ-45 modular jack - 6' (2m) included
PC Computer Interface	HTML system status dashboard over local intranet connection
Field Update Capability	Yes (includes Radian Series inverter/chargers, FLEXmax Series charge controllers [rev 3.0 or higher] and FLEXmax Extreme charge controller)
Microprocessor	80MHz 32 bit processor
Set Point and Data Memory	8Mb RAM/ 64Mb of flash RAM
Clock/Calendar	On-board real time clock with battery backup
Operating Temperature Range	0 to 50°C
Mounting	Surface-mount (various brackets available)
Environmental Rating	Indoor Type 1 (IP 30)
Maximum Cable Length	300' (100m)
Optional Accessories	MATE3 USB card
Warranty	Standard 5 year Warranty
Weight (lb/kg)	Unit: 1.4 / 0.64 Shipping: 3.0 / 1.36
Dimensions H x W x D (in/cm)	Unit: 7.1 x 7.5 x 1.6 / 18 x 19 x 4.1 Shipping: 3.25 x 9 x 13.5 / 8.26 x 22.9 x 34.3



MATE & MATE2

System Display and Communications



MATE



MATE2

The MATE system display and communication devices are complete management tools for your OutBack Power system. Through the use of a single MATE or MATE2, you can remotely manage and monitor multiple inverter/chargers, FLEXmax charge controllers and any future OutBack Power conversion or control product.

The MATE and MATE2 are packed full of features to make system management simple. The easy-to-read 3.1" (8 cm) LCD is backlit for dark operating conditions. Four soft keys allow easy context-based navigation of menus and functions. Two hot keys give immediate access to AC and inverter functions.

A built-in clock and calendar function enables timer based programming of inverter and charger operation, allowing operators to set the system to work with time-of-day power rates or to limit a generator's runtime to a specific time period of the day or week. All of your settings are stored in permanent memory to eliminate the need to reprogram in the event of a system shutdown or battery replacement. The MATE and MATE2 include a RS232 port with DB9 jack for connection to the serial port of a PC computer. Through the use of optional WinVerter software, operators can perform actions such as data-logging and graphical display of the system's operation and performance. The MATE system display and controller is surface mounted while the MATE2 is flush mountable in a wall cut-out.

Product Highlights:

- Simple System Management
- Four Soft Keys Allow Easy Context-Based Navigation of Menus and Functions
- Built-In Clock and Calendar Function
- Two Hot Keys Give Immediate Access to AC and Inverter Functions

Models: MATE & MATE2

Product Color/Mount	MATE: Gray or black, surface-mount MATE2: Black, flush-mount
Interface Display	3.1" (8 cm) backlit LCD including 2 four line, 80 alpha numeric characters
Control Keypad	6 backlit silicone keys, dedicated inverter and AC input keys
Status Indicators	Two LED Status Indicators: AC input (yellow), inverting (green)
Communication Protocol	Proprietary OutBack multi-drop using an OutBack HUB4 or HUB10
Interconnection Cabling	Standard CAT5 network cable with RJ-45 modular jack, 10' (5m) included
PC Computer Interface	RS232 opto-isolated DB9 jack 9600 baud serial communication
Microprocessor	16MHz low power consumption
Set Point and Data Memory	32k non-volatile flash RAM
Clock/Calendar	On-board real time clock with battery backup
Operating Temperature Range	0 to 50°C
Environmental Rating	Indoor Type 1 (IP 30)
Maximum Cable Length	1000' (300m)
Warranty	Standard 5 year
Shipping Weight (lb/kg)	1 / 0.5
Shipping Dimensions H x W x L (in/cm)	4.25 x 5.75 x 2 / 11 x 15 x 5



AXS Port

Modbus Transmission Control Protocol (TCP) Interface

OPTIMIZE WITH



OPTICS^{RE}



The AXS Port Modbus TCP, now OPTICS RE compatible, is a powerful and economical tool that allows installers and system owners the ability to monitor and control system status from any location. When paired with OPTICS RE, the AXS Port interface offers advanced system monitoring and control features including:

- Real-Time PV/Solar System Performance Monitoring via Intuitive Dashboard Interface from any Internet-Connected Device
- Efficient Management of Multiple OutBack Power System Installations Under One Account
- Remote Troubleshooting
- Reduced Onsite Service Calls and System Downtime

The AXS Port makes it possible to create custom user interfaces for systems using the advanced API program development kit* and download system data logs using Modbus-read or FTP transfer. All user-configurable values are backed up with non-volatile memory, ensuring stable performance and system recovery. An optional remote temperature-sensing function provides a simple, low-cost tool for capturing and reporting ambient temperature or other critical thermal information records.

The AXS Port is a SunSpec compliant device**, which means it speaks the renewable energy industry's common language used to drive data and interoperability standards for plug-and-play operation between components and management systems.

Product Highlights:

- Remote System Control and Monitoring via Web Interface with OPTICS RE
- SunSpec-Compliant Device for Interoperability and Plug-and-Play Operation
- Over Two Years of Data Logging
- Firmware Upgradable Over an Ethernet Network
- Accessories Include MicroSD Memory and DIN-Rail Mounting Clip

Model:	AXS Port
Power	Supplied by OutBack device
Status Indicators	Seven LED indicators
Clock	On-board real-time clock with battery backup
Internet Standards	TCP/IP, DNS, SMTP, FTP, DHCP, NTP
Ports	HUB10.3/Device: RJ-45 Communications: RJ-45 Temperature Sensor: RJ-11
Communication Protocol	Modbus TCP to the SunSpec standard
OutBack Device Interface	OutBack proprietary
PC Interface	10/100 Ethernet
Mounting	DIN clip (provided) or surface mounting
Environmental Rating	Indoor Type 1 (IP 30) non-condensing
Temperature Ranges	AXS Port: -40 to 75°C SD Card: -25 to 75°C
Weight (lb/kg)	Unit: 0.5 / 0.23 Shipping: 2.1 / 0.95
Dimensions H x W x D (in/cm)	Unit: 1.29 x 3.5 x 4.99 / 3.3 x 8.9 x 12.7 Shipping: 3.25 x 9 x 13.5 / 8.3 x 22.9 x 34.3
SD Card Size	MicroSD Type 2 (2 GB capacity)
Options	OutBack RTS
Certifications	FCC Part 15, subpart B CE, RoHS, SunSpec



HUB4 & HUB10.3

System Communications Manager

HUB System Communications Manager

The HUB system communications manager components form the backbone of a networked OutBack power conversion system. The OutBack HUB communicates stacking, load share and power save off/on signals. Interconnection cabling is standard Ethernet CAT5 with RJ-45 modular jacks. Through a HUB, a system is completely coordinated and managed by the MATE advanced system display and communications.

Models:	HUB4	HUB10.3
Number of Ports	4 plus MATE	10 plus MATE
Operating Temperature Range	0 to 50°C	0 to 50°C
Three-phase/Sub-Phase Master Stacking	No	Yes
Warranty	Standard 5 year	Standard 5 year
Weight (lb/kg)	Unit: 1 / 0.5 Shipping: 3 / 1.4	Unit: 1 / 0.5 Shipping: 3 / 1.4
Dimensions H x W x L (in/cm)	Unit: 10.5 x 6.25 x 1.27 / 27 x 16 x 3 Shipping: 12 x 6 x 5 / 31 x 15 x 13	Unit: 10.5 x 6.25 x 1.27 / 27 x 16 x 3 Shipping: 12 x 6 x 5 / 31 x 15 x 13

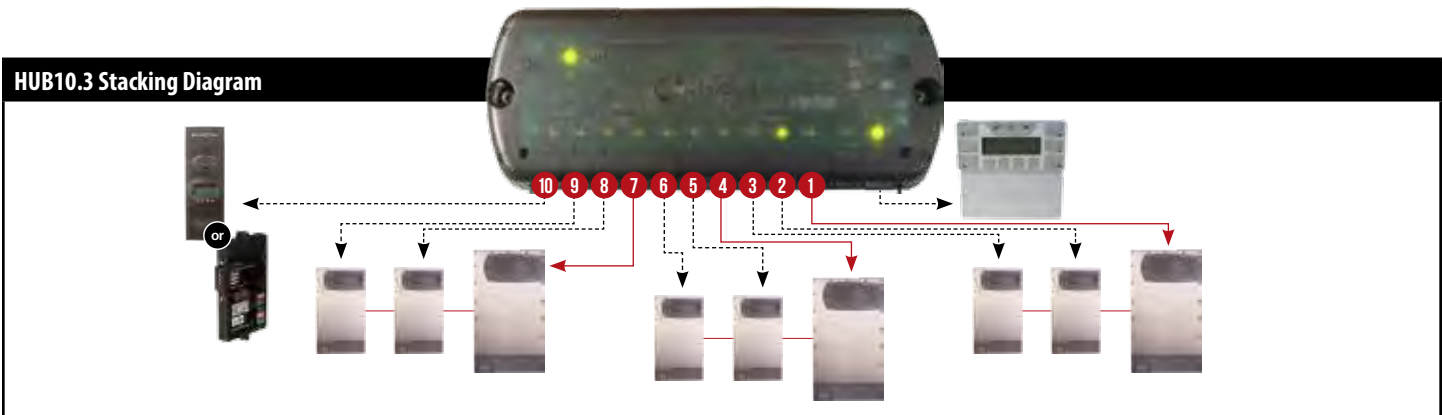
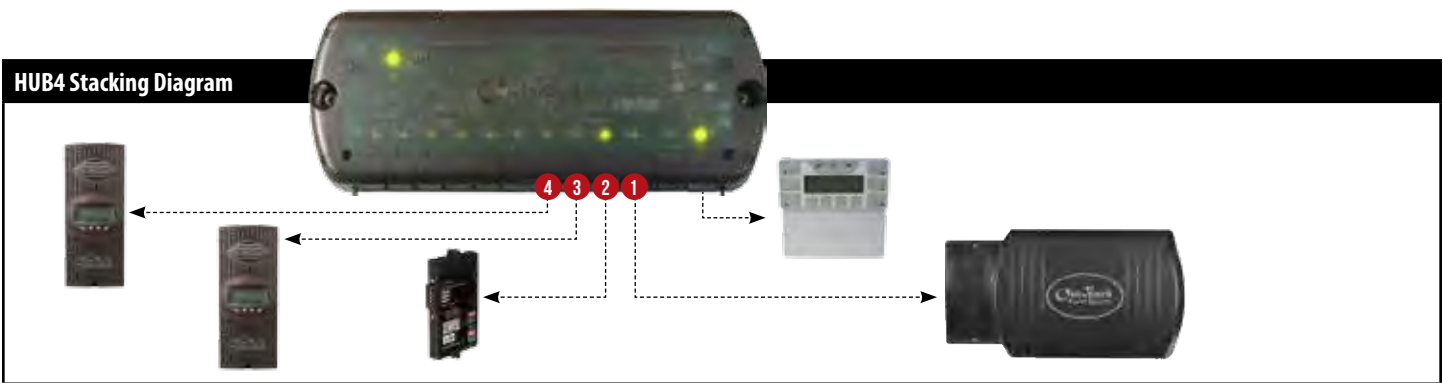



FLEXnet™ DC

Battery Monitoring Device

OPTIMIZE WITH



OPTICS_{RE}



OutBack Power's FLEXnet DC® battery monitor provides valuable system data needed to assess battery health, performance and efficiency that's easily viewable with any OutBack MATE communications device.

Battery Status Screen: Quickly view the current condition of the system's battery bank with this at-a-glance display. This screen shows the current state-of-charge and whether the battery bank is charging or discharging.

Now Summary Screen: This screen displays the amount of energy currently going in and out of the battery bank, battery bank voltage and current state-of-charge, providing real-time monitoring of production of DC sources, such as a solar array or small wind turbine, as well as consumption by loads.

Today Summary Screen: Monitor the daily amount of energy used toward charging the batteries as well as the daily lowest state-of-charge. This screen also displays cumulative energy production and consumption, providing an overall comparison of system production versus consumption.

History Summary Screen: Review historical energy production and consumption data for the most recent 128 days, including the minimum battery state-of-charge reached for each day, to monitor trends in system performance and increase efficiency.

Product Highlights:

- Monitor Energy Production and Consumption to Improve System Performance and Efficiency
- Monitor Battery Health to Extend Battery Life
- Reduces Generator Runtime and Fuel Consumption
- LED Status Lights Indicate Battery State-of-Charge Level
- Provides 128 Days of Data Logging
- Simple Installation and Setup

Model: FLEXnet DC

Battery Voltage	Input range: 8.0 to 80.0VDC Resolution: 0.1VDC
Number of Current Channels	One to three (each can be a source or load)
Current	Range (each channel): -1000.0 +1000.0ADC Resolution: 0.1ADC
State of Charge Display	0 to 100% (1% increments)
Aux Relay Configuration	SPST, magnetic latching relay
Aux Relay Maximum Rating	5A @ 30VDC
Current Shunt Type (Order Separately)	500A / 50mV
Display	Primary: MATE, MATE2 or MATE3 Secondary: Five LED Indicators on front of FLEXnet DC
Battery Ah Capacity Range	100 to 10,000Ah
Data Logging Memory	Most recent 128 days
Programmable AUX Relay Settings	Battery Volts: Adjustable from 8.0 to 80.0VDC State of Charge: Adjustable from 0 to 100% Time Delay: Adjustable from 0 to 240 Minutes
Accuracy	0.5% of reading +/- 2 LSDs per channel
Operating Temperature Range	0 to 50°C (32 to 122°F)
Mounting	3/4" Panel mount breaker slot or surface mount using built-in mounting bars
Warranty	Standard 5 year
Weight (lb/kg)	Unit: 0.31 / 0.14 Shipping: 2 / .91
Dimensions H x W x L (in/cm)	Unit: 0.7 x 3.7 x 5.5 / 1.8 x 9.4 x 14 Shipping: 2.1 x 9.0 x 11.5 / 5.3 x 22.9 x 29.2
Additional Data Available	Total battery amps, averaged battery amps, averaged battery volts, DC amp-hours IN per shunt, DC amp-hours OUT per shunt, DC kilowatt-hours IN per shunt, DC kilowatt-hours OUT per shunt, last cycle amp-hours, last cycle watt hours, last cycle amp-hour charge factor, last cycle watt hour, charge efficiency, total number of days full, cumulative battery amp-hours removed



OutBack Power Case Studies

Featuring OutBack Products Responsible for Managing the System



“Our mission was to build an efficient, green residence. We’re exploring solutions for providing sustainable post-disaster housing with OutBack.”
—Steven Lefler, Modular Lifestyles



“With OutBack’s all-in-one FLEXpower ONE, we delivered an off-grid solution that exceeded the customer’s expectations for quality and deployment.”
—Jason Parker, Certified Solar Solutions, LLC

“OutBack Power’s products made it easy for us to fine tune and customize systems, and the tech support is great. Our customers are impressed by the results, and OutBack’s strong reputation in the industry gives them additional assurance as they transition to solar power.”
—James Bartley, Skywire Electrical Systems



“We use OutBack products for the USDA Rural Electrification program in New Mexico and our other hundreds of installations.”
—Odes Armijo-Caster, Sacred Power Corporation



“OutBack has powered 12 remote projects with the Wildlife Conservation Network (WCN) without a single failure or problem. Given OutBack’s success in previous projects in extreme, remote locales, we exclusively use them to provide off-grid solar energy to the conservation project.”
—Stephen Gold, Wildlife Conservation Network



INTEGRATION PRODUCTS

Integrated Combiner Solutions

FLEXware ICS	66
FLEXware ICS Plus	67
FLEXware PV Combiner Box Series	68

Mounting Plates

FLEXware 500 and FLEXware 1000	69
--------------------------------------	----

Integration Enclosures and Hardware

FLEXware 250	70-71
FLEXware 500	72-73
FLEXware 1000	74-75

Sample Bill of Materials

FLEXware 500	76
FLEXware 1000	77

Surge Suppression

FLEXware Surge Protector	78
--------------------------------	----

Auto-Transformer

PSX-240	79
---------------	----



FLEXware™ ICS

Integrated Combiner Solution



The OutBack Power FLEXware ICS combiner box is a cost-effective integrated solution for solar installations requiring basic combining and overcurrent protection needs.

The FLEXware ICS offers value, simplicity, and ease of installation in a single solution. The pre-integrated design saves labor time in the field and cuts down on installation costs.

With the new combiner boxes, OutBack achieves another first: a single-brand solution that is UL-1741 listed from roof to battery. This makes OutBack truly “one stop shopping” for any system installer or designer looking for a safe, fully-compliant solution.

Product Highlights:

- UL-1741 End-to-End Solution When Used with OutBack Power Conversion and Energy Storage Components
- Pre-Configured for Ease of Installation
- NEMA 3R Enclosure Protects Against Environmental Exposure

Models:	FWPV6	FWPV4-FH600	FWPV6-FH600
Enclosure Material	Powder-coated aluminum with stainless steel hardware	Powder-coated aluminum with stainless steel hardware	Powder-coated aluminum with stainless steel hardware
Mounting Options	Vertical wall mount, pole mount or sloped roof mount to 14 degrees incline (3 in 12 roof pitch)		
Enclosure Rating	Outdoor rainproof, UL type NEMA 3R	Outdoor rainproof, UL type NEMA 3R	Outdoor rainproof, UL type NEMA 3R
Enclosure Security	Padlock hole in chassis for up to 3/8" padlock	Padlock hole in chassis for up to 3/8" padlock	Padlock hole in chassis for up to 3/8" padlock
Output Terminals	#14 to 2/0 AWG (2.08 to 67.4 mm ²)	#14 to 2/0 AWG (2.08 to 67.4 mm ²)	#14 to 2/0 AWG (2.08 to 67.4 mm ²)
Number of Separate Output Circuits	1	1	1
Total Maximum Current	96A	64A	96A
Overcurrent Protection	Not included, can accommodate (up to 6) 600VDC fuse holders	(4) DIN rail fuse holders that can accommodate up to 20A, 600V fuses (fuses sold separately)	(6) DIN rail fuse holders that can accommodate up to 20A, 600V fuses (fuses sold separately)
Input Terminals	Cable Glands #14 to 8 AWG (2.08 to 8.4 mm ²)	Cable Glands #14 to 8 AWG (2.08 to 8.4 mm ²)	Cable Glands #14 to 8 AWG (2.08 to 8.4 mm ²)
Certifications	UL 1741, CSA 22.2, CE	UL 1741, CSA 22.2, CE	UL 1741, CSA 22.2, CE
Unit Weight (lb/kg)	2.5 / 1.1	3.2 / 1.5	3.5 / 1.6
Unit Dimensions H x D x W (in/cm)	11.5 x 8.25 x 3.75 / 29.2 x 21.0 x 9.5	11.5 x 8.25 x 3.75 / 29.2 x 21.0 x 9.5	11.5 x 8.25 x 3.75 / 29.2 x 21.0 x 9.5
ICS Accessories	FUSE-15-600VDC/10: Box of (10) x 15A fuses FUSE-20-600VDC/10: Box of (10) x 20A fuses FH-30-1000VDC-DIN: 30A, 1000VDC fuse holder		



FLEXware™ ICS Plus*

Integrated Combiner Solution for PV Rapid Shutdown and AFCI

ICSPLUS-1 Package for Battery-Based PV Systems



FWPV6-FH600-SDA



Rapid Shutdown Initiator (RSI)



BKR-CTRL-DC



PNL-75-DC-RT

OutBack provides a fully-compliant PV rapid shutdown system (PVRSS) combiner solution with the FLEXware ICS Plus. The FLEXware ICS Plus meets the following 2014 National Electric Code (NEC) requirements:

NEC 690.11—Arc fault protection (protects against arc faults due to loose connections, damaged wires or other DC component failures)

NEC 690.12—Rapid shutdown (provides a means for first responders to safely de-energize controlled conductors)

NEC 690.15—DC combiner disconnect (opens all ungrounded circuit conductors from all sources of power)

The FLEXware ICS Plus is rated to 600VDC for integration in a wide range of systems and designed for ease of service and clean wire management. Packaged systems include easy-to-order, complete solutions for battery-based systems requiring one, two or four combiner boxes, while individual components can be ordered for alternative system needs, including use with grid-direct PV inverters. When used with OutBack power conversion and energy storage components, the system will represent the only single-brand UL and NEC-compliant solution from rooftop to battery.

Product Highlights:

- An End-to-End Solution Listed to UL1741 with PVRSS
- Arc Fault Circuit Interrupter (AFCI) Listed to UL1699B with Local and Remote Indication
- Type 3R Enclosures Rated for Indoor or Outdoor Installation
- Flexible Design—install the Combiner Box Vertically or Horizontally and Mount to Racking or Under an Array
- Interoperable with Compatible Third-Party PV Rapid Shutdown Devices (PVRSE with Dry Contact)

Packages	ICSPLUS-1	ICSPLUS-2	ICSPLUS-4
Description	FLEXware ICS Plus package for battery-based PV systems	FLEXware ICS Plus package for battery-based PV systems	FLEXware ICS Plus package for battery-based PV systems
Compatibility	Six PV strings (one charge controller)	Twelve PV strings (two charge controllers)	Twenty-four PV strings (four charge controllers)
Combiner Box	(1) FWPV6-FH600-SDA	(2) FWPV6-FH600-SDA	(4) FWPV6-FH600-SDA
RSI	1	1	1
BKR-CTRL-DC	1	1	1
Relay-Trip Breaker	PNL-75-DC-RT	PNL-75D-DC-RT	PNL-75Q-DC-RT
Rapid Shutdown	Yes	Yes	Yes
External Disconnect	Yes	Yes	Yes
PV AFCI	Yes	Yes	Yes

FLEXware ICS Plus Components	Combiner Box	RSI	DC Breaker Control & Power Supply	Relay-Trip Breakers
Description	FLEXware ICS Plus DC combiner box with PV rapid shutdown, AFCI and disconnecting means compatible with up to 6 PV strings, opens up controlled conductors within 10ft of PV array	FLEXware ICS Plus RSI initiates a PV rapid shutdown event and provides indication for solar status and AFCI	FLEXware ICS Plus combiner box, RSI, battery bank and relay-trip breakers	75A, 300VDC relay-trip breakers that open up controlled conductors at or near the charge controller or inverter in a rapid shutdown event. Available for 1, 2 or 4 poles.
Part Number	FWPV6-FH600-SDA	RSI	BKR-CTRL-DC	PNL-75-DC-RT / PNL-75D-DC-RT / PNL-75Q-DC-RT
Dimensions H x W x D (in/cm)	15.5 x 19.5 x 4.5 / 39.4 x 49.5 x 11.4	12.0 x 7.0 x 5.0 / 30.5 x 17.8 x 12.7	Width Only: Varies from .75-2.0 / 1.9-5.1	Width Only: Varies from 1.5/3.9 to 3.8/9.6
Weight (lb/kg)	~12 / 5.4	~4 / 1.8	—	—
Certifications	UL1741 with PVRSS, UL 1699/1699B, CSA 22.2 107.1-01 with PVRSS, FCC Part 15 Class B			



FLEXware™ PV Combiner Box Series

Advanced Photovoltaic Combiner

FLEXware PV Combiner Boxes

The FLEXware PV Combiner Box Series provides installers with essential, proven, and simple-to-use PV balance-of-system hardware. Ideal for both small and large systems, the FLEXware PV8 and FLEXware PV12 accommodates an application's overcurrent protection requirements. From 150VDC breakers to 600VDC fuse holders, the FLEXware PV Combiner Box Series handles it all.

Designed to survive in outdoor environments, the rainproof, UL-type 3R powder-coated aluminum chassis can be mounted on a wall, sloped roof or pole. The unique angled negative terminal bus bar design makes wiring fast and easy without the common problem of larger output conductors blocking access to the smaller input terminals. Dual output lug terminals are included for up to 2/0 AWG conductors. The tinted flame-retardant polycarbonate "dead" front panel creates a clean appearance while preventing accidental contact with the live terminals and is easily removable during installation.



Models:	FWPV-8	FWPV-12
Enclosure Material	Powder-coated aluminum with stainless steel hardware	Powder-coated aluminum with stainless steel hardware
Mounting Options	Vertical wall mount, pole mount or sloped roof mount to 14 degrees incline (3 in 12 roof pitch)	Vertical wall mount, pole mount or sloped roof mount to 14 degrees incline (3 in 12 roof pitch)
Enclosure Rating	Outdoor Rainproof, NEMA 3R	Outdoor Rainproof, NEMA 3R
Enclosure Security	Padlock hole in chassis and cover for up to 3/8 inch padlock	Padlock hole in chassis and cover for up to 3/8 inch padlock
Output Terminals*	#14 to 2/0 AWG (2.08 to 67.4 mm ²)	#14 to 2/0 AWG (2.08 to 67.4 mm ²)
Number of Separate Circuits	One circuit	One or two circuits
Total Maximum Current	120A	180A
Number of 150VDC Breakers	Up to 8	Up to 12 (two groups of 6)
Number of Fuse Holders	Up to 6	Up to 8 (two groups of 4)
Input Terminal	150VDC breakers: #14 to 6 AWG (2.08 to 13.3 mm ²) 600VDC fuse: #14 to 10 AWG (2.08 to 5.26 mm ²)	150VDC breakers: #14 to 6 AWG (2.08 to 13.3 mm ²) 600VDC fuse: #14 to 10 AWG (2.08 to 5.26 mm ²)
Certifications	ETL Listed to UL1741, UL67, CSA22.2 #29	ETL Listed to UL1741, UL67, CSA22.2 #29
Weight (lb/kg)	Unit: 4.4 / 2.0 Shipping: 5.5 / 2.5	Unit: 5.9 / 2.7 Shipping: 7.4 / 3.3
Dimensions H x W x L (in/cm)	Unit: 15.2 x 9.2 x 3.9 / 38.7 x 23.3 x 9.9 Shipping: 19 x 9.5 x 4.3 / 48.3 x 24.1 x 10.9	Unit: 15.2 x 12.7 x 3.9 / 38.7 x 32.2 x 9.9 Shipping: 19 x 13 x 4.3 / 48.3 x 33 x 10.9



FLEXware™ Mounting Plate

For Use with FLEXware 500 & FLEXware 1000 Enclosures

FLEXware Mounting Plate (MP)

The FLEXware MP is a one-piece, powder-coated aluminum mounting plate for FLEXware 500 and FLEXware 1000 enclosures. Using stainless steel mounting hardware, the integrated locating bolts make installation quick and easy by providing guides to line up enclosures and inverter/chargers. A single FLEXware MP is designed to accommodate a FLEXware 500 while two FLEXware MPs are utilized in a FLEXware 1000 configuration.

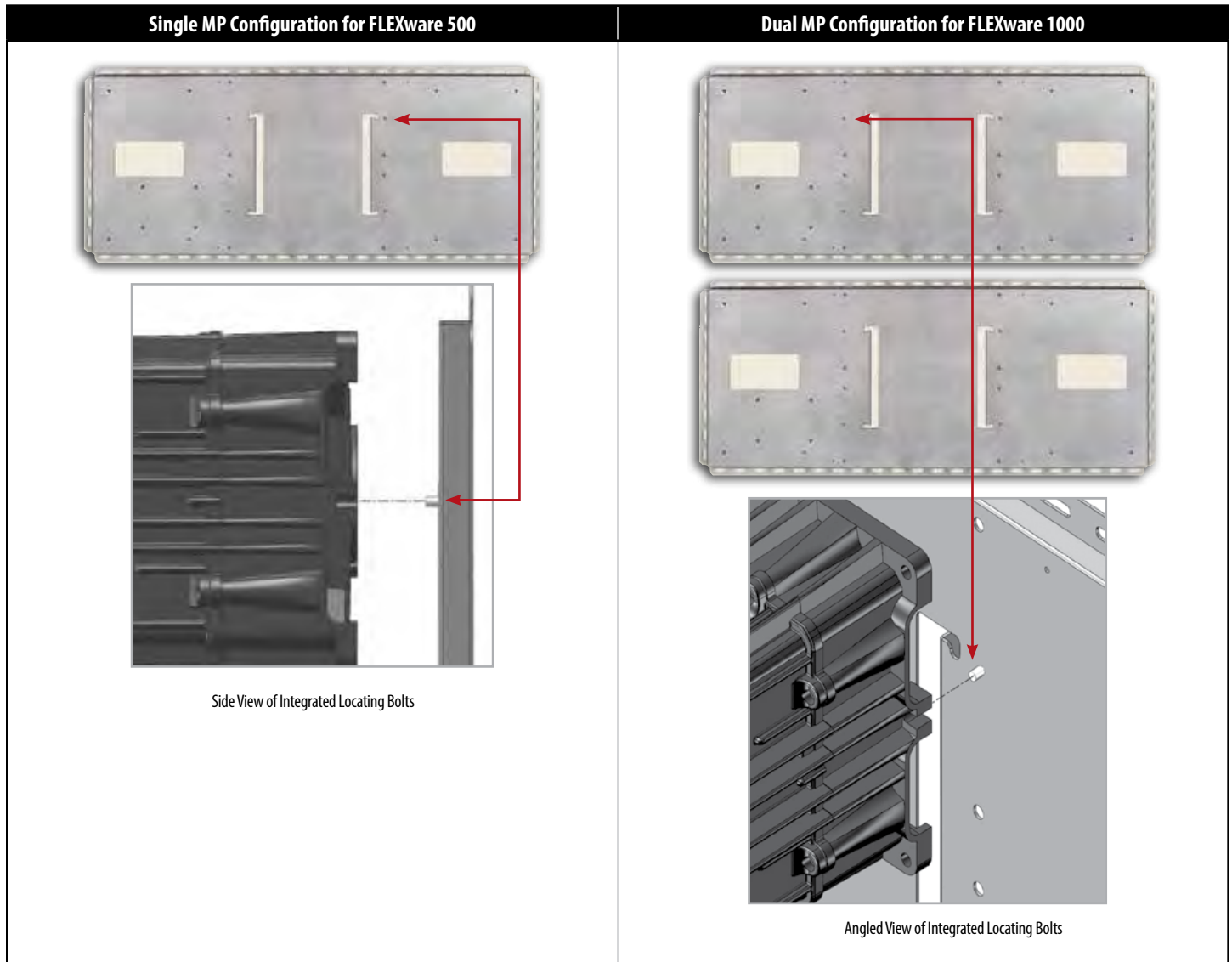

Model:	FW-MP
Description	FLEXware system mounting plate
Shipping Weight (lb/kg)	14 / 6.4
Dimensions H x W x D (in/cm)	Unit: 20.3 x 46.3 x 0.8 / 51.6 x 117.6 x 2.1 Shipping: 1.15 x 22.9 x 48.4 / 2.9 x 58.2 x 123



FLEXware™ 250

Integration Enclosures and Hardware

FLEXware 250 Integration Hardware

Designed for applications with moderate power requirements such as cabins, chalets, homes, remote communication sites and backup power systems, the FLEXware 250 accommodates all essential protective devices in the smallest possible space and at the lowest installed cost. With their extremely compact design and unique mounting features, one or two FLEXware 250 enclosures can be mounted on each end of a single FXR Series inverter/charger.

The powder-coated aluminum and ETL-listed (UL1741) FLEXware 250 enclosure provides spaces for battery, PV array or PV GFDI breakers and mounting locations for AC GFCI outlet, AC breakers and an Input-Output-Bypass Assembly. In keeping with FLEXware design concept, the FLEXware 250's flexibility is evident in the generous number of knock-outs allowing the installation of conduit, cable glands and other installation accessories.



Side View



Front View

Breaker Configuration Diagram

Holds up to four 0.75" (19 mm) wide AC rated panel mount breakers (not included with bare chassis) rated for 1-60AAC current.

Provision for optional AC Input-Output-Bypass assembly.

Holds one 120V US outlet receptacle or one 230V European outlet receptacle.

New feature includes terminal bus bar to accommodate an isolated neutral bus in AC applications.



AC Side



DC Side

Holds up to four 0.75" (19 mm) wide DC rated panel mount breakers (not included with bare chassis) rated for 1-80ADC current.

Holds one 1.5" (39 mm) wide 175 or 250A breaker, or one 1.02" (26 mm) wide 100 or 125A breaker. Includes large DC breaker handle guard.

New feature includes DC negative bus for DC applications.

Knockout Location Diagram

AC Side	<ul style="list-style-type: none"> • (1) 2" knockout (2.468" diameter) • (1) 1" knockout (1.359" diameter) 	
DC Side	<ul style="list-style-type: none"> • (1) 2" knockout (2.468" diameter) • (2) ½" knockout (0.875" diameter) 	
Front	<ul style="list-style-type: none"> • (1) 2" knockout (2.468" diameter) • (2) 1" knockout (1.359" diameter) 	
Bottom	<ul style="list-style-type: none"> • (1) 1/2" knockout (0.875" diameter) 	



FLEXware™ 250

Integration Enclosures, Hardware and Sample Bill of Materials

Model:	FLEXware 250*
Description	DC and/or AC breaker enclosure for one FXR Series inverter/charger
Includes	Ground busbar, DC breaker handle guard, breaker mounting hardware and enclosure mounting hardware
Enclosure Type	Type-1 indoor (IP30)
Shipping Weight (lb/kg)	5 / 2.3
Dimensions H x W x D (in/cm)	Unit: 7.5 x 6.5 x 8.6 / 19.1 x 16.5 x 21.8 Shipping: 9.75 x 8.4 x 11.6 / 24.8 x 21.3 x 29.5

FLEXware 250 AC Input-Output-Bypass Assemblies		
Models:	FW-IOBS-120VAC	FW-IOBS-230VAC
Description	Field-installable kit for by-passing the AC input to the AC output for inverter maintenance, testing or installation. Also provides over-current protection for AC input and output.	
Includes	(3) 60A 120VAC single pole panel mount breakers, sliding bypass interlock plate, wire and hardware kit	(3) 30A 230VAC single pole panel mount breakers, sliding bypass interlock plate, wire and hardware kit
System Rating	Single-phase 120VAC 60A 7.2kW	Single-phase 230VAC 30A 6.9kW
Bypass Breaker	One Pole @ 60A 7.2kW	One Pole @ 30A 6.9kW
Input Breaker	One Pole @ 60A 7.2kW	One Pole @ 30A 6.9kW
Output Breaker	One Pole @ 60A 7.2kW	One Pole @ 30A 6.9kW

FW-IOBS-120VAC Sample Bill of Materials (w/one OutBack VFXR3524 inverter/charger):

Part Number	Description	Quantity
VFXR3524 inverter/charger	3500W, 24VDC, 85A charger, 60AAC input	1
FW250	DC and/or AC breaker enclosure, secures directly to either end of an FXR/VFXR Series inverter/charger	2
PNL-250-DC	250A, 125VDC, 3/8" stud terminals	1
FW-IOBS-120VAC	Single inverter Input-Output-Bypass for FW250 only	1
MATE	System display and communications	1
HUB4	Four port, up to 4 devices and one MATE	1
FLEXnet DC	Multi-channel DC system monitoring device	1
FW-SHUNT250	500A, 50mVDC current shunt with attached terminal bus bar for mounting on top of an FXR/VFXR Series inverter/charger	1
FW-Cable175-15R	175A 2/0 AWG DC cable 15" (38 cm) long with ring terminals on both ends with red heat shrink	1

FW-IOBS-230VAC Sample Bill of Materials (w/one OutBack VFXR3024E inverter/charger):

Part Number	Description	Quantity
VFXR3024E inverter/charger	3000W, 24VDC, 85ADC charger, 30AAC input	1
FW250	DC and/or AC breaker enclosure, secures directly to either end of an FXR/VFXR Series inverter/charger	2
PNL-250-DC	250A, 125VDC, 3/8" stud terminals	1
FW-IOBS-120VAC	Single inverter Input-Output-Bypass for FW250 only	1
MATE	System display and communications	1
HUB4	Four port, up to 4 devices and one MATE	1
FLEXnet DC	Multi-channel DC system monitoring device	1
FW-SHUNT250	500A, 50mVDC current shunt with attached terminal bus bar for mounting on top of an FXR/VFXR Series inverter/charger	1
FW-Cable250-15R	250A, 4/0 AWG DC cable 15 inches (38 cm) long with ring terminals on both ends with red heat shrink	1

Note: This information is a sample only. Additional system configurations and components are available.

*Holds up to (8) 1 to 80A, (1) 175 or 250A panel mount breaker and GFCI AC outlet (not included).

Does not use the DCA or FW-ACA for connection to an FXR Series inverter charger. DC current shunt not included.



FLEXware™ 500

Integration Enclosures and Hardware

FLEXware 500 Integration Hardware

For applications with medium power requirements such as larger homes, light commercial or larger backup power systems, the FLEXware 500 system architecture can support up to two OutBack FXR Series inverter/chargers, up to two OutBack charge controllers and all associated AC and DC components.

With their compact design, FLEXware 500 AC and DC enclosures can mount with a FLEXware Mounting Plate in either a horizontal or vertical orientation to allow installation in more space-limited locations for a fast, professional-looking wall-mounted installation. The FLEXware 500 accommodates all of the essential protective devices in two enclosures. The powder-coated aluminum FLEXware 500 enclosure is ETL listed to UL508A.



Breaker Configuration Diagram

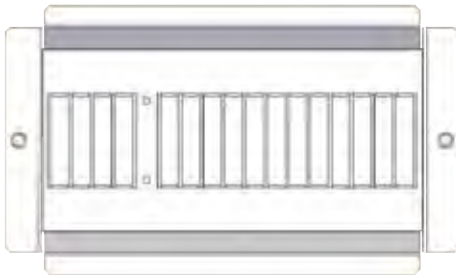

AC Side

Holds up to (16) DIN mount AC breakers (not included). Support for optional AC Input-Output-Bypass assembly. AC breakers are rated from 10-60AAC current.

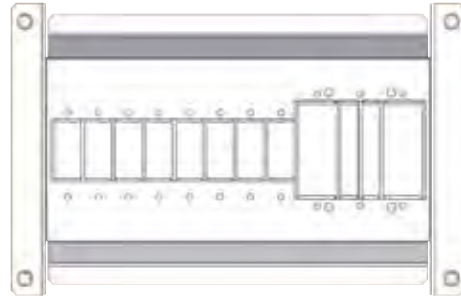

DC Side

Holds up to (8) 0.75" (19 mm) wide panel mount breakers rated for 1-80ADC current, (3) 1" (26 mm) wide breakers rated for 100 or 125ADC current, or (2) 1.5" (39 mm) wide breakers rated for 175 or 250ADC current.

Knockout Location Diagram

Left Side	<ul style="list-style-type: none"> • (5) 1" knockout (1.359" diameter) • (2) 2" knockout (2.468" diameter) • (2) Duplex GFCI outlet knockout 	
Right Side	<ul style="list-style-type: none"> • (9) 1" knockout (1.357" diameter) 	
Back Side	<ul style="list-style-type: none"> • (2) 2" knockout (2.468" diameter) 	
Bottom Side	<ul style="list-style-type: none"> • (3) 1" knockout (1.359" diameter) • (1) 3/4" knockout (1.093" diameter) • (4) 2" knockout (2.468" diameter) 	
Top Side	<ul style="list-style-type: none"> • (3) 1" knockout (1.359" diameter) • (1) 3/4" knockout (1.093" diameter) • (4) 2" knockout (2.468" diameter) 	



FLEXware™ 500

Integration Enclosures and Hardware

Models*:	FLEXware 500 DC (FW500-DC)	FLEXware 500 AC (FW500-AC)
Description	DC enclosure which mounts at the DC side of one or two FXR Series inverter/chargers. Supports up to (6) terminal bus bars (not including ground busbar) and up to three shunt assemblies depending on configuration	AC enclosure which mounts at the AC side of one or two FXR Series inverter/chargers. Supports (6) terminal bus bars and one FW-X240
Includes	Ground bus bar, 500ADC shunt assembly, positive bus, panel breaker mounting hardware, FW-BBUS and enclosure mounting hardware	Ground bus bar, DIN mounting bracket, communication cable conduit and enclosure mounting hardware
Enclosure Type	Type-1 indoor (IP30)	Type-1 indoor (IP30)
Shipping Weight (lb/kg)	15 / 6.8	15 / 6.8
Dimensions H x W x D (in/cm)	Unit: 18.2 x 11.4 x 12.1 / 46.2 x 29 x 30.7 Shipping: 14.5 x 13.4 x 20.3 / 36.8 x 34.1 x 51.6	Unit: 18.2 x 11.4 x 12.1 / 46.2 x 29 x 30.7 Shipping: 14.5 x 13.4 x 20.3 / 36.8 x 34.1 x 51.6

FLEXware 500 AC Input-Output-Bypass Assemblies			
Models:	FW-IOBD-120/240VAC	FW-IOBD-120VAC	FW-IOBD-230VAC
Description	Field-installable kit for by-passing the AC input to the AC output for inverter maintenance, testing or installation. Also provides over-current protection for AC input and output.		
Includes	(6) 60A 120VAC single pole DIN mount breakers, sliding bypass interlock plate, wire and hardware kit	(4) 60A 120VAC single pole DIN mount breakers, (1) 60A 120VAC dual pole DIN mount breaker, sliding bypass interlock plate, wire and hardware kit	(6) 30A 230VAC single pole DIN mount breakers, sliding bypass interlock plate, wire and hardware kit
System Rating	Split-phase 120/240VAC 60A 14.4kW	Single-phase 120VAC 120A 14.4kW	Single-phase 230VAC 60A 13.8kW
Bypass Breaker	Two Poles @ 60A 14.4kW	Two Poles @ 60A 14.4kW	Two Poles @ 30A 13.8kW
Input Breaker	Two Poles @ 60A 14.4kW	Two Poles @ 60A 14.4kW	Two Poles @ 30A 13.8kW
Output Breaker	Two Poles @ 60A 14.4kW	Two Poles @ 60A 14.4kW	Two Poles @ 30A 13.8kW

*The FW500 system utilizes one FW-MP (mounting plate) and a set of the DCA and FW-ACA conduit adapters for each inverter/charger. DC and AC breaker, Input-Output-Bypass assemblies and all other additional components are sold separately.



FLEXware™ 1000

Integration Enclosures and Hardware

FLEXware 1000 Integration Hardware

Designed for applications with larger power requirements such as large residential, commercial, or village power systems. The FLEXware 1000 system architecture is capable of supporting up to four OutBack FXR/VFXR Series inverter/chargers, four OutBack charge controllers, and all the required AC and DC components and wiring. With their compact design, FLEXware 1000 AC and DC enclosures accommodate all essential protective devices with ample room for additional breakers and large cable connections, and can be mounted either vertically or horizontally. The powder-coated aluminum FLEXware 1000 enclosure is ETL listed to UL508A.



Breaker Configuration Diagram

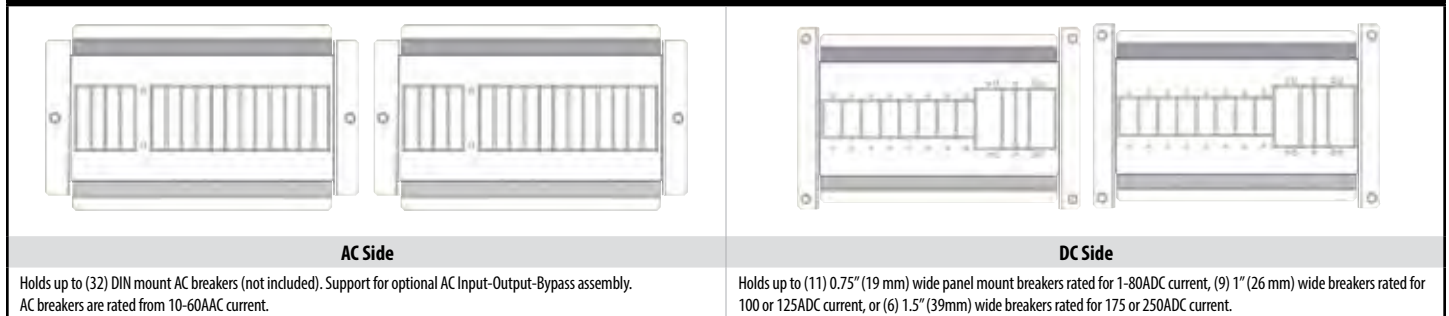

Knockout Location Diagram

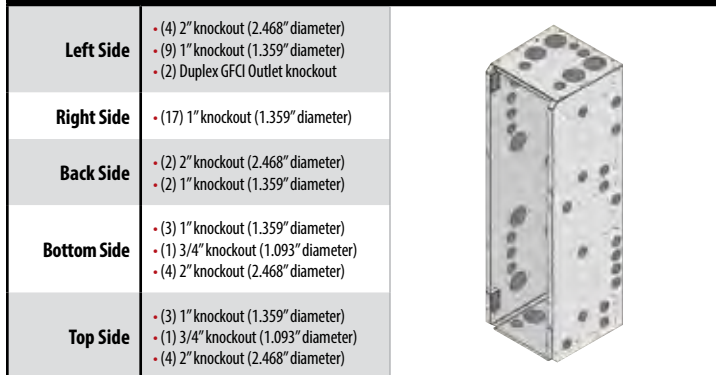



FLEXware™ 1000

Integration Enclosures and Hardware

Models*:	FLEXware 1000 DC (FW1000-DC)	FLEXware 1000 AC (FW1000-AC)
Description	DC enclosure which mounts at the DC side of three or four FXR/VFXR Series inverter/chargers. Supports up to (8) terminal bus bars (not including GBB) and up to (3) shunt assemblies depending on configuration.	AC enclosure which mounts at the AC side of three or four FXR/VFXR Series inverter/chargers. Supports (8) terminal bus bars and (1) FW-X240.
Includes	Ground bus bar, 1000ADC shunt assembly, positive bus, breaker mounting hardware, enclosure mounting hardware, two FW-SBUS and (1) FLEXware 1000 breaker bus	Ground busbar, two DIN mounting brackets and FLEXware 1000 wiring raceway
Enclosure Type	Type-1 indoor (IP30)	Type-1 indoor (IP30)
Shipping Weight (lb/kg)	21 / 9.5	21 / 9.5
Dimensions H x W x D (in/cm)	Unit: 38.5 x 11.4 x 12.1 / 97.8 x 29.0 x 30.7 Shipping: 14.5 x 13.6 x 40.6 / 36.8 x 34.5 x 103.1	Unit: 38.5 x 11.4 x 12.1 / 97.8 x 29.0 x 30.7 Shipping: 14.5 x 13.6 x 40.6 / 36.8 x 34.5 x 103.1

FLEXware 1000 AC Input-Output-Bypass Assemblies				
Models:	FW-IOBT-120/208VAC	FW-IOBT-230/400VAC	FW-IOBQ-120/240VAC	FW-IOBQ-230VAC
Description	Field-installable kit for by-passing the AC input to the AC output for inverter maintenance, testing or installation. Also provides over-current protection for AC input and output.			
Includes	(9) 60A 120VAC single pole DIN mount breakers, sliding bypass interlock plate, wire and hardware kit	(9) 30A 230VAC single pole DIN mount breakers, sliding bypass interlock plate, wire and hardware kit	(8) 60A 120VAC single pole DIN mount breakers, (2) 60A 120VAC dual pole DIN mount breakers, sliding bypass interlock plate, wire and hardware kit	(12) 30A 230VAC single pole DIN mount breakers, sliding bypass interlock plate, wire and hardware kit
System Rating	Three-phase 120/208VAC, 60A 21.6kW	Three-phase 230/400VAC, 30A 20.7kW	Split-phase 120/240VAC, 120A 28.8kW	Split-phase 230VAC, 120A 27.6kW
Bypass Breaker	Three Poles @ 60A 21.6kW	Three poles 30A 20.7kW	Four poles @60A 28.8kW	Four poles @ 30A 27.6kW
Input Breaker	Three Poles @ 60A 21.6kW	Three poles 30A 20.7kW	Four poles @60A 28.8kW	Four poles @ 30A 27.6kW
Output Breaker	Three Poles @ 60A 21.6kW	Three poles 30A 20.7kW	Four poles @60A 28.8kW	Four poles @ 30A 27.6kW

*The FW1000 system utilizes two FW-MP (mounting plate) and a set of the DCA and FW-ACA conduit adapters for each inverter/charger. DC and AC breaker, Input-Output-Bypass assemblies and all other additional components are sold separately.



Sample Bill of Materials

For FLEXware 500

FW-IOBD-120VAC Sample Bill of Materials (w/one OutBack VFXR3648 inverter/charger):

Part Number	Description	Quantity
VFXR3648 inverter/charger	3600W, 48VDC, 45A charger, 60AAC input	1
FW-ACA	AC conduit adapter for all FXR Series inverter/chargers to AC enclosure	1
DCA	DC Conduit Adapter for all FXR Series inverter/chargers to DC enclosure	1
FW500-DC	DC breaker enclosure, fits at the DC side of one or two FXR/VFXR Series inverter/chargers	1
PNL-175-DC	175A, 125VDC breaker with 3/8" stud terminals	1
FW500-AC	AC breaker enclosure, fits at the AC side of one or two FXR/VFXR Series inverter/chargers	1
FW-IOBD-120VAC	Dual inverter Input-Output-Bypass for FW500	1
FW-MP	Mounting plate for FW500 or FW1000 system	1
MATE3	System display and communications	1
HUB4	Four port, up to 4 devices and one MATE	1
FN-DC	FLEXnet DC, multi-channel DC system monitoring device	1
FW-Cable175-36R	175A 2/0 AWG DC cable 36" (91.5 cm) long with ring terminals on both ends with red heat shrink	1
FW-Cable175-36W	175A 2/0 AWG DC cable 36" (91.5 cm) long with ring terminals on both ends with white heat shrink	1

FW-IOBD-120/240VAC Sample Bill of Materials (w/dual OutBack VFXR3648 inverter/chargers):

Part Number	Description	Quantity
VFXR3648 inverter/charger	3600W, 48VDC, 45A charger, 60AAC input	2
FW-ACA	AC Conduit Adapter for all FXR/VFXR Series inverter/chargers to AC enclosure	2
DCA	DC Conduit Adapter for all FXR/VFXR Series inverter/chargers to DC enclosure	2
FW500-DC	DC breaker enclosure, fits at the DC side of one or two FXR Series inverter/chargers	1
PNL-175-DC	175A, 125VDC breaker with 3/8" stud terminals	2
FW500-AC	AC breaker enclosure, fits at the AC side of one or two FXR/VFXR Series inverter/chargers	1
FW-IOBD-120/240VAC	Dual inverter Input-Output-Bypass for FW500	1
FW-MP	Mounting plate for FW500 or FW1000 system	1
MATE3	System display and communications	1
HUB4	Four port, up to 4 devices and one MATE	1
FN-DC	FLEXnet DC, multi-channel DC system monitoring device	1
FW-X240	Auto-transformer 4kVA 120/240VAC 60Hz	1
FW-Cable175-36R	175A 2/0 AWG DC cable 36" (91.5 cm) long with ring terminals on both ends with red heat shrink	2
FW-Cable175-36W	175A 2/0 AWG DC cable 36" (91.5 cm) long with ring terminals on both ends with white heat shrink	2

FW-IOBD-230VAC Sample Bill of Materials (w/dual OutBack VFXR3024E inverter/charger):

Part Number	Description	Quantity
VFXR3024E	3000W, 24VDC, 85ADC charger, 30AAC input	2
FW-ACA	AC Conduit adapter for all FXR/VFXR Series inverter/chargers to AC enclosure	2
DCA	DC Conduit adapter for all FXR/VFXR Series inverter/chargers to DC enclosure	2
FW500-DC	DC breaker enclosure, fits at the DC side of one or two FXR/VFXR Series inverter/chargers	1
PNL-250-DC	250A, 125VDC, 3/8" stud terminals	2
FW500-AC	AC breaker enclosure, fits at the AC side of one or two FXR/VFXR Series inverter/chargers	1
FW-IOBD-230VAC	Dual inverter Input-Output-Bypass for FW500	1
FW-MP	Mounting plate for FW500 or FW1000 system	1
MATE3	System display and communications	1
HUB4	Four port, up to 4 devices and one MATE	1
FN-DC	FLEXnet DC, multi-channel DC system monitoring device	1
FW-Cable175-36R	250A 4/0 AWG DC cable 36" (91.5cm) long with ring terminals on both ends with red heat shrink	2
FW-Cable175-36W	250A 4/0 AWG DC cable 36" (91.5cm) long with ring terminals on both ends with white heat shrink	2



Sample Bill of Materials

For FLEXware 1000

FW-IOBQ-230VAC Sample Bill of Materials (w/four OutBack VFXR3048E inverterchargers in parallel):

Part Number	Description	Quantity
VFXR3048E inverter/charger	3000W, 48VDC, 45A charger, 30AAC input	4
FW-ACA	AC Conduit Adapter for all FXR/VFXR Series inverter/chargers to AC enclosure	4
DCA	DC Conduit Adapter for all FXR/VFXR Series inverter/chargers to DC enclosure	4
FW1000-DC	DC breaker enclosure, fits at the DC side of up to four FXR/VFXR Series inverter/chargers	1
PNL-175-DC	175A, 125VDC breaker with 3/8" stud terminals	4
FW1000-AC	AC breaker enclosure, fits at the AC side of up to four FXR/VFXR Series inverter/chargers	1
FW-IOBQ-230VAC	Quad inverter Input-Output-Bypass for FW1000	1
FW-MP	Mounting plate for FW500 or FW1000 system	2
MATE3	System display and communications	1
HUB10.3	Ten port, up to 10 devices and one MATE	1
FN-DC	FLEXnet DC, multi-channel DC system monitoring device	1
FW-Cable175-36R	175A 2/0 AWG DC cable 36" (91.5 cm) long with ring terminals on both ends with red heat shrink	4
FW-Cable175-36W	175A 2/0 AWG DC cable 36" (91.5 cm) long with ring terminals on both ends with white heat shrink	4

FW-IOBQ-120/240VAC Sample Bill of Materials (w/four OutBack VFXR3648 inverter/chargers in parallel):

Part Number	Description	Quantity
VFXR3648 inverter/charger	3600W, 48VDC, 45A charger, 60AAC input	4
FW-ACA	AC Conduit Adapter for all FXR/VFXR Series inverter/chargers to AC enclosure	4
DCA	DC Conduit Adapter for all FXR/VFXR Series inverter/chargers to DC enclosure	4
FW1000-DC	DC breaker enclosure, fits at the DC side of one or two FXR/VFXR Series inverter/chargers	1
PNL-175-DC	175A, 125VDC breaker with 3/8" stud terminals	4
FW1000-AC	AC breaker enclosure, fits at the AC side of one or two FXR/VFXR Series inverter/chargers	1
FW-IOBQ-120/240VAC	Tri inverter Input-Output-Bypass for FW1000	1
FW-MP	Mounting plate for FW500 or FW1000 system	2
MATE3	System display and communications	1
HUB10.3	Ten port, up to 10 devices and one MATE	1
FN-DC	FLEXnet DC, multi-channel DC system monitoring device	1
FW-X240	Auto-transformer 4kVA 120/240VAC 60Hz	1
FW-Cable175-36R	175A 2/0 AWG DC cable 36" (91.5 cm) long with ring terminals on both ends with red heat shrink	4
FW-Cable175-36W	175A 2/0 AWG DC cable 36" (91.5 cm) long with ring terminals on both ends with white heat shrink	4

FW-IOBT-120/208VAC Sample Bill of Materials (w/three OutBack VFXR3648 inverter/chargers for three-phase):

Part Number	Description	Quantity
VFXR3648 inverter/charger	3600W, 48VDC, 45A charger, 60AAC input	3
FW-ACA	AC Conduit adapter for all FXR/VFXR Series inverter/chargers to AC enclosure	3
DCA	DC Conduit adapter for all FXR/VFXR Series inverter/chargers to DC enclosure	3
FW1000-DC	DC breaker enclosure, fits at the DC side of one or two FXR/VFXR Series inverter/chargers	1
PNL-175-DC	175A, 125VDC, 3/8" stud terminals	3
FW1000-AC	AC breaker enclosure, fits at the AC side of one or two FXR/VFXR Series inverter/chargers	1
FW-IOBT-120/208VAC	Tri inverter Input-Output-Bypass for FW1000	1
FW-MP	Mounting plate for FW500 or FW1000 system	2
MATE3	System display and communications	1
HUB10.3	Ten port, up to 10 devices and one MATE	1
FN-DC	FLEXnet DC, multi-channel DC system monitoring device	1
FW-Cable175-36R	175A 2/0 AWG DC cable 36" (91.5 cm) long with ring terminals on both ends with red heat shrink	3
FW-Cable175-36W	175A 2/0 AWG DC cable 36" (91.5 cm) long with ring terminals on both ends with white heat shrink	3

Note: This information is a sample only. Additional system configurations and components are available.



FLEXware™ Surge Protector

Transient Overvoltage Surge Suppression

FLEXware Transient Surge Protectors

The FLEXware Surge Protector was designed by OutBack engineers specifically for OutBack FXR/VFXR Series inverter/chargers to provide multiple levels of protection for an inverter/charger's vital parts in the event of an electrical power surge. Ease of installation and seamless integration make it an obvious addition to any OutBack system.

Advanced design allows for both AC and DC protection on multiple circuits (two AC and one DC) via thermally fused Metal Oxide Varistors (MOVs). LED visual indicators provide at-a-glance status monitoring allowing system users to determine FLEXware Surge Protector operational status in real-time.

The FLEXware Surge Protector is designed to operate between 120 to 240VAC at 50/60Hz and 12 to 48VDC. Multiple mounting configurations allow it to be incorporated into any OutBack system for quicker installations that look as good as they perform. The FW-SP-ACA mounts inside the FW-ACA for FLEXware 500 and 1000 systems, while the FW-SP-250 is designed to mount inside the FLEXware 250 AC Side Breaker Enclosure.

The OutBack Power FLEXware Surge Protector is the logical choice for protecting an FXR/VFXR Series inverter/charger investment from the harmful effects of transient power surges.



Models:	FW-SP-ACA	FW-SP-250	FW-SP-R
Nominal Voltage	120-240VAC/12-48VDC	120-240VAC/12-48VDC	120-240VAC/12-48VDC
Voltage Protection Level	390VAC/150VDC	390VAC/150VDC	390VAC/150VDC
AC or DC	AC/DC	AC/DC	AC/DC
Maximum Surge Current (8/20µs)	30kA per circuit	30kA per circuit	30kA per circuit
Energy Rating	2500 joules	2500 joules	2500 joules
Frequency	50/60Hz	50/60Hz	50/60Hz
Protection Type	Thermally Fused MOV	Thermally Fused MOV	Thermally Fused MOV
Number of Protected Circuits	(2) AC and (1) DC	(2) AC and (1) DC	(2) AC and (1) DC
Mounting	FW-ACA	FW-250	Replacement Board (FW-SP-ACA, FW-SP-250)
Operating Temperature Range	-40 to 60°C	-40 to 60°C	-40 to 60°C
Weight (lb/kg)	Unit: 1.3 / 0.57 Shipping: 2.1 / 0.96	Unit: 1.15 / 0.52 Shipping: 2 / 0.91	Unit: 0.47 / 0.21 Shipping: 1.15 / 0.52
Dimensions H x W x L (in/cm)	Unit: 8.5 x 6.75 x 2.5 / 21.59 x 17.15 x 6.35 Shipping: 10.13 x 9.13 x 5.75 / 25.72 x 23.2 x 14.6	Unit: 5.5 x 6.5 x 7.5 / 13.97 x 16.51 x 19.05 Shipping: 10 x 7.25 x 6 / 25.4 x 18.42 x 15.24	Unit: 7.75 x 5.5 x 1.5 / 19.69 x 13.97 x 3.81 Shipping: 9.38 x 7.25 x 2.5 / 23.81 x 18.42 x 6.35



PSX-240

Auto-Transformer



PSX-240 Auto-Transformer

The OutBack PSX-240 (6kVA) auto-transformer can be used for step-up, step-down, generator and split-phase output balancing or as a series stacked inverter to load balancing autoformer. Incorporating a transformer with 120V/30A primary and secondary side, a temperature activated cooling fan and a 25A dual pole breaker in a steel enclosure, the PSX-240 is ready to install in your custom application. Use for 120 or 240VAC 60Hz systems only.

FW-X240 Auto-Transformer

Designed to be housed within the FLEXware 500 or FLEXware 1000 AC enclosures, the FW-X240 (4kVA) auto-transformer can be used for step-up, step-down, generator and split-phase output balancing or as a series stacked inverter to load balancing autoformer. Includes transformer, 25A dual pole breaker and mounting hardware. Use for 120 or 240VAC 60Hz systems only.

Models:	PSX-240	FW-X240
Weight (lb/kg)	Unit: 37.7 / 17.1 Shipping: 39.5 / 17.9	Unit: 28.4 / 12.9 Shipping: 32.5 / 14.7
Dimensions H x W x L (in/cm)	Unit: 6.25 x 8 x 12.5 / 15.9 x 20.3 x 31.75 Shipping: 10.25 x 12.25 x 16.25 / 26 x 31.1 x 33	Unit: 5.38 x 6.38 x 5.31 / 13.67 x 16.21 x 13.49 Shipping: 10.75 x 10.75 x 10.75 / 27 x 27 x 27

Step-Up Diagram

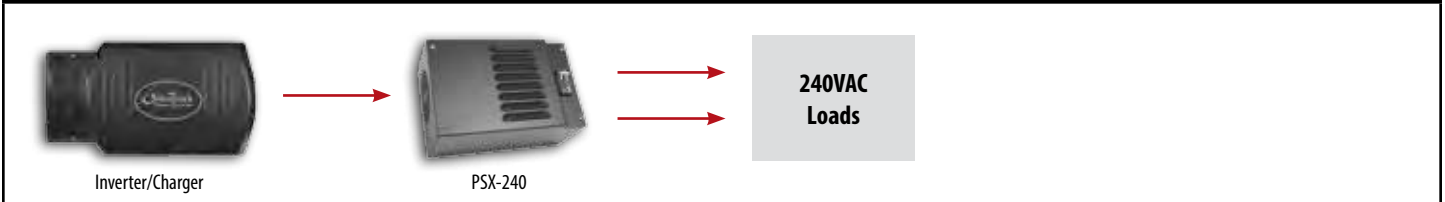

Step-Down Diagram

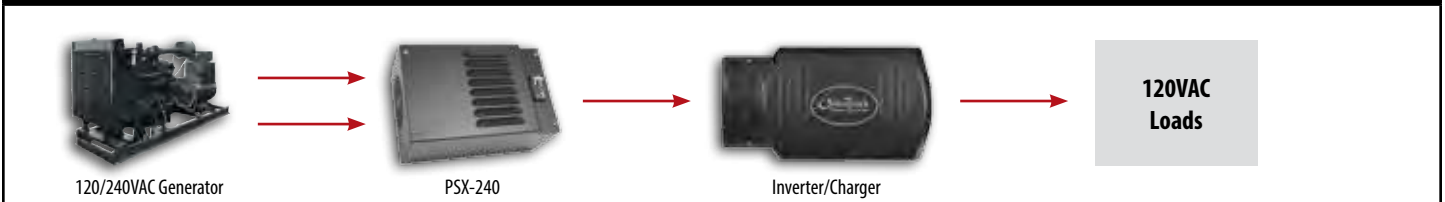

Generator Balancing Diagram

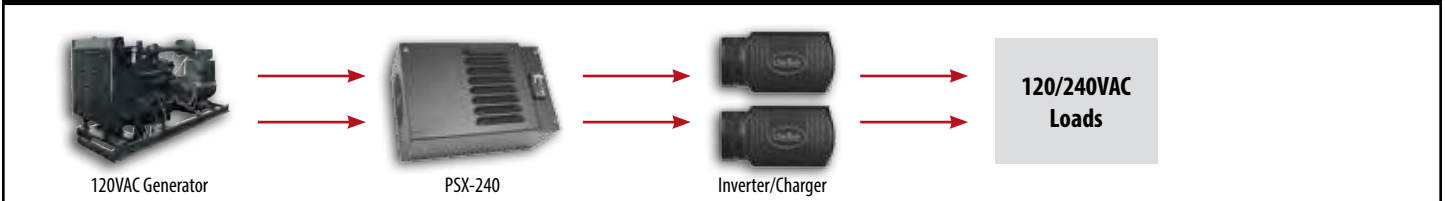

OutBack Balancing Diagram

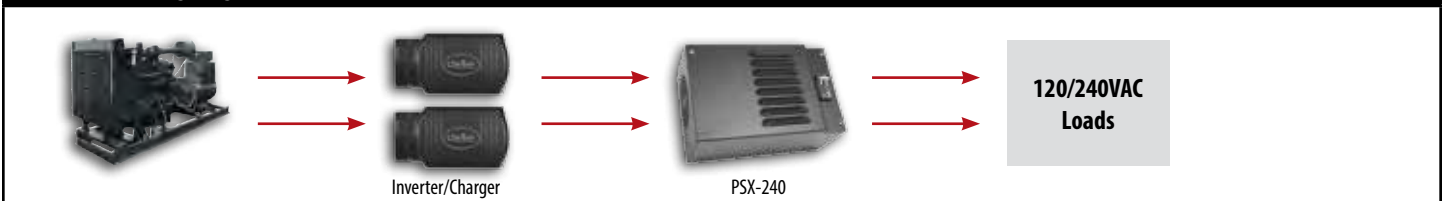



Cable Shack

600V OR 1025V-1000V
1232/1204/1338/10070 600V OR 1025V-1000V
114W FT-4 OR AWM 1232/1204/1338/10070 600V OR 1025V-1000V

5052

5052

5052

SYSTEM ACCESSORIES

Panel Mount Breakers	82
DIN Breakers.....	82
PV Ground-Fault Detection and Interruption	83
DC Bus Bars.....	83
DC Current Shunts	83
Conduit Adapters.....	84
Mounting Brackets.....	84
DIN Rail End Clamp.....	84
DC Cable Assemblies.....	85
DC DIN Mount Breakers.....	85
High Voltage DIN Mount Fuse Holders and Fuses	86
Terminal Bus Bars	86
System Stacking Configurations	87



System Components and Accessories



OutBack Panel Mount Breakers

Panel mounted hydraulic-magnetic type breakers that can be used for DC sources, inverters or load circuits

Model	Current Rating	Voltage Rating	Branch Circuit	Terminals	Width (in/mm)
PNL-1-AC/DC*	1A	150VDC 120VAC	10k AIC	1/4" stud	0.75 / 19
PNL-5-AC/DC*	5A	150VDC 120VAC	10k AIC	1/4" stud	0.75 / 19
PNL-10-AC/DC*	10A	150VDC 120VAC	10k AIC	1/4" stud	0.75 / 19
PNL-15-AC/DC*	15A	150VDC 120VAC	10k AIC	1/4" stud	0.75 / 19
PNL-20-AC/DC*	20A	150VDC 120VAC	10k AIC	1/4" stud	0.75 / 19
PNL-30-AC/DC*	30A	150VDC 120VAC	10k AIC	1/4" stud	0.75 / 19
PNL-30-AC	30A	250VAC	—	1/4" stud	0.75 / 19
PNL-40-AC/DC*	40A	150VDC 120VAC	10k AIC	1/4" stud	0.75 / 19
PNL-50-AC/DC*	50A	150VDC 120VAC	10k AIC	1/4" stud	0.75 / 19
PNL-60-AC/DC*	60A	150VDC 120VAC	10k AIC	1/4" stud	0.75 / 19
PNL-80-DC*	80A	150VDC	—	1/4" stud	0.75 / 19
PNL-100-DC	100A	125VDC	—	5/16" stud	1 / 26
PNL-125-DC	125A	125VDC	—	5/16" stud	1 / 26
PNL-175-DC	175A	125VDC	—	3/8" stud	1.5 / 39
PNL-250-DC	250A	125VDC	—	3/8" stud	1.5 / 39
PNL-50D-AC-120/240	50A (each of 2 poles)	120/240VAC	5k AIC	1/4" stud	1.5 / 39



OutBack DIN Breakers

DIN rail mountable, hydraulic-magnetic type breakers that can be used for input, output or load circuits

Model	Current Rating	Voltage Rating	Branch Circuit	Variation	Width (in/mm)
DIN-15-AC	15A	120VAC 50/60Hz	10k AIC	Single pole	0.5 / 13
DIN-15D-AC	15A	120/240VAC 50/60Hz	10k AIC	Dual pole	1 / 26
DIN-20-AC	20A	120VAC 50/60Hz	10k AIC	Single pole	0.5 / 13
DIN-20D-AC	20A	120/240VAC 50/60Hz	10k AIC	Dual pole	1 / 26
DIN-25D-AC	25A	120/240VAC 50/60Hz	10k AIC	Dual pole	1 / 26
DIN-10-AC-277	10A	277VAC 50/60Hz	—	Single pole	0.5 / 13
DIN-15-AC-277	15A	277VAC 50/60Hz	—	Single pole	0.5 / 13
DIN-30-AC-277	30A	277VAC 50/60Hz	—	Single pole	0.5 / 13
DIN-30D-AC-480	30A	277/480VAC 50/60Hz	—	Dual pole	1 / 26
DIN-30T-AC-480	30A	277/480VAC 50/60Hz	—	Three pole	1.5 / 39
DIN-50-AC-277	50A	277VAC 50/60Hz	—	Single pole	0.5 / 13
DIN-50D-AC-480	50A	277/480VAC 50/60Hz	—	Dual pole	1 / 26
DIN-50T-AC-480	50A	277/480VAC 50/60Hz	—	Three pole	1.5 / 39
DIN-60-AC-277	60A	277VAC 50/60Hz	—	Single pole	0.5 / 13
DIN-60D-AC-480	60A	277/480VAC 50/60Hz	—	Dual pole	1 / 26



System Components and Accessories

OutBack PV Ground-Fault Detection and Interruption System

Ground fault detection and interruption is required by the NEC as a safety precaution. The OutBack PV Ground-Fault Detection and Interruption System protects wiring and system components for one, two or four PV arrays when used in a GSLC, FLEXware 250, FLEXware 500 or FLEXware 1000.



Model*	Description	Terminals	Width (in/cm)
PNL-GFDI-80	PV ground-fault detector interrupter, 80A 150VDC single pole panel mount	1/4" stud	1.51 / 3.85
PNL-GFDI-80D	PV ground-fault detector interrupter, 80A 150VDC two pole panel mount	1/4" stud	2.26 / 5.73
PNL-GFDI-80Q	PV ground-fault detector interrupter, 80A 150VDC four pole panel mount	1/4" stud	3.78 / 9.59

DC Bus Bars

OutBack DC bus bars are designed to enable the most complex of code compliant DC cable connections.

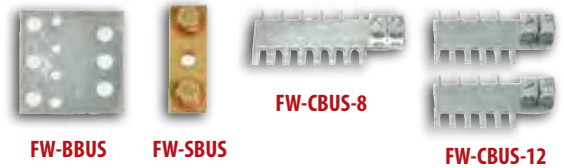

Model	Description	Includes
FW-BBUS	Breaker bus allows connection of (2) 175-250A, (3) 100-125A, (4) 1-80ADC breakers or (3) 500ADC current shunts	Plated copper plate rated for 500A
FW-SBUS	Shunt bus allows up to (4) high current cable connections on same side of DC shunt	Plated copper plate rated for 500A and (2) 5/16 inch bolts for mounting
FW-CBUS-8	Combiner bus connects up to (8) DIN mounted breakers or (6) DIN mounted fuse holders	(2) 2/0 AWG box lug terminals; plated copper
FW-CBUS-12	Combiner bus connects up to (12) DIN mounted breakers or (8) DIN mounted fuse holders	(2) 2/0 AWG box lug terminals; plated copper

DC Current Shunts

When used with an amp hour meter, OutBack Power DC current shunt kits can provide valuable insight into the status of batteries or DC power source. One shunt kit is included standard on FLEXware 500 and FLEXware 1000 DC enclosures.



Model	Description	Includes
FW-SHUNT250	500ADC current shunt with terminal bus bar for mounting on top of the FXR Series inverter/charger	Shunt, mounting hardware and terminal bus bar for connection to FXR inverter/charger's DC negative terminal
FW-SHUNT500	500ADC current shunt with terminal bus bar	Shunt, terminal bus bar and one white insulator and mounting screws

*Uses two, three or five 3/4" wide panel mount breaker spaces.



System Components and Accessories

Conduit Adapters

Allows connection of the FXR/VFXR Series inverter/chargers to FLEXware 500 and FLEXware 1000 enclosures, one FW-ACA and DCA required per FXR Series inverter/charger.

Model	Description	Includes
FW-ACA	Adapter for AC end of FXR Series inverter/charger	FW-ACA and mounting hardware
DCA	Adapter for DC end of FXR Series inverter/charger	DCA, bushing and mounting hardware

Mounting Brackets

FW-CCB and FW-CCB2 mounting brackets allow OutBack Power charge controllers to be mounted on the side of FW500-DC, FW1000-DC or GSLC enclosures. FW-CCB2-T mounting bracket allows OutBack Power charge controllers to be mounted on the top of FW500-DC or FW1000-DC enclosures. FW-MB1 mounting bracket allows mounting OutBack Power charge controllers and MATE system display and communications to FLEXware 500, FLEXware 1000 and Radian Series enclosures.



Model	Description
FW-CCB	Bracket for mounting a single FLEXmax Series charge controller on the side of FW500, FW1000 or GSLC enclosures
FW-CCB2	Bracket for mounting two FLEXmax Series charge controller on the side of FW500, FW1000 or GSLC enclosures
FW-CCB2-T	Bracket for top mounting two FLEXmax Series charge controllers on the top of FW500 and FW1000 enclosures
FW-MB1	Bracket for mounting a MATE system display on the side of FW500 and FW1000 enclosures
FW-MB2	Bracket for mounting a MATE2 system display on the side of FW500 and FW1000 enclosures
FW-MB3	Bracket for mounting a MATE3 system display on the side of Radian, GSLC, FW500 and FW1000 DC enclosures
FW-MB3-F	Flat-mount MATE3 system display mounting plate for installation over standard electrical boxes
FW-MB3-S	Surface-mount MATE3 system display mounting bracket

DIN Rail End Clamp

Model	Description	Width (in/mm)
FW-EC-DIN	DIN rail mountable securing device for DIN rail mountable fuse holders or breakers	0.4 / 10



System Components and Accessories

DC Cable Assemblies*

DC interconnect cable assemblies for wiring between inverter/chargers and breakers or DC shunts. Can also be used as battery interconnects. The THW type cable assemblies are UL listed and NEC compliant with a maximum voltage rating of 1000VDC and a temperature rating of 105°C.

Model	Description	Hole to Hole Length (in/cm)
FW-CABLE250-15R	250A 4/0 AWG (11.7 mm) DC cable 15 inches (38 cm) long with ring terminals on both ends and red heat shrink. For connection from 250ADC breaker to inverter positive terminal.	19 / 48.3
FW-CABLE175-15R	175A 2/0 AWG (9.26 mm) DC cable 15 inches (38 cm) long with ring terminals on both ends and red heat shrink. For connection from 175ADC breaker to inverter positive terminal.	40 / 101.6
FW-CABLE250-36R	250A 4/0 AWG (11.7 mm) DC cable 36 inches (91.5 cm) long with ring terminals on both ends and red heat shrink. For connection from 250ADC breaker to inverter positive terminal.	19 / 48.3
FW-CABLE175-36R	175A 2/0 AWG (9.26 mm) DC cable 36 inches (91.5 cm) long with ring terminals on both ends and red heat shrink. For connection from 175ADC breaker to inverter positive terminal.	40 / 101.6
FW-CABLE250-36W	250A 4/0 AWG (11.7 mm) DC cable 36 inches (91.5 cm) long with ring terminals on both ends and white heat shrink. For connection from DC current shunt to inverter negative terminal.	40 / 101.6
FW-CABLE175-36W	175A 2/0 AWG (9.26 mm) DC cable 36 inches (91.5 cm) long with ring terminals on both ends and white heat shrink. For connection from DC current shunt to inverter negative terminal.	40 / 101.6

OutBack DC DIN Mount Breakers

DIN rail mount breakers are hydraulic-magnetic type and are not affected by high ambient temperatures.

Model	Current Rating	Voltage Rating**	Terminals	Width (in/mm)
DIN-1-DC	1A	125VDC	#14 to 2 AWG clamp terminals	0.5 / 13
DIN-2-DC	2A	150VDC	#14 to 2 AWG clamp terminals	0.5 / 13
DIN-3-DC	3A	150VDC	#14 to 2 AWG clamp terminals	0.5 / 13
DIN-4-DC	4A	150VDC	#14 to 2 AWG clamp terminals	0.5 / 13
DIN-5-DC	5A	150VDC	#14 to 2 AWG clamp terminals	0.5 / 13
DIN-6-DC	6A	150VDC	#14 to 2 AWG clamp terminals	0.5 / 13
DIN-8-DC	8A	150VDC	#14 to 2 AWG clamp terminals	0.5 / 13
DIN-9-DC	9A	150VDC	#14 to 2 AWG clamp terminals	0.5 / 13
DIN-10-DC	10A	150VDC	#14 to 2 AWG clamp terminals	0.5 / 13
DIN-15-DC	15A	150VDC	#14 to 2 AWG clamp terminals	0.5 / 13
DIN-20-DC	20A	125VDC	#14 to 2 AWG clamp terminals	0.5 / 13
DIN-30-DC	30A	125VDC	#14 to 2 AWG clamp terminals	0.5 / 13
DIN-50-DC	50A	125VDC	#14 to 2 AWG clamp terminals	0.5 / 13
DIN-60-DC	60A	125VDC	#14 to 2 AWG clamp terminals	0.5 / 13

*All ring lugs have 3/8" (9.53mm) diameter hole.

**Approved for maximum VOC of 150VDC by ETL for PV array applications only.



System Components and Accessories

OutBack High Voltage DIN Mount Fuse Holders and Fuses

Fuse holders are DIN rail mount with #8 AWG set-screw type compression terminals. Touch-safe design and not rated for load make or load break usage.

Model	Description	Current Rating	Voltage Rating	Width (in/mm)
OBF-6-600VDC	Fuse	6A	600VDC	—
OBF-10-600VDC	Fuse	10A	600VDC	—
OBF-15-600VDC	Fuse	15A	600VDC	—
OBFH-30-600VDC-DIN	Fuse holder	30A	600VDC	0.7 / 18
FUSE-15-600VDC/10	Carton of (10) fuses	15A	600VDC	—
FUSE-20-600VDC/10	Carton of (10) fuses	20A	600VDC	—
FH-30-1000VDC-DIN	Fuse holder	30A	1000VDC	0.7 / 18

Terminal Bus Bars

Used for adding more wire terminations or for isolating multiple positive/negative circuits. All TBB models have three #1/0 to 14 AWG and eight #6 to 14 AWG screw type compression terminals, which means no ring lugs are required. Available with black, white, red, blue and brown insulators. All required TBBs are included with the AC Input-Output-Bypass Assemblies. TBBs are rated for a maximum of 180AAC/ADC.

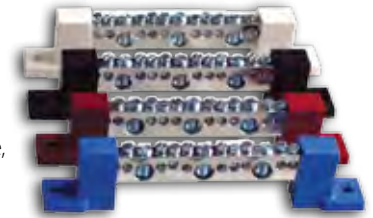

Model	Description	Terminals
TBB-GROUND	Ground/Neutral terminal bus bar and mounting screws (no insulators)	(3) #1/0 to 14 AWG and (8) #6 to 14 AWG screw type compression
TBB-BLACK	Bus bar with black insulators and mounting screws	(3) #1/0 to 14 AWG and (8) #6 to 14 AWG screw type compression
TBB-BLUE	Bus bar with blue insulators and mounting screws	(3) #1/0 to 14 AWG and (8) #6 to 14 AWG screw type compression
TBB-RED	Bus bar with red insulators and mounting screws	(3) #1/0 to 14 AWG and (8) #6 to 14 AWG screw type compression
TBB-WHITE	Bus bar with white insulators and mounting screws	(3) #1/0 to 14 AWG and (8) #6 to 14 AWG screw type compression
TBB-BROWN	Bus bar with brown insulators and mounting screws	(3) #1/0 to 14 AWG and (8) #6 to 14 AWG screw type compression



System Stacking Configurations

OutBack adheres to a philosophy that a power system should be fully customizable to address your specific needs. Therefore, the company set out to create the world's first group of inverter/chargers that use a truly modular architecture. This modular architecture uses the next generation of a technique referred to as "stacking" to enable you to tailor your system for higher output power, increased charging capabilities and/or three-phase power configuration.

Whether stacked in parallel, classic series, series/parallel or three-phase there is always an inverter/charger which performs the task of master. Depending on the model, the master talks to the other units through the HUB system communications manager while performing three major roles, keeping all inverter/chargers properly phased, controlling inverter and charger output levels, as well as putting unused inverters into "Power Save" mode to improve system efficiency at low AC load levels.

Parallel Stacking (More Power at Same Output Voltage)

When the inverter/chargers are stacked in parallel all inverter and charger outputs are combined. This means that each inverter's AC output is added up to equal your total system AC output, up to 36,000W, in phase at the same 120VAC/60Hz or 230VAC/50Hz output voltage, or 80,000W at 120/240VAC/60Hz with the Radian Series.

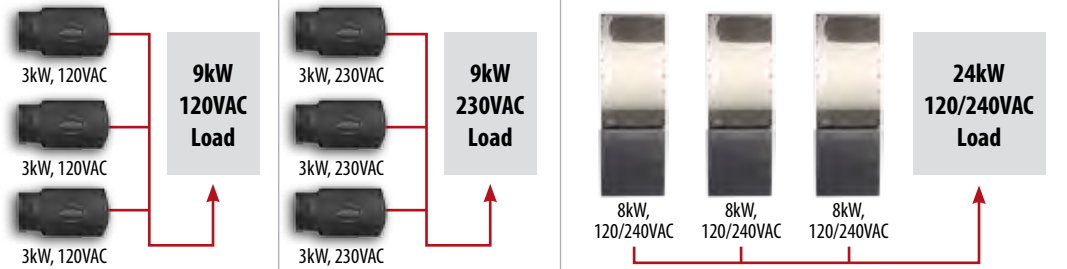

Classic Series Stacking (More Power at Higher Output Voltage)

Stacking inverter/chargers in classic series provides a system with split phase 120/240VAC. This method does not allow balancing between separate legs on a system and can only be used in dual inverter/charger systems without an Auto Transformer.

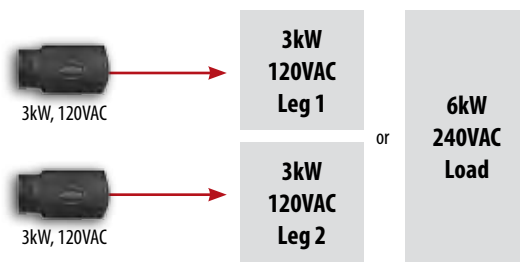

OutBack Series/Parallel Stacking (More Power at All Output Voltage)

Series/parallel stacking or OutBack stacking is unique to OutBack inverter/chargers. Never before has it been possible to have inverter/chargers balancing loads intelligently between two legs of AC power while seamlessly changing between series and parallel. OutBack stacking uses the PSX-240 auto transformer to balance the loads between the two separate legs of a system. The PSX-240 allows AC loads on leg 1 and leg 2 to be powered by any combination of inverter/chargers within your system. Even if there are only two inverter/chargers, connected in series, they can function as if connected in parallel. This allows larger AC loads to be operated by a system without risking overloading one of the 120VAC outputs.

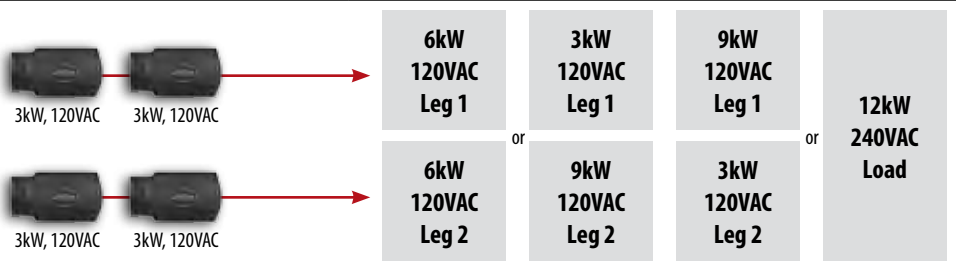

Three-Phase Stacking (More Power for Three-Phase Loads)

Three inverter/chargers can be configured to provide 120/208VAC or 230/400VAC four wire "WYE/Star" three-phase AC Power. An inverter/charger is used to power each of the three legs for three-phase AC power. The loads on each of the inverters do not need to be kept balanced—each phase is independently voltage regulated.

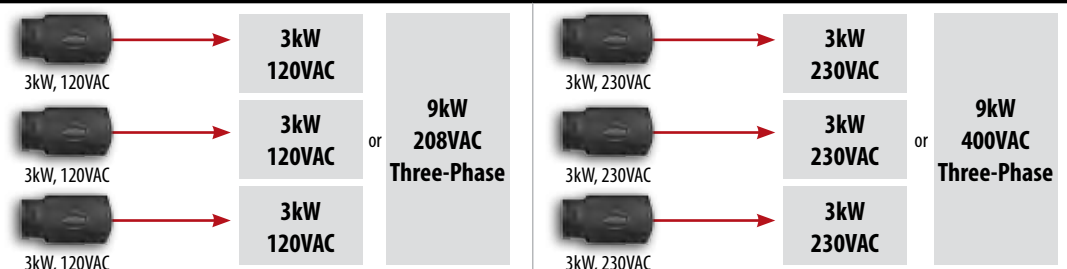

Note: Not all configurations are available with all models.

OutBack POWER™

member of The  Group™

www.outbackpower.com



Corporate Headquarters

17825 59th Ave NE, Suite B
Arlington, WA 98223
United States

Tel: +1 360.435.6030
Fax: +1 360.435.6019

Central & Latin America

15105 Cedar Bluff Pl
Wellington, FL 33414
United States

Tel: +1 360.392.2593
Fax: +1 561.792.7157

Europe

Hansastraße 8
D-91126
Schwabach, Germany

Tel: +49 9122 79889 0
Fax: +49 9122 79889 21

Asia Pacific

Suite 1903, Tower 1,
China Hong Kong City
33 Canton Road, Kowloon
Hong Kong

Tel: +852 2736 8663

Australia & New Zealand

Suite 2 32-34 Peter Brock Drive
Eastern Creek NSW 2766
Australia

Tel: +61 (2) 8599 6960
Email: sales.oceania@outbackpower.com

India

255, Block -25
LIC Jeevan Sathi, 10th Cross
J.P.Nagar Phase I
Bangalore - 560087 Karnataka (India)

Tel: +91 8861640001