

# Mini-Com® Modular Patch Panels with Faceplates

## specifications

Modular patch panels shall consist of a metal panel with molded snap-in faceplates which can be front releasable. Patch panels shall accept all Mini-Com® Modules for UTP, STP, fiber, or A/V applications and shall mount to standard 19" racks. Patch panels shall be available in 24 and 48-port standard density and 72-port high density. Angled patch panels shall be designed at an optimum angle to help route the cable.



## technical information

<b>Mounting options:</b>	Mounts to standard EIA 19" racks or 23" racks with optional extender brackets
<b>Material:</b>	Stamping is CRS and faceplate is ABS
<b>Packaging:</b>	Packaged with appropriate pre-installed snap-in faceplates, a set of mounting screws (#12-24), and label/label cover where applicable

## key features and benefits

<b>Removable faceplates</b>	Allow front accessibility to installed modules for easy moves, adds, and changes
<b>Modular</b>	Accepts all Panduit® Mini-Com® Modules to mix and match media types in the same panel
<b>Angled design</b>	Allows cable to flow to each side of the rack and minimizes the need for horizontal cable managers by enabling patch cords to be routed directly into vertical cable managers which leads to increased closet density
<b>Recessed design</b>	Eliminates patch cord interference with cabinet doors and improves bend radius protection
<b>Optional label</b>	Available with and without labels to accommodate various needs
<b>Optional strain relief bars</b>	Help support and manage cables
<b>Optional filler panels</b>	Fill unused rack openings to provide a clean and consistent look
<b>High density</b>	More modules per rack space

## applications

Mini-Com® Modular Patch Panels are ideal for multi-media applications; they accept all Mini-Com® Modules, which can be accessed through the front of the panel to snap in and out for easy moves, adds, and changes. Various styles and port densities available to fit most needs; labeling feature available on select styles. Angled patch panels are

available for applications in which rack space is limited. The design allows cable to flow to each side of the rack, minimizing the need for horizontal cable managers and increasing the density of the rack space.

### Patch Panels with Labels

<b>24-port, 1 RU, includes six CFFPL4 faceplates:</b>	CPPL24WBLY
<b>48-port, 2 RU, includes twelve CFFPL4 faceplates:</b>	CPPL48WBLY
<b>24-port, 1 RU, includes four 6-port faceplates:</b>	CPPL24M6BLY
<b>48-port, 2 RU, includes eight 6-port faceplates:</b>	CPPL48M6BLY
<b>72-port, 2 RU (high-density), includes six 12-port faceplates:</b>	CPPL72WBLY

### Patch Panels without Labels

<b>24-port, 1 RU, includes six CFFP4 faceplates:</b>	CPP24WBLY
<b>48-port, 2 RU, includes twelve CFFP4 faceplates:</b>	CPP48WBLY

### Angled Patch Panels with Labels

<b>24-port, 1 RU, includes six CFFPL4 faceplates:</b>	CPPLA24WBLY
<b>48-port, 2 RU, includes twelve CFFPL4 faceplates:</b>	CPPLA48WBLY
<b>72-port, 2 RU (high-density), includes six 12-port faceplates:</b>	CPPLA72WBLY

### Recessed Patch Panels with Labels

<b>24-port, 1 RU, includes six CFFPL4 faceplates:</b>	CPPL24WRBLY
---	-------------

### Label Options for Patch Panels with CFFPL4 and CFFP4 Faceplates

<b>Laser/ink Jet:</b>	C261X035Y1J
<b>TDP43ME:</b>	C261X035Y1T
<b>PanTher™ LS8E:</b>	C261X035Y1C
<b>Cougar LS9:</b>	T038X000FJC-BK

### Label Options for Patch Panels with CFPLM6BL Faceplates

<b>Laser/ink Jet:</b>	C390X030Y1J
<b>TDP43ME:</b>	C390X030Y1T
<b>PanTher™ LS8E:</b>	C390X030Y1C
<b>Cougar LS9:</b>	T031X000FJC-BK

### Strain Relief Bars

<b>Straight:</b>	SRBS19BL-XY
<b>Extended, 2":</b>	SRB19BLY
<b>With hook and loop ties:</b>	SRBM19BLY
<b>With adjustable clips:</b>	SRBWCY
<b>Deep, 5":</b>	SRB19D5BLY
<b>Deep, 7":</b>	SRB19D7BLY
<b>Multi-depth:</b>	SRB19MDBL

### Rack Filler Panels

See [www.Panduit.com](http://www.Panduit.com) or catalog for rack filler panel options.

### Extender Brackets

<b>1 RU:</b>	PEB1
<b>2 RU:</b>	PEB2

# Mini-Com® Modular Patch Panels with Faceplates

**CPPL24WBLY**

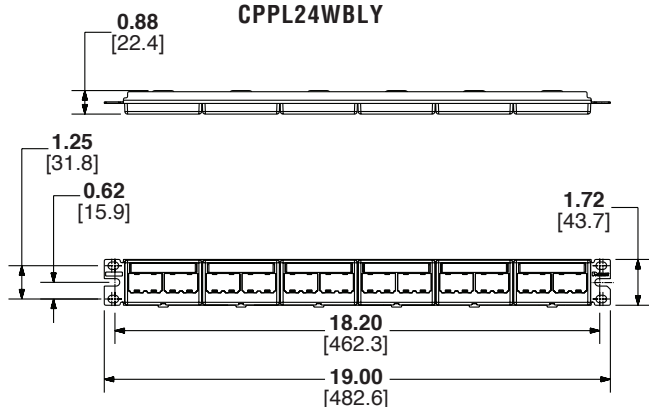

**CPPL48WBLY**

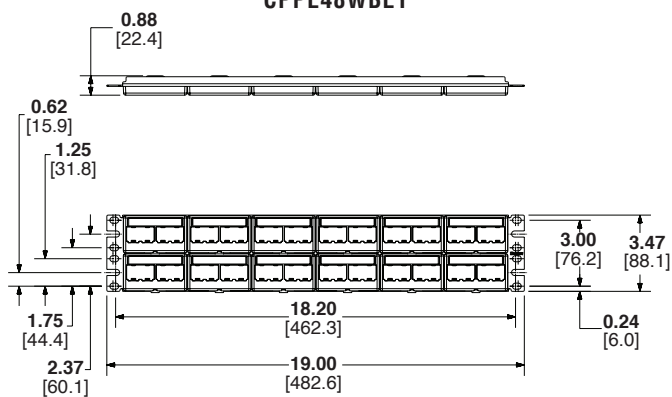

**CPPL24M6BLY**

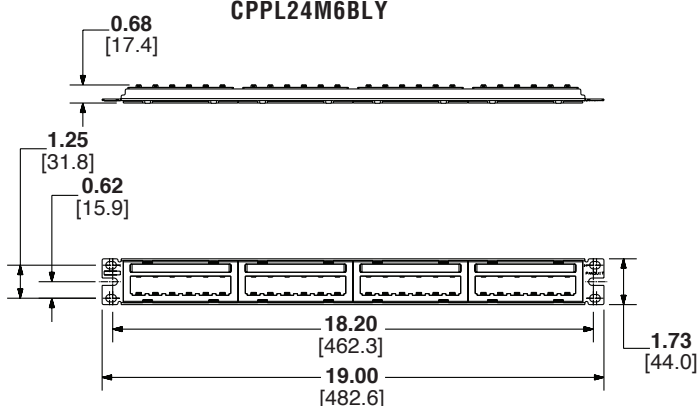

**CPPL48M6BLY**

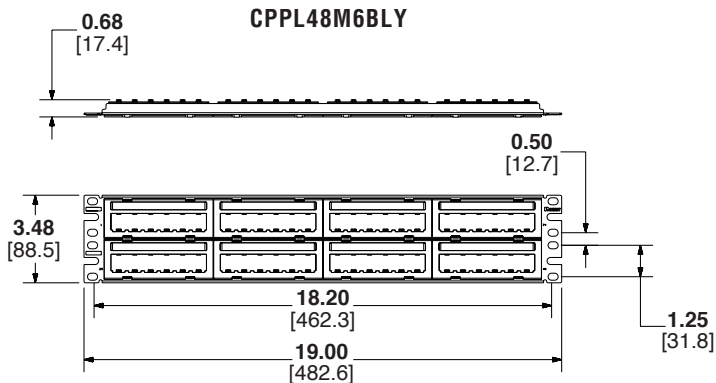

**CPPL72WBLY**

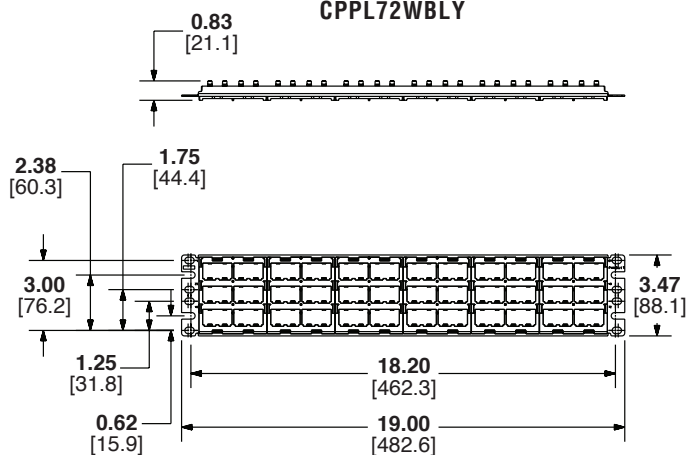

**CPP24WBLY**

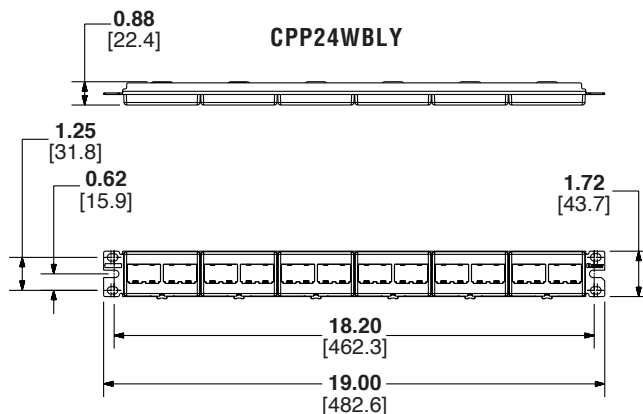

**CPP48WBLY**

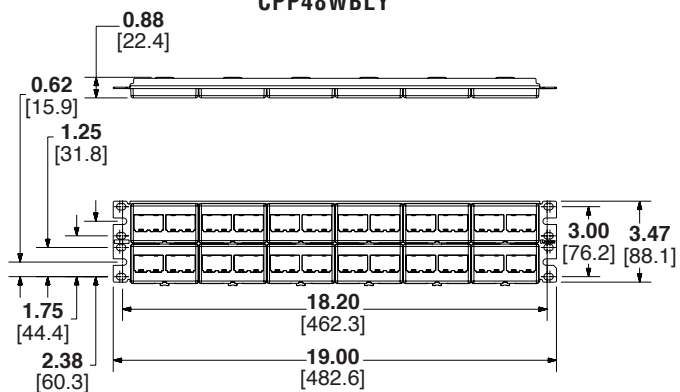

**CPPLA24WBLY**

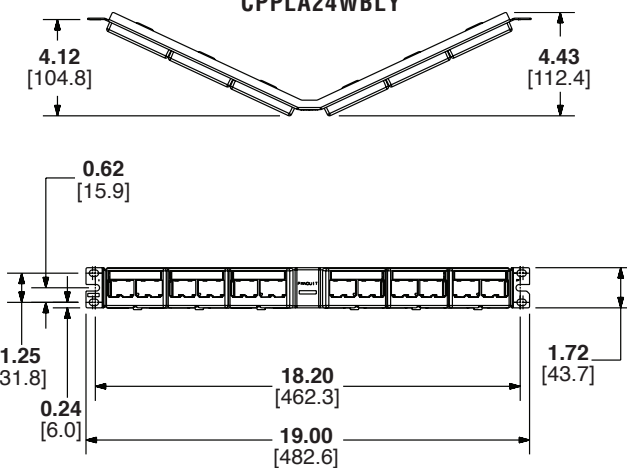

# Mini-Com® Modular Patch Panels with Faceplates

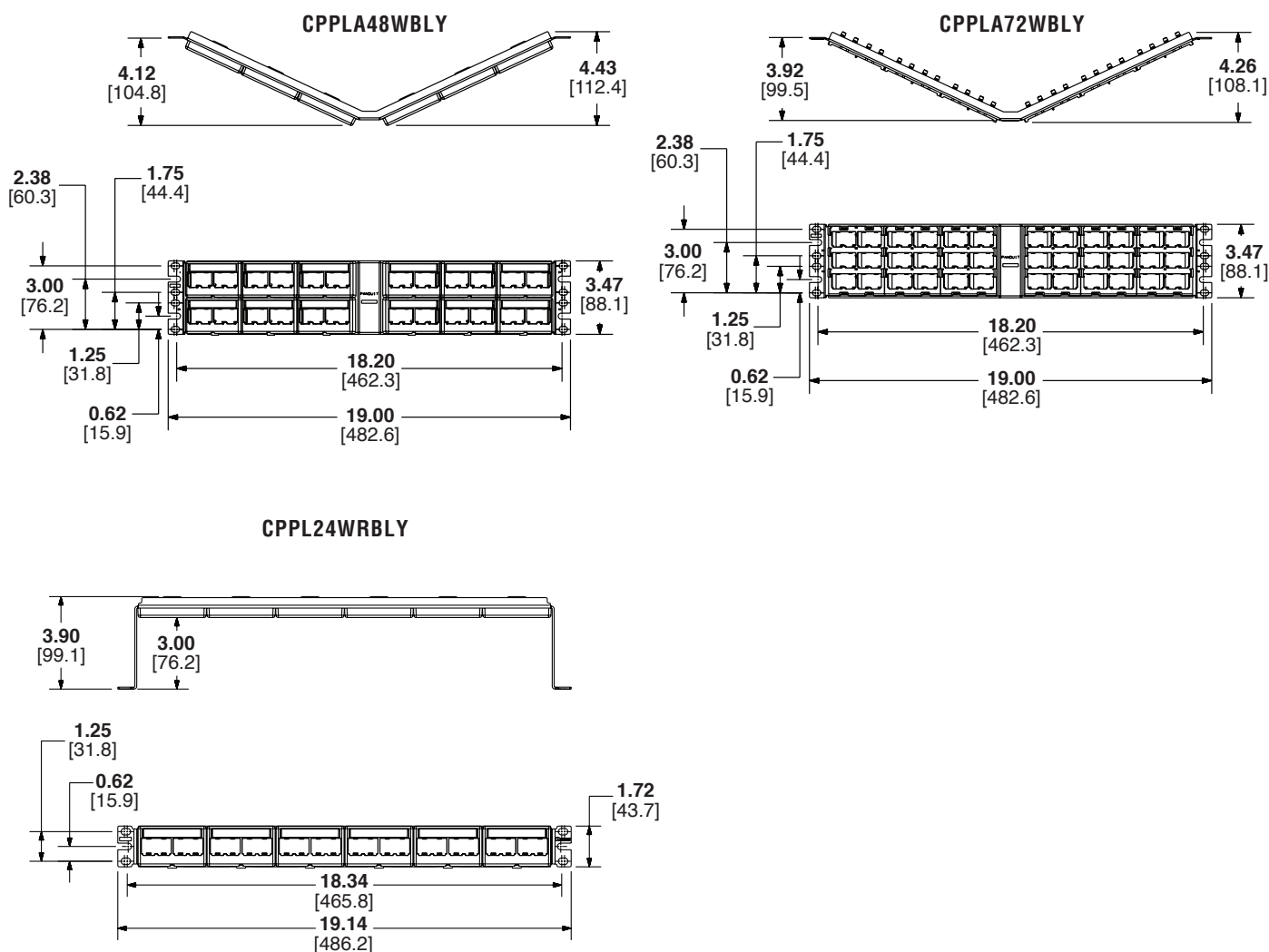

Dimensions are in inches. [Dimensions in brackets are metric].

## WORLDWIDE SUBSIDIARIES AND SALES OFFICES

PANDUIT US/CANADA  
Phone: 800.777.3300

PANDUIT EUROPE LTD.  
London, UK  
Phone: 44.20.8601.7200

PANDUIT SINGAPORE PTE. LTD.  
Republic of Singapore  
Phone: 65.6305.7575

PANDUIT JAPAN  
Tokyo, Japan  
Phone: 81.3.6863.6000

PANDUIT LATIN AMERICA  
Guadalajara, Mexico  
Phone: 52.33.3777.6000

PANDUIT AUSTRALIA PTY. LTD.  
Victoria, Australia  
Phone: 61.3.9794.9020

For a copy of Panduit product warranties, log on to [www.panduit.com/warranty](http://www.panduit.com/warranty)

For more information  
Visit us at [www.panduit.com](http://www.panduit.com)  
Contact Customer Service by email: [cs@panduit.com](mailto:cs@panduit.com)  
or by phone: 800.777.3300

**PANDUIT**®

© 2020 Panduit Corp.  
ALL RIGHTS RESERVED.  
OTSP29--WW-ENG  
Replaces WW-OTSP23  
3/2020