

INSTRUCTIONS CM344C

© Panduit Corp. 2016

Power Outlet Unit (POU) Mounting Bracket Locations for Typical Tool-less Mounting Button Spacing

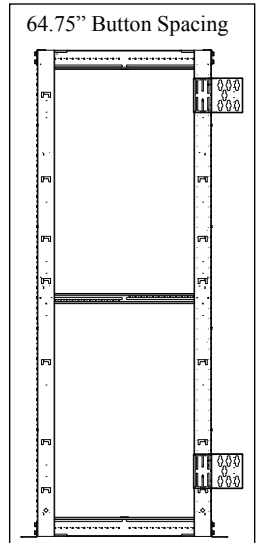
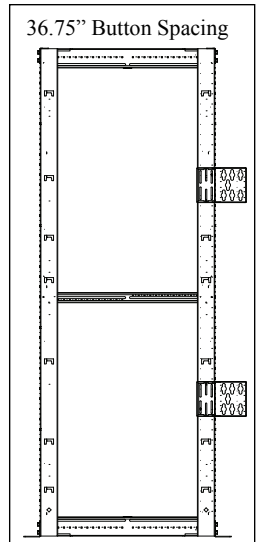
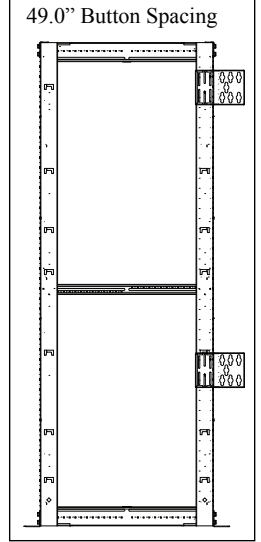
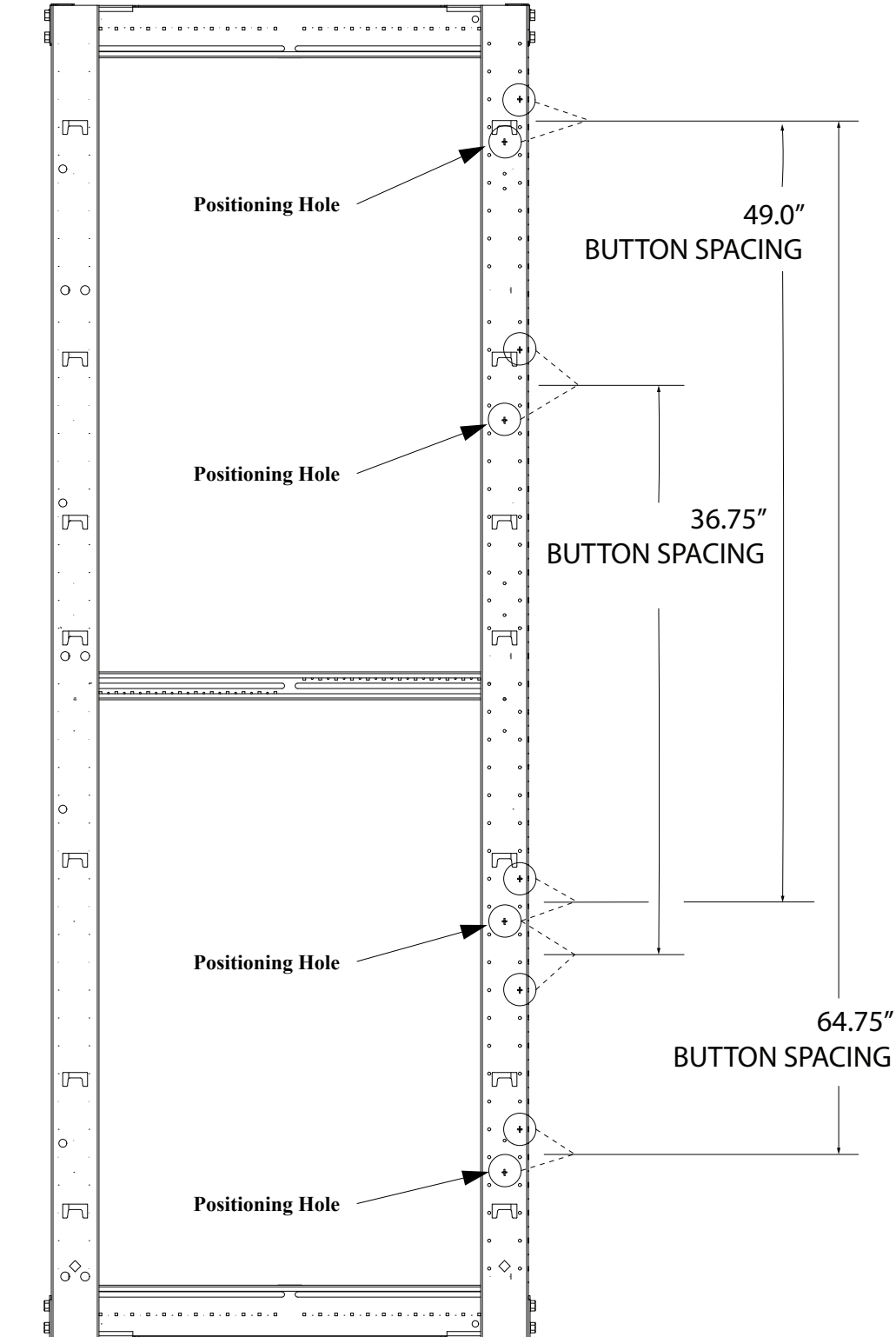

Power Outlet Unit (POU) Mounting Bracket Locations

Note location of #12-24 positioning screw in each spacing scenario. Install the positioning screw first to help locate the bracket in the correct location and orientation relative to the cabinet frame. See page 3 for bracket and screw installation instructions.

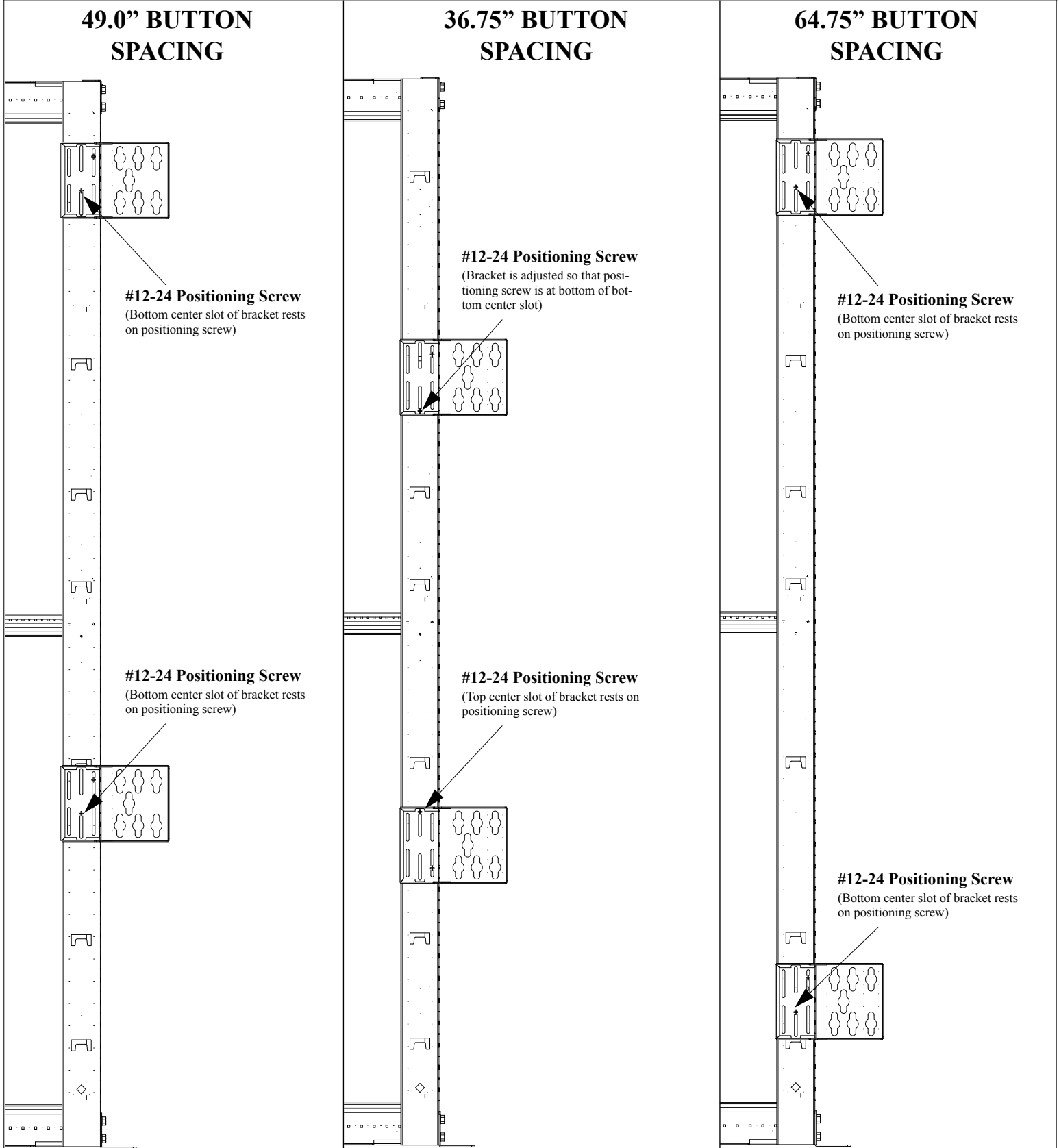

Power Outlet Unit (POU) Mounting Bracket Installation (CVPDUB)

Use two (2) #12-24 trilobular screws to mount each CVPDUB bracket to rack. Tighten screws to 45 in-lb (+/- 5 in-lb). Refer to Pages 1 and 2 for hole and slot orientation. Install buttons of Power Outlet Unit (POU) into CVPDUB bracket as shown.

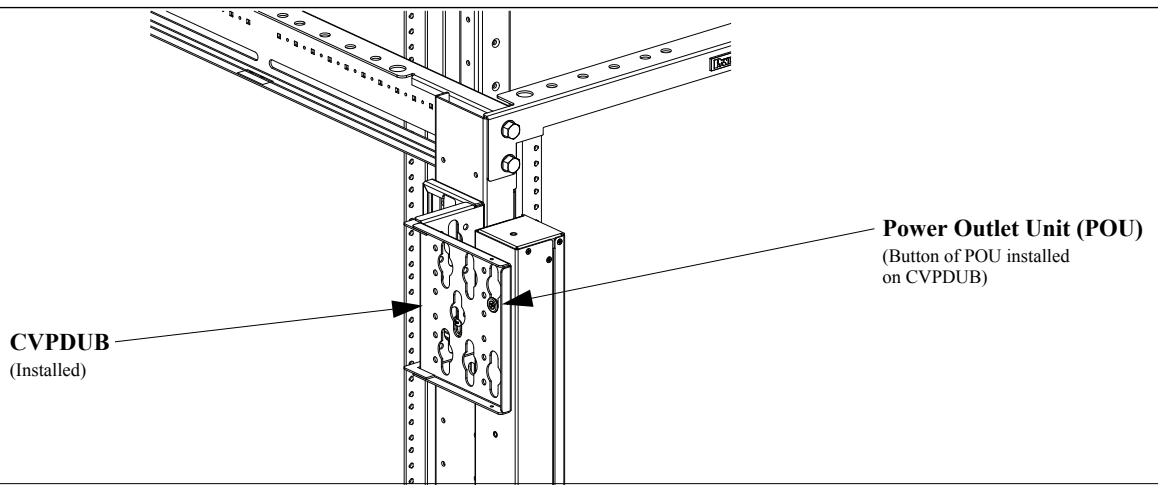
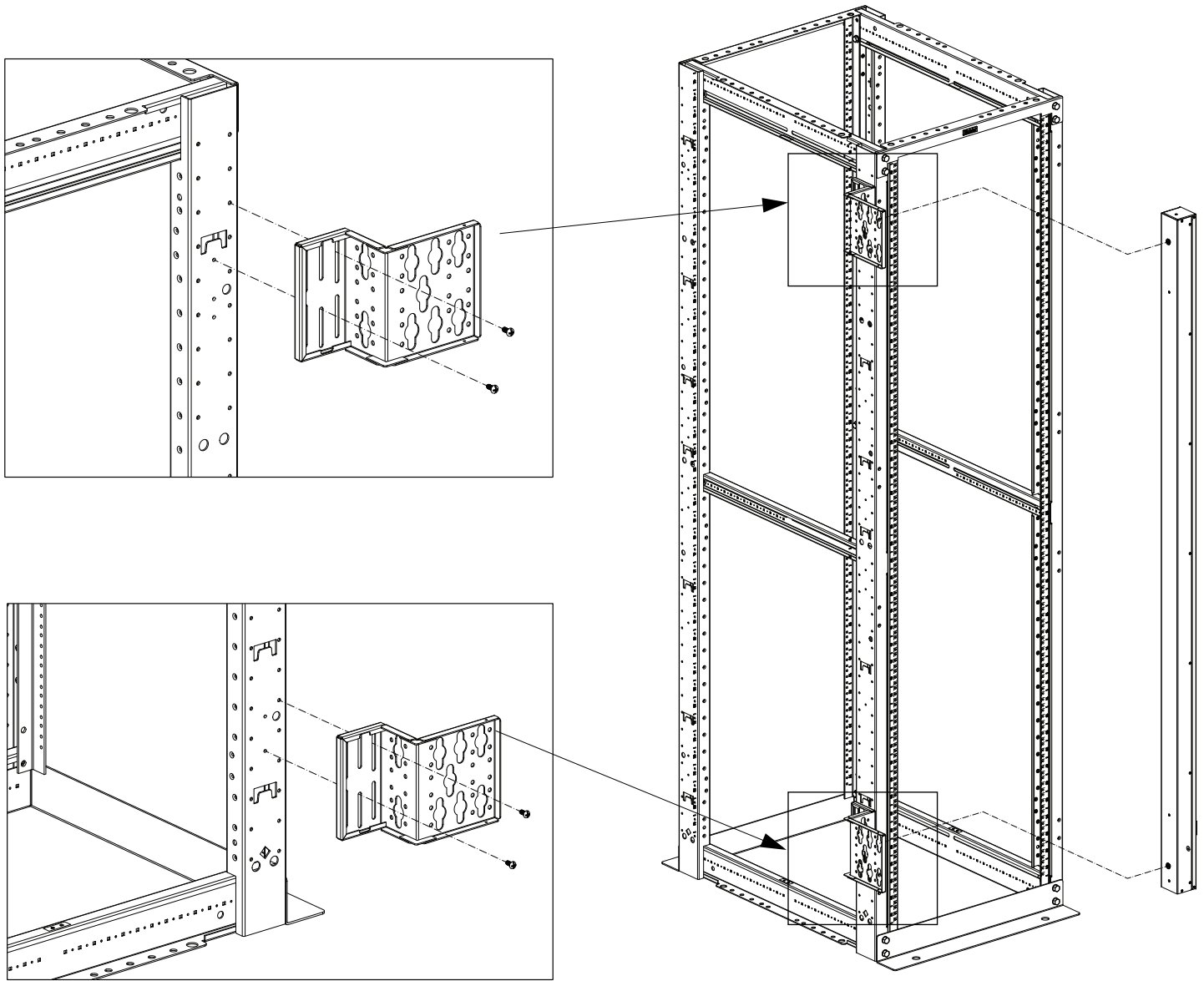

Power Outlet Unit (POU) Mounting Bracket Installation (*non-typical button spacing*)

If POU does not employ typical button spacing, mount top bracket first to locate POU. Mount lower bracket in appropriate position utilizing bonus holes.

