

THIS COPY IS PROVIDED ON A RESTRICTED BASIS AND IS NOT TO BE USED IN ANY WAY DETRIMENTAL TO THE INTERESTS OF PANDUIT CORP.

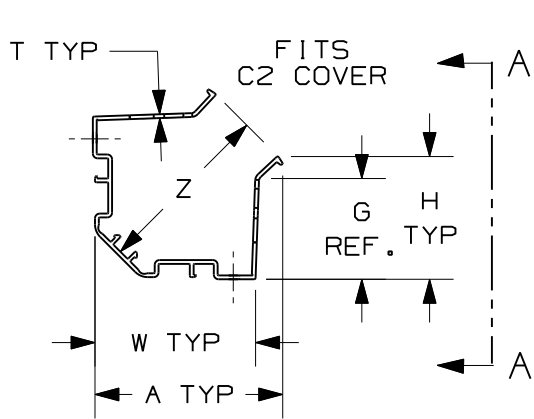

CWD 2"

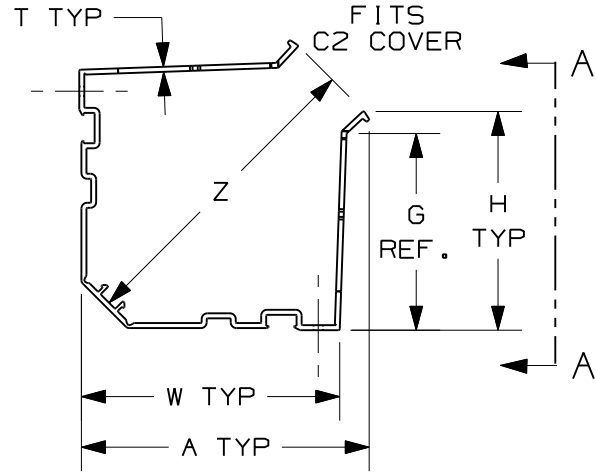

CWD 3" & 4"

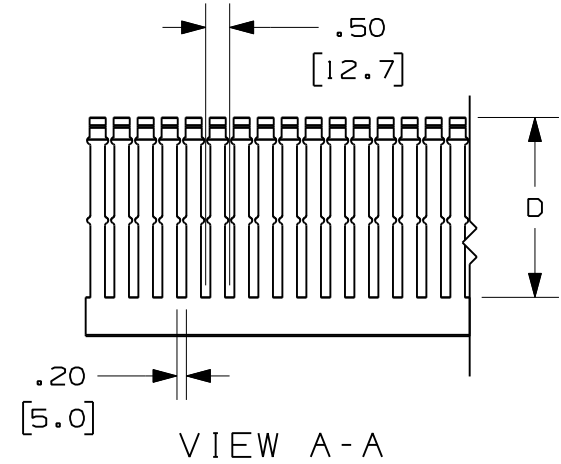

VIEW A-A

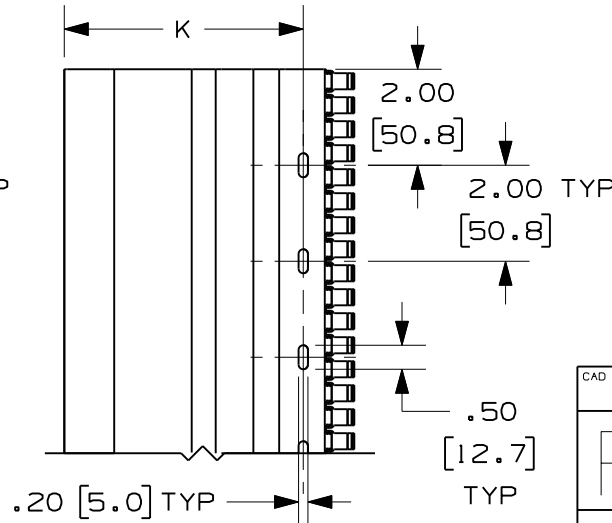
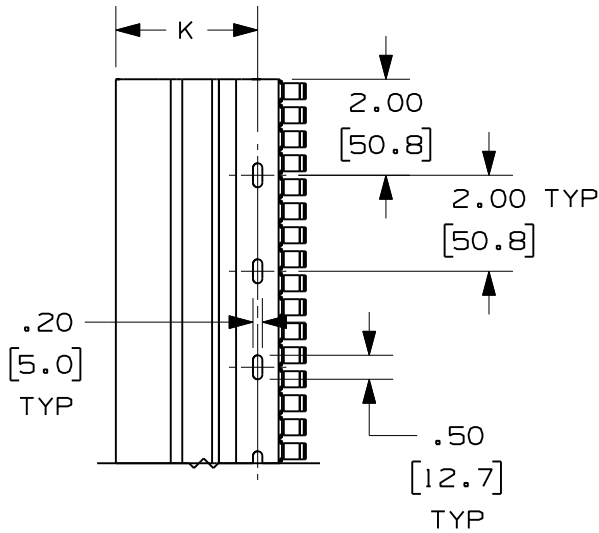

NOTES:



1. "W" MEASURED AT BASE.
2. STANDARD LENGTH: 6ft. (1.83m)
3. SEE CURRENT CATALOG FOR ADDITIONAL PART NUMBER SUFFIXES TO INDICATE COLOR AND OR PACKAGE QUANTITY.
4. FOR USE WITH C2**6 COVER. (SEE DRAWING # 34518-17.)
5. FOR USE WITH CDCLP2, CDCLP3 OR CDCLP4. (SEE DRAWING # 39178-04.)
6. FOR USE WITH CDLB3 OR CDLB4. (SEE DRAWING # 39257-07.)

CAD FILENAME/LAYERS D39210AB_DC_CWD/03A

PANDUIT CORP. TINLEY PARK, ILLINOIS

WIRING DUCT SPECIFICATIONS
TYPE "CWD" CORNER DUCT
CUSTOMER DRAWING

REV	DATE	BY	CHK	DESCRIPTION	ECN	R	CUST	SUP
				F. CHANGED DIMENSIONS				
2	4-19-12	JCST	MRJS	E. ADDED / UPDATED NOTES ABOUT CLIPS D. ADDED CWD2 PRODUCT AND SHEET 2	39210-03	RAMI	RAMI	
--	-----	---	---	C. CHANGED DECIMAL PLACES TO .XX	-----	---	---	
1	5-9-06	JCST	JKG	B. DUAL DIMENSIONED CHART A. UPDATED GEOMETRY / DIMENSIONS	39210-03	JKG	JKG	
R	1-26-06	JCST	JKG	DRAWING RELEASED TO PRODUCTION	39210-03	JKG	JKG	

UNLESS OTHERWISE SPECIFIED, DIMENSIONAL TOLERANCES ARE:
(.X) ± .1 (.25) (.XXX) ±
(.XX) ± .04 (.1) ANGLES ±





UNLESS OTHERWISE SPECIFIED, ALL DIMENSIONS ARE GIVEN IN INCHES, THIRD ANGLE PROJECTION.

DRAWN BY JCST
DATE 1-26-06
CHK'D JKG

MAT'L: PVC

SCALE NONE
DRAWING NO. 39210-03
SHEET 1 OF 2
DWG SIZE A

THIS COPY IS PROVIDED ON A RESTRICTED BASIS AND IS NOT TO BE USED IN ANY WAY DETRIMENTAL TO THE INTERESTS OF PANDUIT CORP.

PART NO.	A	D	G	H	K	T	W	Z
 CWD2**6	3.91 99.3	1.81 45.9	2.10 53.4	2.57 65.3	2.93 74.3	.08 2.0	3.35 85.0	3.72 94.6
  CWD3**6	4.98 126.6	2.83 71.8	3.10 79.1	3.57 90.7	3.88 98.6	.10 2.4	4.40 111.8	5.16 131.0
  CWD4**6	5.94 150.9	3.84 97.5	4.10 104.1	4.58 115.7	4.93 125.2	.11 2.7	5.33 135.3	6.54 166.0

** = COLOR

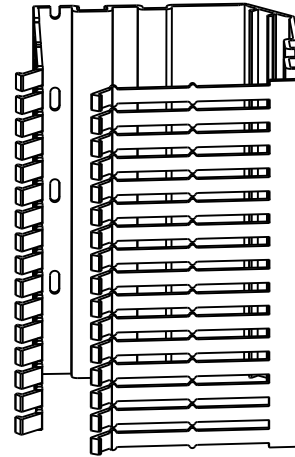
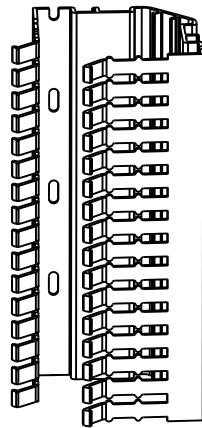



CAD FILENAME/LAYERS		D39210AB_DC_CWD/03A	
 CORP. TINLEY PARK, ILLINOIS			
WIRING DUCT SPECIFICATIONS TYPE "CWD" CORNER DUCT CUSTOMER DRAWING			
UNLESS OTHERWISE SPECIFIED, DIMENSIONAL TOLERANCES ARE:		UNLESS OTHERWISE SPECIFIED, ALL DIMENSIONS ARE GIVEN IN INCHES, THIRD ANGLE PROJECTION.	
(.X) ± .1 (.25) (.XXX) ± (.XX) ± .04 (.1) ANGLES ±		SCALE NONE	
DRAWN BY JCST		MAT'L: PVC	
DATE 1-26-06		DRAWING NO. 39210-03	
CHK'D JKG		SHEET 2 OF 2	
		DWG SIZE A	

REV	DATE	BY	CHK	DESCRIPTION	ECN	R	CUST	SUP
2	4-19-12	JCST	MRJS	SEE SHEET 1 FOR REVISIONS	39210-03		RAMI	RAMI
1	5-9-06	JCST	JKG	SEE SHEET 1 FOR REVISIONS	39210-03		JKG	JKG
R	1-26-06	JCST	JKG	SEE SHEET 1 FOR REVISIONS	39210-03		JKG	JKG