

Cutting Shielded Wiring Duct to Required Length

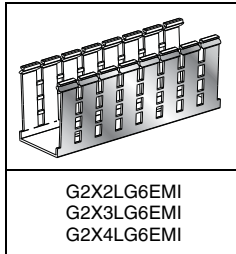

G2X2LG6EMI
G2X3LG6EMI
G2X4LG6EMI

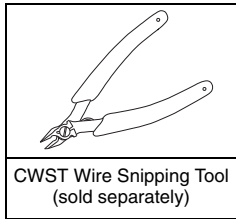

CWST Wire Snipping Tool
(sold separately)

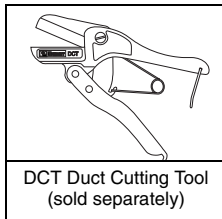

DCT Duct Cutting Tool
(sold separately)

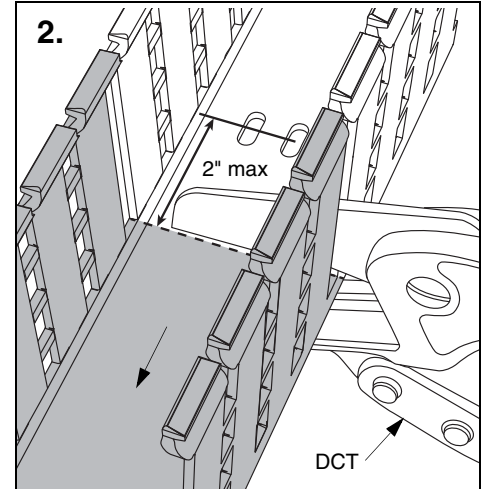
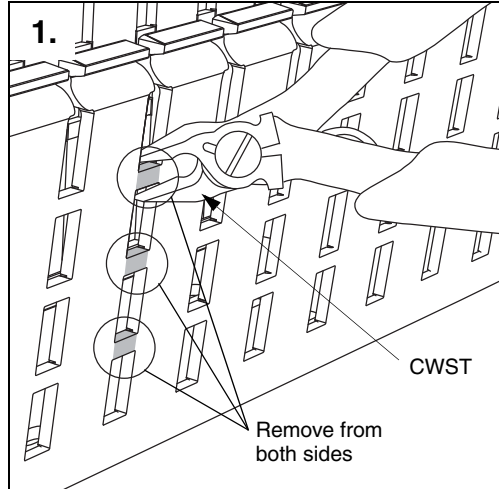

Surface Preparation for Good Electrical Bond

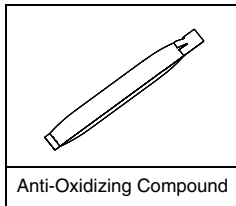

Anti-Oxidizing Compound

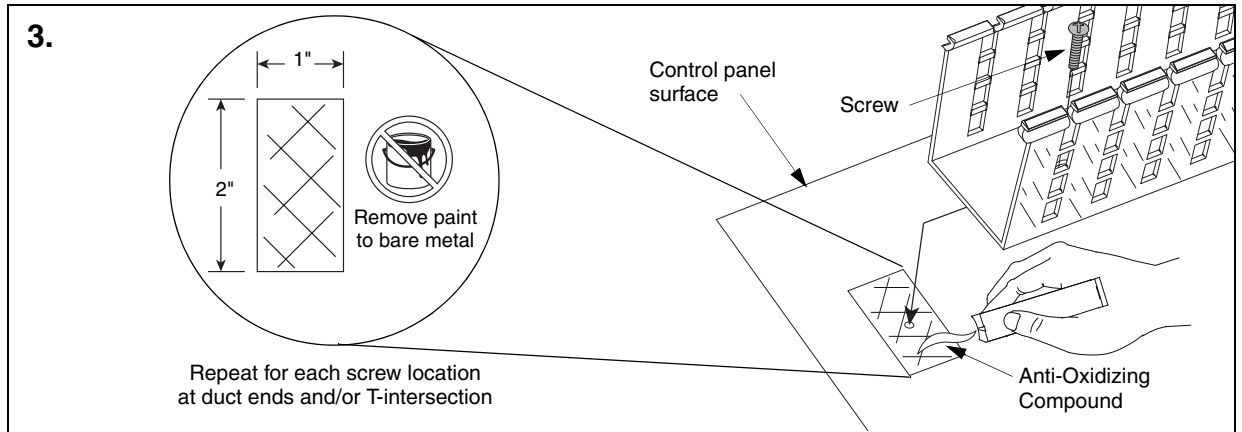

Installing One Shielded Wiring Duct

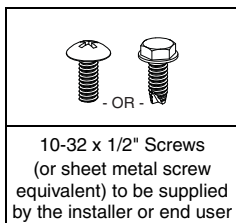

10-32 x 1/2" Screws
(or sheet metal screw
equivalent) to be supplied
by the installer or end user

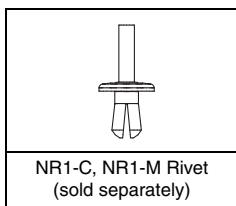

NR1-C, NR1-M Rivet
(sold separately)

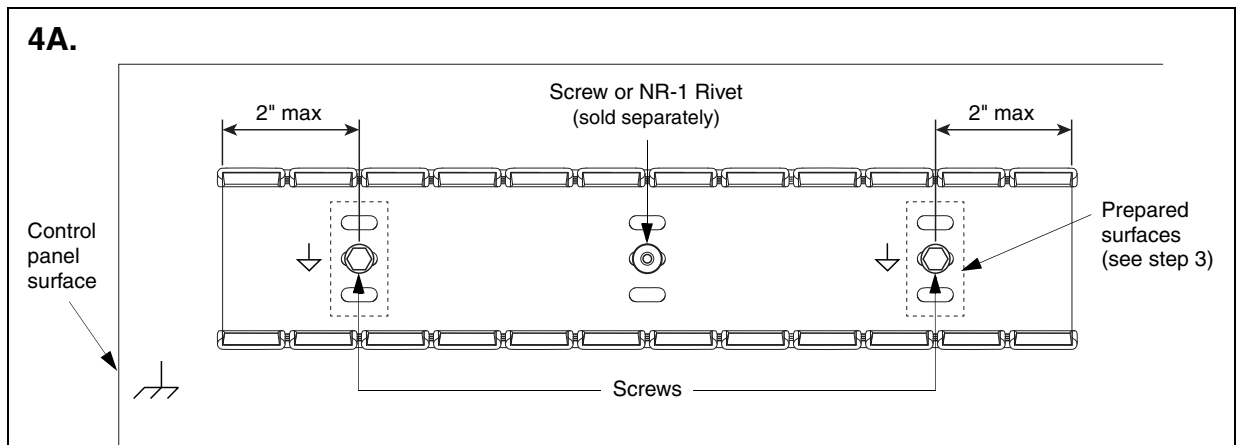

Installing Two Shielded Wiring Duct in a T-Intersection

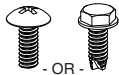

10-32 x 1/2" Screws
(or sheet metal screw
equivalent) to be supplied
by the installer or end user

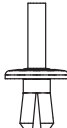

NR1-C, NR1-M Rivet
(sold separately)

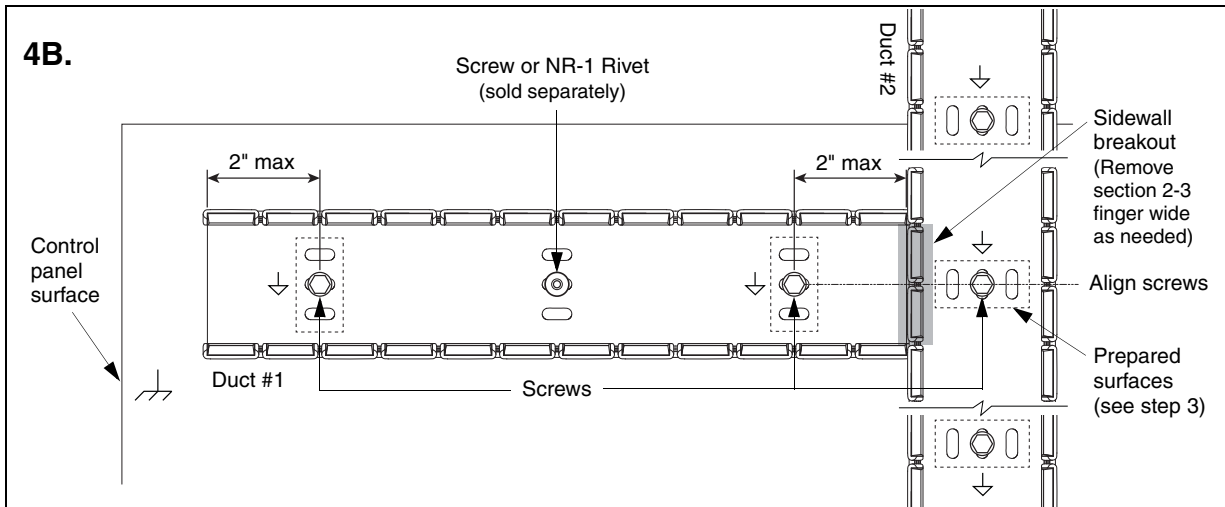

Optional - Sidewall Breakout for Creating T-Intersection

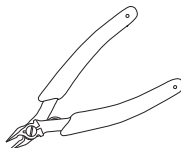

CWST Wire Snipping Tool
(sold separately)

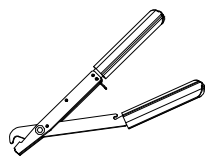

DNT-100 Duct Notching
Tool (sold separately)

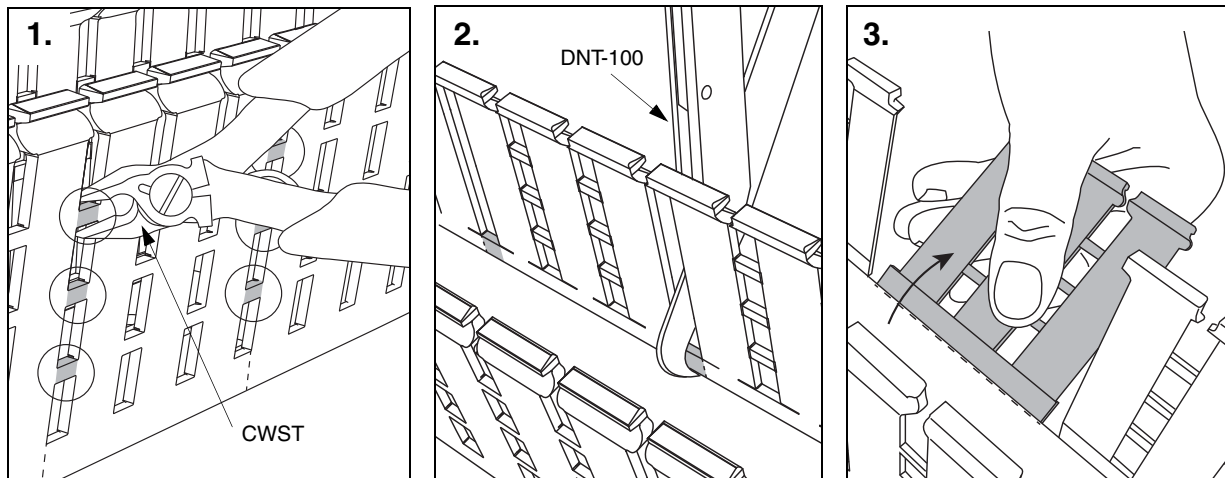

Optional - Sidewall Finger Removal

**Remove Only
As Required**

Removing bridge
connectors
between fingers
will reduce local
noise reduction
capability.

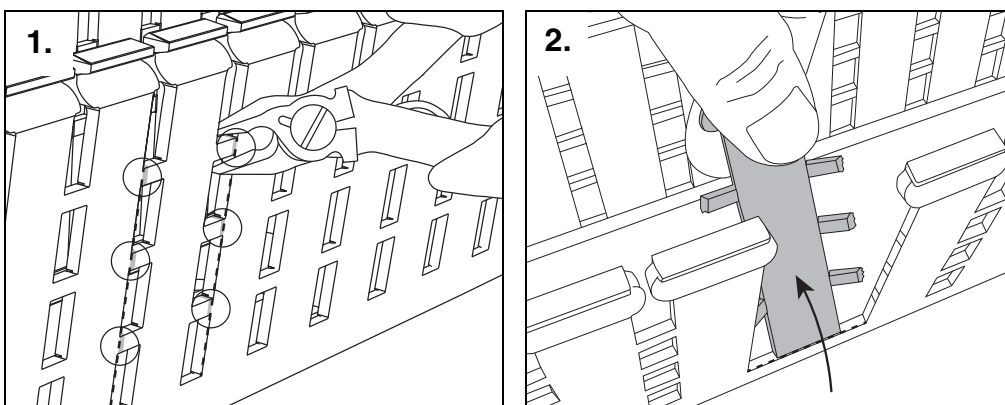

! CAUTION
Foil edges may
be sharp.

For Use of Panduct PanelMax Noise Shield (SD2EMI, SD3EMI, SD4EMI) with Panduct PanelMax Shielded Wiring Duct, Reference Installation Instructions RW260

<p>For Instructions in Local Languages and Technical Support: www.panduit.com/resources/install_maintain.asp</p>	 www.panduit.com	<p>E-mail: cs@panduit.com Fax: (815) 328-2001</p>
--	---	--