

THIS COPY IS PROVIDED ON A RESTRICTED BASIS AND IS NOT TO BE USED IN ANY WAY DETRIMENTAL TO THE INTERESTS OF PANDUIT CORP.

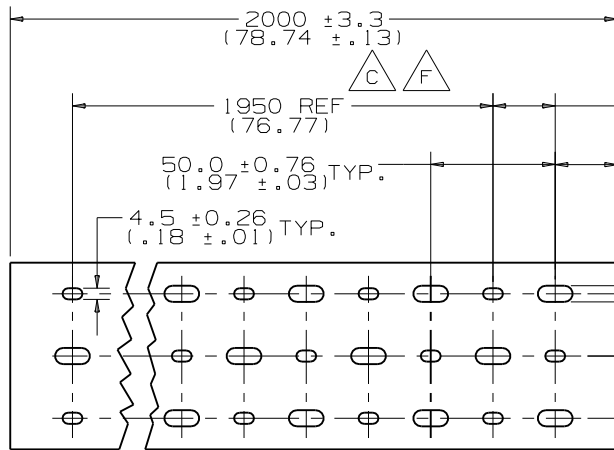

FOR 75mm, 100mm, WIDTH DUCT
MOUNTING HOLE DIMENSIONS

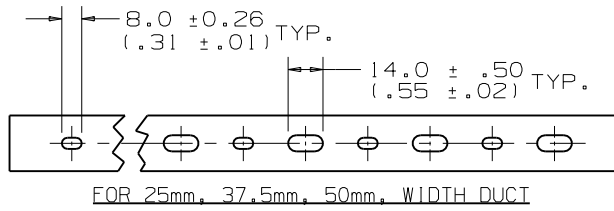
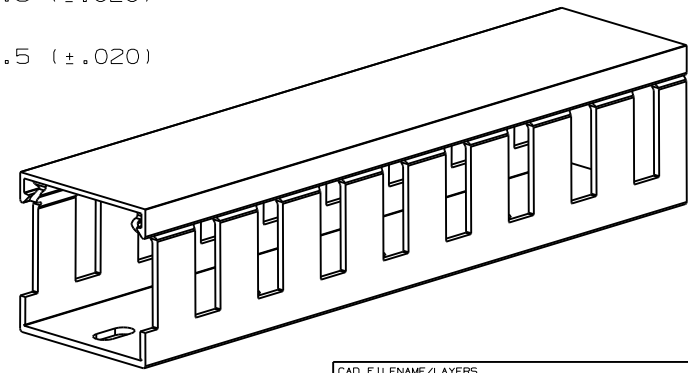
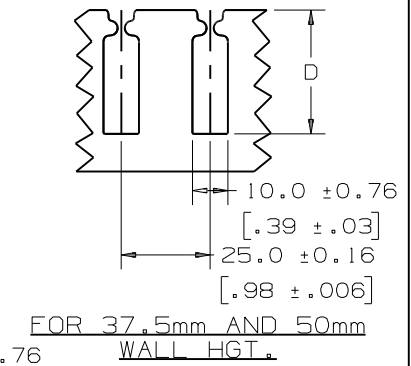
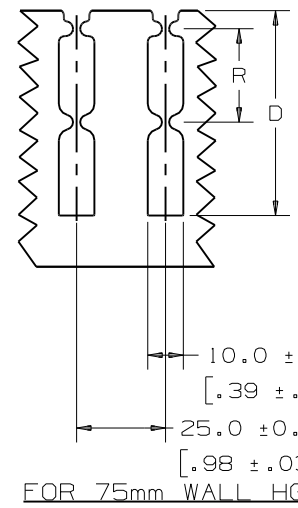
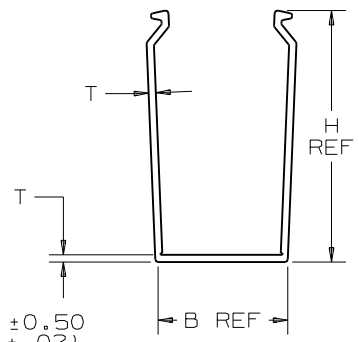

CHANNEL EXAMPLE:
 NNC 37 X 50 LG 2
 TYPE 37mm WIDE 50mm HIGH COLOR (LIGHT GRAY) LENGTH (m)

- B**
- NOTES:
 1. "B" MEASURED AT BASE.
 2. STANDARD LENGTH: 2 METER.
 3. SEE CURRENT CATALOG FOR PART NUMBER DESIGNATIONS FOR TYPE, COLOR, AND LENGTH.
 4. DUCT TYPE "NNC" PACKAGED WITH TYPE "NC" COVER.
 5. DIMENSIONS ARE METRIC (INCHES).

CAD FILENAME/LAYERS		D38539AA_DC_NNC_01B.PRT	
<h1>PANDUIT</h1> CORP. TINLEY PARK, ILLINOIS WIRING DUCT AND COVER TYPE "NNC" METRIC CUSTOMER DRAWING			
UNLESS OTHERWISE SPECIFIED, DIMENSIONAL TOLERANCES ARE:		UNLESS OTHERWISE SPECIFIED, ALL DIMENSIONS ARE GIVEN IN INCHES, THIRD ANGLE PROJECTION.	
(.X) ± .1 (.XX) ± 0.1		(.XXX) ± .05 ANGLES ±	
I 9-18-06 JCST JKG R 11-2-02 JHNU JCST JKG REV DATE BY CHK DESCRIPTION ECN - R CUST SUP	B. CHANGED NOTES A. ADDED NEW SIZES	38539-04 JKG JKG 38539-04 HIW HIW	DRAWN BY JHNU DATE 8-2-02 CHK'D JKG
F. CHANGED TOLERANCE E. REMOVED THE ".5"		D. RE-ORDERED CHART (WAS SORTED BY "H") C. CHANGED DIMENSION TO REF. DIMENSION	
MAT'L: HALOGEN FREE MODIFIED POLYPHENYLENE OXIDE (PPO)		SCALE NONE DRAWING NO. 38539-04 Sht 1 of 3 DWG A SIZE	

THIS COPY IS PROVIDED ON A RESTRICTED BASIS AND IS NOT TO BE USED IN ANY WAY DETRIMENTAL TO THE INTERESTS OF PANDUIT CORP.



PROFILE DIMENSION				
NOMINAL DUCT SIZE (W X H)	B REF	H REF	T	T TOL.
25 X 25	24.6 (.97)	20.5 (.81)	1.4 (.06)	±.26 (.010)
25 X 37	24.6 (.97)	33.0 (1.30)	1.4 (.06)	±.26 (.010)
25 X 50	24.6 (.97)	45.5 (1.79)	2.0 (.08)	±.30 (.012)
25 X 75	24.6 (.97)	70.5 (2.78)	1.7 (.07)	±.30 (.012)
37 X 37	37.1 (1.46)	33.0 (1.30)	1.8 (.07)	±.30 (.012)
37 X 50	37.1 (1.46)	45.5 (1.79)	2.0 (.08)	±.30 (.012)
37 X 75	37.1 (1.46)	70.5 (2.78)	2.0 (.08)	±.36 (.014)
50 X 50	49.6 (1.95)	45.5 (1.79)	2.0 (.08)	±.30 (.012)
50 X 75	49.6 (1.95)	70.5 (2.78)	2.0 (.08)	±.36 (.014)
50 X 100	49.6 (1.95)	95.5 (3.76)	2.2 (.09)	±.40 (.016)
75 X 75	74.6 (2.94)	70.5 (2.78)	2.0 (.08)	±.40 (.016)
100 X 50	99.6 (3.92)	45.5 (1.79)	2.0 (.08)	±.40 (.016)
100 X 75	98.6 (3.92)	70.5 (2.78)	2.5 (.10)	±.50 (.020)
100 X 100	99.6 (3.92)	95.5 (3.76)	2.5 (.10)	±.50 (.020)



MOUNTING HOLE	
NOMINAL DUCT WIDTH	K
±.5 (.02)	
25	----
37	----
50	----
75	25.0 (.98)
100	25.0 (.98)



SLOT DIMENSION		
NOMINAL DUCT HEIGHT	D	R
±.8 (.03)		±.75 (.02)
25	13.6 (.54)	-----
37	24.7 (.97)	-----
50	34.8 (1.37)	-----
75	57.6 (2.27)	26.26 (1.03)
100	81.0 (3.19)	38.0 (1.50)

ALL DIMENSIONS ARE METRIC (INCHES)

CAD FILENAME/LAYERS D38539AA_DC_NNC_01B.PRT

PANDUIT CORP. TINLEY PARK, ILLINOIS

WIRING DUCT AND COVER
TYPE "NNC" METRIC
CUSTOMER DRAWING

UNLESS OTHERWISE SPECIFIED,
DIMENSIONAL TOLERANCES ARE:
(.X) ± (.XXX) ±
(.XX) ± 3.1 (.12) ANGLES ±

UNLESS OTHERWISE SPECIFIED,
ALL DIMENSIONS ARE GIVEN
IN INCHES, THIRD ANGLE PROJECTION.

REV	DATE	BY	CHK	DESCRIPTION	ECN	CHK	CUST	SUP
I	9-18-06	JCST	JKG	SEE SHEET 1 OF 3 FOR REVISIONS	38539-04	JKG	JKG	
R	11-2-02	JHNU JCST	JKG	SEE SHEET 1 OF 3 FOR REVISIONS	38539-04	HIW	HIW	

DRAWN BY JHNU
DATE 8-2-02
CHK'D JKG

MAT'L: HALOGEN FREE
MODIFIED
POLYPHENYLENE
OXIDE
(PPO)

SCALE NONE
DRAWING NO. 38539-04
SHT 2 OF 3
DWG SIZE A



THIS COPY IS PROVIDED ON A RESTRICTED BASIS AND IS NOT TO BE USED IN ANY WAY DETRIMENTAL TO THE INTERESTS OF PANDUIT CORP.

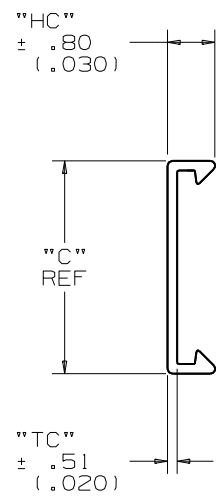

NOMINAL DUCT SIZE (W)	C REF	HC	TC
25	24.6 (.97)	8.9 (.35)	1.30 (.05)
37	37.1 (1.46)	8.9 (.35)	1.30 (.05)
50	49.6 (1.95)	8.9 (.35)	1.40 (.06)
75	74.6 (2.94)	9.4 (.37)	1.40 (.06)
100	99.6 (3.92)	9.4 (.37)	1.40 (.06)

ALL DIMENSIONS ARE METRIC (INCHES)

CAD FILENAME/LAYERS D38539AA_DC_NNC_01B

REV	DATE	BY	CHK	DESCRIPTION	ECN	R	CUST	SUP
I	9-18-06	JCST	JKG	SEE SHEET 1 OF 3 FOR REVISIONS	38539-04	JKG	JKG	
R	11-2-02	JHNU JCST	JKG	SEE SHEET 1 OF 3 FOR REVISIONS	38539-04	HIW	HIW	

PANDUIT CORP TINLEY PARK, ILLINOIS
WIRING DUCT AND COVER
TYPE "NNC" METRIC
CUSTOMER DRAWING

UNLESS OTHERWISE SPECIFIED, DIMENSIONAL TOLERANCES ARE: (.X) ± .01 (.XX) ± .01		UNLESS OTHERWISE SPECIFIED, ALL DIMENSIONS ARE GIVEN IN INCHES, THIRD ANGLE PROJECTION.	
DRAWN BY JHNU	MAT'L: HALOGEN FREE MODIFIED POLYPHENYLENE OXIDE (PPO)	SCALE NONE	
DATE 8-2-02		DRAWING NO. 38539-04	DWG A
CHK'D JKG		SHT 3 OF 3	SIZE

