

### INSTRUCTIONS CM458

© Panduit Corp. 2010

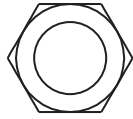

3/8" Nut

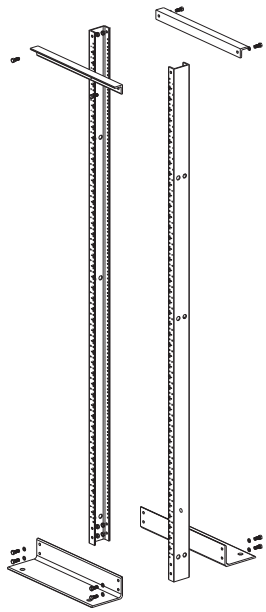
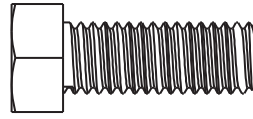

3-8X1" Bolt

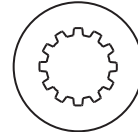

3/8" Paint Piercing Washer

#### RACK ASSEMBLY

Apply Antioxidant Paste to painted surfaces that the 3/8" paint piercing washers will come in contact with. Install top angles to upright channels using (2) 3/8x1" bolts (2) 3/8" nuts and (4) 3/8" paint piercing washer (see figure below) per angle. **Finger tighten only.**

Apply Antioxidant Paste to painted surfaces that the 3/8" paint piercing washers will come in contact with. Install the base angles to the vertical upright channels using (4) 3/8x1" bolts (4) 3/8" nuts and (8) 3-16 paint piercing washers (see figure below) per angle. **Finger tighten only.**

Stand rack upright. Square the upright channels with the base using a carpenter square. **Completely tighten all bolts to at least 14 ft.-lbs(19.0 N-m).**

#### Mounting Configuration

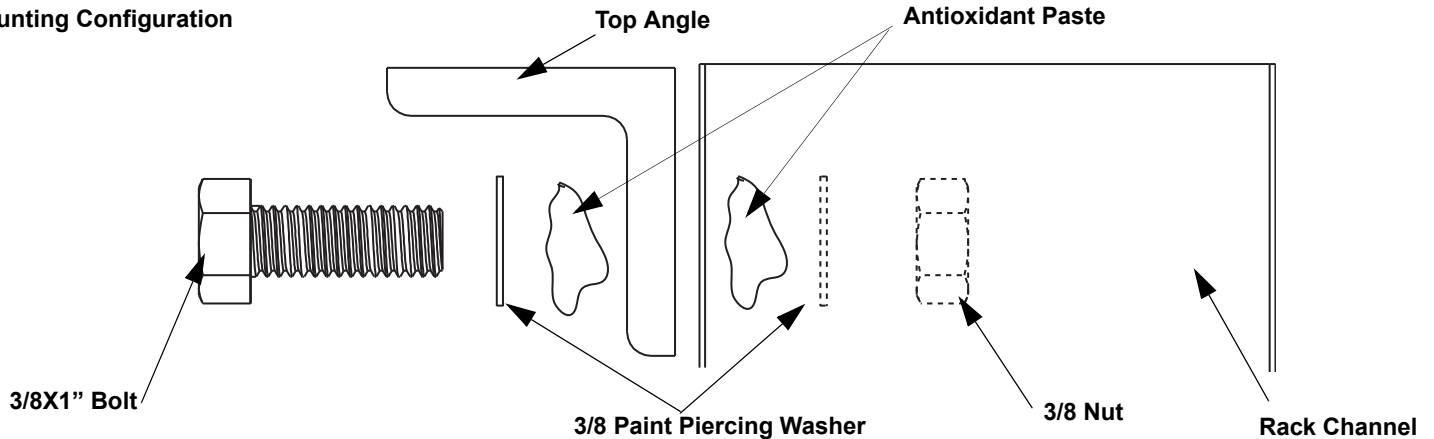

#### MOUNT RACK TO FLOOR

Securely mount the rack to the floor using the appropriate hardware based on the floor construction (concrete, raised floor, or wood). **Note:** Mounting using the holes closest to the rack will minimize deflection.

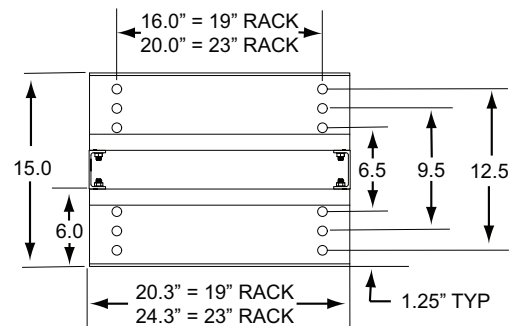
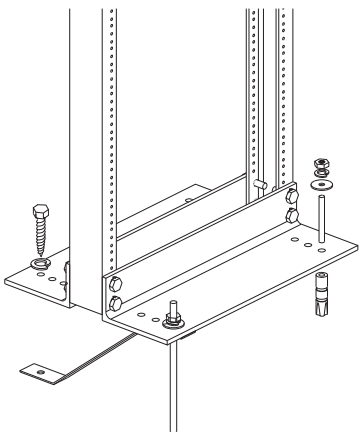

**Note:** The maximum weight load of the rack is 1,000 pounds with the exception of the R2P48, which is 300 lbs. The weight should be evenly distributed across the height of the rack, with the heaviest components mounted at the bottom of the rack. The top angles are not intended to support a significant load.