

# Pan-Way® Surface Raceway



**PANDUIT®**

building a smarter,  
unified business foundation

Connect. Manage. Automate.

## Surface Raceway Applications

Facility and IT network teams are being challenged to build up or remodel their enterprise buildings. Surface raceway products provide maximum flexibility for routing, protecting, and concealing high-performance copper, voice, video, fiber optic, and electrical wiring within any enterprise environment to:

- Provide an innovative and satisfying office environment
- Maintain the vision to allow for future business growth
- Enable new smart devices
- Conserve limited resources



### Education

Surface mount raceway can be found inside educational facilities; such as classrooms, laboratories, libraries, auditoriums, dorm rooms, and administrative offices.



### Government/Military

Government buildings, as well as state and local municipalities, utilize raceway in administrative offices and open work areas. Military installations, such as U.S. Air Force bases, utilize raceway throughout their locations.



### Healthcare

Healthcare offices including facilities, individual workstations, laboratories, and patient care areas employ raceway.

## Features and Benefits of Pan-Way® Surface Raceway



- Durable PVC construction
- Lightweight
- Easy to transport
- Simple one-person installation
- Reduces overall installer fatigue



- Will not chip, rust, or corrode
- No special tools required for cutting
- Can be cut with standard saws and blades
- No sharp burrs or rough edges to file



- RoHS compliant
- UL94V-0 flammability rating
- Meets applicable international, UL, and customer standards
- Fittings maintain TIA/EIA bend radius control



- Provides power, data, or both in the same raceway
- Large output of power and/or data access points
- Tamper resistant
- Wide range of sizes and profiles

## Unique Features of Pan-Way® Surface Raceway

### Pan-Way® Fast-Snap™/Snap-On Technology

Pan-Way® Fast-Snap™ Surface Mount Boxes assemble without the use of screws or additional hardware and can accommodate both power and communication applications. Fast-Snap™ Boxes can accept any standard NEMA 70mm screw-on faceplate. Pan-Way® Snap-On Faceplates attach directly to Fast-Snap™ Boxes, any 70mm raceway, Cove, or Pan-Pole™ device without the use of screws or additional hardware.

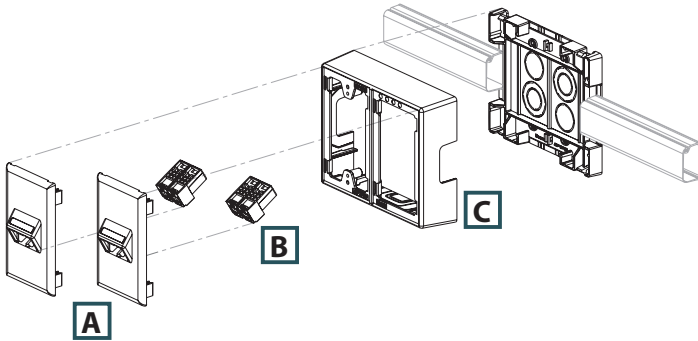

#### Components Required

A	Snap-on vertical sloped communication faceplate – 2-port (T70FV2)
B	Mini-Com® Modules
C	Fast-Snap™ Double Gang power rated (JBP2FS)

### Unique 70mm Raceway (T-70, Twin-70, and TG-70)

70mm channel opening allows multiple inline access points for space optimization and aesthetic installation, while supporting Pan-Way® Snap-On Faceplates. This unique raceway also supports any NEMA standard screw-on faceplate with use of device bracket and can reduce to smaller profile raceway (T-45 or LD raceway).

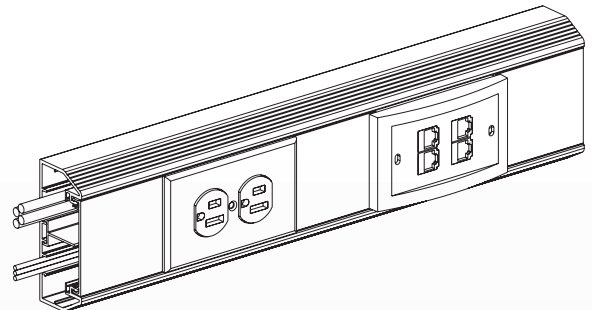

### Modular Divider Wall (T-70, Twin-70, TG-70, and T-45)

This modular divider wall allows channel configuration flexibility.

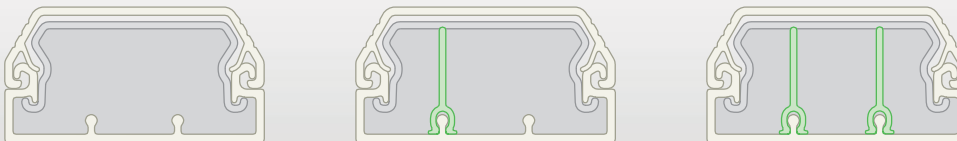

### Aesthetically Pleasing Design

T-70, Twin-70, TG-70 and T-45 is designed with a beveled profile to help blend in to existing décor. Cove raceway is designed to resemble crown molding.





## T-70 Profile Raceway

- Two-piece design
- Multi channel (with divider wall)

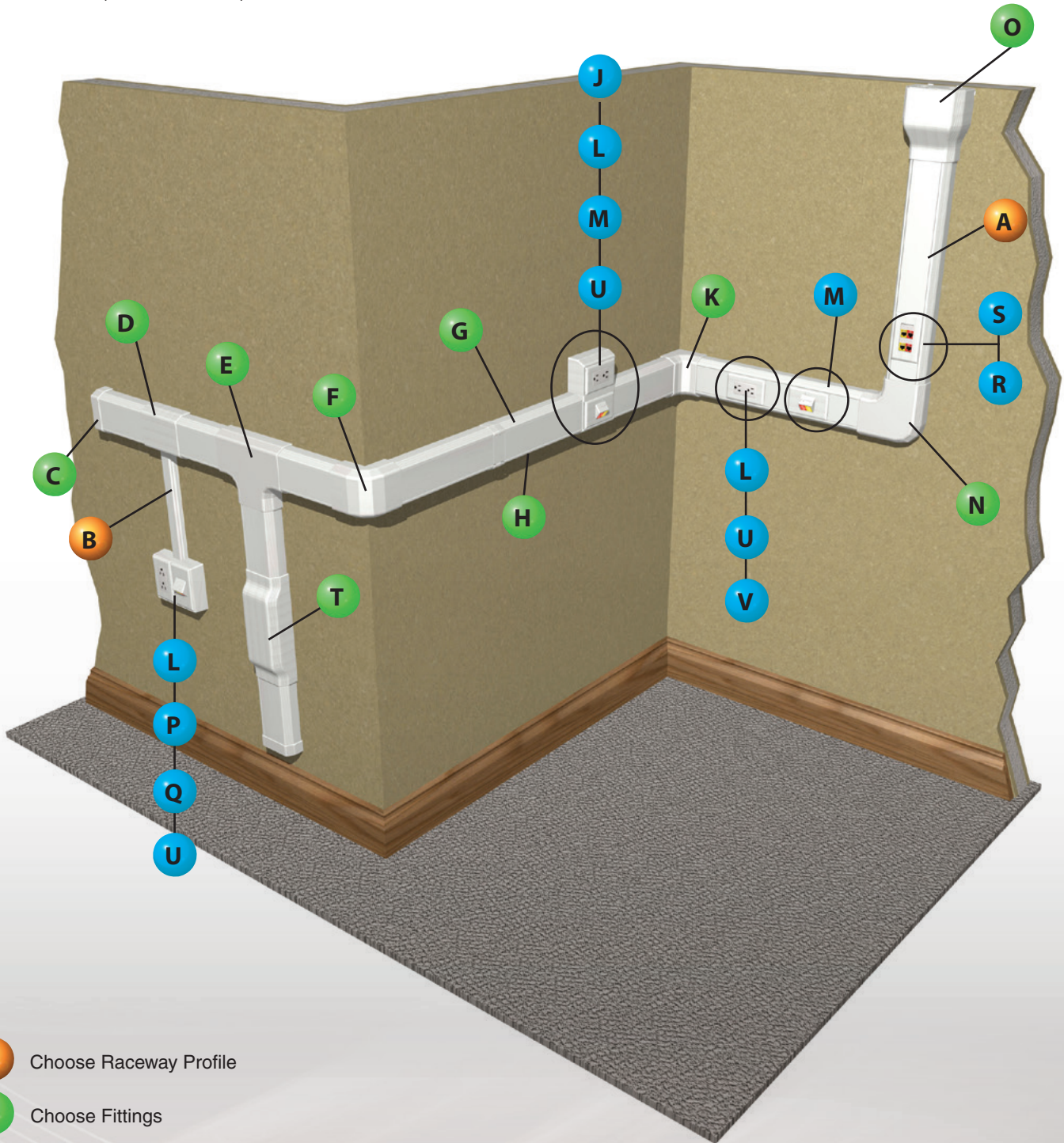

- 1 Choose Raceway Profile
- 2 Choose Fittings
- 3 Choose Accessories

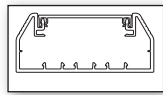

**A** T-70 Base and Cover (T70B\*\*, T70C\*\*)

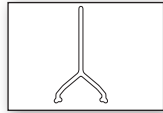

**A** T-70 Divider Wall (T70DW)

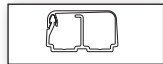

**B** LD2P10 Raceway (LD2P10\*\*)

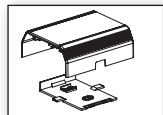
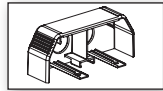

**E** T-70 Tee Fitting (T70T\*\*)

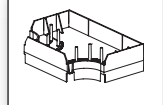

T-70 Tee Divider (T70TD)

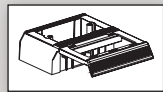
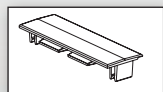
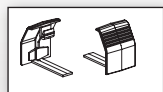
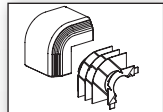

**J** T-70 Workstation Outlet Center™ Offset Box for Snap-On Faceplates (T70WC2\*\*)

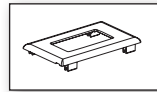
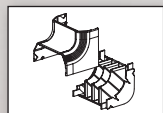

**L** Single Gang Rectangular Electrical/ Communication Snap-On Faceplate (T70PG\*\*)

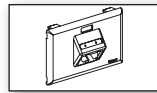

**M** Ultimate ID® Sloped Horizontal Snap-On Faceplate (UIT70FH2\*\*)

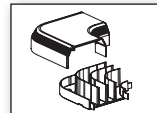

**N** T-70 Right Angle Fitting (T70RA\*\*)

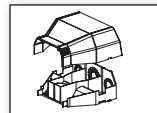

**O** T-70 Entrance End Fitting (T70EE\*\*)

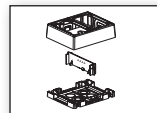

**P** Fast-Snap™ Double Gang Power Rated Surface Mount Outlet Box (JBP2FS\*\*)

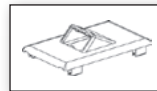

**Q** Vertical Sloped Communication Snap-On Faceplate (T70FV2\*\*)

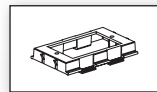

**R** T-70 Device Bracket (T70DB-X)

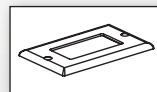

**S** Single Gang Rectangular Screw-On Faceplate (CPG\*\*)

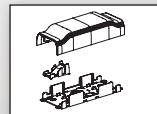

**T** T-70 Backfeed Fitting (T70BF\*\*)

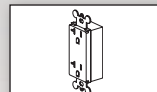

**U** 20 A Rectangular Electrical Outlet (ERU20\*\*)

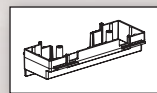

**V** 3-Sided Hanging Box (T70HB3-X)





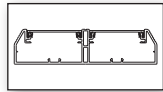

**A** Twin-70 Raceway Base and Cover (T702B\*\*, T70C\*\*)

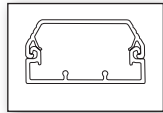

**B** T-45 Raceway Base and Cover (T45B\*\*, T45C\*\*)

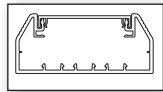

**C** T-70 Raceway Base and Cover (T70B\*\*, T70C\*\*)

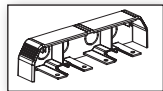

**D** Twin-70 End Cap Fitting (T702EC\*\*)

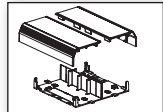

**E** Twin-70 Transition Fitting (T702TRL\*\*)

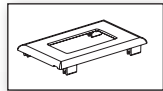

**F** Single Gang Rectangular Electrical/Communication Snap-On Faceplate (T70PG\*\*)

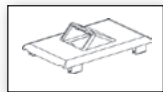

**G** Vertical Sloped Communication Snap-On Faceplate (T70FV2\*\*)

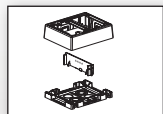

**H** Fast-Snap™ Double Gang Power Rated Surface Mount Outlet Box (JBP2FS\*\*)

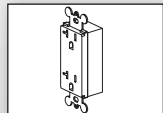

**J** 20 A Rectangular Electrical Outlet (ERU20\*\*)

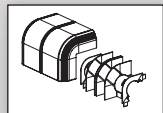

**K** Twin-70 Outside Corner Fitting (T702OC\*\*)

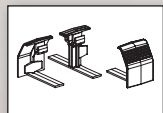

**L** Twin-70 Base Coupler Fitting (T702BC\*\*)

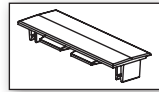

**M** T-70 Cover Coupler Fitting (T70CC\*\*)

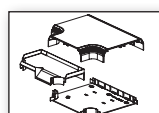

**N** Twin-70 Tee Fitting (T702T\*\*)



**O** Twin-70 Inside Corner Fitting (T702IC\*\*)



**P** Twin-70 Transition Fitting (T702TR\*\*)

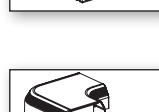

**Q** T-70 Right Angle Fitting (T70RA\*\*)



**R** T-70 End Cap Fitting (T70EC\*\*)



**S** Ultimate ID® Sloped Horizontal Snap-On Faceplate (UIT70FH4\*\*)

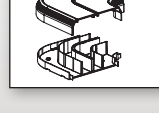

**T** Twin-70 Right Angle Fitting (T702RA\*\*)

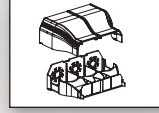

**U** Twin-70 Entrance End Fitting (T702EE\*\*)

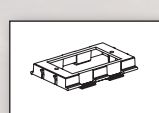

**V** T-70 Device Mounting Bracket (T70DB-X\*\*)



## TG-70 Profile Raceway

- Two-piece design
- Multi channel (with divider wall)
- X-Large internal area

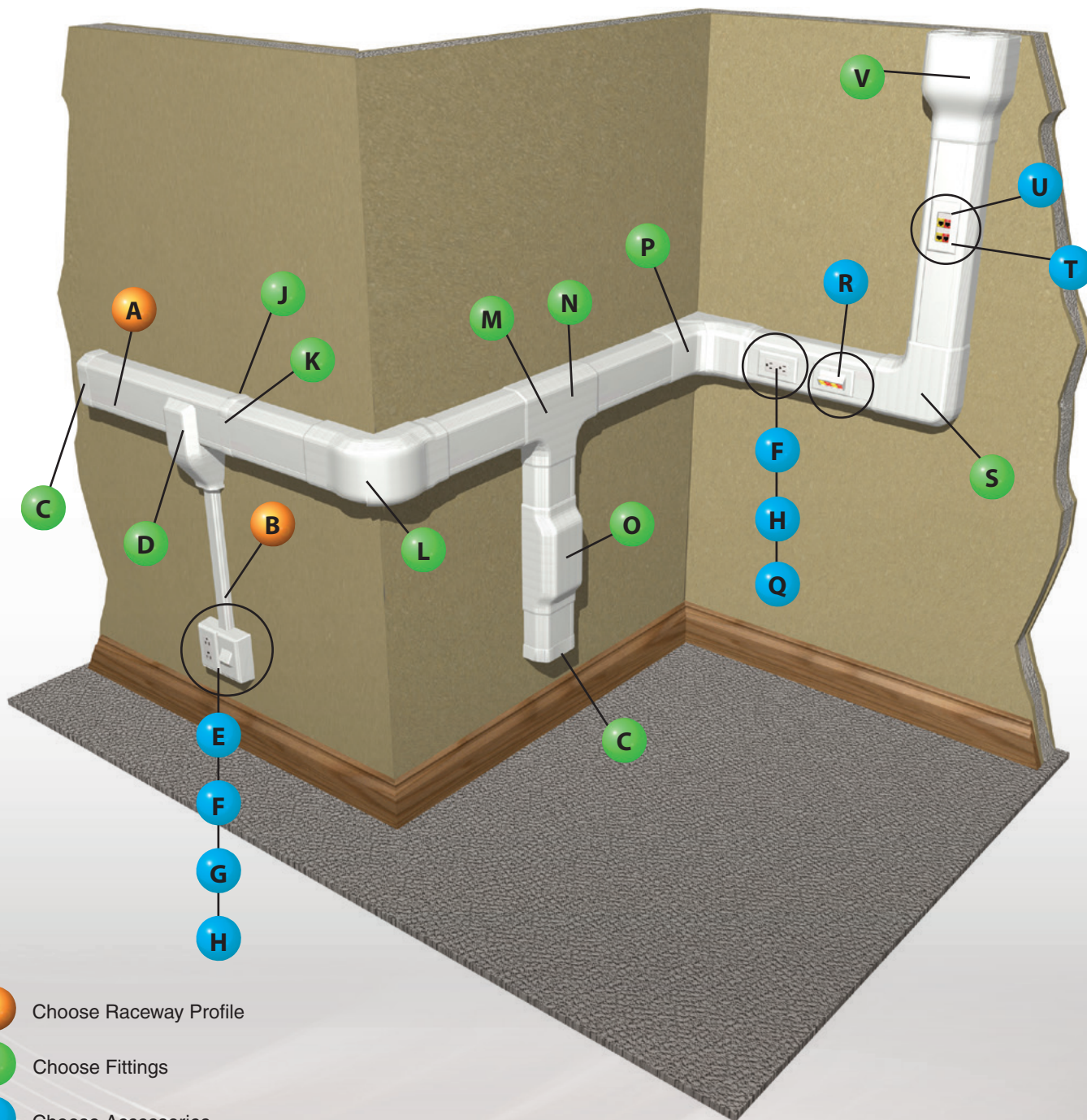

- 1 Choose Raceway Profile
- 2 Choose Fittings
- 3 Choose Accessories



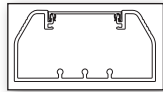

**A** TG-70 Raceway Base and Cover (TG-70\*\*)

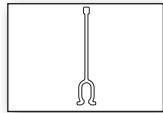

**A** TG-70 Raceway Divider Wall (TGDW)



**B** Raceway (LD2P10\*\*)

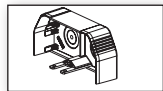

**C** TG-70 End Cap (TSEC\*\*)

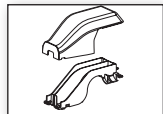

**D** TG-70 Transition Fitting (TGTR\*\*)

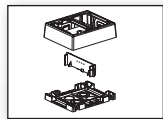

**E** Fast-Snap™ Double Gang Power Rated Surface Mount Box (JBP2FS\*\*)

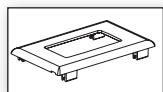

**F** Single Gang Rectangular Electrical/Communication Snap-On Faceplate (T70PG\*\*)



**G** Vertical Sloped Communication Snap-On Faceplate (T70FV2\*\*)

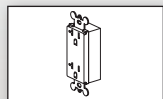

**H** 20 A Rectangular Electrical Outlet (ERU20\*\*)

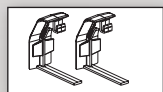

**J** TG-70 Base Couplers (TG70BC\*\*)

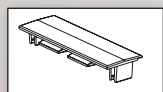

**K** T-70 Cover Couplers (T70CC\*\*)

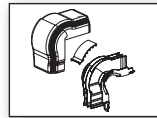

**L** TG-70 Outside Corner Fitting (TGOC\*\*)



**M** TG-70 Tee Fitting (TGT\*\*)

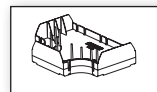

**N** TG Tee Divider (TGTD)

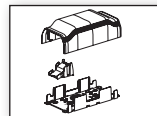

**O** TG-70 Backfeed Fitting (TGBF\*\*)



**P** TG-70 Inside Corner Fitting (TGIC\*\*)

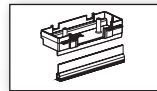

**Q** TG-70 Hanging Box with Divider Wall (TG70HB3-X)

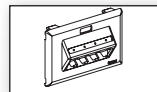

**R** Ultimate ID® Sloped Horizontal Snap-On Faceplate (UIT70FH4\*\*)

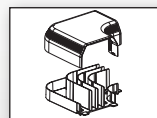

**S** TG-70 Right Angle Fitting (TGRA\*\*)

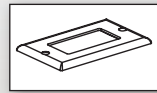

**T** Single Gang Rectangular Power and Communication Faceplate (CPG\*\*)

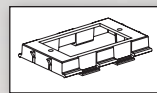

**U** T-70 Device Mounting Bracket (T70DB-X)



**V** TG-70 Entrance End Fitting (TGEE\*\*)

## T-45 Profile Raceway

- Two-piece, hinged design
- Multi channel (with divider wall)

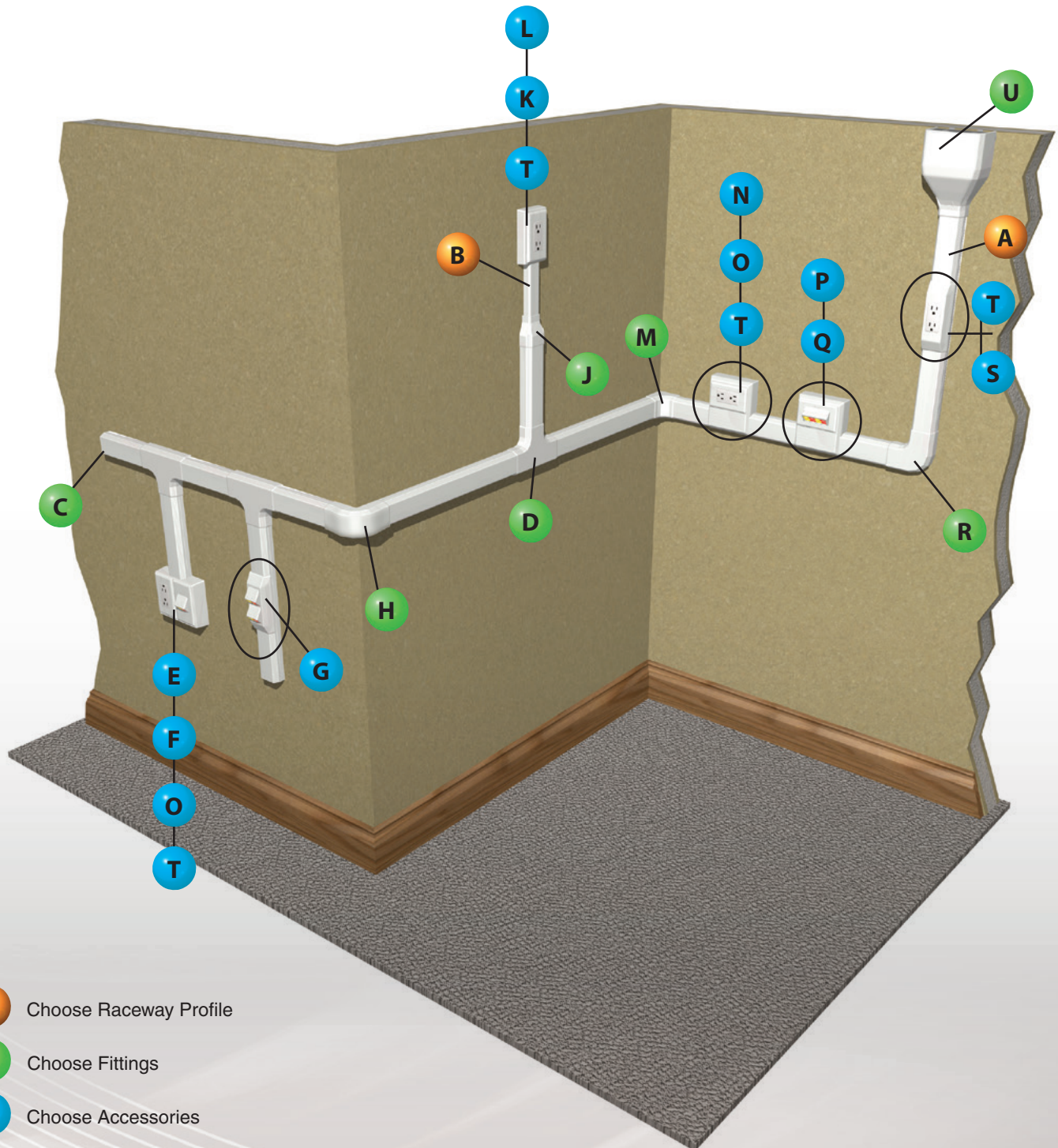

- 1 Choose Raceway Profile
- 2 Choose Fittings
- 3 Choose Accessories



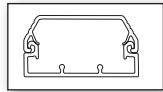

**A** T-45 Raceway Base and Cover (T45B\*\*, T45C\*\*)

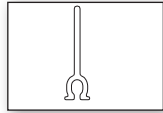

**A** T-45 Divider Wall (T45DW\*\*)

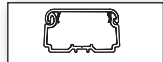

**B** LDPH Raceway (LDPH10\*\*)



**C** T-45 End Cap Fitting (T45EC\*\*)



**D** T-45 Tee Fitting and Divider (T45T\*\* and T45TD)

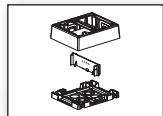

**E** Fast-Snap™ Double Gang Power Rated Surface Mount Outlet Box (JBP2FS\*\*)

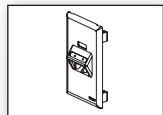

**F** Ultimate ID® Sloped Vertical Snap-On Faceplate (UIT70FV2\*\*)

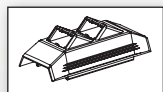

**G** T-45 Snap-On Hinged Data Bracket (T45HDB\*\*)

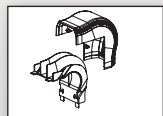

**H** T-45 Outside Corner Fitting (T45OC\*\*)

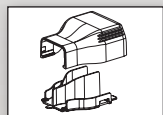

**J** T-45 Reducer Fitting (T45RLD\*\*)

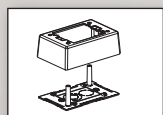

**K** Power Rated Single Gang Two-Piece Box (JBP1\*\*)

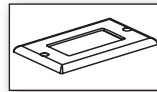

**L** Single Gang Rectangular Electrical/Communication Screw-On Faceplate (CPG\*\*)

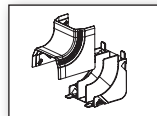

**M** T-45 Inside Corner Fitting (T45IC\*\*)

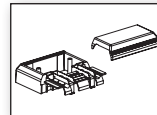

**N** T-45 Offset Box for Screw-On Faceplates/Receptacles (T45WC\*\*)

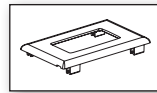

**O** Single Gang Rectangular Electrical/Communication Snap-On Faceplate (T70PG\*\*)

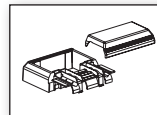

**P** T-45 Offset Box for Snap-On Faceplates (T45WC2\*\*)



**Q** Ultimate ID® Sloped Horizontal Snap-On Faceplate (UIT70FH4\*\*)

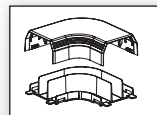

**R** T-45 Right Angle Fitting (T45RA\*\*)

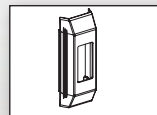

**S** T-45 Electrical Bracket (T45HEGB\*\*)

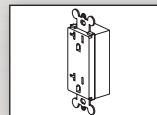

**T** 20 A Rectangular Electrical Outlet (ERU20\*\*)

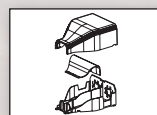

**U** T-45 Entrance End Fitting (T45EE\*\*)

## LD Profile Raceway

- One-piece, hinged design
- Single channel

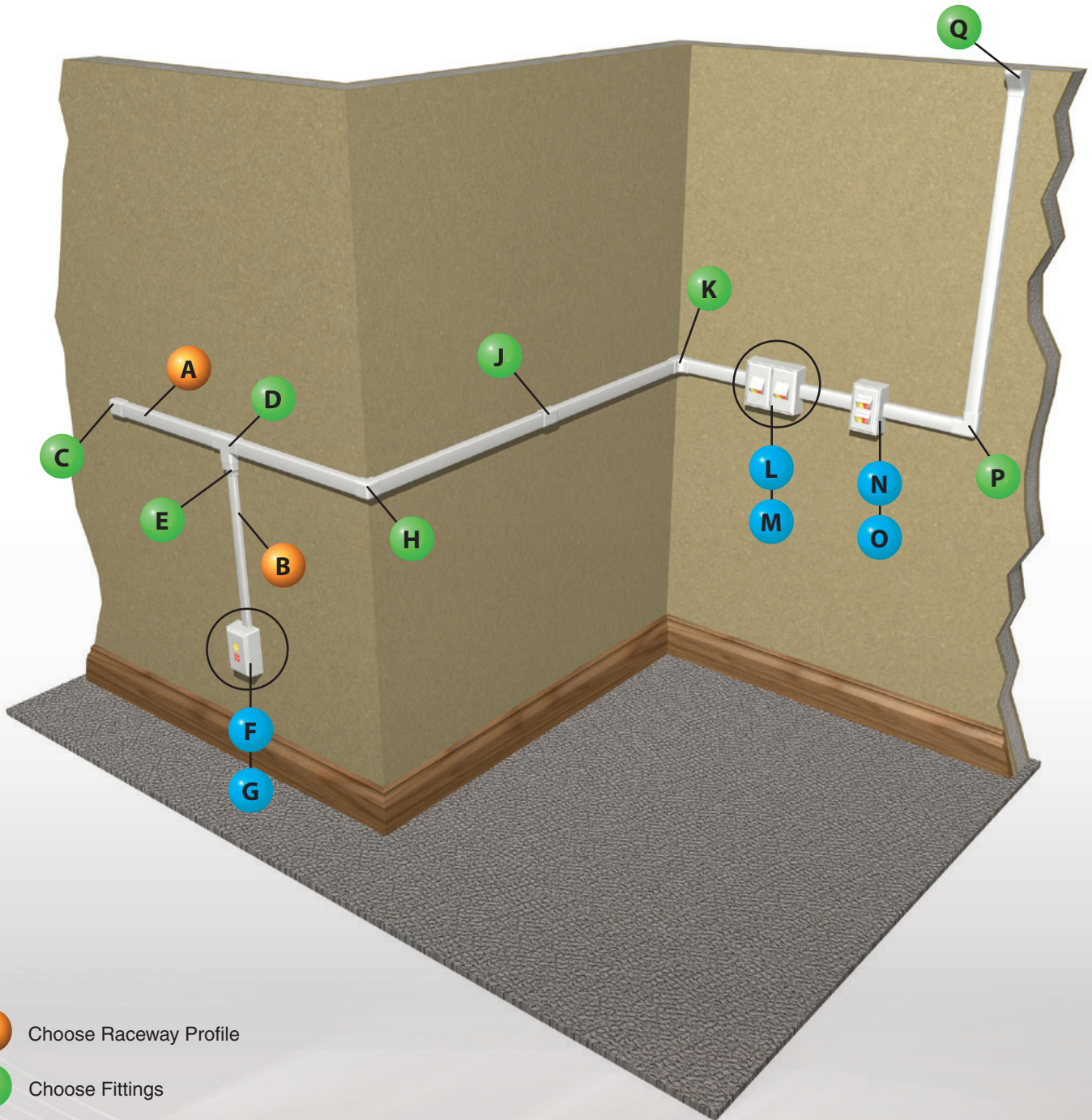

**1** Choose Raceway Profile

**2** Choose Fittings

**3** Choose Accessories



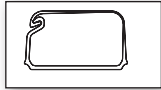

**A** Raceway (LD10\*\*)

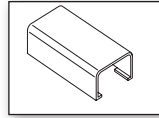

**J** Coupler Fitting (CF10\*\*)

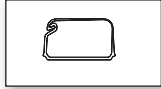

**B** Raceway (LD5\*\*)

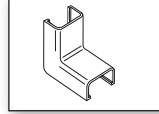

**K** Inside Corner Fitting (ICF10\*\*)

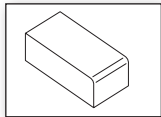

**C** End Cap Fitting (ECF10\*\*)

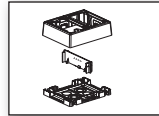

**L** Fast-Snap™ Double Gang Power Rated Surface Mount Outlet Box (JBP2FS\*\*)

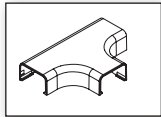

**D** Tee Fitting (TF10\*\*)

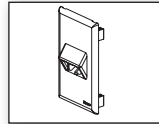

**M** Snap-On Vertical Sloped Communication Faceplate (T70FV2\*\*)

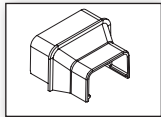

**E** Reducer Fitting (RF10X5\*\*)

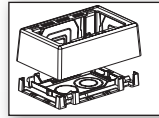

**N** Fast-Snap™ Single Gang Surface Mount Outlet Box (JB1FS\*\*)

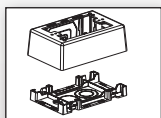

**F** Single Gang Two-Piece Snap-Together Box (JBX3510\*\*)

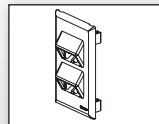

**O** Snap-On Vertical Sloped Communication Faceplate (T70FV4\*\*)

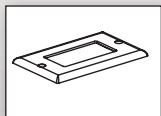

**G** Single Gang Rectangular Screw-On Faceplate (CPG\*\*)

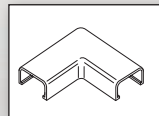

**P** Right Angle Fitting (RAF10\*\*)

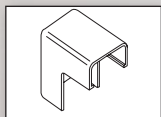

**H** Outside Corner Fitting (OCF10\*\*)

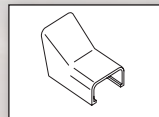

**Q** Drop Ceiling/Entrance End Fitting (DCF10\*\*)

## LDPH Profile Raceway

- Two-piece, hinged design
- Single channel
- Power rated

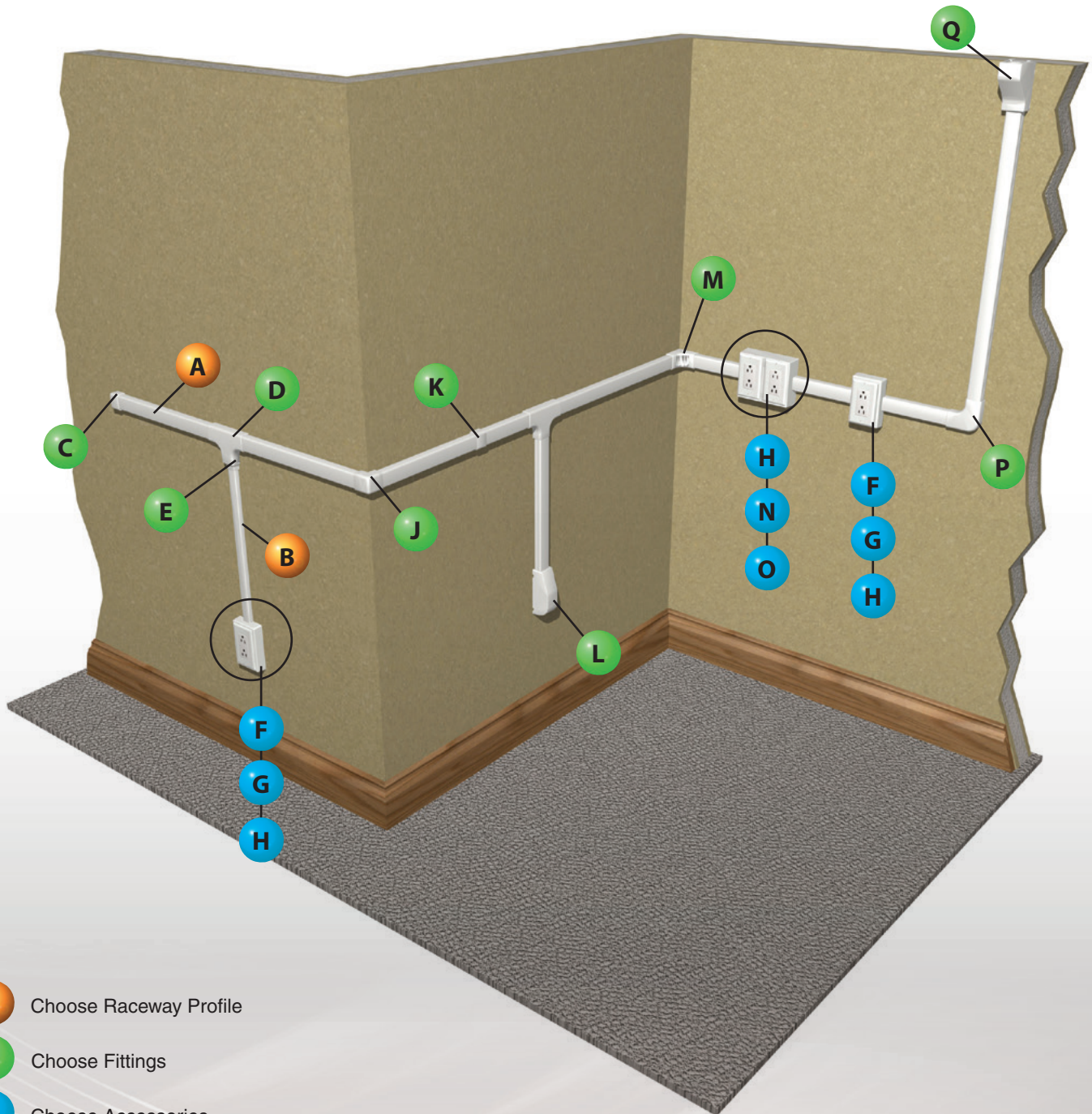

- 1 Choose Raceway Profile
- 2 Choose Fittings
- 3 Choose Accessories



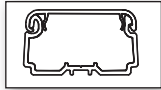

**A** Raceway (LDPH10\*\*)

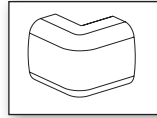

**J** Power Rated Outside Corner Fitting (OCFC10\*\*)

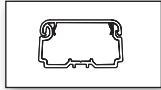

**B** Raceway (LDPH5\*\*)

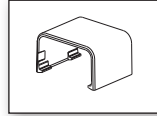

**K** Power Rated/1 Inch Bend Radius Coupler Fitting (CFX10\*\*)

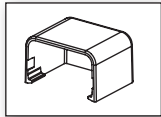

**C** Power Rated/1 Inch Bend Radius End Cap Fitting (ECFX10\*\*)

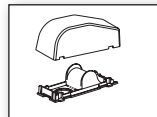

**L** Power Rated/1 Inch Bend Radius Right Angle Entrance End Fitting (RAEFX\*\*)

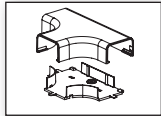

**D** Power Rated Tee Fitting (TFX10\*\*)

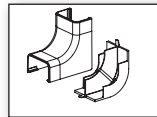

**M** Power Rated Inside Corner Fitting (ICFX10\*\*)

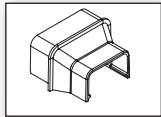

**E** Power Rated/1 Inch Bend Radius Reducer Fitting (RFX105\*\*)

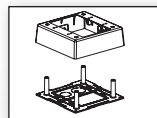

**N** Power Rated Double Gang Two-Piece Box (JBP2\*\*)

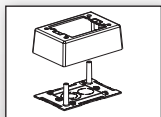

**F** Power Rated Single Gang Two-Piece Box (JBP1\*\*)

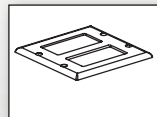

**O** Double Gang Rectangular Screw-On Faceplates (CPG\*\*-2G)

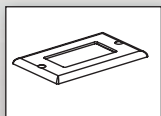

**G** Single Gang Rectangular Screw-On Faceplate (CPG\*\*)

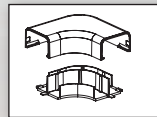

**P** Power Rated Right Angle Fitting (RAFX10\*\*)

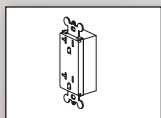

**H** 20 A Rectangular Electrical Outlet (ERU20\*\*)

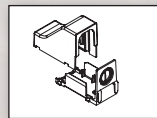

**Q** Power Rated/1 Inch Bend Radius Drop Ceiling Entrance End Fitting (DCEFX\*\*)

## LD2P10 Profile Raceway

- One-piece, hinged design
- Dual channel

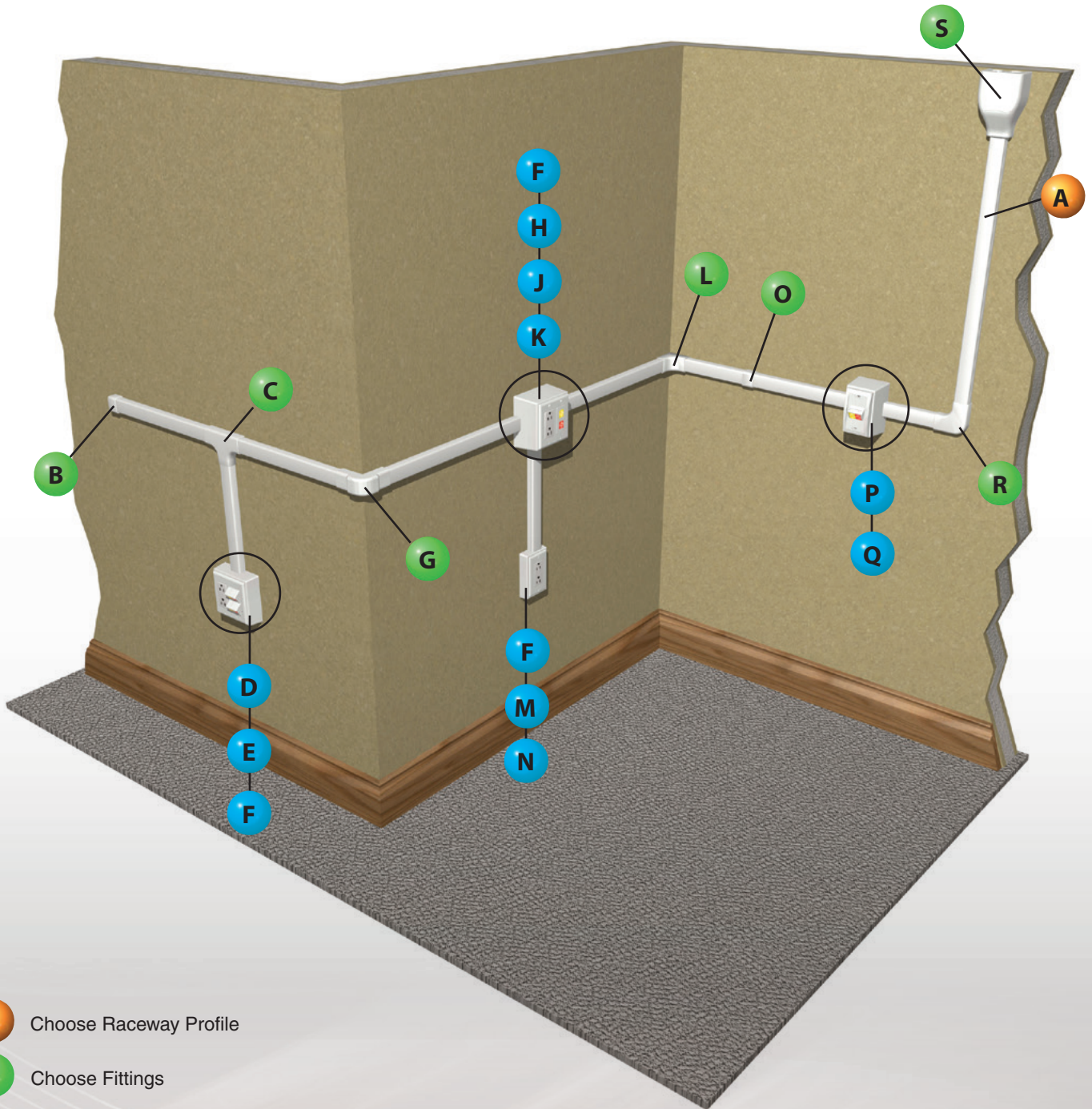

- 1 Choose Raceway Profile
- 2 Choose Fittings
- 3 Choose Accessories



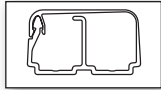

**A** Raceway (LD2P10\*\*)

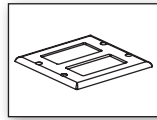

**K** Double Gang Rectangular Screw-On Faceplate (CPG\*\*-2G)

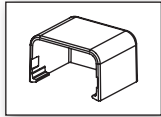

**B** Power Rated End Cap Fitting (ECFX10\*\*)

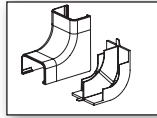

**L** Power Rated Inside Corner Fitting (ICFX10\*\*)

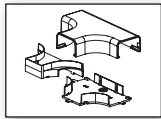

**C** 1 Inch Bend Radius Tee Fitting (TFXD10\*\*)

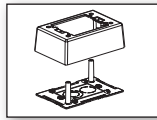

**M** Power Rated Single Gang Two-Piece Box (JBP1\*\*)

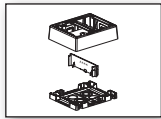

**D** Power Rated Double Gang Two-Piece Divided Box (JBP2S\*\*)

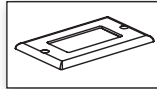

**N** Single Gang Rectangular Screw-On Faceplate (CPG\*\*)

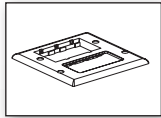

**E** Double Gang Rectangular Electrical and Two Communication Insert Faceplate (FP2RC\*\*)

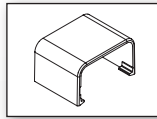

**O** Power Rated Coupler Fitting (CFX10\*\*)

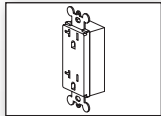

**F** 20 A Rectangular Electrical Outlet (ERU20\*\*)

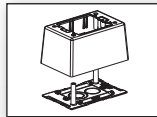

**P** Single Gang Two-Piece Deep Box (JBP1D\*\*)

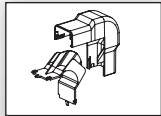

**G** 1 Inch Bend Radius Outside Corner Fitting (OCFX10\*\*)

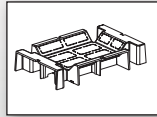

**Q** Single Gang Pass Through Divider for LD2P10 Raceway (JBD1)

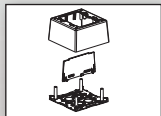

**H** Power Rated Double Gang Two-Piece Deep Box (JBP2D\*\*)

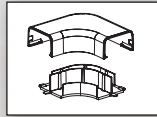

**R** Power Rated Right Angle Fitting (RAFX10\*\*)

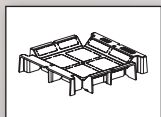

**J** JBD2 – Double Gang Pass Through and Divider for LD2P10 Raceway

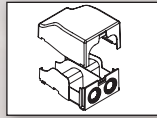

**S** Power Rated/1 Inch Bend Radius Entrance End Fitting (EEFX\*\*)

## Cove Raceway

- Two-piece design
- Multi channel (with divider wall)
- Designed for corner applications

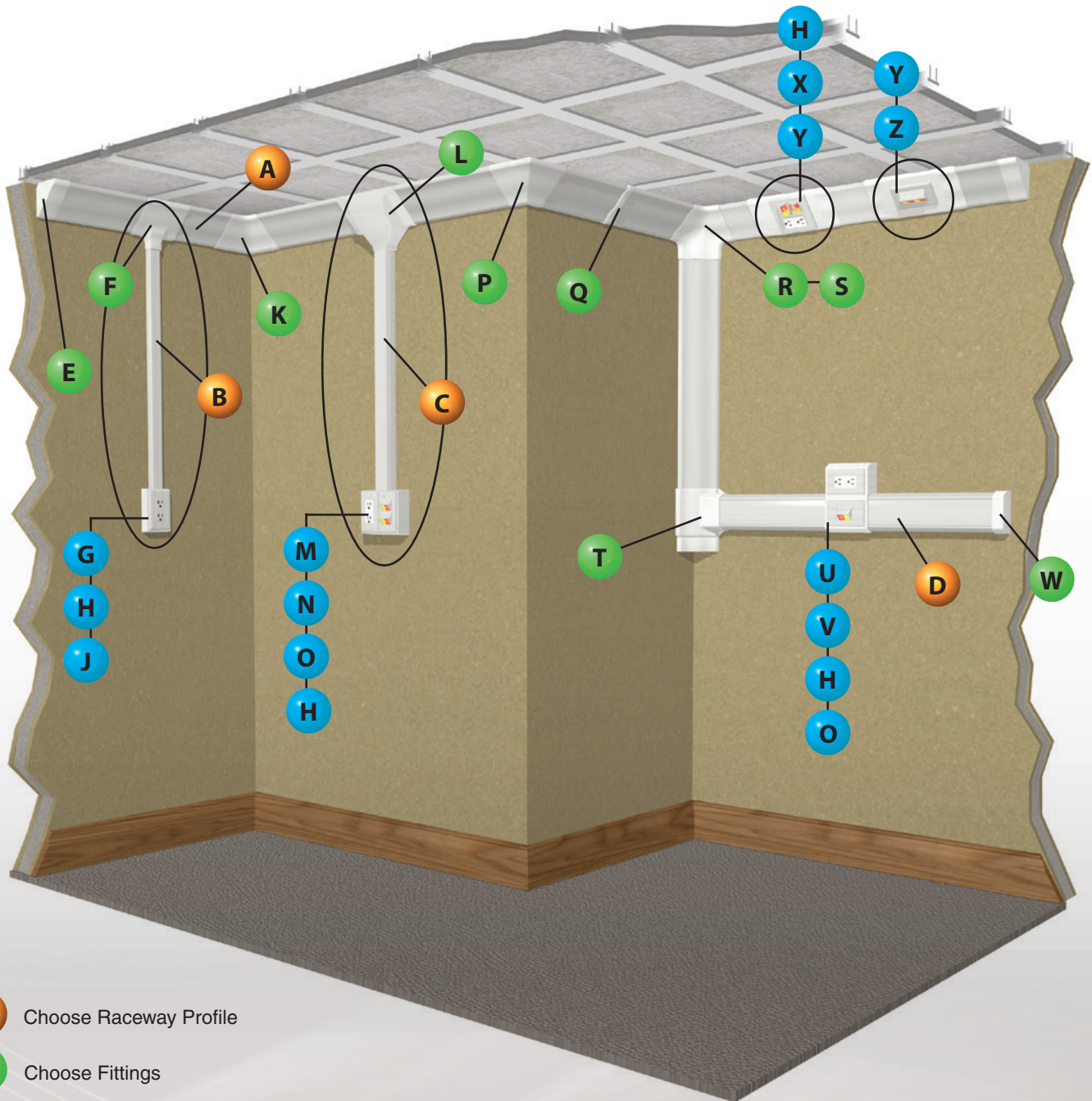

- 1 Choose Raceway Profile
- 2 Choose Fittings
- 3 Choose Accessories



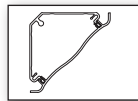

**A** Cove Raceway Base and Cover (WCM35BIW, WCM35CIW)

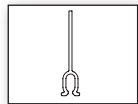

**A** Cove Raceway Divider Wall (WCM35DW)

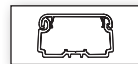

**B** LDPH10 Raceway (LDPH10\*\*)

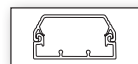

**C** T-45 Raceway Base and Cover (T45B\*\*, T45C\*\*)

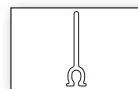

**C** T-45 Raceway Divider Wall (T45DW)

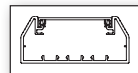

**D** T-70 Raceway Base and Cover (T70B\*\*, T70C\*\*)

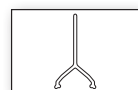

**D** T-70 Raceway Divider Wall (T70DW)

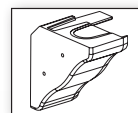

**E** Cove Raceway End Cap (WCM35ECIW)

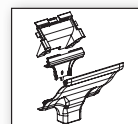

**F** Cove Raceway Low Profile Transition Fitting for LD/LDPH10 Raceway (WCM35TR10IW)

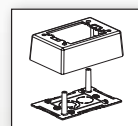

**G** Power Rated Single Gang Two-Piece Box (JBP1\*\*)

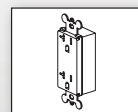

**H** 20 A Rectangular Outlet (ERU20\*\*)

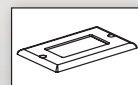

**J** Single Gang Rectangular Electrical/Communication Screw-On Faceplate (CPG\*\*)

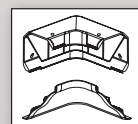

**K** Cove Raceway Inside Corner Fitting (WCM35ICIW)

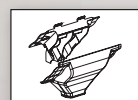

**L** Cove Raceway Transition Fitting for T-45 and LD Series Raceways (WCM35TRIW)

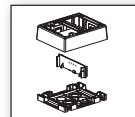

**M** Fast-Snap™ Double Gang Power Rated Surface Mount Outlet Box (JBP2F5\*\*)

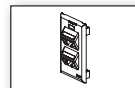

**N** Ultimate ID® Sloped Vertical Snap-On Faceplate (UIT70FV4\*\*)

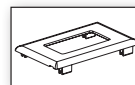

**O** Single Gang Rectangular Electrical/Communication Snap-On Faceplate (T70PG\*\*)

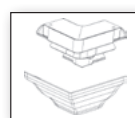

**P** Cove Raceway Outside Corner Fitting (WCM35OCIW)



**Q** Cove Raceway Cover Coupler Fitting (WCM35CCIW)

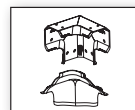

**R** Cove Raceway Tee Fitting (WCM35TIW)

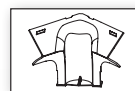

**S** Cove Raceway Tee Fitting Insert (WCM35TI)

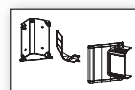

**T** Cove Raceway Low Profile Transition Fitting for T-70 Raceway (WCM35TR70IW)

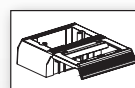

**U** T-70 Workstation Outlet Center™ Offset Box for Snap-On Faceplates (T70WC2\*\*)

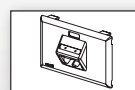

**V** Ultimate ID® Horizontal Snap-On Faceplate (see SA-NCCB51) (UIT70FH2\*\*)



**W** T70 Raceway End Cap Fitting (T70EC\*\*)

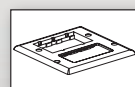

**X** Double Gang Rectangular Electrical and Communication Faceplate (FP2RC\*\*)

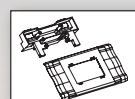

**Y** Cove Raceway Device Box and Faceplate Adapter (WCM35DBFIW)



**Z** Ultimate ID® Horizontal Snap-On Faceplate (UIT70FH4\*\*)

## Office Furniture Raceway

- One-piece, hinged design
- Single channel
- Designed to run on top of office furniture partitions



Note: Office furniture raceway is designed to blend with its environment. Shown in white on office slate furniture for illustration purposes only.

- 1 Choose Raceway Profile
- 2 Choose Fittings
- 3 Choose Accessories





**A** Office Furniture Raceway (OFR20\*\*6)

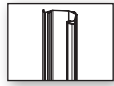
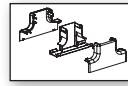

**B** Corner Raceway Base (OFCR70\*\*6)

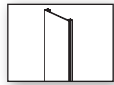
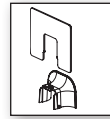

**C** Corner Raceway Cover (OFCRC70\*\*6)

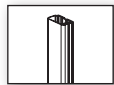
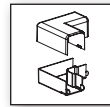

**D** Vertical Raceway (OFVR5\*\*6)

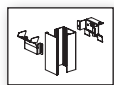
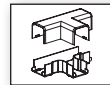

**E** Communication Pole (OFR20CP\*\*8)

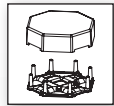
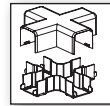

**F** Four Cubicle Drop Fitting (OFR20OFCR70\*\*4)

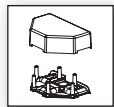
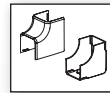

**G** Two Cubicle Drop Fitting (OFR20OFCR70\*\*2)

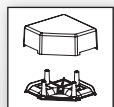
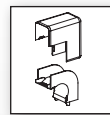

**H** One Cubicle Drop Fitting (OFR20OFCR70\*\*1)

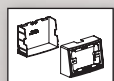
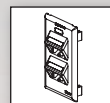
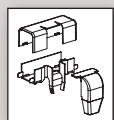
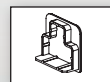

## Additional Pan-Way® Surface Raceway Offerings

### Pan-Way® LDS Surface Raceway System:



- Single channel
- Solid-piece design
- Non-metallic raceway; bendable to route around and over obstructions in low-voltage applications

### Pan-Pole™ Communication Pole

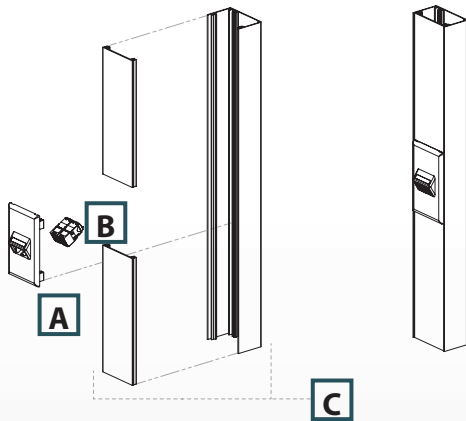

### Pan-Pole™ Power and Communication Poles:

- Available in 11 or 13 foot lengths
- Extension kits can increase height of poles to 16 or 22 feet
- Pan-Pole™ Power Pole: dual-channel aluminum pole with non-metallic cover; pre-terminated with two 20 A factory-installed electrical outlets
- Pan-Pole™ Communication Pole: single-channel aluminum pole with non-metallic cover for routing low-voltage communication cabling only



#### Components Required

A	Single gang vertical sloped communication snap-on faceplate (UIT70FV2**)
B	Mini-Com® Modules
C	Communication pole (PCPA**)



### Surface Raceway Cutting Tool:

- Hand-held tool designed to cut all LD Profile raceway



### Foam Tape:

- Acrylic foam tape has a high-temperature rating and is generally used where exposure to ultraviolet light will occur
- Rubber foam tape is generally used in applications where moderate temperatures are involved



### Pan-Way® Snap-On Faceplates and Surface Mount Outlet Boxes:

- Available for both power and communication applications.
- Fast-Snap boxes and snap-on faceplates assemble without the use of screws.
- Snap-on communication faceplates are available in horizontal or vertical sloped outlet configurations.



## Pan-Way® Surface Raceway Selection Chart/Summary

Product	Description	Application			Internal Area				Page No.
		Data/ Communication Cabling Only	Power Cabling Only	Data and Power Cabling	Small (0 – 2 In. <sup>2</sup> )	Medium (2 – 4 In. <sup>2</sup> )	Large (4 – 7 In. <sup>2</sup> )	X-Large (Over 7 In. <sup>2</sup> )	
T-70	<ul style="list-style-type: none"> <li>Two-piece design</li> <li>Multi-channel (with divider wall)</li> </ul>	X	X	X			X		4, 5
Twin-70	<ul style="list-style-type: none"> <li>Three-piece design</li> <li>Dual channel</li> <li>Further division of channels (with divider wall).</li> </ul>	X	X	X				X	6, 7
TG-70	<ul style="list-style-type: none"> <li>Two-piece design</li> <li>Multi-channel (with divider wall)</li> <li>X-Large internal area</li> </ul>	X	X	X				X	8, 9
T-45	<ul style="list-style-type: none"> <li>Two-piece, hinged design</li> <li>Multi-channel (with divider wall)</li> </ul>	X	X	X		X			10, 11
LD	<ul style="list-style-type: none"> <li>One-piece, hinged design</li> <li>Single channel</li> </ul>	X			X				12,13
LDPH	<ul style="list-style-type: none"> <li>Two-piece, hinged design</li> <li>Single channel</li> <li>Power-rated</li> </ul>	X	X		X				14, 15
LDS	<ul style="list-style-type: none"> <li>One-piece, solid design</li> <li>Single channel</li> </ul>	X	X		X				22
LD2P10	<ul style="list-style-type: none"> <li>One-piece, hinged design</li> <li>Dual channel</li> </ul>	X	X	X	X				16, 17
Cove	<ul style="list-style-type: none"> <li>Two-piece design</li> <li>Multi-channel</li> <li>Designed for corner applications (wall-to-wall; ceiling-to-wall)</li> </ul>	X	X	X			X		18, 19
Office Furniture	<ul style="list-style-type: none"> <li>One-piece, hinged design</li> <li>Single channel</li> <li>Designed to run on top of office furniture partitions</li> </ul>	X				X			20, 21
Pan-Pole™ Power and Communication Poles	<ul style="list-style-type: none"> <li>Provides floor-to-ceiling cable routing</li> </ul>	X	X	X	Internal area is one size only for all Pan-Poles™				22
Surface Raceway Cutting Tool	<ul style="list-style-type: none"> <li>Hand-held tool designed to cut all LD profile raceway</li> </ul>		N/A				N/A		22
Foam Tape	<ul style="list-style-type: none"> <li>Offered in acrylic and rubber</li> </ul>		N/A				N/A		22

## Real-World Solutions

With a proven reputation for excellence and innovation, Panduit and our partners work with you to overcome challenges and implement real-world solutions that create a competitive business advantage. Panduit offers the broadest range of solutions, from data centers and intelligent buildings to manufacturing operations, to help you build a **smarter, unified business foundation**.



### Technology Leadership

Panduit develops innovative physical infrastructure solutions that meet the rapidly changing needs of our clients, from hardware and software to advisory services. This commitment is supported by investment in advanced research, solutions-focused product development, world-class manufacturing, and collaboration with customers at the forefront of technology.



### Partner Ecosystem

Our best-in-class partner ecosystem offers a comprehensive portfolio of services that span the project lifecycle, from planning and design to delivery, deployment, maintenance, and operation. Panduit business partners – distributors, and certified architects, consultants, engineers, designers, system integrators, and contractors – are qualified to help you achieve your objectives and realize predictable and measurable results.



### Strategic Alliances

Panduit cultivates long-term strategic alliances with industry leaders, including Cisco Systems, EMC, IBM, and Rockwell Automation, to develop, optimize, and validate solutions for our customers. This investment in people and resources helps solve our customers' greatest business challenges.



### Global Business Commitment

Panduit is committed to delivering a consistently high level of quality and service the world over. With a presence in more than 100 countries, local Panduit sales representatives and technical specialists offer guidance and support that bring value to your business. Our global supply chain, which includes manufacturing, customer service, logistics, and distribution partners, provides prompt response to your inquiries and streamlines delivery to any worldwide destination.



### Sustainability

With a commitment to environmental sustainability, Panduit develops and implements solutions that protect, replenish, and restore the world in which we live. This commitment is demonstrated by Panduit's LEED Gold certified World Headquarters, leveraging the Unified Physical Infrastructure<sup>SM</sup> approach to enable convergence of critical building systems to drive energy efficiency and ongoing operational improvement.

*Transform Your  
Physical Infrastructure*

*Call or visit us online,  
we can show you how.*

**Panduit Corp.  
World Headquarters  
Tinley Park, IL 60487**

**cs@panduit.com**  
**US and Canada: 800.777.3300**  
**Europe, Middle East, and Africa:**  
**44.20.8601.7200**  
**Latin America: 52.33.3777.6000**  
**Asia Pacific: 65.6305.7575**

**www.panduit.com**

**PANDUIT®**