

THIS COPY IS PROVIDED ON A RESTRICTED BASIS AND IS NOT TO BE USED IN ANY WAY DETRIMENTAL TO THE INTERESTS OF PANDUIT CORP.

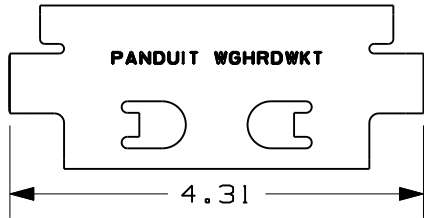

STRAP BRACKET

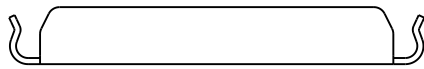
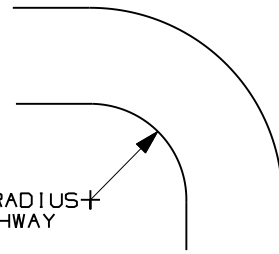
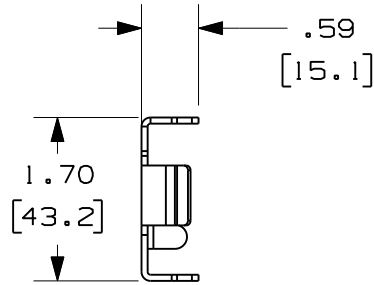

INSIDE RADIUS OF PATHWAY

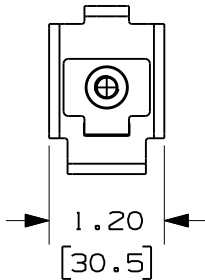
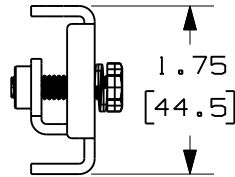
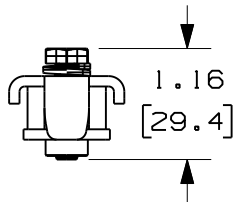

HARDWARE CLIP ASSEMBLY

PANDUIT PART NUMBER	WEIGHT
WGHRDWKT	.29 LBS (133 g)

NOTES

- SEE CURRENT CATALOG FOR PART NUMBER DESIGNATION FOR TYPE AND COLOR.
- WYR-GRID HARDWARE KITS ARE USED WITH WYR-GRID PATHWAYS TO MAKE A SWEEPING RADIUS OF THE SIZE SHOWN IN THE TABLE.
- EACH PACKAGE CONSISTS OF:  
(1) WYR-GRID STRAP BRACKET  
(1) WYR-GRID HARDWARE CLIP ASSEMBLY
- DIMENSIONS IN PARENTHESES ARE METRIC

PATHWAY WIDTH	NUMBER OF WGHRDWKT NEEDED FOR A 90° BEND	INSIDE RADIUS OF PATHWAY CURVATURE
12"	6	15.8"
18"	9	24.4"
24"	12	33.4"
30"	15	41.5"

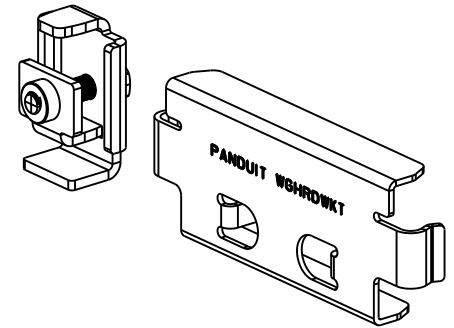

CAD FILENAME/LAYERS 09D017ZD\_DC WGHRDWKT/01A

PANDUIT CORP. TINLEY PARK, ILLINOIS  
WYR-GRID SWEEPING RADIUS  
HARDWARE KIT  
CUSTOMER DRAWING

UNLESS OTHERWISE SPECIFIED,  
DIMENSIONAL TOLERANCES ARE:  
(.X) ± (.XXX) ±  
(.XX) ± .05 (1.3) ANGLES ± 5°

UNLESS OTHERWISE SPECIFIED,  
ALL DIMENSIONS ARE GIVEN  
IN INCHES, THIRD ANGLE PROJECTION.

DRAWN BY  
ERK

MAT'L:  
SEE NOTES  
ABOVE

SCALE  
N/A

R 02-25-11 ERK DWW DRAWING RELEASED

DATE  
02-25-11

DRAWING NO.

DWG

REV DATE BY CHK DESCRIPTION ECN CHK CUST SUP

CHK'D  
DWW

09D017ZD-DC

A  
SIZE