

435NBX-N700
ASCII to PLC Gateway
Product User Guide

Revision: 8.09
Platform: N700

Trademarks

CompactLogix, ControlLogix, & PLC-5 are registered trademarks of Rockwell Automation, Inc. EtherNet/IP is a trademark of the ODVA. MicroLogix, RSLogix 500, and SLC are trademarks of Rockwell Automation, Inc. Microsoft, Windows, and Internet Explorer are registered trademarks of Microsoft Corporation. BACnet® is a registered trademark of American Society of Heating, Refrigerating and Air-Conditioning Engineers (ASHRAE). All other trademarks and registered trademarks are the property of their holders.

Limited Warranty

Real Time Automation, Inc. warrants that this product is free from defects and functions properly.

EXCEPT AS SPECIFICALLY SET FORTH ABOVE, REAL TIME AUTOMATION, INC. DISCLAIMS ALL OTHER WARRANTIES, BOTH EXPRESSED AND IMPLIED, INCLUDING BUT NOT LIMITED TO IMPLIED WARRANTIES OF MERCHANTABILITY OR FITNESS FOR A PARTICULAR APPLICATION. THIS LIMITED WARRANTY GIVES YOU SPECIFIC LEGAL RIGHTS. YOU MAY ALSO HAVE OTHER RIGHTS, WHICH VARY FROM STATE TO STATE.

The examples and diagrams in this manual are included solely for illustrative purposes. Because of the many variables and requirements associated with any particular application, Real Time Automation, Inc. cannot assume responsibility or liability for actual use based on the examples and diagrams. Except as specifically set forth above, Real Time Automation and its distributors and dealers will in no event be liable for any damages whatsoever, either direct or indirect, including but not limited to loss of business profits, income, or use of data. Some states do not allow exclusion or limitation of incidental or consequential damages; therefore, the limitations set forth in this agreement may not apply to you.

No patent liability is assumed by Real Time Automation with respect to use of information, circuits, equipment, or software described in this manual.

Government End-Users

If this software is acquired by or on behalf of a unit or agency of the United States Government, this provision applies: The software (a) was developed at private expense, is existing computer software, and was not developed with government funds; (b) is a trade secret of Real Time Automation, Inc. for all purposes of the Freedom of Information Act; (c) is "restricted computer software" submitted with restricted rights in accordance with subparagraphs (a) through (d) of the Commercial "Computer Software-Restricted Rights" clause at 52.227-19 and its successors; (d) in all respects is proprietary data belonging solely to Real Time Automation, Inc.; (e) is unpublished and all rights are reserved under copyright laws of the United States. For units of the Department of Defense (DoD), this software is licensed only with "Restricted Rights": as that term is defined in the DoD Supplement of the Federal Acquisition Regulation 52.227-7013 (c) (1) (ii), rights in Technical Data and Computer Software and its successors, and: Use, duplication, or disclosures is subject to restrictions as set forth in subdivision (c) (1) (ii) of the Rights in Technical Data and Computer Software clause at 52.227-7013. If this software was acquired under GSA schedule, the U.S. Government has agreed to refrain from changing or removing any insignia or lettering from the Software or documentation that is provided or from producing copies of the manual or media. Real Time Automation, Inc.

© 2021 Real Time Automation, Inc. All rights reserved.

Overview	5
Hardware	6
Powering the Gateway	6
Mounting with a DIN Rail	7
Port Connections.....	8
Accessing the Gateways Configuration Pages	9
Error: Main Page Does Not Launch	10
Committing Changes to the Settings	11
Main Page	12
Device Configuration.....	13
PLC Configuration.....	14
NBX Serial Configuration.....	16
Setting up ASCII to PLC Communication	17
Define PLC Tag / File.....	17
Define ASCII Message Termination.....	18
Message Queue.....	19
Data Conversion.....	19
Setting up PLC to ASCII Communication	20
Define PLC Tag / File.....	20
Add Delimiters to ASCII Message.....	21
Data Conversion.....	21
Diagnostics and Troubleshooting.....	22
PLC Status.....	22
Port & Direction Selection	22
Diagnostics and Troubleshooting – ASCII to PLC	23
Diagnostic Counters	24
Diagnostics and Troubleshooting – PLC to ASCII	25
Diagnostic Counters	26
Diagnostics – Main Page	27
PLC Status.....	27
ASCII Status	27
Device Status.....	28
Save/Load the Configuration	29
Export Configuration.....	29

Import Configuration	29
Utilities	30
Revision Listing.....	30
Diagnostics Logging.....	30
Security Configuration	30
Security - Log In.....	31
Reset Gateway	31
Save and Replace Configuration using SD Card	32
Data Transfer To/From SD Card	32
Using IP Setup with SD Card.....	32
Appendix A: Error Definitions	33
Appendix B: I/O Messaging - Configuration (Rev 7.03 or Later).....	37
Input / Output Assembly Byte Breakdown	37
Input / Output Assembly Handshaking Breakdown.....	38
ASCII to PLC	38
PLC to ASCII	38
Input / Output Assembly Diagnostics Breakdown	38
Appendix C: Create User Defined Tag in RSLogix 5000.....	39
Appendix D: How to Access Program Scope Tags in RSLogix 5000.....	40
Appendix E: Importing UDT_435NBX_Diagnostics.L5X	41

Overview

The 435NBX gateway seamlessly connects up to 2 ASCII devices to a ControlLogix, CompactLogix, FlexLogix, MicroLogix, PLC5E, SLC, or other legacy PLC featuring a NetENI module.



Tools and documents available online: <http://www.rtautomation.com/product/435-nbx-support/>

If at any time you need further assistance do not hesitate to call Real Time Automation support.

Support Hours are Monday-Friday 8am-5pm CST

Toll free: 800-249-1612

Email: support@rtautomation.com

Hardware

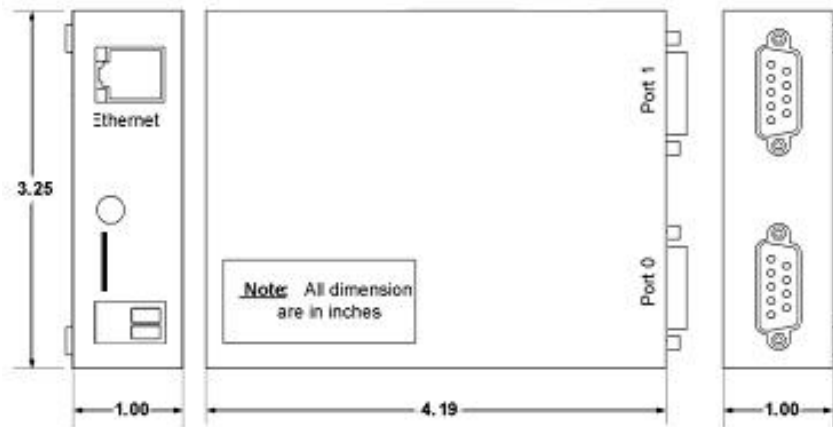

Din Rail



Panel Mount



Powering the Gateway

- The gateway requires a 8-24 VDC power source
Red = (+) Black = (-).
 - The unit draws 100mA @ 12VDC
 - The unit draws 50mA @24VDC



Mounting with a DIN Rail

Installing

Follow these steps to install your unit.

- 1) Mount your DIN Rail.
- 2) Hook the bottom mounting flange under the DIN Rail.
- 3) While pressing the 435NBX against the rail, press up to engage the spring loaded lower clip and rotate the unit parallel to the DIN Rail.
- 4) Release upward pressure.

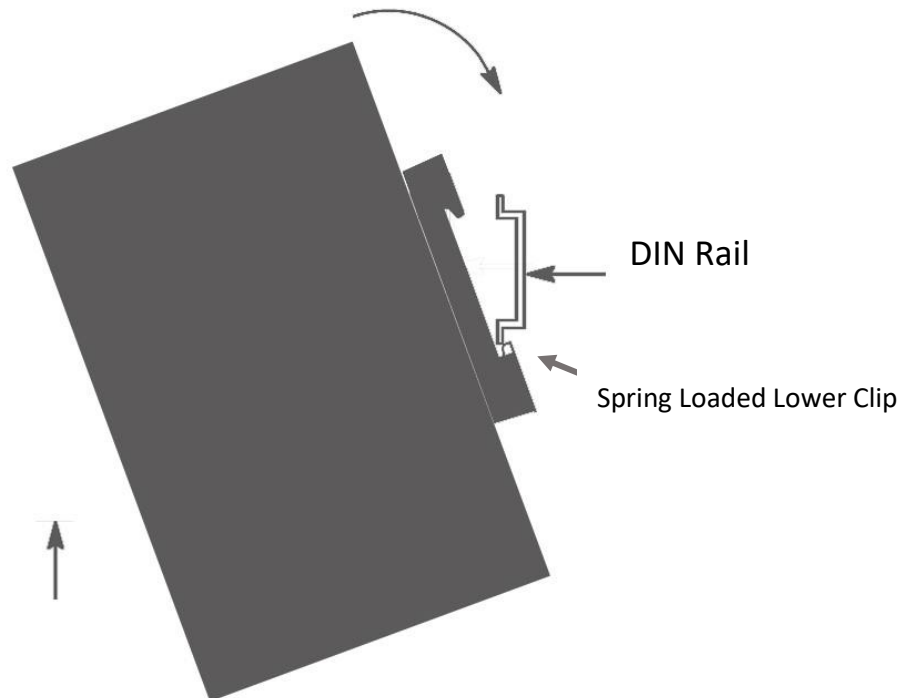

Removing

Follow these steps to remove your unit.

- 1) Press up on the unit to engage the spring loaded lower clip.
- 2) Swing top of the unit away from the DIN rail

Port Connections

The factory default port settings for Port 0 and Port 1 are RS-232. If the default port settings are not compatible with your ASCII device, Port 0 can be configured for RS-232, RS-485, or RS-422. Port 1 can only be configured for RS-232.

Jumper Configuration

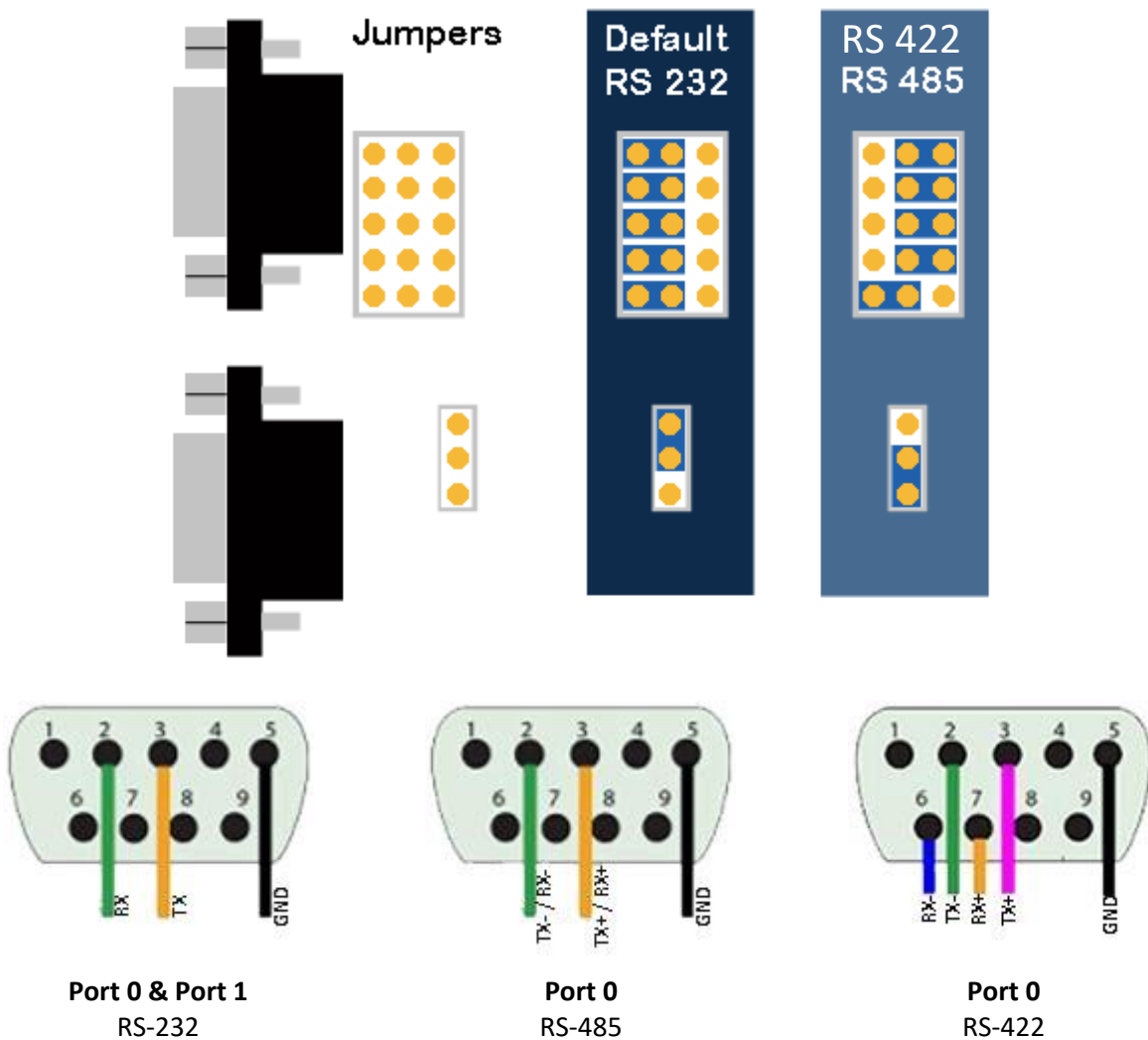

The default jumper configurations are setup for the following serial modes:

- Port 0 – RS-232
- Port 1 – RS-232

Accessing the Gateways Configuration Pages

Access the browser-based configuration of the 435NBX. By default, DHCP is enabled. If the 435NBX fails to obtain an IP address over DHCP it will Auto IP with 169.254.X.Y.

- Connect an 8-24 VDC power source to the gateway, Red Wire = (+) Black Wire = (-).
- Using the supplied crossover cable, connect the gateway to the PC.
- Insert the provided CD-ROM into a computer also on the network. (Refer to the Accessing_Browser_Configuration doc on the cd to setup DHCP on your PC).

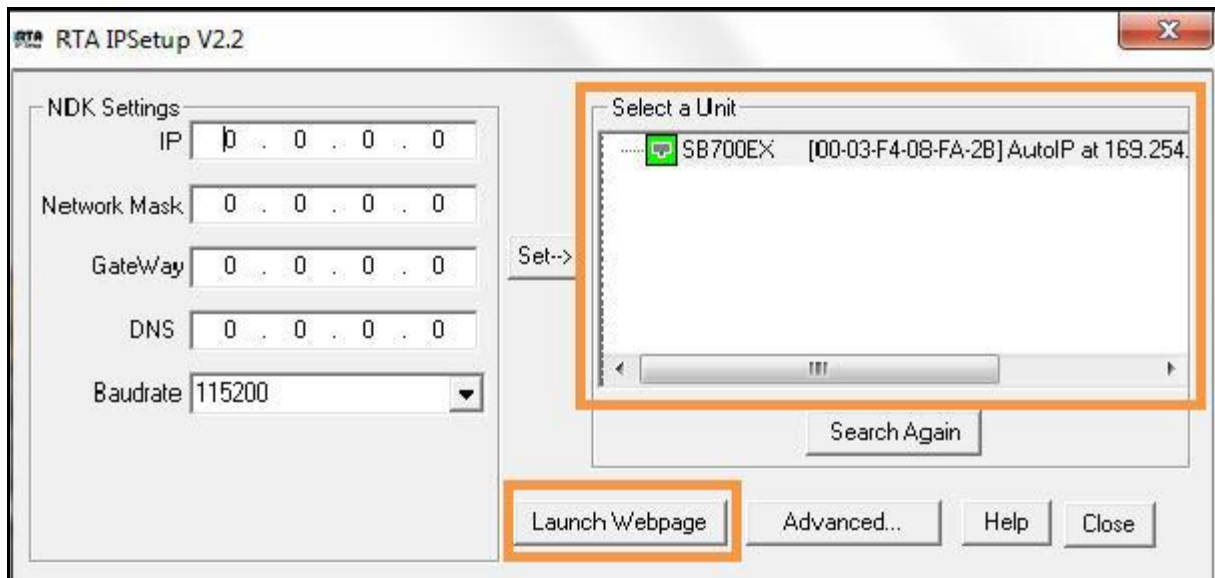

- Run the IPSetup.exe program from the CD-ROM.
- Find unit under “Select a Unit”.
 - To change the IP address to match that of your PC if DHCP has failed, enter the desired static IP settings on the left hand side and click Set.
 - You will know DHCP has failed if the gateway’s IP address is AutoIP at 169.254.X.Y.
 - If successful it will say DHCP’d at ex: 192.168.0.100 or however your DCHP Client is set up.
- Click **Launch Webpage**. The Main Page should appear.

Default setting is set to DHCP. If DHCP fails, default IP address is 169.254.x.y

Error: Main Page Does Not Launch

If the Main Page does not launch, please verify the following:

1. Check that the PC is set for a valid IP address
 - a. Open a MS-DOS Command Prompt
 - b. Type "ipconfig" and press enter
 - c. Note the PC's IP address, Subnet, and Default Gateway
2. The gateway must be on the same Network/Subnet as the PC whether its setup for DHCP/Static.

Once you have both devices on the same network, you should be able to ping the gateway using a MS-DOS Command Prompt.

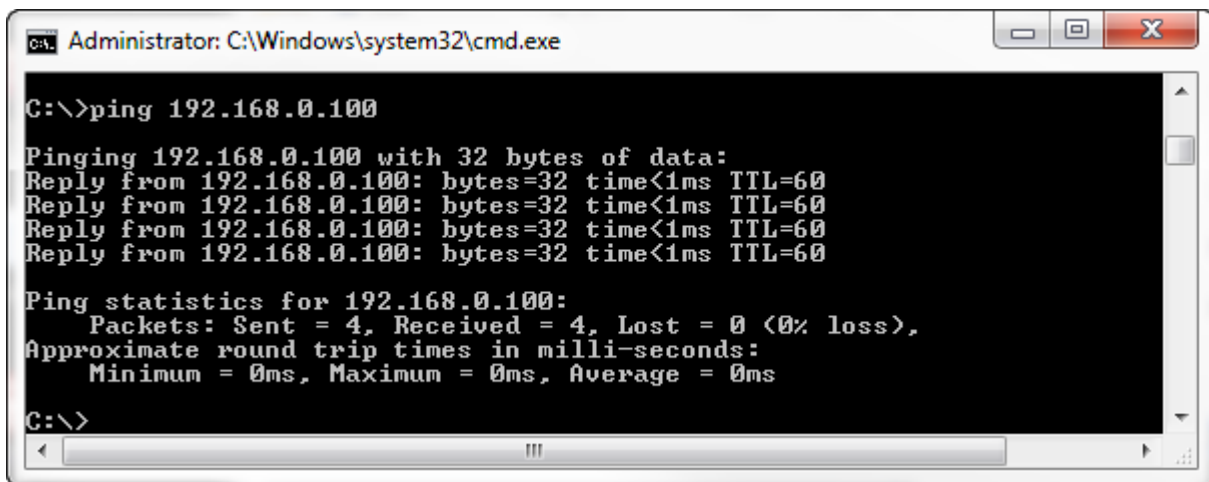

```
Administrator: C:\Windows\system32\cmd.exe
C:\>ping 192.168.0.100

Pinging 192.168.0.100 with 32 bytes of data:
Reply from 192.168.0.100: bytes=32 time<1ms TTL=60
Reply from 192.168.0.100: bytes=32 time<1ms TTL=60
Reply from 192.168.0.100: bytes=32 time<1ms TTL=60
Reply from 192.168.0.100: bytes=32 time<1ms TTL=60

Ping statistics for 192.168.0.100:
    Packets: Sent = 4, Received = 4, Lost = 0 (0% loss),
    Approximate round trip times in milli-seconds:
        Minimum = 0ms, Maximum = 0ms, Average = 0ms

C:\>
```

The Screenshot above shows a gateway that is currently set to a static IP address of 192.168.0.100.

If you are able to successfully ping your gateway, open a browser and try to view the main page of the gateway by entering the IP address of the gateway as the URL.



Committing Changes to the Settings

- Any changes made to the IP address or DHCP settings will take effect immediately.
- All other changes made to the settings of the gateway will not take effect until the gateway is restarted. Changes will not be stored if the gateway's power is removed prior to a reboot.
- The gateway detects changes and will prompt you with a red notice box to restart the gateway after change.

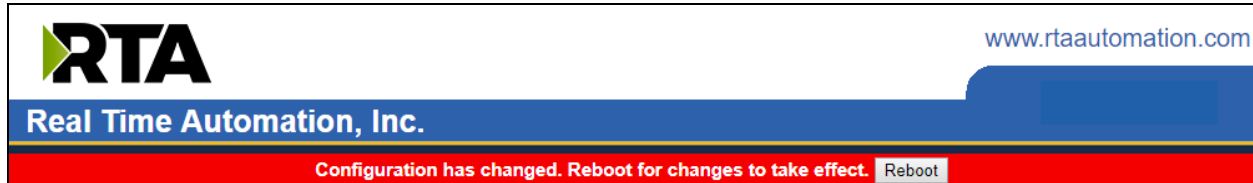

- **NOTE:** The gateway does not need to be restarted after every change. Multiple changes can be made before a restart, but they will not be committed until the gateway is restarted.
- When all desired changes have been made, press the **Reboot** button.
- The webpage will redirect to our rebooting page shown below:

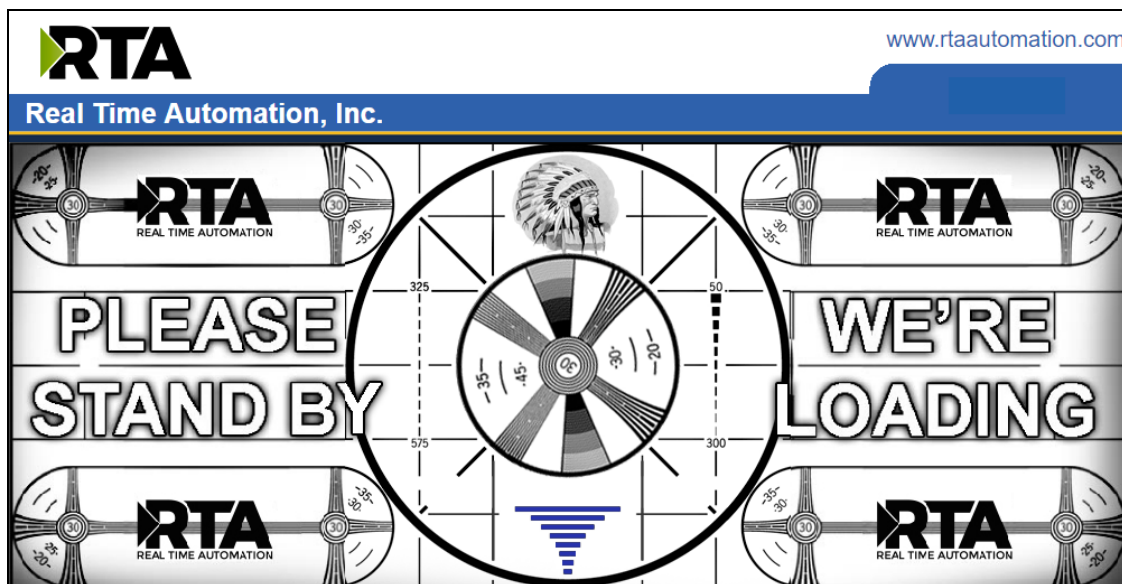

- The reboot can take up to 20 seconds. You will know the save was successful if the red box is no longer present.
 - If the IP address has not been modified, the gateway will automatically redirect to the main page.
 - If the IP address was modified, a message will appear at the top of the page to instruct the user to manually open a new webpage at that new IP.

FUN FACT:

The load screen pays homage to the RCA Television test pattern used from 1939-1970. The Native American head was used to check brightness and contrast, the corner circles check beam focus on the edges of the screen, the bars for low frequency response and the large circle to test height.

Main Page

The main page is where important information about your gateway and its connections are displayed.

Navigation (green box below):

You can easily navigate between pages (Main, Configuration, Diagnostics, and Other pages) using the buttons on the left hand side.

Device Status (orange box below):

This quickly shows the high-level status of any ASCII Ports that are enabled in the serial configuration. The values on this page mimic the same values that are displayed on the Diagnostics Page.



Main Page

Device Configuration:

Device Description: Location / Application
 IP Settings: Obtain an IP Address Automatically
 IP Address: 192.168.47.56
 Subnet: 255.255.255.0
 Default Gateway: 192.168.47.1

Ethernet Link: 100 Mbps, Half Duplex
 MAC Address: 00:03:F4:08:2B:BE
 Build Date: Feb 4 2016

PLC Status: No PLC Configured Connection Attempts: 0

ASCII Status: No Messages RX or TX

Device Status:

	ASCII to PLC Status	PLC to ASCII Status
0:	Tag/File Not Yet Defined	Tag/File Not Yet Defined
1:	Tag/File Not Yet Defined	Tag/File Not Yet Defined

Device Configuration

- 1) From the main page, click the **Edit** button which is located next to *Device Configuration*.

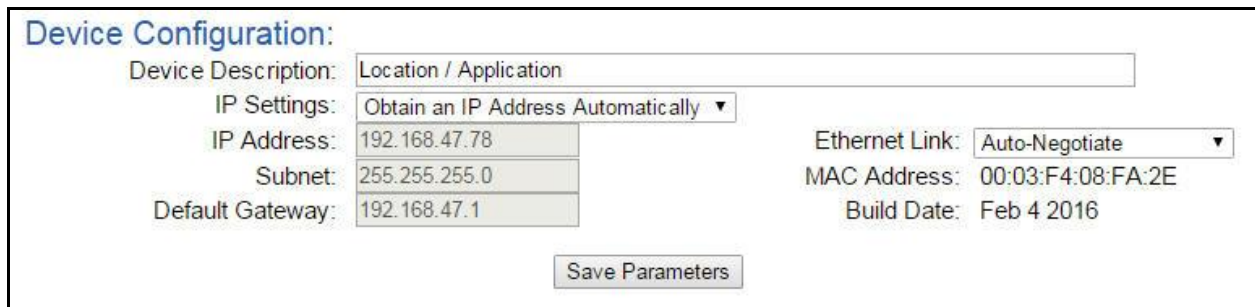

- 2) This allows you to edit the Device Description, IP Settings, IP Address, Subnet, Default Gateway and Ethernet Link settings.

A screenshot of a web form titled "Device Configuration:". The form contains several fields: "Device Description:" with a text input field containing "Location / Application"; "IP Settings:" with a dropdown menu showing "Obtain an IP Address Automatically"; "IP Address:" with a text input field containing "192.168.47.78"; "Subnet:" with a text input field containing "255.255.255.0"; "Default Gateway:" with a text input field containing "192.168.47.1"; "Ethernet Link:" with a dropdown menu showing "Auto-Negotiate"; "MAC Address:" with a text input field containing "00:03:F4:08:FA:2E"; and "Build Date:" with a text input field containing "Feb 4 2016". At the bottom center of the form is a button labeled "Save Parameters".

- 3) To save all values, click the **Save Parameters** button.

NOTE: Once Save Parameters is pressed, new IP Settings take effect immediately.

PLC Configuration

- 1) Click the **PLC Configuration** button under the *CONFIGURATION* section.

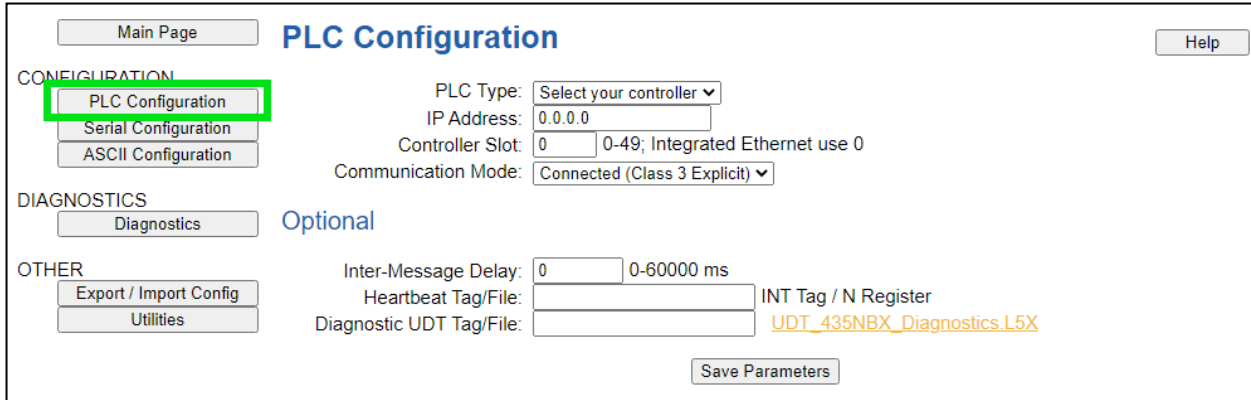

The screenshot shows the 'PLC Configuration' web page. On the left, there is a navigation menu with sections: CONFIGURATION (containing 'PLC Configuration', 'Serial Configuration', and 'ASCII Configuration'), DIAGNOSTICS (containing 'Diagnostics'), and OTHER (containing 'Export / Import Config' and 'Utilities'). The 'PLC Configuration' button is highlighted with a green box. The main content area is titled 'PLC Configuration' and includes a 'Help' button in the top right. The configuration fields are:

- PLC Type: Select your controller (dropdown menu)
- IP Address: 0.0.0.0 (text input)
- Controller Slot: 0 (text input) with a note '0-49; Integrated Ethernet use 0'
- Communication Mode: Connected (Class 3 Explicit) (dropdown menu)
- Inter-Message Delay: 0 (text input) with a range '0-60000 ms'
- Heartbeat Tag/File: (text input) with a label 'INT Tag / N Register'
- Diagnostic UDT Tag/File: (text input) with a link 'UDT_435NBX_Diagnostics.L5X'

 A 'Save Parameters' button is located at the bottom center of the configuration area.

- 2) PLC Type: Select which PLC you are using.
 - a. If using a Logix PLC, all processors are compatible.
 - b. If using a PLC5E, then it must be: Series C, Revision N.1 or later; Series D, Revision E.1 or later; or Series E, Revision D.1 or later.
 - c. If using a SLC5/05, then it must be: Series A, Version OS501; or FRN5 Series B and Series C or later.
 - d. If using a NetENI module, select based on the processor it is connected to.
 - e. If connecting to an I/O Scanner, please see User Guide, [Appendix B](#) for more details.
- 3) IP Address: Enter the IP address of the PLC.
 - a. If using I/O Scanner, this is the IP Address of the PLC.
 - i. If the IP address is 0.0.0.0, the gateway will accept messages from any device.
- 4) Controller Slot: Enter the slot that the Controller is located in.
 - a. If you are using an Integrated Ethernet Card, enter slot 0.
 - b. For Logix processors, this is **NOT** the slot of the Ethernet Adapter.
- 5) Communication Mode: **Connected (Class 3 Explicit)** messaging relies on reserved resources to transfer data to/from the PLC. **Connected (Class 3 Explicit)** messaging is recommended if you are reading and writing and always want to keep that connection open to the PLC.

Unconnected (UCMM) messaging relies on shared resources to transfer data to the PLC. This could result in message timeouts if there are a lot of devices fighting for these shared buffers. If you don't want the RTA gateway to constantly keep the connection open to the PLC but only maintain a connection when there is data needed to be transferred, then Unconnected (UCMM) will work best if you are only writing to the PLC.

- 6) Inter-Message Delay: The Inter-Message Delay is a forced delay for each request the gateway sends to the PLC.
 - a. This setting will affect the speed at which a message is delivered and the amount of traffic the gateway adds to the network.
 - b. If set to 0, the gateway will communicate as fast as possible to the PLC and generate the most traffic.
 - c. In applications with a heavy network, it is recommended that you increase this delay to limit network traffic.

- 7) Heartbeat Tag/File: This Tag or File will act as an incremental counter for messages passed through the gateway.
 - a. For RSLogix5000 Family: This should be an INT Data Type Tag.
 - b. For RSLogix500 Family: This should be an N Register.
 - c. This can be used to monitor if the gateway has stopped communicating with the PLC.
Note: If using the Diagnostic UDT, you can use the tag name of your UDT with a .Heartbeat after it. Example: If UDT Tag = RTA435UDT then your Heartbeat tag would be RTAUDT.Heartbeat.

- 8) Diagnostic UDT Tag/File: Enter a Tag/File that is defined in the PLC.
If using RSLogix 5000, this Tag must use the UDT link provided (right click as save as).
If using RSLogix 500, create a N file with 6 elements.
 - a. **Heartbeat:** free running counter to let the PLC know that the 435 / 490 is active.
 - b. **Bit_Map_Status:** bit map of the ASCII devices communicating.
 - i. Value 1 = Port 0 is TX/RX data
 - ii. Value 2 = Port 1 is TX/RX data
 - iii. Value 3 = Both ports are TX/RX data.
 - c. **ASCII_Event_Delimiter:** number of messages called complete due to delimiters (combined for both ports).
 - d. **ASCII_Event_Length:** number of messages called complete due to max number of characters received (combined for both ports).
 - e. **ASCII_Event_Timeout:** number of messages called complete due to the timer being reached (combined for both ports).
 - f. **ASCII_Event_Discard:** number of messages called complete, but the RTA unit had to discard them due to the queue being full (combined for both ports).

For step-by-step instruction on how to set up the UDT, please see [Appendix E](#).

NBX Serial Configuration

- 1) From any page, click the **Serial Configuration** button under the *CONFIGURATION* section.

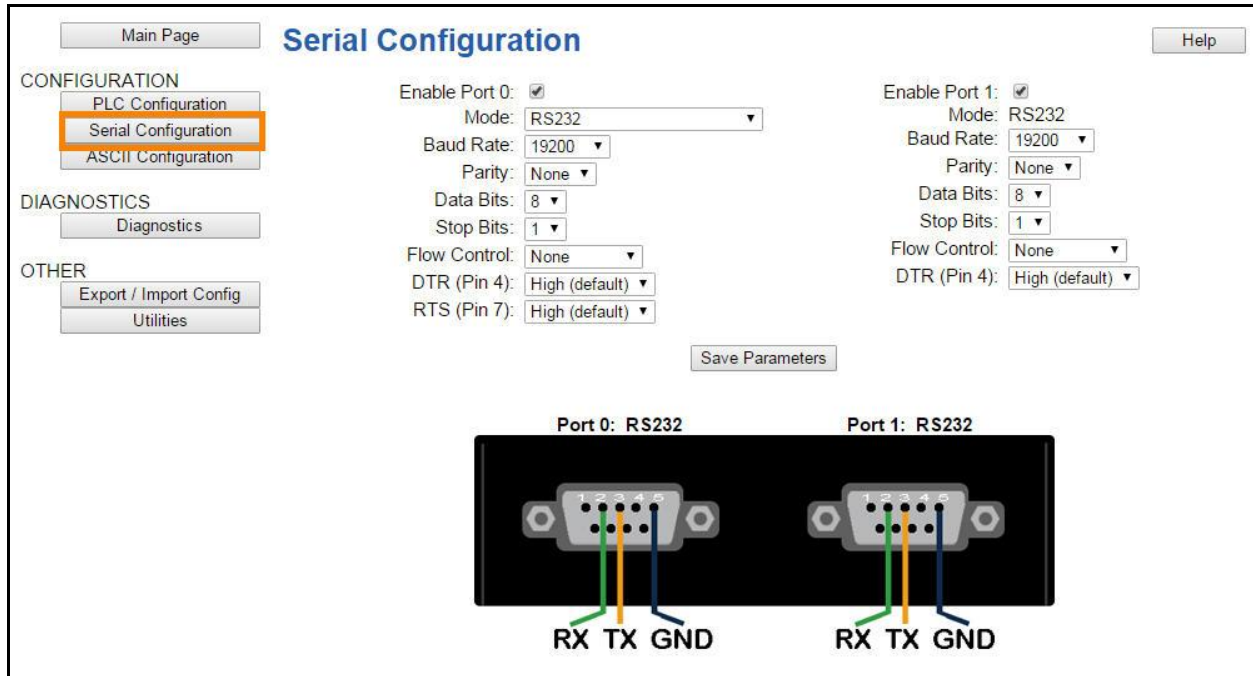

The screenshot displays the 'Serial Configuration' web page. On the left, a navigation menu includes 'Main Page', 'CONFIGURATION' (with sub-items 'PLC Configuration', 'Serial Configuration', and 'ASCII Configuration'), 'DIAGNOSTICS' (with 'Diagnostics'), and 'OTHER' (with 'Export / Import Config' and 'Utilities'). The 'Serial Configuration' page is active, showing settings for two ports. Both 'Enable Port 0' and 'Enable Port 1' are checked. Both ports are set to 'RS232' mode, '19200' Baud Rate, 'None' Parity, '8' Data Bits, and '1' Stop Bits. 'Flow Control' is set to 'None' for both. 'DTR (Pin 4)' and 'RTS (Pin 7)' are both set to 'High (default)'. A 'Save Parameters' button is centered below the settings. At the bottom, two RS232 port diagrams are shown, labeled 'Port 0: RS232' and 'Port 1: RS232'. Each diagram has three colored lines: green for RX, orange for TX, and blue for GND.

- 2) By default, both ports are enabled. If you would like to disable communication on a port, uncheck the checkbox.
- 3) All serial settings must match the serial device being connected. If any of these fields are incorrect, proper communication will not be possible.

See the [Port Connections](#) section for more information on Mode and hardware configuration.

Setting up ASCII to PLC Communication

Click the **ASCII Configuration** button under the *CONFIGURATION* section.

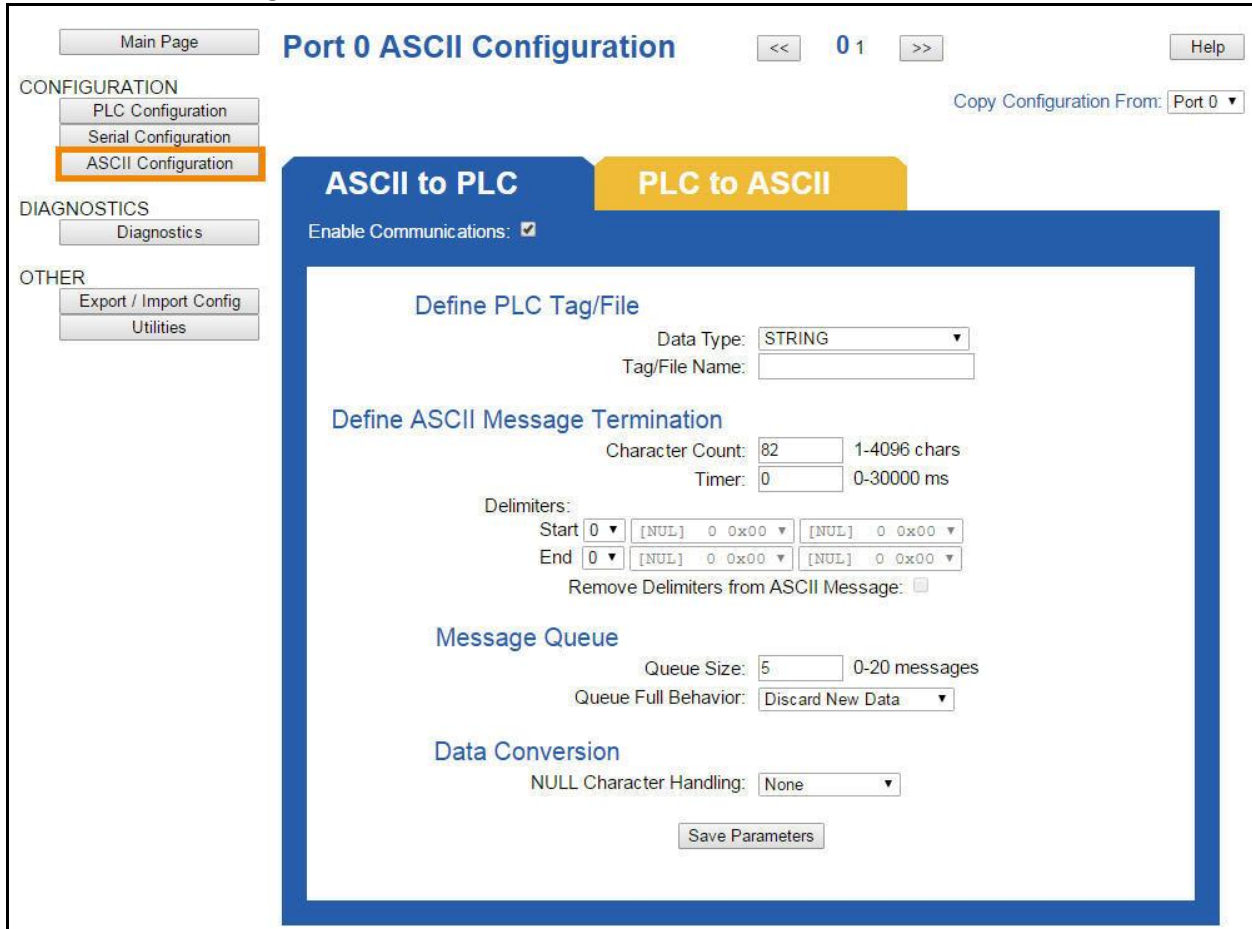

Define PLC Tag / File

- 1) Data Type: Select the Data Type for the Tag / File Name that you defined in the PLC.
 - a. If PLC Type configured is I/O Scanner, then this field is not used.
- 2) Enter the Tag / File name you want the gateway to move the ASCII message to.
 - a. The Tag / File must be defined in the PLC and must match exactly.
 - b. Most of the time, the Tag Name is defined within the Controller Scope of the PLC for Read/Write Access.
 - i. See [Appendix D](#) for instructions on how to configure your gateway for a Program Scope Tag.
 - c. If PLC Type configured is I/O Scanner, then this field is not used.

Define ASCII Message Termination

- 1) To define an ASCII message, you must select one or more of the following end cases: Character Count, Timer, or Delimiters.
 - a. **Character Count:** Enter the max number of characters that the device could output.

Example: If your device sends a four digit temperature, set the length to 4.

 - i. If using an INT Data Type, this is also the dimension size/2 + 1 of the Tag / File.
 - ii. If using a SINT Data Type, this is also the dimension size + 2 of the Tag / File.
 - iii. For Controllers using RSLogix 5000, the range for each data type is:
 - ◆ STRING/INT/SINT: 1-4096 characters
 - ◆ STRING– If using more than 82 characters, a User Defined Data Type must be created within the PLC and used. Refer to [Appendix C](#) for instructions.
 - ◆ For Controllers using RSLogix 500, the range for each data type is:
 - ◆ STRING: 1-82 characters
 - ◆ INT: 1-200 characters
 - ◆ SINT: Not Used
 - b. **Timer:** Use this option if your device sends data of varying lengths and does not have end delimiters. This is the amount of time we will wait after the last character of a message before considering the message complete.
 - c. **Delimiters**
 - i. **Start:** Select how many Start Delimiters to look for in the ASCII message. Use this feature if the ASCII message has common starting delimiter(s), (characters at the beginning of every message).
 - ◆ The value of this first dropdown will either gray out or allow a delimiter to be selected from the next dropdown.
 - ii. **End:** Select how many End Delimiters to look for in the ASCII message. Use this feature if the ASCII message has common end delimiter(s). <CR><LF> is a common example.
 - ◆ The value of this first dropdown will either gray out or allow a delimiter to be selected from the next dropdown.
 - iii. **Remove Delimiters:** If using any Start or End Delimiters and you do not want them to be sent to the PLC, then enable this checkbox.

Message Queue

- 1) Queue Size: Enter the number of complete messages you want the gateway to hold before discarding.
- 2) Queue Full Behavior: If the queue is full, the gateway will discard messages one of the following ways:
 - a. Discard New Data: Gateway will discard any new messages.
 - b. Overwrite Oldest Data: Gateway will overwrite oldest message with new data.

Data Conversion

- 1) NULL Character Handling: Select how the gateway will handle the NULL Character.
 - a. None (Default): Does no additional conversion to the data before sending it to the PLC.
 - b. Remove NULL: Removes all NULL characters from the ASCII Message before sending it to the PLC.

Ex: ASCII device is sending data "\$00This \$00is \$00a \$Test\$00\$00", The RTA will remove the NULLS (\$00) and only send "This is a Test" to the PLC.

Setting up PLC to ASCII Communication

Click the **ASCII Configuration** button under the *CONFIGURATION* section.

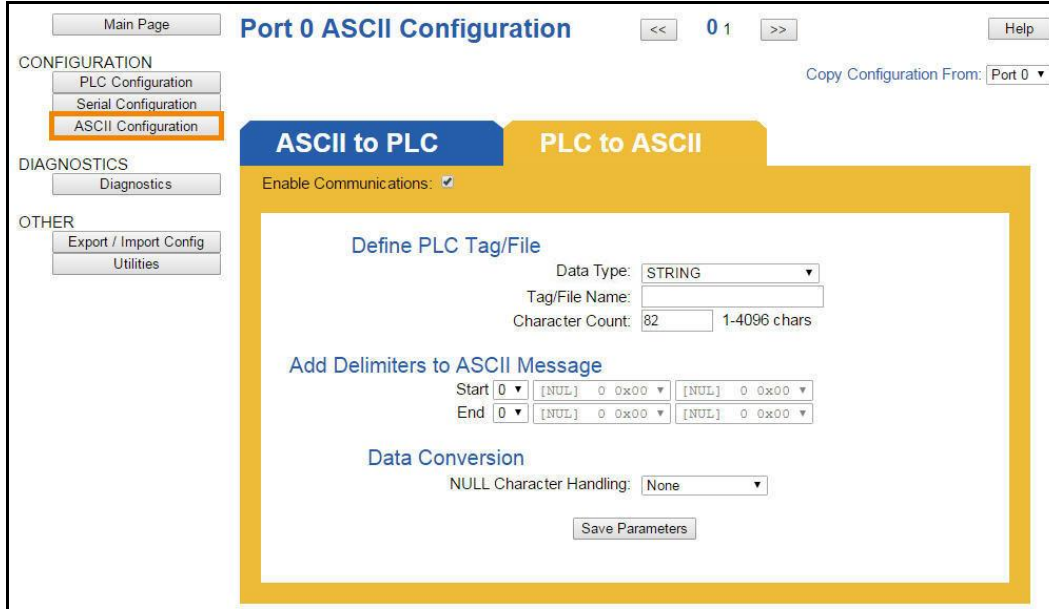

Define PLC Tag / File

- 1) Data Type: Select the Data Type for the Tag / File Name that you defined in the PLC.
 - a. If PLC Type configured is I/O Scanner, then this field is not used.
- 2) Enter the Tag / File name that you want the gateway to monitor for messages.
 - a. The Tag / File must be defined in the PLC and must match exactly.
 - b. Most of the time, the Tag Name is defined within the Controller Scope of the PLC for Read/Write Access.
 - i. See [Appendix D](#) for instructions on how to configure your gateway for a Program Scope Tag.
 - c. If PLC Type configured is I/O Scanner, then this field is not used.
- 3) Character Count: Enter the maximum number of characters that the gateway can send to the ASCII device.
 - a. If using an INT Data Type, this is also the dimension size/2 + 1 of the Tag / File.
 - b. If using a SINT Data Type, this is also the dimension size + 2 of the Tag / File.
 - c. For Controllers using RSLogix5000, the range for each data type is:
 - i. STRING/INT/SINT: 1-4096 characters.
 - ii. STRING– If using more than 82 characters, a User Defined Data Type must be created within the PLC and used. Refer to [Appendix C](#) for instructions.
 - d. For Controllers using RSLogix500, the range for each data type is:
 - i. STRING: 1-82 characters
 - ii. INT: 1-200 characters
 - iii. SINT: Not Used

Add Delimiters to ASCII Message

- 1) Delimiters: Configure the characters to add to the message.
 - a. Start: Use this feature to add a common starting delimiter(s) to messages being sent to the ASCII device.
 - i. The value of this first dropdown will either gray out or allow a delimiter to be selected from the next dropdown.
 - ii. Use this feature only if your ASCII device requires such delimiters.
 - iii. All ASCII messages will receive the starting delimiters selected.
 - b. End: Use this feature to add a common end delimiter(s) to messages being sent to the ASCII device.
 - i. The value of this first dropdown will either gray out or allow a delimiter to be selected from the next dropdown.
 - ii. Use this feature only if your ASCII device requires such delimiters.
 - iii. All ASCII messages will receive the end delimiters selected.

Data Conversion

- 1) Data Conversion:
 - a. None (Default): Does no additional conversion on the data before sending it from the gateway to the ASCII device.
 - b. Prepend NULL: Adds a NULL character to the beginning of each message that is to be sent from the gateway to the ASCII device.

EX: Data sent from the PLC "This is a Test", the ASCII device will receive the data as: shown in
HEX: 00 74 00 68 00 69 00 73 00 20 00 69 00 73 00 20 00 61 00 20 00 74 00 65 00 73 00 74

- c. Postpend NULL: Adds a NULL character to the end of each message that is to be sent from the gateway to the ASCII device.

EX: Data sent from the PLC "This is a Test", the ASCII device will receive the data as: shown in
HEX: 74 00 68 00 69 00 73 00 20 00 69 00 73 00 20 00 61 00 20 00 74 00 65 00 73 00 74 00

Diagnostics and Troubleshooting

From any page, click the **Diagnostics** button under the *DIAGNOSTICS* section.

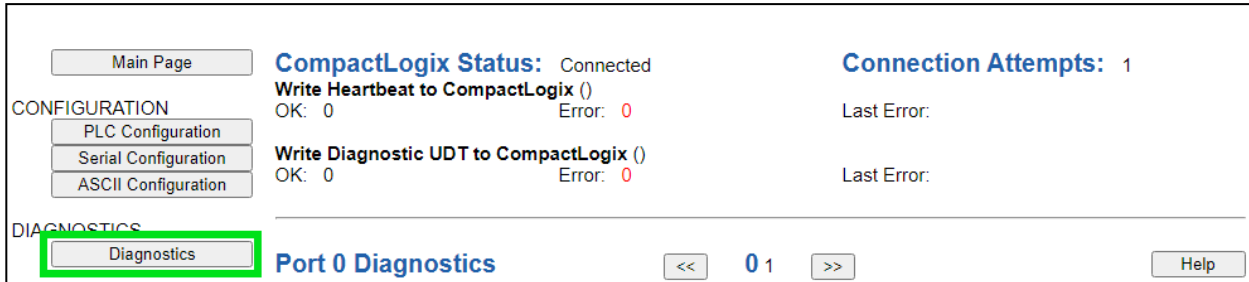

The screenshot shows the RTA web interface. On the left, there are navigation buttons: 'Main Page', 'CONFIGURATION' (with sub-buttons for 'PLC Configuration', 'Serial Configuration', and 'ASCII Configuration'), and 'DIAGNOSTICS' (with a 'Diagnostics' button highlighted in green). The main content area shows 'CompactLogix Status: Connected' and 'Connection Attempts: 1'. Below this, there are two sections for writing heartbeats to the PLC: 'Write Heartbeat to CompactLogix ()' and 'Write Diagnostic UDT to CompactLogix ()'. Each section shows 'OK: 0' and 'Error: 0', with a 'Last Error:' field. At the bottom, there is a 'Port 0 Diagnostics' section with navigation buttons '<<', '0 1', and '>>', and a 'Help' button.

PLC Status

PLC Status: Shows the same information that is on the main page diagnostics. See the [Diagnostics-Main Page](#) section for further explanations.

Connection Attempts: This value increments every time the 435NBX loses connection to the PLC and attempts to reconnect.

Write Heartbeat to PLC:

OK: Number of successful write messages to heartbeat Tag/File Name.

Error: Number of failed write messages to heartbeat Tag/File Name.

Last Error: Specific error information pertaining to the last failed heartbeat message to the PLC.

Port & Direction Selection

Port Selection: Use the << and >> buttons to navigate to the desired port diagnostics.

Direction Selection: Use the **ASCII to PLC** / **PLC to ASCII** tabs to select the direction you want to view.

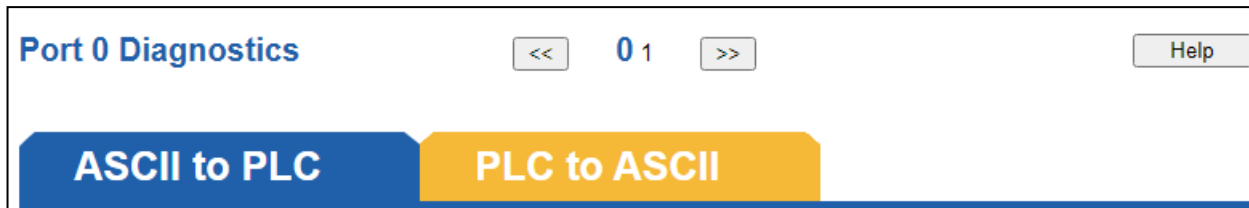

The screenshot shows the 'Port 0 Diagnostics' section. It features navigation buttons '<<', '0 1', and '>>', and a 'Help' button. Below these are two tabs for direction selection: 'ASCII to PLC' (blue tab) and 'PLC to ASCII' (yellow tab).

Diagnostics and Troubleshooting – ASCII to PLC

This page will automatically refresh to show the latest data.

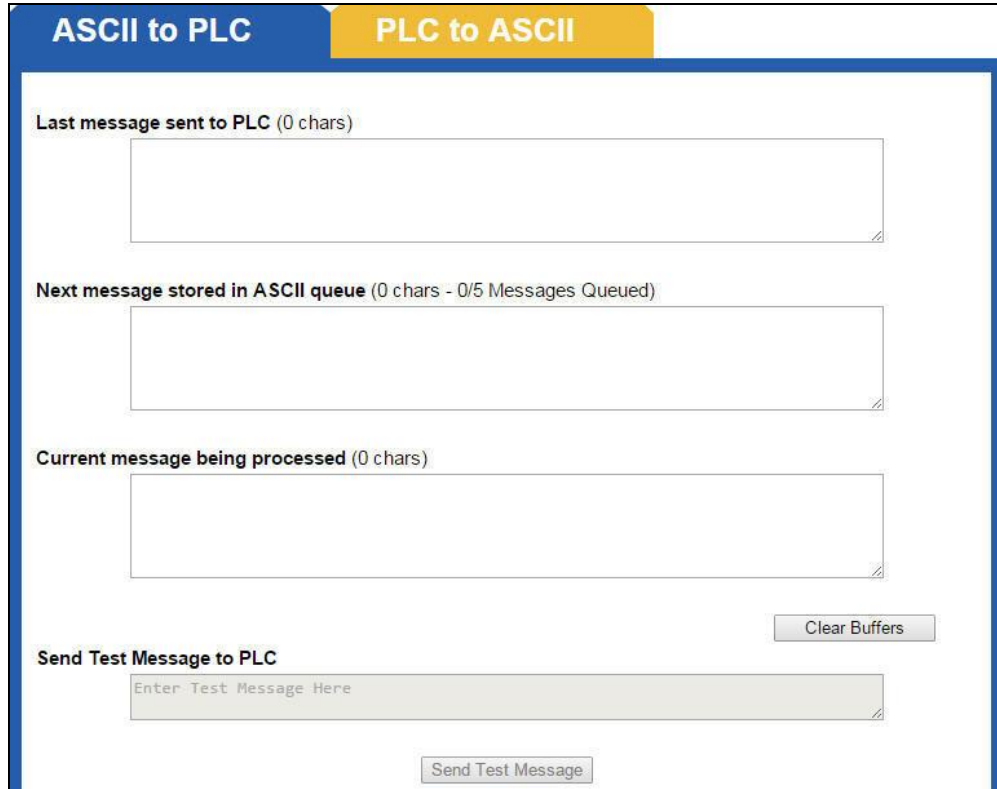

Last message sent to PLC (chars):

This buffer shows the last message that was successfully sent to the PLC.

Next message stored in ASCII queue (chars – messages queued):

This buffer shows the next ASCII message waiting to be sent. This ASCII message will only be sent to the PLC if the Length field within the Tag/File is set to zero, indicating the last message has been processed.

- When using String Data Type, the .LEN needs to be set to 0.
- When using INT Data Type, the 1st array index [0] needs to be set to 0.
- When using SINT Data Type, the 1st and 2nd array index [0] & [1] needs to be set to 0.

Current message being processed (chars):

This buffer shows the real time data that the ASCII device is sending out to the 435NBX gateway. All data in this buffer is pending due to one of the three end cases not being met. Those end cases are Character Count, Timer, and Delimiters.

Send Test Message to PLC:

Use this field to send a test message to the PLC.

- PLC and Port must be configured to use this feature.
- This message will not work if buffer is already full. Message will be discarded.

Diagnostic Counters

Diagnostic Counters

ASCII Event
 Delimiter: 0 Length: 0 Timeout: 0 Discards: 0

Read Handshake Message from PLC
 OK: 0 Error: 0 Last Error:

Write ASCII Message to PLC
 OK: 0 Error: 0 Last Error:

ASCII Event:

Delimiter: Increments if a successful ASCII message was received with delimiters being read.

Length: Increments if a successful ASCII message was received containing the max character count.

Timeout: Increments if a successful ASCII message was received with the timer value being reached.

Discards: Increments if a message was thrown away due to the ASCII queue buffer being full.

Read Handshake Message from PLC:

OK: Increments when the length field is non-zero in the PLC.

Error: Increments when there is an error with the Tag/File in the PLC.

Last Error: This will report the most recent error.

Note: Errors that show up here are reported from either the 435NBX or the PLC. For detailed errors and explanations, please see [Appendix A](#).

Write ASCII Message to PLC:

OK: Increments with every successful message sent from ASCII to the PLC.

Error: Increments when there is an error writing the Tag / File.

Last Error: This will report the most recent error found.

Note: Errors that show up here are reported from either the 435NBX or the PLC. For detailed errors and explanations, please see [Appendix A](#).

Diagnostics and Troubleshooting – PLC to ASCII

This page will automatically refresh to show the latest data.

ASCII to PLC
PLC to ASCII

Last message sent to ASCII (0 chars)

Send Test Message to ASCII

Enter Test Message Here

Diagnostic Counters

Read ASCII Message from ControlLogix

OK: 0	Error: 0	Last Error:
-------	----------	-------------

Write Handshake Message to ControlLogix

OK: 0	Error: 0	Last Error:
-------	----------	-------------

Last message sent to ASCII (chars):

This buffer shows the last message that was sent to the ASCII device. Data portion should be filled in first and then the Length field. When the Length is non-zero, the gateway will process it and then set to 0, indicating another message can be sent.

- When using String Data Type, length is set using the .LEN field.
- When using INT Data Type, the length is the 1st array index [0].
- When using SINT Data Type, the length is the 1st and 2nd array index [0] & [1].

Send Test Message to ASCII:

Use this field to bypass the PLC and send a test message out to the ASCII device from the gateway. All delimiter information configured in the ASCII Configuration section will be applied when a message is sent.

- PLC and Port must be configured to use this feature.

Diagnostic Counters

Read ASCII Message from PLC:

OK: Increments with every read request for the length field from the gateway.

Error: Increments when there is an error with the Tag/File Name in the PLC.

Last Error: This will report the most recent error found.

Note: Errors that show up here are reported from either the 435NBX or the PLC. For detailed errors and explanations, please see [Appendix A](#).

Write Handshake Message to PLC:

OK: Increments with every successful message sent from PLC to the ASCII device.

Error: Increments when there is an error with the Tag/File Name in the PLC.

Last Error: This will report the most recent error found.

Note: Errors that show up here are reported from either the 435NBX or the PLC. For detailed errors and explanations, please see [Appendix A](#).

Diagnostics – Main Page

For a snapshot diagnostic view of the gateway, go to the Main Page. This page will automatically refresh.

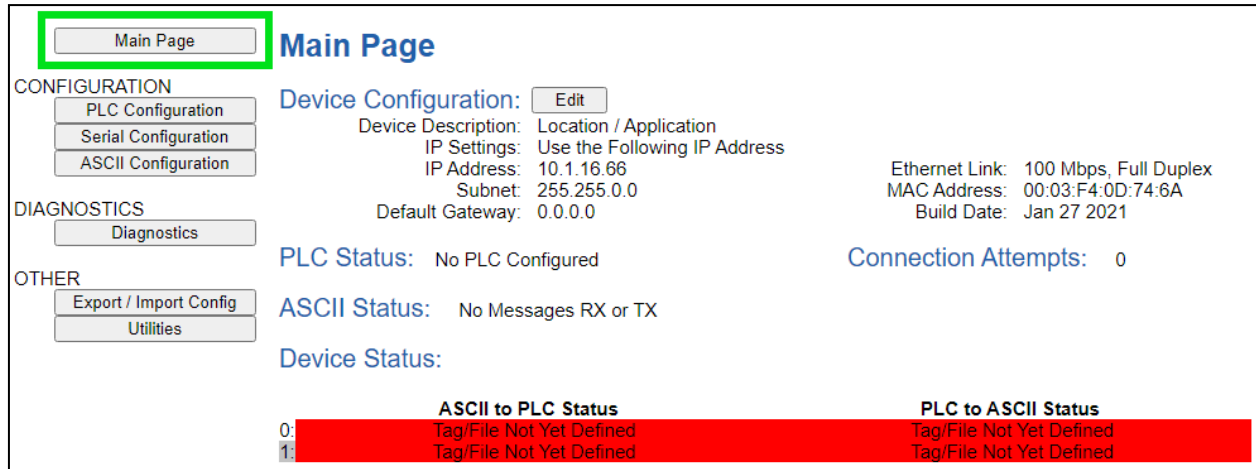

Main Page

CONFIGURATION

- PLC Configuration
- Serial Configuration
- ASCII Configuration

DIAGNOSTICS

- Diagnostics

OTHER

- Export / Import Config
- Utilities

Device Configuration:

Device Description: Location / Application
 IP Settings: Use the Following IP Address
 IP Address: 10.1.16.66
 Subnet: 255.255.0.0
 Default Gateway: 0.0.0.0

Ethernet Link: 100 Mbps, Full Duplex
 MAC Address: 00:03:F4:0D:74:6A
 Build Date: Jan 27 2021

PLC Status: No PLC Configured **Connection Attempts:** 0

ASCII Status: No Messages RX or TX

Device Status:

	ASCII to PLC Status	PLC to ASCII Status
0:	Tag/File Not Yet Defined	Tag/File Not Yet Defined
1:	Tag/File Not Yet Defined	Tag/File Not Yet Defined

PLC Status

This shows the Status of the PLC Connection. Possible values are:

- 1) No PLC Configured – Displays when either a PLC Type is not selected and/or the IP address is set to 0.0.0.0.
- 2) Connection Request Sent to PLC – Displays when a valid PLC Type and IP Address is configured and gateway is attempting to connect to the PLC.
- 3) Connection retry delay – Displays when a valid PLC Type and IP Address is configured and gateway tried to connect to the PLC but failed.
 - Verify the PLC Type, IP Address, Controller Slot, and Communication Mode to ensure information entered is correct.
 - Normally, Connection Attempts will also increment with this PLC Status.
- 4) I/O Adapter – Displays when PLC Type is selected to I/O Scanner

ASCII Status

This shows the overall status of the ASCII devices. Possible values are:

- 1) No Serial Port Configured – Displays when no ports are configured on the Serial Configuration page.
- 2) No Messages RX or TX – Displays when at least 1 port is configured and no ASCII messages have been successfully sent to the PLC or PLC messages sent to the ASCII device.
 - Verify the ASCII Configuration page is correct.

- 3) Queue Full – Discarding Messages – Displays when the buffer in the gateway is full and incoming messages are being discarded. This means the ASCII device is sending data faster than the PLC is clearing out the length field in the tag/register.

Device Status

There are 3 columns that make up this status. The status reflected here show the current status for configured parameters. This means that any pending changes made to that parameter since it was last powered up will not display.

Example: If since the last power up, the serial port has since been disabled, you will need to restart the gateway in order to see that port row disappear from the main page.

Device Status:		ASCII to CompactLogix Status	CompactLogix to ASCII Status
0:		0	Disabled
1:		0	3

- 1) Left column: The left most column indicates which port the status is for.
 - 0 – for Serial Port 0 on the gateway
 - 1 – for Serial Port 1 on the gateway
- 2) ASCII to PLC Status and PLC to ASCII Status columns: The two right columns break down the communication on that specific port by direction. Possible statuses are:
 - “Disabled” – Indicates that the direction on that port is not enabled.
 - “Tag/File Not Yet Defined” – Indicates that the port and direction are enabled, but the tag/file name is blank.
 - Only when PLC Type is not I/O Adapter
 - A decimal value – Represents number of complete messages that the gateway has received or the number of messages that we have received from the PLC and transmitted to the ASCII device.
- 3) Background colors:
 - White – Even row number with no errors for that port and direction.
 - Gray – Odd row number with no errors for that port and direction.
 - Read – Error for at least 1 of the reasons listed below:
 - i. PLC Type is not configured
 - ii. PLC Type is configured (not I/O Adapter) but IP address is 0.0.0.0
 - iii. Error Count on Diagnostics page is non-zero for that direction.

NOTE: The area will display with a red background if there are any errors listed on the diagnostics page, even if they are old. To remove this red background, go to the Diagnostics page for that port and direction and clear counters.

Save/Load the Configuration

Click the **Export/Import Config** button under the *OTHER* section.

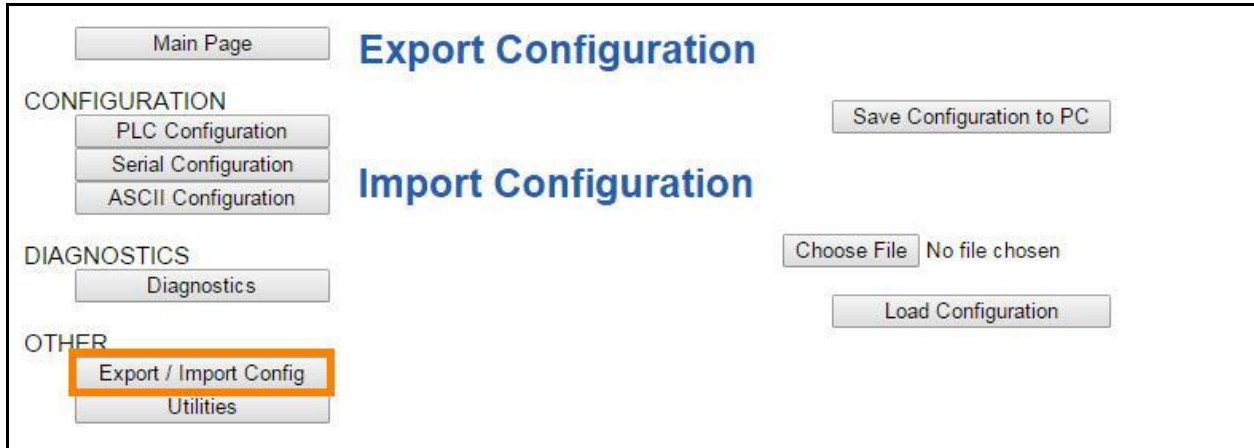

Export Configuration

- 1) Click the **Save Configuration to PC** button.
- 2) A prompt will then ask the type of file to save as. Any type will suffice.
- 3) This will save all of the configuration except for the Gateway's IP Network Settings, since this must be unique.
- 4) Save this file to the PC.

Import Configuration

- 1) Click **Choose File** and search for the configuration to load to the 435NBX.
- 2) Click **Load Configuration**. If successful, you will be redirected to the main page and be forced to reboot the gateway.
 - a. If the load failed, you will be prompted with an error.

Utilities

The Utilities screen offers additional features and functionality in the gateway including Logging, Security, Update Firmware Capability, and Restart Options.

Here you can also:

- Configure logging settings for diagnostic purposes.
- Configure security settings.
- Upgrade the firmware right from the webpage.
- Various options to reset the gateway.

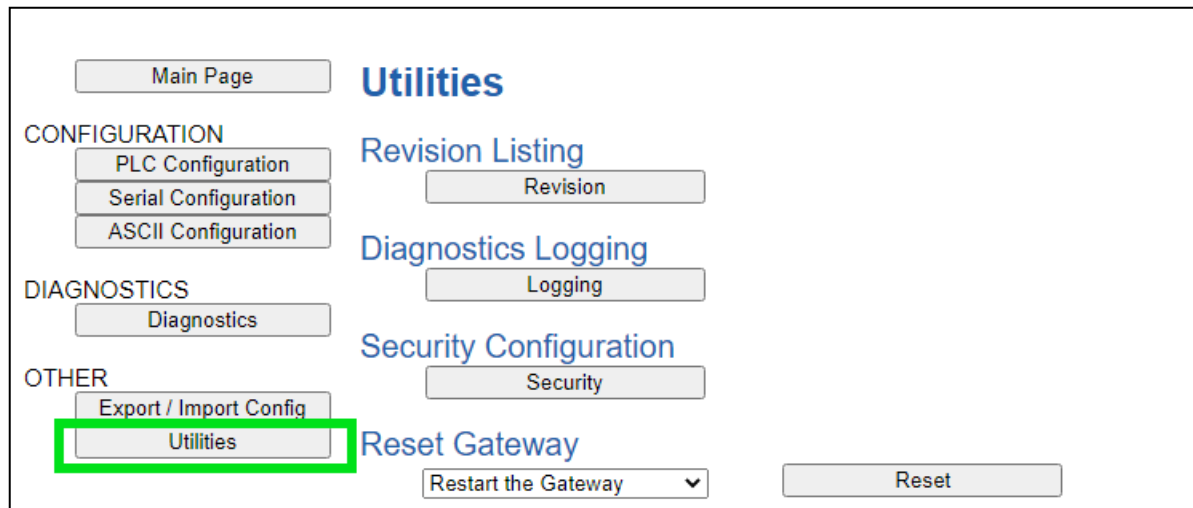

Revision Listing

Displays the full catalog number of the gateway. Have this number ready when contacting a RTA Technical Support Specialist.

Diagnostics Logging

Most users will not need to do anything with this feature. If there are problems with the gateway, a RTA Technical Support Specialist will direct you in how to use this feature.

Security Configuration

Click on the **Security** button to configure security for a single username and password.

- 1) Log Out Timer: The system will automatically log inactive users off after this period of time.
- 2) Username: Enter a username, max of 30 characters, case sensitive.
- 3) Password: Enter a password for the username, max of 30 characters, case sensitive.
- 4) Hint: A helpful reminder of what the password is.
- 5) Admin Information: Enter contact information in case username/password is forgotten.
- 6) Click the **Save Parameters** button to save.

Security

Log Out Timer: 1-60 min

Username:

Password:

Hint:

Admin Information:

Note: To disable security clear the username and password

Security - Log In

- 1) Username: Name of the user to login.
- 2) Password: Password of the user to login.
- 3) Log In: If login is successful, the user will be redirected to the Main Page.
- 4) Display Hint: Displays the hint specified for the user if one was set up.
- 5) Reset Password: This is used to reset security settings. Confirm reset password must be selected to confirm this action. Once confirmed, there is a 15 minute window to do a hard reset of the gateway by physically removing and restoring power from the gateway. Once power is restored, you may navigate to the IP address of the gateway as normal.

Security Log In

Username

Password

Hint: This is where your hint goes.

Admin Contact: Sample Admin Information here.

Reset Gateway

There are 3 options to reset the 435NBX.

- Restart the Gateway – Saves the current settings of the gateway and performs a software reboot.
- Reset to Last Powerup – Brings the device back to its last power up settings.
- Reset to Shipped Defaults – Brings the device back to its original manufacturing defaults, except for the IP Address.

Once an option is selected, click the **Reset** button to execute.

Save and Replace Configuration using SD Card

This function saves the gateway's configuration to an SD card. If the SD card is placed in another unit, the configuration on the SD card will automatically populate the gateway on power up.

This SD card replaces every configurable field in the gateway, **INCLUDING** IP Address, Subnet Mask, and Default Gateway.

Data Transfer To/From SD Card

Data is written **to** the SD card if no current configuration is found on the SD card and when a configuration change is saved.

Data is written **from** the SD card upon power up. If the SD card contains a configuration that differs in any way from the configuration already in the gateway the configuration from the SD card will be applied.

NOTE: When data is being written from the SD card to the gateway, it will take up to 30 seconds for the data transfer to be completed. During this time, the gateway cannot be accessed via the webpage.

Using IP Setup with SD Card

When an SD card is present and an IP address is modified through IPSetup.exe, a popup will appear after the **Set**→ button is pressed. This is intended as an extra precaution to ensure that the IP address should be modified from what is currently stored in the SD card.

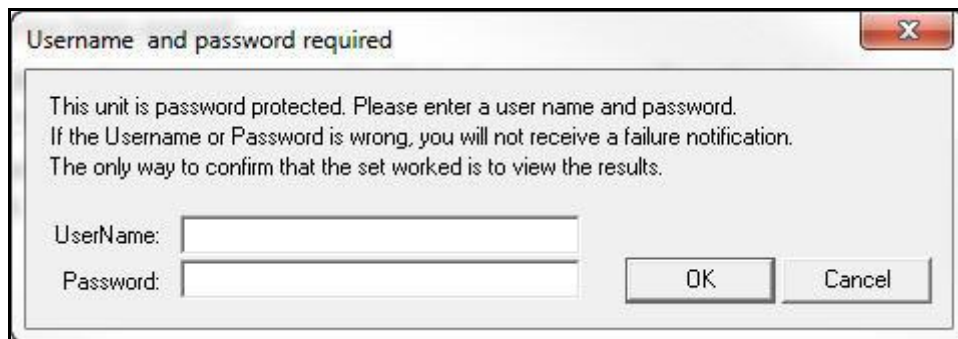

1. Enter a UserName of RTA.
2. Enter a Password of RTA.
3. Press OK.
4. This will then update the IP address of the gateway and the SD card with what was set through IPSetup.exe.

Appendix A: Error Definitions

Error	Status Name	Description
0x00	Success	Service was successful
0x01	Controller Slot Doesn't Exist	Connection related service failed along the connection path
0x02	Resource unavailable	Resources needed for the object requested service were unavailable
0x03	Invalid parameter value	See Error 0x20
0x04	Incorrect Tag Data Type Tag Name Doesn't Match (ext: 0000h)	Path segment identifier or the segment syntax was not understood by the processing node. Path processing will stop when a path segment error is encountered
0x05	Incorrect Controller Type	The path is referencing an object class, instance or structure element that is not known or is not contained in the processing node. Path processing will stop when a path destination unknown error is encountered
0x06	Partial transfer	Only part of the expected data was transferred
0x07	Connection Lost	The messaging connection was lost
0x08	Incorrect Controller Slot	The requested service was not implemented or was not defined for this object class/instance
0x09	Invalid attribute value	Invalid attribute data detected
0x0A	Attribute list error	An attribute in the Get_Attribute_List or Set_Attribute_List response has a non-zero status
0x0B	Already in requested mode / state	The object is already in the mode/state being requested by the service
0x0C	Object state conflict	The object cannot perform the requested service in its current mode/state
0x0D	Object already exists	The requested instance of object to be created already exists
0x0E	Attribute not settable	A request to modify a non-modifiable attribute was received

0x0F	Privilege violation	A permission/privilege check failed
0x10	Device state conflict	The device's current mode/state prohibits the execution of the requested service
0x11	Reply data too large	The data to be transmitted in the response buffer is larger than the allocated response buffer
0x12	Fragmentation of a primitive value	The service specified an operation that is going to fragment a primitive data value
0x13	Not enough data	The service did not supply enough data to perform the specified operation
0x14	Attribute not supported	The attribute specified in the request is not supported
0x15	Too much data	The service supplied more data than was expected
0x16	Object does not exist	The object specified does not exist in the device
0x17	Server fragmentation sequence	The fragmentation sequence for this service is not currently active for this data
0x18	No stored attribute data	The attribute data of this object was not saved prior to the requested service
0x19	Store operation failure	The attribute data of this object was not saved due to a failure during the attempt
0x1A	Routing failure, request packet too large	The service request packet was too large for transmission on a network in the path to the destination. The routing device was forced to abort the service
0x1B	Routing failure, response packet too large	The service response packet was too large for transmission on a network in the path from the destination. The routing device was forced to abort the service
0x1C	Missing attribute list entry data	The service did not supply an attribute in a list of attributes that was needed by the service to perform the requested behavior
0x1D	Invalid attribute value list	The service is returning the list of attributes supplied with status information for those attributes that were invalid

0x1E	Embedded server error	An embedded service resulted in an error: This can mean the Controller Slot, IP Address or Tag Name does not match. The Tag is not defined in the Controller Scope within the PLC, or the Tag does not have Read/Write privileges.
0x1F	Vendor specific error	A vendor specific error has been encountered. The Additional Code Field of the Error Response defines the particular error encountered. Use of this General Error Code should only be performed when none of the Error Codes presented in this table or within an Object Class definition accurately reflect the error
0x20	Invalid parameter	A parameter associated with the request was invalid. This code is used when a parameter does not meet the requirements of this specification and/or the requirements defined in an Application Object Specification
0x21	Write once value or medium already written	An attempt was made to write to a write-once medium that has already been written, or to modify a value that cannot be changed once established
0x22	Invalid reply received	An invalid reply is received. This status code can serve for other causes of invalid replies
0x23	Buffer Overflow	The message received is larger than the receiving buffer can handle. The entire message was discarded.
0x24	Message format error	The format of the received message is not supported by the server
0x25	Key failure in path	The key segment that was included as the first segment in the path does not match the destination module. The object specific status will indicate which part of the key check failed
0x26	Path size invalid	The size of the path which was sent with the Service Request is either not large enough for all the Requests to be routed to an object or too much routing data was included
0x27	Unexpected attribute	An attempt was made to set an attribute that is not able to be set at this time
0x28	Invalid member ID	The Member ID specified in the request does not exist in

the specified Class/Instance/Attribute

0x29 Member not settable

A request to modify a non-modifiable member was received

0x2C Attribute not gettable

A request to read a non-readable attribute was received

Appendix B: I/O Messaging - Configuration (Rev 7.03 or Later)

In order to enable I/O Messaging, under the PLC Type dropdown select I/O Scanner on the *PLC Configuration* page. Once you enable I/O Messaging, the Tag Name and Data Type in the **ASCII to PLC** and **PLC to ASCII** direction will not be used.

1. Set up the 435NBX as a Generic Ethernet Module into the Ethernet module I/O tree
2. Set the Data Format to "Data SINT"
3. Input Assembly: 100 (0x64) - Input Size: 416 Bytes
4. Output Assembly: 112 (0x70) - Output Size: 416 Bytes
5. Configuration Assembly: Any number (unused) - Configuration Size: 0 bytes

Input / Output Assembly Byte Breakdown

Input Assembly (ASCII to PLC) Port 0:

- Bytes 0-1: Output Handshake
- Bytes 2-3: Input Sequence Number
- Bytes 4-7: Input Length
- Bytes 8-207: Input Data (0-200 bytes)

Input Assembly (ASCII to PLC) Port 1:

- Bytes 208-209: Output Handshake
- Bytes 210-211: Input Sequence Number
- Bytes 212-215: Input Length
- Bytes 216-415: Input Data (0-200 bytes)

Output Assembly (PLC to ASCII) Port 0:

- Bytes 0-1: Input Handshake
- Bytes 2-3: Output Sequence Number
- Bytes 4-7: Output Length
- Bytes 8-207: Output Data (0-200 bytes)

Output Assembly (PLC to ASCII) Port 1:

- Bytes 208-209: Input Handshake
- Bytes 210-211: Output Sequence Number
- Bytes 212-215: Output Length
- Bytes 216-415: Output Data (0-200 bytes)

Input / Output Assembly Handshaking Breakdown

ASCII to PLC

The PLC monitors the Input Sequence Number for a non-zero value that doesn't match the Input Handshake. This indicates new data is ready for processing.

Upon receiving new data, the PLC reads the length of the data and processes it (up to 200 bytes). The PLC then echoes the Input Sequence Number into the Input Handshake. This is the indication to the 435NBX that the message was processed.

New messages from the 435NBX are only written to the PLC when the Input Sequence Number matches the Input Handshake. All other messages are queued in the 435NBX until the queue is full. Messages are then discarded based on the discard rules defined by the user.

The Sequence Number will roll over to 1 after 65535.

PLC to ASCII

If the Output Sequence Number matches the Output Handshake, the PLC can write a new message to the 435NBX.

The PLC must write the Output Length and Output Data first, then increment the Output Sequence Number.

Once the message is processed by the 435NBX, the Output Handshake is echoed with the Last Output Sequence Number.

Zero is an invalid value for the Output Sequence Number.

Input / Output Assembly Diagnostics Breakdown

When I/O Messaging is used, **only** the following counters or statuses are used on the Diagnostics page:

- The ASCII to PLC buffer display:
 - Last message sent to PLC
 - Next message stored in ASCII queue
 - Current message being processed
 - Send Test Message to PLC
 - ASCII Event counters
- PLC to ASCII buffer display:
 - Last message received from PLC
 - Send Test Message to ASCII

Appendix C: Create User Defined Tag in RSLogix 5000

- 1) Within RSLogix 5000, click on **Data Types** and select **Strings**.

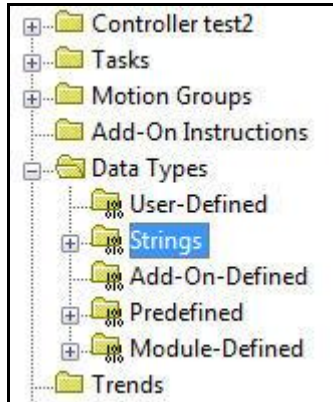

- 2) Right click on Strings and select **New String Type**. Give the new data type a name.
- 3) Select the max number of characters to be transferred.
- 4) When creating the tag name in the PLC, select the name of the new user defined data type you just created.

Appendix D: How to Access Program Scope Tags in RSLogix 5000

There are two different types of tags in the PLC: Controller Scope tags and Program Scope tags. With Controller Scope tags, these tag names can be entered into the gateway without any additional syntax. If you are using a tag that is defined within Program Scope, then the tag name inside of the RTA gateway needs additional syntax for it to successfully communicate.

EX: In the picture below, the Controller is set to “test2”.

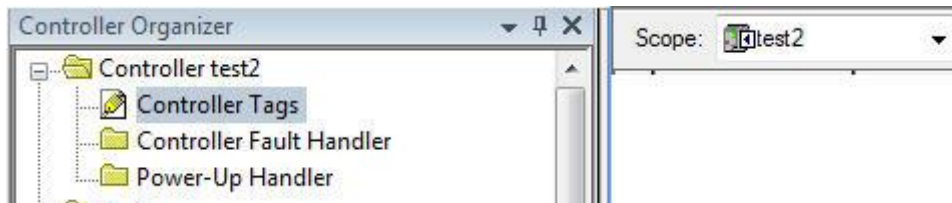

In the example below, the tag “AnotherTag” is setup in Program Scope named “AnotherProgram.” It is not setup in “test2” Controller Scope:

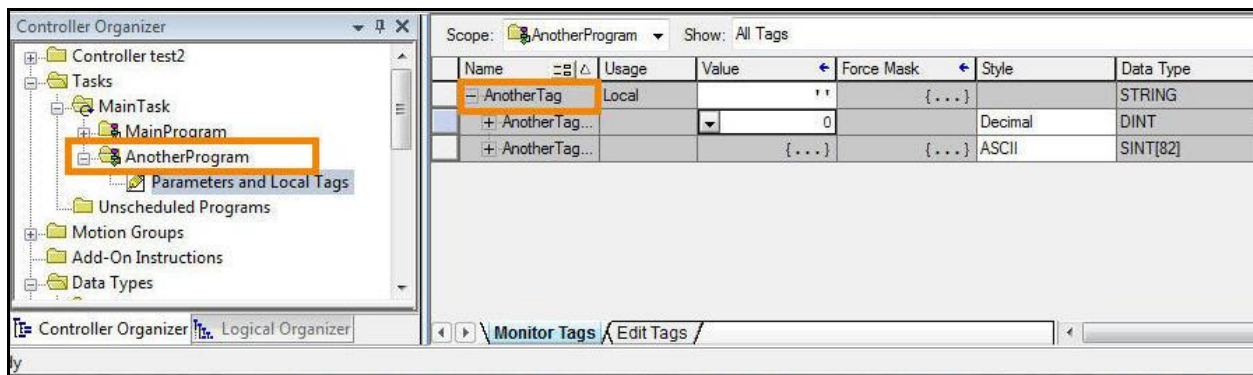

To access this tag “AnotherTag” in scope “AnotherProgram”, you need to enter it into the gateway using the following syntax:

Tag Name = “**PROGRAM:ProgramName.TagName**”

where *ProgramName* = Scope name & *TagName* = Actual Tag Name

In the previous example, it would be the following: “PROGRAM:AnotherProgram.AnotherTag”

Appendix E: Importing UDT_435NBX_Diagnostics.L5X

To import the UDT from the 435NBX’s webpage please follow these steps:

1. To download right click on the UDT_435NBX_Diagnostics.L5X hyperlink on the PLC Configuration page and select “save as” to download into your computer
2. To import into your RSLogix go into the Assets folder and expand the Data Types folder in the project tree. From here you can right click on User-Defined and select import and browse for that L5X file.
3. After importing L5X you can add a tag with the data type of the UDT_435NBX_Diagnostics for this example we used the tag name RTA435.
4. After creating your UDT tag your tag should look like this.

RTA435			UDT_435NBX_Diagnostics
▶ RTA435.Heartbeat			INT
▶ RTA435.Bit_Map_Status			INT
▶ RTA435.ASCII_Event_Delimiter			INT
▶ RTA435.ASCII_Event_Length			INT
▶ RTA435.ASCII_Event_Timeout			INT
▶ RTA435.ASCII_Event_Discards			INT