



This manual links to Kinetix 5300 Single-axis EtherNet/IP Servo Drives Fault Codes Reference Data, publication [2198-RD006](#), for fault codes. Download the spreadsheet now for offline access.



# Kinetix 5300 Single-axis EtherNet/IP Servo Drives

Catalog Numbers 2198-C1004-ERS, 2198-C1007-ERS, 2198-C1015-ERS, 2198-C1020-ERS, 2198-C2030-ERS, 2198-C2055-ERS, 2198-C2075-ERS, 2198-C4004-ERS, 2198-C4007-ERS, 2198-C4015-ERS, 2198-C4020-ERS, 2198-C4030-ERS, 2198-C4055-ERS, 2198-C4075-ERS



**Allen-Bradley**

by ROCKWELL AUTOMATION

User Manual

Original Instructions

## Important User Information

Read this document and the documents listed in the additional resources section about installation, configuration, and operation of this equipment before you install, configure, operate, or maintain this product. Users are required to familiarize themselves with installation and wiring instructions in addition to requirements of all applicable codes, laws, and standards.

Activities including installation, adjustments, putting into service, use, assembly, disassembly, and maintenance are required to be carried out by suitably trained personnel in accordance with applicable code of practice.

If this equipment is used in a manner not specified by the manufacturer, the protection provided by the equipment may be impaired.

In no event will Rockwell Automation, Inc. be responsible or liable for indirect or consequential damages resulting from the use or application of this equipment.

The examples and diagrams in this manual are included solely for illustrative purposes. Because of the many variables and requirements associated with any particular installation, Rockwell Automation, Inc. cannot assume responsibility or liability for actual use based on the examples and diagrams.

No patent liability is assumed by Rockwell Automation, Inc. with respect to use of information, circuits, equipment, or software described in this manual.

Reproduction of the contents of this manual, in whole or in part, without written permission of Rockwell Automation, Inc., is prohibited.

Throughout this manual, when necessary, we use notes to make you aware of safety considerations.



**WARNING:** Identifies information about practices or circumstances that can cause an explosion in a hazardous environment, which may lead to personal injury or death, property damage, or economic loss.

---



**ATTENTION:** Identifies information about practices or circumstances that can lead to personal injury or death, property damage, or economic loss. Attentions help you identify a hazard, avoid a hazard, and recognize the consequence.

---

**IMPORTANT** Identifies information that is critical for successful application and understanding of the product.

---

These labels may also be on or inside the equipment to provide specific precautions.



**SHOCK HAZARD:** Labels may be on or inside the equipment, for example, a drive or motor, to alert people that dangerous voltage may be present.

---



**BURN HAZARD:** Labels may be on or inside the equipment, for example, a drive or motor, to alert people that surfaces may reach dangerous temperatures.

---



**ARC FLASH HAZARD:** Labels may be on or inside the equipment, for example, a motor control center, to alert people to potential Arc Flash. Arc Flash will cause severe injury or death. Wear proper Personal Protective Equipment (PPE). Follow ALL Regulatory requirements for safe work practices and for Personal Protective Equipment (PPE).

---

The following icon may appear in the text of this document.



Identifies information that is useful and can help to make a process easier to do or easier to understand.

	<b>Preface</b> .....	9
	Summary of Changes.....	9
	Download Firmware, and Other Associated Files .....	9
	Conventions Used in This Manual .....	9
	Access Fault Codes .....	9
	CIP Security .....	10
	Additional Resources .....	10
	 <b>Chapter 1</b>	
<b>Start</b>	About the Kinetix 5300 Servo Drive System .....	14
	Drive Hardware and Input Power Configurations .....	15
	Motor and Auxiliary Feedback Configurations .....	18
	Typical Communication Configurations .....	19
	Linear Topology .....	19
	Ring Topology.....	20
	Star Topology .....	21
	Safe Torque Off Configuration .....	22
	Catalog Number Explanation .....	23
	Agency Compliance .....	24
	 <b>Chapter 2</b>	
<b>Plan the Kinetix 5300 Drive System Installation</b>	System Design Guidelines .....	25
	System Mounting Requirements .....	25
	AC Line Filter Selection .....	26
	Transformer Selection .....	27
	Circuit Breaker/Fuse Selection.....	27
	24V Control Power Evaluation .....	29
	Passive Shunt Considerations .....	30
	Enclosure Selection .....	31
	Minimum Clearance Requirements .....	33
	Electrical Noise Reduction .....	34
	HF Bond for Modules .....	34
	HF Bond for Multiple Subpanels .....	36
	Establish Noise Zones.....	37
	Cable Categories for Kinetix 5300 Systems .....	38
	Noise Reduction Guidelines for Drive Accessories .....	38
	 <b>Chapter 3</b>	
<b>Mount the Kinetix 5300 Drive System</b>	Determine Mounting Order.....	42
	Zero-stack Tab and Cutout .....	42
	Shared-bus Connection System.....	43
	Drill-hole Patterns .....	44
	Mount Your Kinetix 5300 Drive.....	50

<b>Connector Data and Feature Descriptions</b>	<b>Chapter 4</b>	
	Kinetix 5300 Connector Data . . . . .	52
	Safe Torque Off Connector Pinout . . . . .	52
	Input Power Connector Pinouts . . . . .	53
	Shunt Resistor Connector Pinouts . . . . .	53
	Ethernet Communication Connector Pinout . . . . .	53
	Digital Inputs and Auxiliary Feedback Connector Pinouts . . . . .	54
	Motor Power, Brake, and Feedback Connector Pinouts . . . . .	54
	Understand Control Signal Specifications . . . . .	56
	Digital Inputs . . . . .	56
	Motor Holding-brake Circuit . . . . .	56
	Control Power . . . . .	58
	Ethernet Communication Specifications . . . . .	58
	Feedback Specifications . . . . .	58
	Motor Feedback Supported on the MFB Connector . . . . .	59
	Auxiliary Feedback Specifications . . . . .	61
	Encoder Phasing Definitions . . . . .	63
	Absolute Position Feature . . . . .	64
	Safe Torque Off Safety Features . . . . .	65
	Servo Drives with Hardwired Safety . . . . .	65
	<b>Connect the Kinetix 5300 Drive System</b>	<b>Chapter 5</b>
Basic Wiring Requirements . . . . .		67
Build Your Own Cables . . . . .		68
Routing the Power and Signal Cables . . . . .		68
Determine the Input Power Configuration . . . . .		69
Three-phase Input Power . . . . .		69
Single-phase Input Power . . . . .		70
Ground the Drive System . . . . .		71
Ground the System Subpanel . . . . .		71
Ground Multiple Subpanels . . . . .		72
Wiring Requirements . . . . .		73
Wiring Guidelines . . . . .		75
Wire the Power Connectors . . . . .		76
Wire the 24V Control Power Input Connector . . . . .		76
Wire the Input Power Connector . . . . .		77
Wire the Digital Input Connectors . . . . .		77
Wire the Safe Torque Off Connector . . . . .		77
Wire the Digital Inputs and Auxiliary Feedback Connector . . . . .		78
Wire the Motor Power and Brake Connectors . . . . .		79
Servo Motor/Actuator and Cable Compatibility . . . . .		80
Motor Power and Brake Connections . . . . .		80
Maximum Cable Lengths . . . . .		82
Cable Preparation for Kinetix TLP Motor Power Cables . . . . .		83
Cable Preparation for 2090-CPxM7DF Motor Power Cables . . . . .		83
Cable Preparation for Kinetix TL and TLY Motor Power Cables . . . . .		86
Apply the Motor Power/brake Shield Clamp . . . . .		87
Wire the Motor Feedback Connector . . . . .		89
Cable Preparation for Kinetix TLP Feedback Cables . . . . .	90	

Cable Preparation for 2090-CFBM7Dx Feedback Cables . . . . .	90
Cable Preparation for Kinetix TL and TLY Feedback Cables . . . . .	91
Motor Feedback Cable Preparation . . . . .	92
Kinetix 2090 Feedback Cable Pinouts . . . . .	93
External Passive-shunt Resistor Connections . . . . .	96
Ethernet Cable Connections . . . . .	97

## Chapter 6

### Configure and Start Up the Kinetix 5300 Drive System

Understand the Kinetix 5300 Front Panel. . . . .	99
Menus and Display Screen. . . . .	100
Startup Sequence. . . . .	104
Configure the Kinetix 5300 Drive . . . . .	105
Set the Network Parameters . . . . .	105
Studio 5000 Logix Designer . . . . .	106
Version History . . . . .	106
Install the Kinetix 5300 Add-On Profile . . . . .	107
Configure the Logix 5000 Controller . . . . .	107
Configure the Kinetix 5300 Drive Modules . . . . .	110
Configure Drive Connections . . . . .	110
Continue Drive Configuration . . . . .	112
Configure the Motion Group . . . . .	115
Configure Vertical Load Control Axis Properties . . . . .	116
Configure Feedback-only Axis Properties . . . . .	116
Configure Induction-motor Frequency-control Axis Properties. . . . .	118
General and Motor Categories . . . . .	118
Basic Volts/Hertz Method . . . . .	119
Sensorless Vector Method . . . . .	119
Fan/Pump Volts/Hertz Method . . . . .	121
Configure SPM Motor Closed-loop Control Axis Properties . . . . .	122
Configure Induction-motor Closed-loop Control Axis Properties . . . . .	128
Configure Feedback Properties. . . . .	133
Configure Module Properties . . . . .	133
Configure Axis Properties . . . . .	134
Apply Power to the Kinetix 5300 Drive . . . . .	137
Test and Tune the Axes . . . . .	138
Test the Axes . . . . .	138
Tune the Axes . . . . .	140

## Chapter 7

### Troubleshoot the Kinetix 5300 Drive System

Safety Precautions . . . . .	141
Interpret Status Indicators. . . . .	141
Fault Code Overview . . . . .	142
Fault Codes . . . . .	143
Kinetix 5300 Drive Status Indicators . . . . .	143
General Troubleshooting . . . . .	144
Logix 5000 Controller and Drive Behavior . . . . .	145
Web Server Interface . . . . .	150

<b>Remove and Replace Servo Drives</b>	<b>Chapter 8</b>	
	Before You Begin .....	155
	Remove and Replace Kinetix 5300 Servo Drives .....	156
	Remove Power and All Connections .....	156
	Remove the Servo Drive .....	157
	Replace the Servo Drive .....	157
	Start and Configure the Drive .....	158
<b>Kinetix 5300 Safe Torque Off Function</b>	<b>Chapter 9</b>	
	Certification.....	159
	Important Safety Considerations .....	159
	Category 3 Requirements According to ISO 13849-1 .....	160
	Stop Category Definition .....	160
	Performance Level (PL) and Safety Integrity Level (SIL) .....	160
	Description of Operation .....	160
	Fault Codes .....	162
	Probability of Dangerous Failure Per Hour .....	164
	Safe Torque Off Connector Data.....	164
	Wire the Safe Torque Off Circuit .....	165
	Safe Torque Off Wiring Requirements.....	165
	Safe Torque Off Feature .....	166
	Safe Torque Off Feature Bypass .....	166
	Cascade the Safe Torque-off Signal.....	167
	STO Recovery Time .....	167
	Safe Torque Off Specifications .....	168
<b>Interconnect Diagrams</b>	<b>Appendix A</b>	
	Interconnect Diagram Notes .....	169
	Power Wiring Examples .....	170
	Shunt Resistor Wiring Example .....	172
	Kinetix 5300 Servo Drive and Rotary Motor Wiring Examples .....	173
	Kinetix 5300 Drive and Linear Actuator Wiring Examples.....	179
	System Block Diagrams.....	184
<b>Update Kinetix 5300 Drive Firmware</b>	<b>Appendix B</b>	
	Before You Begin .....	185
	Inhibit the Module.....	186
	Update Your Firmware .....	187
	Use ControlFLASH Plus Software to Update Your Drive Firmware .....	187
	Use ControlFLASH Software to Update Your Drive Firmware ...	191
	Verify the Firmware Update.....	195
<b>Motor Control Feature Support</b>	<b>Appendix C</b>	
	Frequency Control Methods.....	198
	Basic Volts/Hertz .....	199
	Basic Volts/Hertz for Fan/Pump Applications .....	200

Sensorless Vector .....	201
Current Limiting for Frequency Control .....	202
The Effects of Current Limiting .....	202
Enable the Current Limiting Feature .....	204
Set the CurrentVectorLimit Attribute Value .....	204
Stability Control for Frequency Control .....	205
Enable the Stability Control Feature .....	206
Skip Speeds .....	207
Multiple Skip Speeds .....	208
Flux Up .....	209
Flux Up Attributes .....	210
Configure the Flux Up Attributes .....	211
Current Regulator Loop Settings .....	212
Motor Category .....	212
Motor Tests and Autotune Procedure .....	214
Motor Analyzer Category Troubleshooting .....	215
Selection of Motor Thermal Models .....	218
Generic Motors .....	218
Rotary Motor Fan Cooling Attribute Information .....	219
Thermally Characterized Motors .....	220
Speed Limited Adjustable Torque (SLAT) .....	221
Motion Polarity Setting .....	221
SLAT Min Speed/Torque .....	221
SLAT Max Speed/Torque .....	222
SLAT Attributes .....	223
Configure the Axis for SLAT .....	223
Motion Drive Start (MDS) Instruction .....	226
Motor Overload Retention .....	231
Phase Loss Detection .....	232
Phase-loss Detection Configuration .....	233
Phase Loss Detection Current Example .....	234
Velocity Droop .....	234
Closed Loop Control .....	234
Frequency Control .....	235
Velocity Droop Attribute .....	235
Velocity Droop Configuration .....	235
Commutation Self-sensing Startup .....	236
Commutation Test .....	237
Adaptive Tuning .....	238
Virtual Torque Sensor .....	238

## Appendix D

### History of Changes

2198-UM005C-EN-P .....	239
------------------------	-----

<b>Index</b> .....	241
--------------------	-----

**Notes:**



This manual provides detailed installation instructions to mount, wire, and troubleshoot the Kinetix® 5300 servo drives, and system integration for your drive and motor/actuator combination with a Logix 5000® controller. This manual is intended for engineers or technicians that are directly involved in the installation and wiring of the Kinetix 5300 drives, and programmers that are directly involved in the operation, field maintenance, and integration of these drives with the EtherNet/IP™ communication module or controller.

If you do not have a basic understanding of Kinetix 5300 servo drives, contact your local Rockwell Automation sales representative for information on available training courses.

## Summary of Changes

This publication contains the following new or updated information. This list includes substantive updates only and is not intended to reflect all changes.

Topic	Page
Added UK certification where CE certification is mentioned.	Throughout <sup>(1)</sup>

(1) Locations are marked with change bars to the left of the changed text.

## Download Firmware, and Other Associated Files

Use the Product Compatibility and Download Center at [rok.auto/pcdc](http://rok.auto/pcdc) for the following:

- Download firmware and associated files such as Add-on Profile (AOP), Electronic Data Sheet (EDS), and Device Type Manager (DTM)
- Access product release notes

## Conventions Used in This Manual

These conventions are used throughout this manual:

- Bulleted lists such as this one provide information, not procedural steps.
- Numbered lists provide sequential steps or hierarchical information.

## Access Fault Codes



This manual links to Kinetix 5300 Single-axis EtherNet/IP Servo Drives Fault Codes Reference Data, publication [2198-RD006](#), for fault codes. Download the spreadsheet now for offline access.

## CIP Security

CIP Security™ is a standard, open-source communication method that helps to provide a secure data transport across an EtherNet/IP network. It lets CIP-connected devices authenticate each other before transmitting and receiving data.

CIP Security uses the following security properties to help devices protect themselves from malicious communication:

- Device Identity and Authentication
- Data Integrity and Authentication
- Data Confidentiality

Rockwell Automation uses the following products to implement CIP Security:

- FactoryTalk® Services Platform, version 6.11 or later, with the following components enabled:
  - FactoryTalk Policy Manager
  - FactoryTalk System Services
- FactoryTalk Linx, version 6.11 or later
- Studio 5000® Design Environment, version 32.00.00 or later
- CIP Security-enabled Rockwell Automation® products, for example, the product described in this publication

For more information on CIP Security, including which products support CIP Security, see the CIP Security with Rockwell Automation Products Application Technique, publication [SECURE-AT001](#).

## Additional Resources

These documents contain additional information concerning related products from Rockwell Automation. You can view or download publications at [rok.auto/literature](http://rok.auto/literature).

**Table 1 - Additional Resources**

Resource	Description
Kinetix Rotary Motion Specifications Technical Data, publication <a href="#">KNX-TD001</a>	Product specifications for Kinetix VPL, VPC, VPF, VPH, and VPS; Kinetix MPL, MPM, MPF, and MPS; Kinetix TLY and TL; Kinetix HPK; and Kinetix MMA rotary motors.
Kinetix Linear Motion Specifications Technical Data, publication <a href="#">KNX-TD002</a>	Product specifications for Kinetix MPAS and MPMA linear stages, Kinetix MPAR and MPAI electric cylinders, and Kinetix LDC and LDL linear motors.
Kinetix 5700, 5500, 5300, and 5100 Servo Drives Specifications Technical Data, publication <a href="#">KNX-TD003</a>	Provides product specifications for Kinetix Integrated Motion over the EtherNet/IP network and EtherNet/IP networking servo drive families.
Kinetix Rotary and Linear Motion Cable Specifications Technical Data, publication <a href="#">KNX-TD004</a>	Product specifications for Kinetix 2090 motor and interface cables.
Kinetix Servo Drive Performance Specifications per Ecodesign Regulation (EU) 2019/1781 Technical Data, publication <a href="#">KNX-TD006</a>	Provides energy efficiency performance data for Rockwell Automation Kinetix servo drives. This data supports IE2 compliance of Kinetix servo drives per EU 2019/1781.
Kinetix 5300 Single-axis EtherNet/IP Servo Drives Fault Codes Reference Data, publication <a href="#">2198-RD006</a>	Provides the fault codes for Kinetix 5300 single-axis EtherNet/IP servo drives.
AC Line Filter Installation Instructions, publication <a href="#">2198-IN003</a>	Provides information on how to install AC line filters designed for Kinetix 5300, Kinetix 5500, and Kinetix 5700 servo drive systems.
Shunt Resistor Installation Instructions, publication <a href="#">2097-IN002</a>	Provides information on how to install and wire Bulletin 2097 shunt resistors.
System Design for Control of Electrical Noise Reference Manual, publication <a href="#">GMC-RM001</a>	Information, examples, and techniques that are designed to minimize system failures caused by electromagnetic interference (EMI) sources.
Servo Drive Installation Best Practices Application Technique, publication <a href="#">MOTION-AT004</a>	Best practice examples to help reduce the number of potential noise or electromagnetic interference (EMI) sources in your system and to make sure that the noise sensitive components are not affected by the remaining noise.
Kinetix Motion Control Selection Guide, publication <a href="#">KNX-SG001</a>	Overview of Kinetix servo drives, motors, actuators, and motion accessories. The selection guide is designed to help make initial decisions for the motion control products best suited for your system requirements.
Kinetix 5300 Drive Systems Design Guide, publication <a href="#">KNX-RM012</a>	System design guide to select the required (drive specific) drive module, power accessory, feedback connector kit, and motor cable catalog numbers for your Kinetix 5300 servo drive system.

**Table 1 - Additional Resources (Continued)**

<b>Resource</b>	<b>Description</b>
Motor Nameplate Datasheet Entry for Custom Motor Applications Application Technique, publication <a href="#">2198-AT002</a>	Provides information on the use of nameplate data entry for custom induction motors and permanent-magnet motors that are used in applications with Kinetix 5700 servo drives.
Virtual Torque Sensor Application Technique, publication <a href="#">2198-AT003</a>	Provides information on the configuration and application of the virtual torque sensor capability of the Kinetix 5300 drives. The capability can be leveraged for analytics to improve the machine commissioning and maintenance experience.
Vertical Load and Holding Brake Management Application Technique, publication <a href="#">MOTION-AT003</a>	Provides information on vertical loads and how the servo motor holding-brake option can be used to help keep a load from falling.
Integrated Motion on the EtherNet/IP Network Reference Manual, publication <a href="#">MOTION-RM003</a>	Information on the AXIS_CIP_DRIVE attributes and the configuration software control modes and methods.
Integrated Motion on the EtherNet/IP Network Configuration and Startup User Manual, publication <a href="#">MOTION-UM003</a>	Information on how to configure and troubleshoot your ControlLogix® and CompactLogix™ EtherNet/IP network modules.
CIP Security with Rockwell Automation Products Application Technique, publication <a href="#">SECURE-AT001</a>	Provides information on CIP Security, including which Rockwell Automation products support CIP Security.
System Security Design Guidelines Reference Manual, <a href="#">SECURE-RM001</a>	Provides guidance on how to conduct security assessments, implement Rockwell Automation products in a secure system, harden the control system, manage user access, and dispose of equipment.
GuardLogix 5570 Controllers User Manual, publication <a href="#">1756-UM022</a>	Provides information on how to install, configure, program, and use ControlLogix® controllers and GuardLogix® controllers in Studio 5000 Logix Designer® projects.
GuardLogix 5580 Controllers User Manual, publication <a href="#">1756-UM543</a>	
Compact GuardLogix 5370 Controllers User Manual, publication <a href="#">1769-UM022</a>	Provides information on how to install, configure, program, and use CompactLogix™ and Compact GuardLogix controllers.
Compact GuardLogix 5380 Controllers User Manual, publication <a href="#">5069-UM001</a>	
GuardLogix 5570 and Compact GuardLogix 5370 Controller Systems Safety Reference Manual, publication <a href="#">1756-RM099</a>	Provides information on how to achieve and maintain Safety Integrity Level (SIL) and Performance Level (PL) safety application requirements for GuardLogix and Compact GuardLogix controllers.
GuardLogix 5580 and Compact GuardLogix 5380 Controller Systems Safety Reference Manual, publication <a href="#">1756-RM012</a>	
Rockwell Automation Product Selection website, <a href="http://rok.auto/systemtools">rok.auto/systemtools</a>	Online product selection and system configuration tools, including AutoCAD (DXF) drawings.
Motion Analyzer System Sizing and Selection Tool <a href="https://motionanalyzer.rockwellautomation.com/">https://motionanalyzer.rockwellautomation.com/</a>	Comprehensive motion application sizing tool used for analysis, optimization, selection, and validation of your Kinetix Motion Control system.
Product Certifications website, <a href="http://rok.auto/certifications">rok.auto/certifications</a>	Provides declarations of conformity, certificates, and other certification details.
ControlFLASH User Manual, publication <a href="#">1756-UM105</a>	Provides information on how to update your drive firmware by using ControlFLASH™ software.
Rockwell Automation Industrial Automation Glossary, publication <a href="#">AG-7.1</a>	A glossary of industrial automation terms and abbreviations.
Industrial Automation Wiring and Grounding Guidelines, publication <a href="#">1770-4.1</a>	Provides general guidelines for installing a Rockwell Automation industrial system.

---

**Notes:**

## Start

Use this chapter to become familiar with the Kinetix® 5300 drive system and obtain an overview of the installation configurations.

<b>Topic</b>	<b>Page</b>
About the Kinetix 5300 Servo Drive System	14
Drive Hardware and Input Power Configurations	15
Motor and Auxiliary Feedback Configurations	18
Typical Communication Configurations	19
Safe Torque Off Configuration	22
Catalog Number Explanation	23
Agency Compliance	24

## About the Kinetix 5300 Servo Drive System

The Kinetix 5300 servo drives are designed to provide a Kinetix Integrated Motion solution for your drive and motor/actuator application.

Table 2 - Kinetix 5300 Drive System Overview

Drive System Component	Cat. No.	Description
Kinetix 5300 Servo Drives	2198-Cxxxx-ERS	100V-class and 200V-class (single-phase or three-phase) and 400V-class (three-phase) drives operate in standalone configurations. Modules can be zero-stacked from drive-to-drive and are compatible with the 24V DC shared-bus connection system to extend control power to multiple drives. Drives feature Safe Torque Off via the hardwired (STO) connector.
24V Shared-bus Connector Kits	2198-TCON-24VDCIN36	Control power input connector for all frame sizes.
	2198-H040-x-x	Control power T-connector and busbar connectors for Frame 1 and 2 drives.
	2198-H070-x-x	Control power T-connector and busbar connectors for Frame 3 drives.
Feedback Connector Kit	2198-K53CK-D15M	Motor feedback connector kit with 15-pin connector plug for compatible motors and actuators. Kit features battery backup for Kinetix TLP, TL, and TLY multi-turn encoders.
Connector Sets	2198-CONKIT-PWR20	Connector set included with the Frame 1 and 2 drives (except 2198-C2030 drives). Replacement sets are also available.
	2198-CONKIT-PWR30	Connector set included with 2198-C2030 drives. Replacement sets are also available.
	2198-CONKIT-PWR75	Connector set included with Frame 3 drives. Replacement sets are also available.
Logix 5000 <sup>®</sup> Controller Platform	Bulletin 1769 Bulletin 5069	Integrated Motion on the EtherNet/IP™ network in CompactLogix™ 5370, CompactLogix 5380, and CompactLogix 5480 controllers and Integrated Safety in Compact GuardLogix <sup>®</sup> 5370 controllers. Linear, Device Level Ring (DLR), and Star Topology is supported.
	1756-EN2T module 1756-EN2TR module 1756-EN3TR module	EtherNet/IP network communication modules for use with ControlLogix <sup>®</sup> 5570, ControlLogix 5580, GuardLogix <sup>®</sup> 5570, and GuardLogix 5580 controllers. Linear, Device Level Ring (DLR), and Star Topology is supported.
	—	Studio 5000 Logix Designer <sup>®</sup> application, version 33.00 or later, provides support for programming, commissioning, and maintaining the CompactLogix and ControlLogix controller families.
Rotary Servo Motors	Kinetix MP	Compatible rotary motors include 200V and 400V-class Kinetix MPL, MPM, MPF, MPS servo motors.
	Kinetix TLP	Compatible rotary motors include 200V and 400V-class Kinetix TLP compact motors.
	Kinetix TL and TLY	Compatible rotary motors include 200V-class Kinetix TL and TLY servo motors.
Linear Actuators	Kinetix MP and Kinetix LDAT	Compatible linear actuators include 200V and 400V-class Kinetix MPAS and MPMA linear stages, Kinetix MPAR and MPAL linear actuators, and Kinetix LDAT linear thrusters.
Linear Motors	Kinetix LDC and Kinetix LDL	Compatible motors include Kinetix LDC iron-core and Kinetix LDL ironless linear motors.
Induction Motors	—	Induction motors with open-loop frequency control and closed-loop control are supported.
Kinetix 2090 Cables	2090-CTFB-MxDx-xxxxx	Motor feedback cables for Kinetix TLP motors.
	2090-CTPx-MxDx-xxxxx	Motor power/brake cables for Kinetix TLP motors.
	2090-CFBM6Dx-CxAxx	Motor feedback cables for Kinetix TLY servo motors.
	2090-CPxM6DF-16Axx	Motor power/brake cables for Kinetix TLY servo motors.
	2090-DANFCT-Sxx	Motor feedback cables for Kinetix TL servo motors.
	2090-DANPT-16Sxx	Motor power cables for Kinetix TL servo motors.
	2090-DANBT-18Sxx	Motor brake cables for Kinetix TL servo motors.
	2090-CFBM7DF-CEAxx	Motor feedback cables for Kinetix MP motors/actuators, Kinetix LDAT linear thrusters, and Kinetix LDC/Kinetix LDL linear motors.
	2090-CPxM7DF-xxAxx	Motor power/brake cables for Kinetix MP motors/actuators, Kinetix LDAT linear thrusters, and Kinetix LDC/Kinetix LDL linear motors.
	2090-XXNFMF-Sxx 2090-CFBM7DF-CDAFxx	Standard and continuous-flex feedback cables that include additional conductors for use with incremental encoders.
Ethernet Cables	1585J-M8CBJM-x 1585J-M8UBJM-x	Ethernet cables are available in standard lengths. Shielded cable is required to meet EMC specifications.
AC Line Filters	2198-DB08-F 2198-DBR20-F 2198-DBR40-F	Bulletin 2198 three-phase AC line filters are required to meet CE and UK and are available for use in all Kinetix 5300 drive systems.
24V DC Power Supply	1606-XLxxx	Bulletin 1606 24V DC power supply for control circuitry, digital inputs, and safety inputs.
External Shunt Resistors	2097-R6 and 2097-R7	Bulletin 2097 and 2198 external passive shunt resistors are available for when the internal shunt capability of the drive is exceeded.
	2198-R004, 2198-R014, 2198-R031	

# Drive Hardware and Input Power Configurations

Typical Kinetix 5300 systems include single-phase and three-phase standalone configurations.

In this example, a single drive is shown with input power to the standard AC and 24V DC input connectors.

**Figure 1 - Typical Kinetix 5300 Standalone Installation**

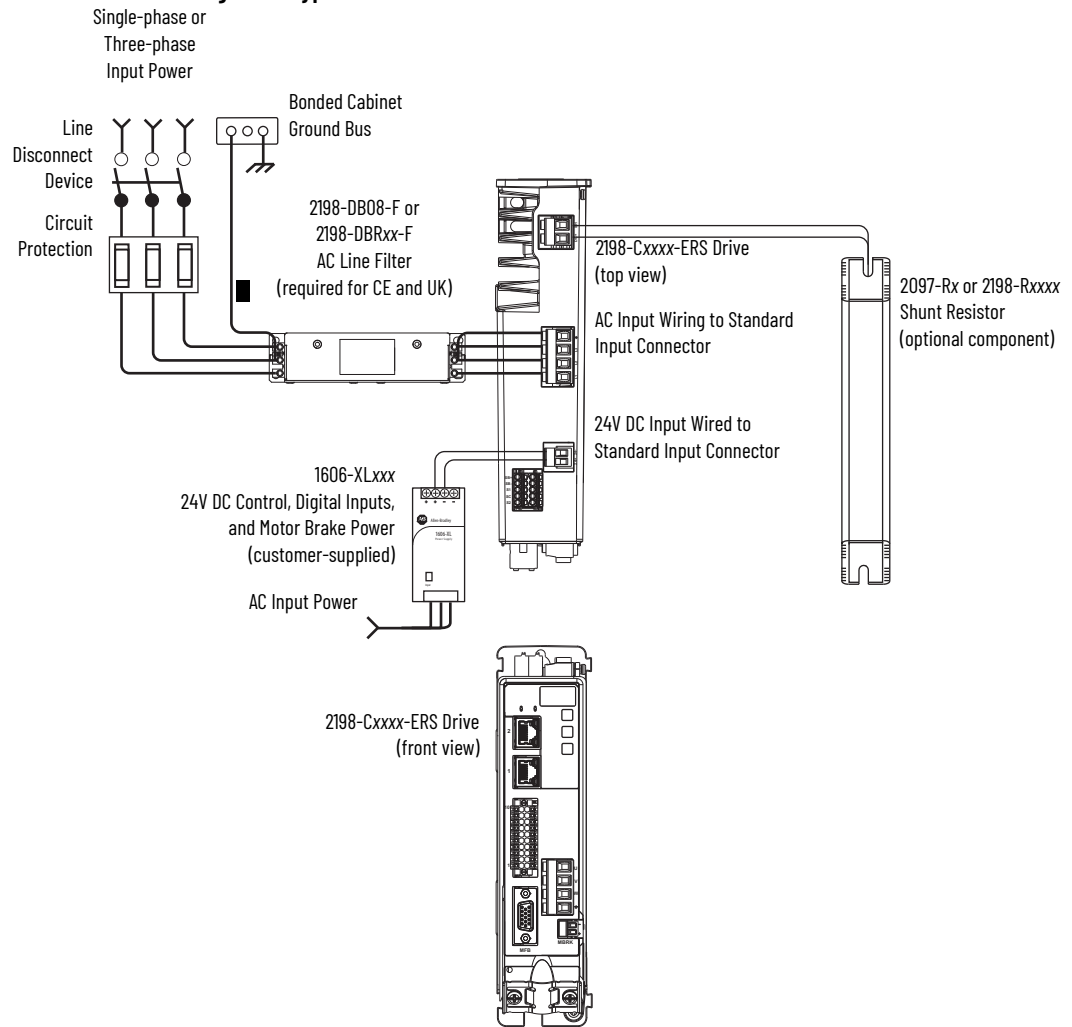

In this example, two drives are shown with input power to the standard input connectors and control power input by using 24V shared-bus connectors.

With two or more drives in the drive configuration, each drive requires AC input power and line filter.

**Figure 2 - Typical Kinetix 5300 Installation with 24V Shared-bus Connectors**

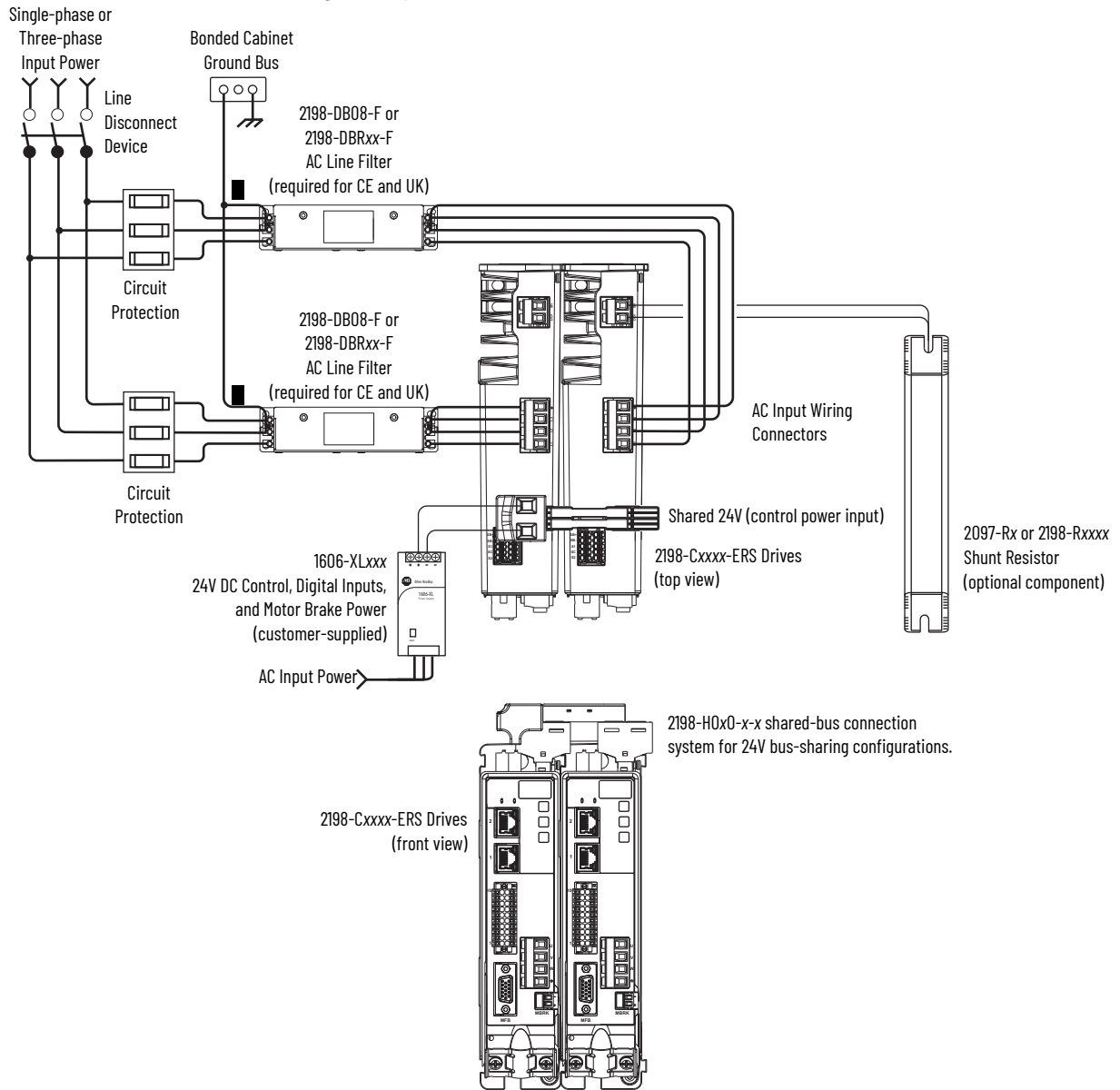



With two or more drives in the configuration and the 24V shared-bus connectors are not used, each drive requires 24V DC input power.

**Figure 3 - Typical Kinetix 5300 Installation without 24V Shared-bus Connectors**

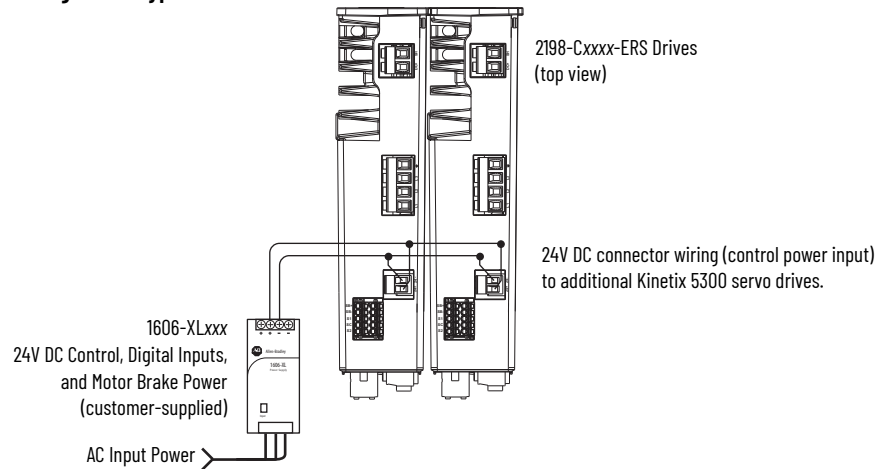

# Motor and Auxiliary Feedback Configurations

Feedback connections are made at the 15-pin motor feedback (MFB) connector and auxiliary feedback connector. These examples list the feedback types and illustrate the use of compatible rotary motors and linear products with motor cables and the 2198-K53CK-D15M connector kit. For motor power and brake connections, see [page 80](#).

Figure 4 - Feedback Configuration Examples

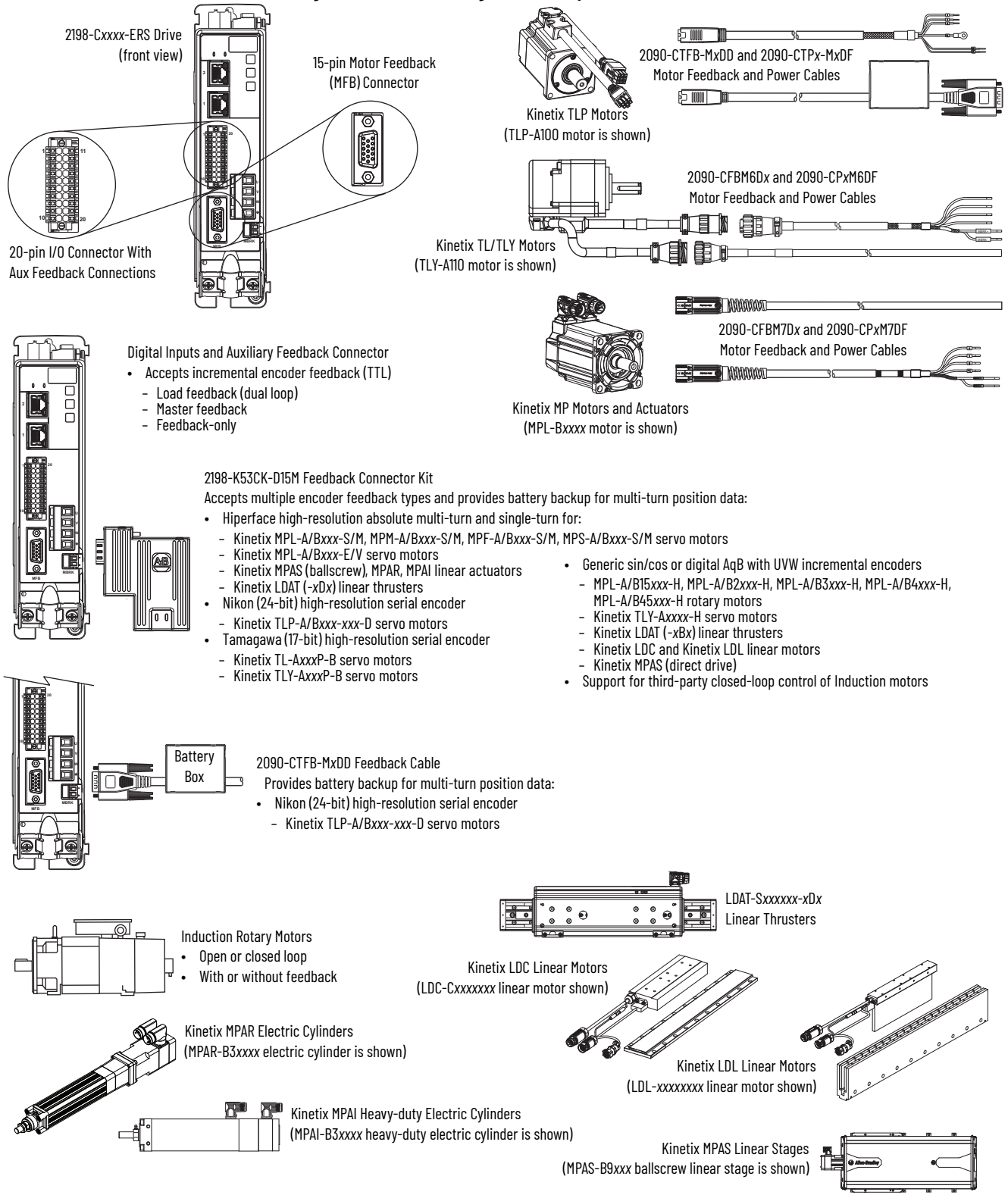

## Typical Communication Configurations

The Kinetix 5300 drives support any Ethernet topology including linear, ring, and star by using ControlLogix or CompactLogix controllers.

These examples feature the CompactLogix 5380 programmable automation controllers (Bulletin 5069) that are part of the Logix 5000 family of controllers. The applications range from standalone systems to more complex systems with devices that are connected to the controller via an EtherNet/IP™ network.

See CompactLogix 5380, Compact GuardLogix 5380, and CompactLogix 5480 Controller Specifications Technical Data, publication [5069-TD002](#), for more information on CompactLogix 5380 controllers.

### Linear Topology

In this example, all devices are connected in linear topology. The Kinetix 5300 drives include dual-port connectivity, however, if any device becomes disconnected, all devices downstream of that device lose communication. Devices without dual ports must include the 1783-ETAP module or be connected at the end of the line.

**Figure 5 - Kinetix 5300 Linear Communication Installation**

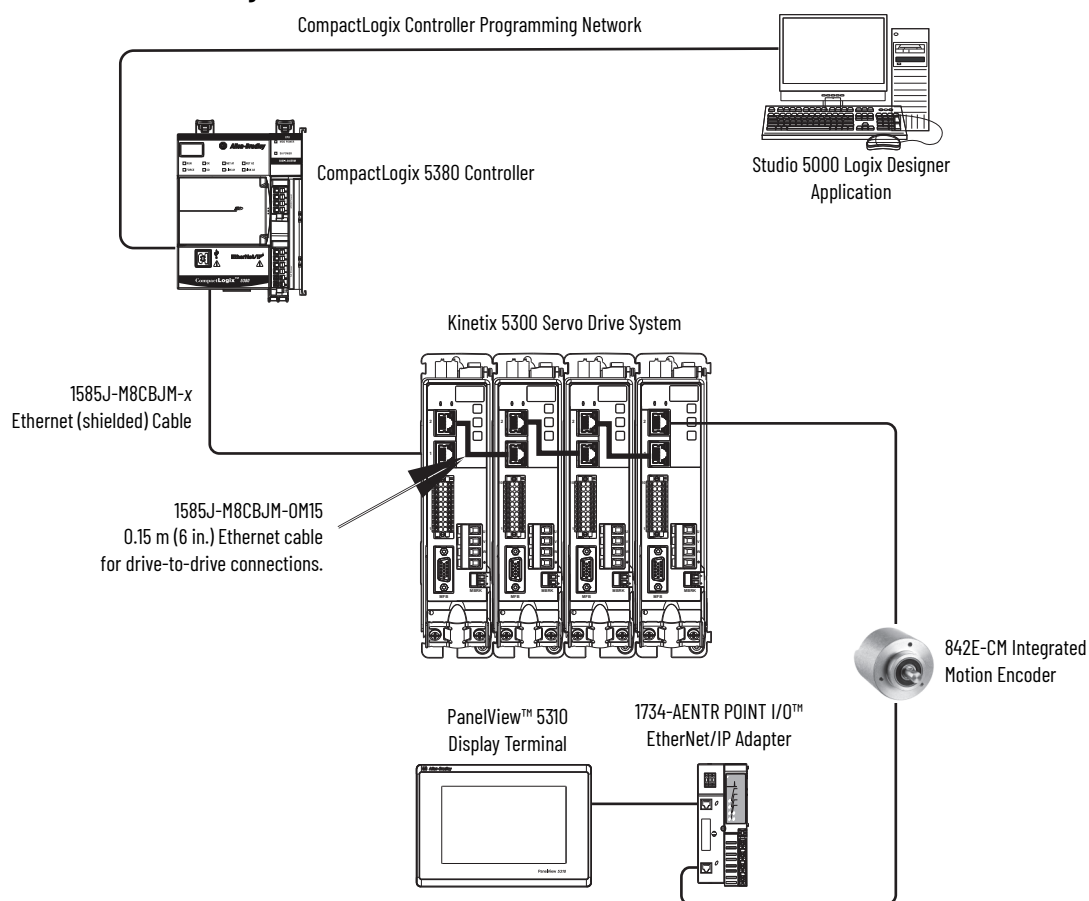

## Ring Topology

In this example, the devices are connected by using ring topology. If only one device in the ring is disconnected, the rest of the devices continue to communicate. For ring topology to work correctly, a Device Level Ring (DLR) supervisor is required (for example, the CompactLogix controller). DLR is an ODVA standard. For more information, see the EtherNet/IP Embedded Switch Technology Application Guide, publication [ENET-AP005](#).

Devices without dual ports require a 1783-ETAP module to complete the network ring.

**Figure 6 - Kinetix 5300 Ring Communication Installation**

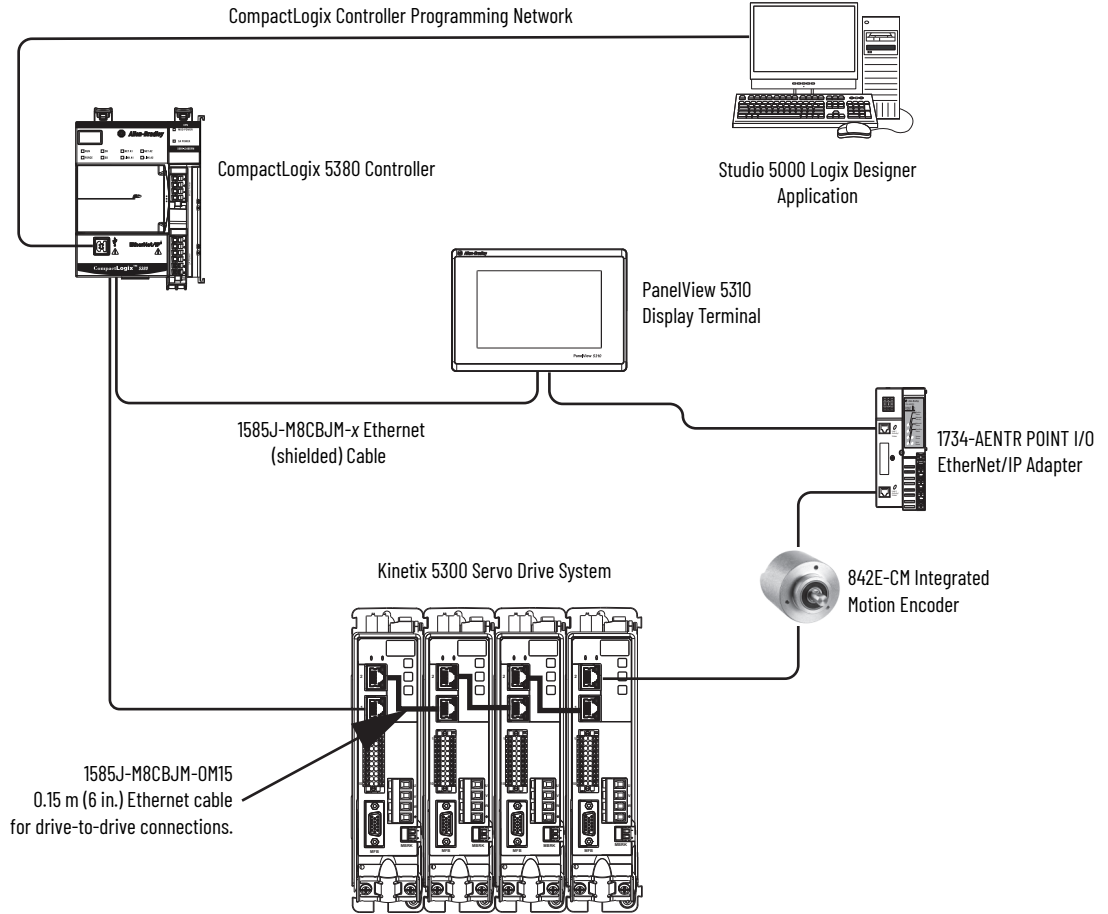

## Star Topology

In this example, the devices are connected by using star topology. Each device is connected directly to the switch.

Kinetix 5300 drives have dual ports, but in star topology all drives are connected to the switch, so the drives and other devices operate independently. The loss of one device does not impact the operation of other devices.

**Figure 7 - Kinetix 5300 Star Communication Installation**

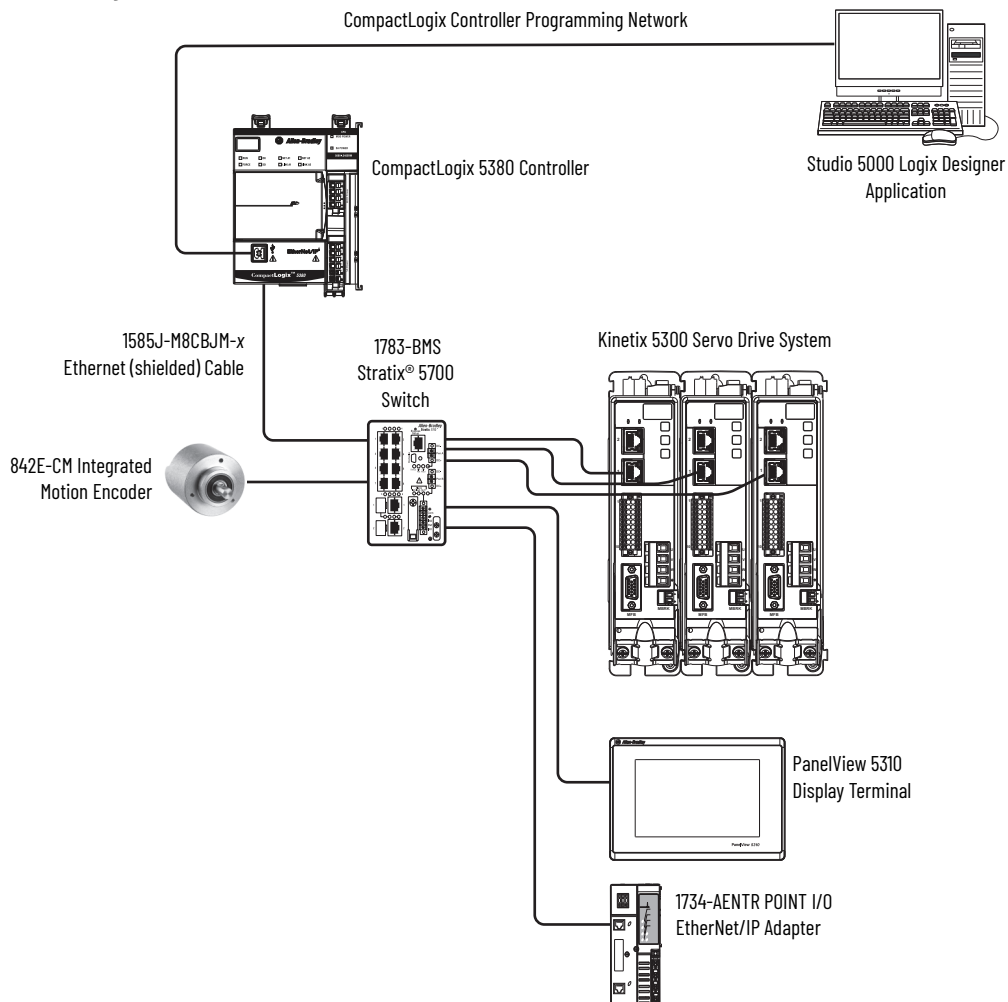

You can use the 842E-CM integrated motion encoder for applications that require an external encoder for gearing or camming to the Kinetix 5300 drive. By providing auxiliary feedback directly through the EtherNet/IP network, the 842E-CM encoder helps eliminate the need for point-to-point wiring while letting customers use the encoder in various network topologies. For more information, see the 842E-CM Integrated Motion on EtherNet/IP Product Profile, publication [842ECM-PP001](#).

# Safe Torque Off Configuration

The 2198-Cxxxx-ERS drives use the Safe Torque Off (STO) connector for wiring external safety devices and cascading hardwired safety connections from one drive to another.

**Figure 8 - Safe Torque Off (hardwired) Configuration**

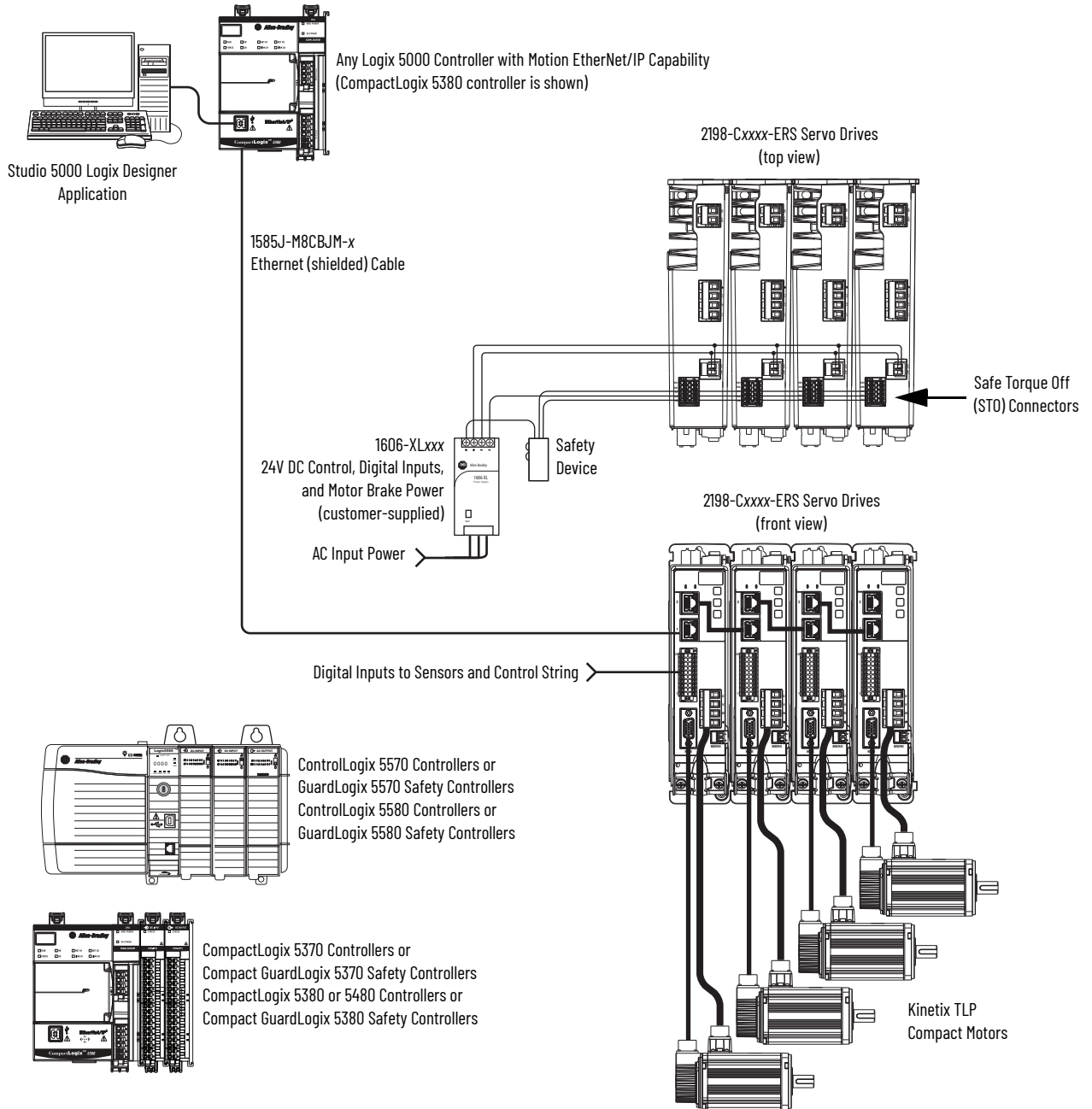

## Catalog Number Explanation

Kinetix 5300 drive catalog numbers and performance descriptions.

Table 3 - Kinetix 5300 Servo Drives

Drive Cat. No.	Frame Size	Input Voltage	Continuous Output Power kW	Continuous Output Current A (rms)	Peak Output Current A (rms)
2198-C1004-ERS	1	85...132V rms single-phase 170...253V rms single-phase 170...253V rms three-phase	0.22 0.46 0.72	2.8	6.6 9.5 9.5
2198-C1007-ERS	1		0.36 0.76 1.18	4.6	9.7 15.5 15.5
2198-C1015-ERS	2		0.67 1.41 2.18	8.5	12.2 20.5 29.2
2198-C1020-ERS	2		0.97 2.02 3.13	12.2	25.0 40.6 40.6
2198-C2030-ERS	2	170...253V rms three-phase	5.02	19.6	61.0
2198-C2055-ERS	3		10.30	40.2	108.0
2198-C2075-ERS	3		12.22	47.7	127.5
2198-C4004-ERS	1	342...528V rms three-phase	0.86	1.6	5.3
2198-C4007-ERS	1		1.55	2.9	9.3
2198-C4015-ERS	2		2.78	5.2	18.0
2198-C4020-ERS	2		3.90	7.3	23.8
2198-C4030-ERS	2		6.25	11.7	34.1
2198-C4055-ERS	3		12.08	22.6	58.5
2198-C4075-ERS	3		14.70	27.5	73.5

Table 4 - Shared-bus Connector Kit Catalog Numbers

Kit Cat. No.	Frame Size	Description
2198-TCON-24VDCIN36	1, 2, or 3	Control power input connector
2198-H040-P-T	1 or 2	<ul style="list-style-type: none"> <li>Control power T-connector</li> <li>Busbar connectors, quantity 2</li> </ul>
2198-H070-P-T	3	<ul style="list-style-type: none"> <li>Control power T-connector</li> <li>Busbar connectors, quantity 2</li> </ul>

Table 5 - Kinetix 5300 Servo Drive Accessories

Cat. No.	Description
2198-K53CK-D15M	15-pin motor-feedback connector kit.
2198-CONKIT-PWR20	Connector set included with the Frame 1 and 2 drives (except 2198-C2030 drives). Replacement sets are also available.
2198-CONKIT-PWR30	Connector set included with 2198-C2030 drives. Replacement sets are also available.
2198-CONKIT-PWR75	Connector set included with Frame 3 drives. Replacement sets are also available.

## Agency Compliance

If this product is installed within the European Union and has the CE marking, or within the United Kingdom and has the UKCA marking, the following regulations apply.



**ATTENTION:** The method of grounding the AC line filter and drive must match. Failure to make these grounding methods match renders the filter ineffective and can cause damage to the filter. For grounding examples, refer to [Determine the Input Power Configuration on page 69](#).

For more information on electrical noise reduction, refer to the System Design for Control of Electrical Noise Reference Manual, publication [GMC-RM001](#).

To comply with EN/IEC 61800-3 (category C3) and EN/IEC 61800-5-2, these requirements apply:

- Install an AC line filter (catalog numbers 2198-DBR20-F, 2198-DBR40-F, or 2198-DB08-F) with 50 mm (1.97 in.) minimum clearance between the drive and filter. Minimize the cable length as much as possible.
- Bond drive and line filter grounding screws by using a braided ground strap as shown in [Figure 36 on page 71](#).
- Use Kinetix 2090 motor power cables or use connector kits and connect the cable shields to the subpanel with the clamp that is provided.
- Use Kinetix 2090 motor feedback cables or use connector kits and properly connect the feedback cable shield.
- Drive-to-motor cables must not exceed 50 m (164 ft), depending on AC input power and feedback type. For specifications, see [Maximum Cable Lengths on page 82](#).
- Install the Kinetix 5300 system inside an enclosure. Run input power wiring in conduit (grounded to the enclosure) outside of the enclosure.
- Separate signal and power cables. Separate input power wiring and motor power cables from control wiring and motor feedback cables. Use shielded cable for power wiring and provide a grounded 360° clamp termination.

See [Appendix A on page 169](#) for input power wiring and drive/motor interconnect diagrams.



## Plan the Kinetix 5300 Drive System Installation

This chapter describes system installation guidelines that are used in preparation for mounting your Kinetix® 5300 drive components.

Topic	Page
System Design Guidelines	25
Electrical Noise Reduction	34



**ATTENTION:** Plan the installation of your system so that you can perform all cutting, drilling, tapping, and welding with the system removed from the enclosure. Because the system is of the open type construction, be careful to keep metal debris from falling into it. Metal debris or other foreign matter can become lodged in the circuitry and result in damage to the components.

### System Design Guidelines

Use the information in this section when designing your enclosure and planning to mount your system components on the panel.

For online product selection and system configuration tools, including AutoCAD (DXF) drawings of the product, see <https://www.rockwellautomation.com/en-us/support/product/product-selection-configuration.html>.

### System Mounting Requirements

- To comply with UL, CE, and UK certifications, the following requirements must be met:
  - The Kinetix 5300 drive systems must be enclosed in a grounded conductive enclosure.
  - The enclosure must offer protection as defined in standard EN/IEC 60529 to a protection class of IP20 or higher such that the Kinetix 5300 drive systems are not accessible to an operator or unskilled person.

A NEMA 4X enclosure exceeds these requirements, providing a protection class of IP66.
- To maintain the functional safety rating of the Kinetix 5300 drive system, this enclosure must be appropriate for the environmental conditions of the industrial location and provide a protection class of IP54 or higher.
- The panel that you install inside the enclosure for mounting your system components must be on a flat, rigid, vertical surface that is not subjected to shock or vibration. The panel installation surface must also not be exposed to moisture, oil mist, dust, or corrosive vapors in accordance with pollution degree 2 (EN/IEC 61800-5-1), because the product is rated to protection class IP20 (EN/IEC 60529). To comply with UL applications, cabinet ventilation is allowed on the left side and right side of the panel.

- Size the drive enclosure so as not to exceed the maximum ambient temperature rating. Consider the heat dissipation specifications for all drive components.
- Drive-to-motor cables must not exceed 50 m (164 ft), depending on input voltage and feedback type. For specifications, refer to [Maximum Cable Lengths on page 82](#).

---

**IMPORTANT** System performance was tested at these cable length specifications. These limitations also apply when meeting CE and UK requirements.

---

- Use high-frequency (HF) bonding techniques to connect the modules, enclosure, machine frame, and motor housing, and to provide a low-impedance return path for high-frequency (HF) energy and reduce electrical noise.

Bond drive and line filter grounding screws by using a braided ground strap as shown in [Figure 36 on page 71](#).

See the System Design for Control of Electrical Noise Reference Manual, publication [GMC-RM001](#), to better understand the concept of electrical noise reduction.

### AC Line Filter Selection

An AC line filter is required to meet CE and UK requirements. Install an AC line filter with 50 mm (1.97 in.) minimum clearance between the drive and filter. Minimize the cable length as much as possible.

**Table 6 - AC Line Filter Selection**

Drive Cat. No.	Frame Size	AC Line Filter Cat. No.
2198-C1004-ERS	1	2198-DB08-F
2198-C1007-ERS		
2198-C1015-ERS	2	2198-DBR20-F
2198-C1020-ERS		
2198-C2030-ERS		
2198-C2055-ERS	3	2198-DBR40-F
2198-C2075-ERS		
2198-C4004-ERS	1	2198-DB08-F
2198-C4007-ERS		
2198-C4015-ERS	2	2198-DBR20-F
2198-C4020-ERS		
2198-C4030-ERS		
2198-C4055-ERS	3	2198-DBR40-F
2198-C4075-ERS		

## Transformer Selection

The servo drive does not require an isolation transformer for three-phase input power. However, a transformer can be required to match the voltage requirements of the drive to the available service.

To size a transformer for the main AC power inputs, refer to the Kinetix 5300 power specifications in the Kinetix 5700, 5500, 5300, and 5100 Servo Drives Specifications Technical Data, publication [KNX-TD003](#).

---

**IMPORTANT** When using an autotransformer, make sure that the phase to neutral/ground voltage does not exceed the input voltage ratings of the drive.

---



---

**IMPORTANT** Use a form factor of 1.5 for three-phase power (where a form factor is used to compensate for transformer, drive module, and motor losses, and to account for utilization in the intermittent operating area of the torque speed curve).

---

Follow these guidelines when specifying the use of line reactors:

- For single-phase drives up to 138V line-to-line or line-to-neutral, a line reactor must be used if the source transformer is greater than 15 kVA, maximum and 3% impedance, minimum.
- For single-phase drives 170V...253V line-to-neutral or three-phase drives 170V...253V line-to-line, a line reactor must be used if the source transformer is greater than 75 kVA, maximum and 3% impedance, minimum.
- For three-phase drives 342V...528V line-to-line, a line reactor must be used if the source transformer is greater than 150 kVA, maximum and 3% impedance, minimum.

---

**EXAMPLE** Sizing a transformer to the power requirements of the drive:  
 2198-C2030-ERS = 5.02 kW x 1.5 = 7.53 KVA transformer (minimum)  
 2198-C4015-ERS = 2.78 kW x 1.5 = 4.17 KVA transformer (minimum)

---

See Kinetix 5700, 5500, 5300, and 5100 Servo Drives Specifications Technical Data, publication [KNX-TD003](#), for Kinetix 5300 drive specifications, including power ratings.

## Circuit Breaker/Fuse Selection

The Kinetix 5300 drives use internal solid-state motor short-circuit protection and, when protected by suitable branch circuit protection, are rated for use on a circuit capable of delivering up to 200,000 A (fuses, UL applications), 10,000 A (miniature circuit breakers), and 65,000 A (molded-case circuit breakers).

For the wiring diagram, refer to [Power Wiring Examples on page 170](#).



**ATTENTION:** Do not use circuit protection devices on the output of an AC drive as an isolating disconnect switch or motor overload device. These devices are designed to operate on sine wave voltage and the drive's PWM waveform does not allow it to operate properly. As a result, damage to the device occurs.

---

**Table 7 - Kinetix 5300 UL/CSA Circuit Protection Specifications**

Drive Cat. No.	AC Input Voltage, Nom	Phase	Bussmann Fuses Cat. No.	Molded Case CB Cat. No.
2198-C1004-ERS	200...240V AC	Three phase	KTK-R-6	140U-D6D3-B40 and 140UT-D7D3-B40
2198-C1007-ERS			KTK-R-10	140U-D6D3-B80 and 140UT-D7D3-B80
2198-C1015-ERS			KTK-R-15	140U-D6D3-C12 and 140UT-D7D3-C12
2198-C1020-ERS			KTK-R-25	140U-D6D3-C20 and 140UT-D7D3-C20
2198-C2030-ERS			KTK-R-30	140U-D6D3-C30 and 140UT-D7D3-C30
2198-C2055-ERS			LPJ-50SP	140G-G6C3-C50
2198-C2075-ERS			LPJ-60SP	140G-G6C3-C60
2198-C4004-ERS	380...480V AC	Three phase	KTK-R-3	140U-D6D3-B20 and 140UT-D7D3-B20
2198-C4007-ERS			KTK-R-6	140U-D6D3-B40 and 140UT-D7D3-B40
2198-C4015-ERS			KTK-R-12	140U-D6D3-B80 and 140UT-D7D3-B80
2198-C4020-ERS			KTK-R-15	140U-D6D3-C12 and 140UT-D7D3-C12
2198-C4030-ERS			KTK-R-25	140U-D6D3-C15 and 140UT-D7D3-C15
2198-C4055-ERS			LPJ-30SP	140U-D6D3-C30 and 140UT-D7D3-C30
2198-C4075-ERS			LPJ-35SP	140U-D6D3-C30 and 140UT-D7D3-C30
2198-C1004-ERS	100...120V AC	Single-phase	KTK-R-6	140U-D6D2-B40 and 140UT-D7D2-B40
2198-C1007-ERS			KTK-R-10	140U-D6D2-B80 and 140UT-D7D2-B80
2198-C1015-ERS			KTK-R-15	140U-D6D2-C12 and 140UT-D7D2-C12
2198-C1020-ERS			KTK-R-25	140U-D6D2-C20 and 140UT-D7D2-C20
2198-C1004-ERS	200...240V AC	Single-phase	KTK-R-6	140U-D6D2-B40 and 140UT-D7D2-B40
2198-C1007-ERS			KTK-R-10	140U-D6D2-B80 and 140UT-D7D2-B80
2198-C1015-ERS			KTK-R-15	140U-D6D2-C12 and 140UT-D7D2-C12
2198-C1020-ERS			KTK-R-25	140U-D6D2-C20 and 140UT-D7D2-C20

**Table 8 - Kinetix 5300 IEC (non-UL/CSA) Circuit Protection Specifications**

Drive Cat. No.	AC Input Voltage, Nom	Phase	DIN gG Fuses Amps, max	Miniature CB Cat. No.	Molded Case CB Cat. No.
2198-C1004-ERS	200...240V AC	Three phase	6	1489-M3C060	140U-D6D3-B40 and 140UT-D7D3-B40
2198-C1007-ERS			10	1489-M3C100	140U-D6D3-B80 and 140UT-D7D3-B80
2198-C1015-ERS			16	1489-M3C160	140U-D6D3-C12 and 140UT-D7D3-C12
2198-C1020-ERS			25	1489-M3C250	140U-D6D3-C20 and 140UT-D7D3-C20
2198-C2030-ERS			32	1489-M3C400	140U-D6D3-C30 and 140UT-D7D3-C30
2198-C2055-ERS			40	—	140G-G6C3-C50
2198-C2075-ERS			50	—	140G-G6C3-C60
2198-C4004-ERS	380...480V AC	Three phase	2	1489-M3C030	140U-D6D3-B20 and 140UT-D7D3-B20
2198-C4007-ERS			6	1489-M3C060	140U-D6D3-B40 and 140UT-D7D3-B40
2198-C4015-ERS			12	1489-M3C100	140U-D6D3-B80 and 140UT-D7D3-B80
2198-C4020-ERS			16	1489-M3C130	140U-D6D3-C12 and 140UT-D7D3-C12
2198-C4030-ERS			25	1489-M3C200	140U-D6D3-C15 and 140UT-D7D3-C15
2198-C4055-ERS			32	1489-M3C350	140U-D6D3-C30 and 140UT-D7D3-C30
2198-C4075-ERS			32	1489-M3C400	140U-D6D3-C30 and 140UT-D7D3-C30
2198-C1004-ERS	100...120V AC or 200...240V AC	Single-phase	6	1489-M2C060	140U-D6D2-B40 and 140UT-D7D2-B40
2198-C1007-ERS			10	1489-M2C100	140U-D6D2-B80 and 140UT-D7D2-B80
2198-C1015-ERS			16	1489-M2C160	140U-D6D2-C12 and 140UT-D7D2-C12
2198-C1020-ERS			25	1489-M2C250	140U-D6D2-C20 and 140UT-D7D2-C20

## 24V Control Power Evaluation

The Kinetix 5300 drive system requires 24V DC input for its control circuitry. Due to the 24V shared-bus connection system and the 24V current requirements of the Kinetix 5300 drives, a thorough evaluation of control power is required before implementation. Consider the following when sizing such a system:

- Verify that the 24V DC power supply is capable of supplying the 24V current requirements of your Kinetix 5300 drive system. To determine the 24V current requirements, see [Control Power on page 58](#).  
For systems with a high 24V current demand, consider installing a separate 24V power supply for each drive to more evenly divide the 24V current demand.
- Verify that the wiring being used is capable of supplying the Kinetix 5300 drive system with a voltage within the 24V input-voltage range; 24V  $\pm$ 10% (21.6...26.4V DC). Consider the following:
  - Mount the 24V power supply as close to the Kinetix 5300 drive system as possible to minimize input voltage drop.
  - Install larger gauge wire, up to 2.5 mm<sup>2</sup> (14 AWG) for 24V control power when using the connector plugs included with the module; or use the 24V shared-bus connection system to lower the DC wire resistance with up to 10 mm<sup>2</sup> (6 AWG) and result in a lower voltage drop.
- For best practices of twisting 24V wires and routing cleanly, refer to the System Design for Control of Electrical Noise Reference Manual, publication [GMC-RM001](#).

---

**IMPORTANT** The 24V current demand, wire gauge, and wire length all impact the voltage drop across the wiring being used.

---

## Passive Shunt Considerations

The Kinetix 5300 drives include an internal shunt that is wired to the shunt resistor connector at the factory. Bulletin 2097-Rx and 2198-Rxxxx external passive shunts are also available to provide additional shunt capacity for applications where the internal shunt capacity is exceeded.

**IMPORTANT** Keep the internal shunt connected unless you have an external passive shunt to connect.

Table 9 - Passive-shunt Options

Drive Cat. No.	Internal Shunt Specifications		Bulletin 2198 External Shunt Module (1) Cat. No.			Bulletin 2097 External Shunt Module (1) Cat. No.	
	Ω	W	2198-R004	2198-R014	2198-R031	2097-R6	2097-R7
2198-C1004-ERS	100	30	—	—	—	X	X
2198-C1007-ERS			—	—	—	X	X
2198-C1015-ERS	60	50	X	—	X	X	X
2198-C1020-ERS			X	—	X	X	X
2198-C2030-ERS			X	—	X	X	X
2198-C2055-ERS	40	75	X	X	X	X	X
2198-C2075-ERS			X	X	X	X	X
2198-C4004-ERS	100	30	—	—	—	X	X
2198-C4007-ERS			—	—	—	X	X
2198-C4015-ERS	60	50	X	—	X	X	X
2198-C4020-ERS			X	—	X	X	X
2198-C4030-ERS			X	—	X	X	X
2198-C4055-ERS	40	75	X	X	X	X	X
2198-C4075-ERS			X	X	X	X	X

(1) Shunt resistor selection is based on the needs of your actual hardware configuration.

Catalog numbers 2198-R014 and 2198-R031 are composed of resistor coils that are housed inside an enclosure. Catalog numbers 2097-R6, 2097-R7, and 2198-R004 are shunt resistors without an enclosure.

Figure 9 - External Passive Shunts

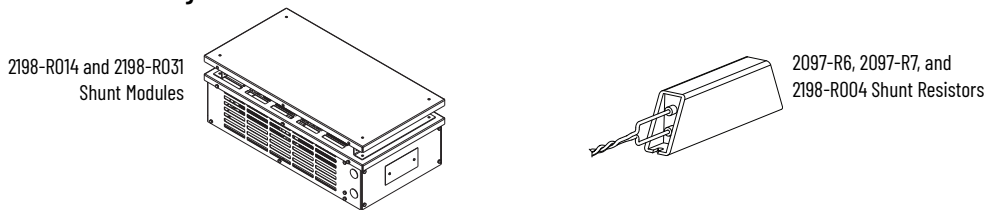

**ATTENTION:** See [Table 10](#) for supported shunt modules. Using an unsupported shunt module can lead to (drive-side) shunt circuitry damage, shunt damage, or drive faults.

Table 10 - External Shunt Module Specifications

Shunt Module Cat. No.	Resistance Ohms	Continuous Power W	Weight, Approx kg (lb)
2097-R6	75	150	0.3 (0.7)
2097-R7	150	80	0.2 (0.4)
2198-R004	33	400	1.8 (4.0)
2198-R014	9.4	1400	9.1 (20)
2198-R031	33	3100 <sup>(1)</sup>	16.8 (37)

(1) The 2198-R031 shunt is limited to 2000 W when used with 2198-C1015-ERS, 2198-C1020-ERS, 2198-C2030-ERS, 2198-C4015-ERS, 2198-C4020-ERS, 2198-C4030-ERS (frame 2) drives.

How the Bulletin 2097-Rx and 2198-Rxxx shunts connect to the Kinetix 5300 drive is explained in [External Passive-shunt Resistor Connections on page 96](#) and illustrated with interconnect diagrams in [Shunt Resistor Wiring Example on page 172](#).

## Enclosure Selection

This example is provided to assist you in sizing an enclosure for your Kinetix 5300 drive system. You need heat dissipation data from all components that are planned for your enclosure to calculate the enclosure size (refer to [Table 11 on page 32](#)).

**IMPORTANT** To comply with UL requirements, the minimum cabinet size must be 508 mm (20.0 in.), height; 406 mm (16.0 in.), width; and 300 mm (11.8 in.) depth.

With no active method of heat dissipation (such as fans or air conditioning), either of the following approximate equations can be used.

Metric	Standard English
$A = \frac{0.38Q}{1.8T - 1.1}$	$A = \frac{4.08Q}{T - 1.1}$
Where T is the temperature difference between inside air and outside ambient (°C), Q is heat that is generated in enclosure (Watts), and A is enclosure surface area (m <sup>2</sup> ). The exterior surface of all six sides of an enclosure is calculated as follows:	Where T is the temperature difference between inside air and outside ambient (°F), Q is heat that is generated in enclosure (Watts), and A is enclosure surface area (ft <sup>2</sup> ). The exterior surface of all six sides of an enclosure is calculated as follows:
$A = 2dw + 2dh + 2wh$	$A = (2dw + 2dh + 2wh) / 144$
Where d (depth), w (width), and h (height) are in meters.	

If the maximum ambient rating of the Kinetix 5300 drive system is 50 °C (122 °F) and if the maximum environmental temperature is 20 °C (68 °F), then T=30. In this example, the total heat dissipation is 416 W (sum of all components in the enclosure). So, in the equation below, T=30 and Q=416.

$$A = \frac{0.38 (416)}{1.8 (30) - 1.1} = 2.99 \text{ m}^2$$

In this example, the enclosure must have an exterior surface of at least 2.99 m<sup>2</sup>. If any portion of the enclosure is not able to transfer heat, do not include that value in the calculation.

Because the minimum cabinet depth to house the Kinetix 5300 system (selected for this example) is 300 mm (11.8 in.), the cabinet must be approximately 1500 x 700 x 300 mm (59.0 x 27.6 x 11.8 in.) H x W x D.

$$1.5 \times (0.300 \times 0.70) + 1.5 \times (0.300 \times 2.0) + 1.5 \times (0.70 \times 2.0) = 3.31 \text{ m}^2$$

Because this cabinet size is considerably larger than what is necessary to house the system components, it can be more efficient to provide a means of cooling in a smaller cabinet. Contact your cabinet manufacturer for options available to cool your cabinet.

Table 11 - Power Dissipation Specifications

Kinetix 5300 Drive Cat. No.	AC Input, Nom	Usage as a % of Rated Power Output <sup>(1)</sup> (watts)				
		20%	40%	60%	80%	100%
2198-C1004-ERS	200...240V three-phase	12	16	20	25	29
2198-C1007-ERS		14	19	24	30	37
2198-C1015-ERS		26	36	47	59	71
2198-C1020-ERS		35	52	71	91	112
2198-C2030-ERS		53	87	124	164	206
2198-C2055-ERS		87	139	193	250	308
2198-C2075-ERS		97	159	225	293	364
2198-C4004-ERS	380...480V three-phase	16	21	26	31	36
2198-C4007-ERS		20	30	39	48	58
2198-C4015-ERS		33	48	62	78	93
2198-C4020-ERS		39	58	79	101	124
2198-C4030-ERS		57	89	123	157	193
2198-C4055-ERS		112	171	231	293	356
2198-C4075-ERS		134	204	273	344	417
2198-C1004-ERS	100...120V single-phase	11	14	18	22	26
2198-C1007-ERS		12	17	21	27	32
2198-C1015-ERS		23	32	42	53	64
2198-C1020-ERS		30	44	59	77	96
2198-C1004-ERS	200...240V single-phase	12	16	20	25	30
2198-C1007-ERS		14	19	24	30	37
2198-C1015-ERS		25	36	47	59	72
2198-C1020-ERS		35	52	72	92	115

(1) Internal shunt power is not included in the calculations and must be added based on utilization.



## Minimum Clearance Requirements

This section provides information to assist you in sizing your cabinet and positioning your Kinetix 5300 drive:

- Additional clearance is required for cables and wires or the 24V DC shared-bus connection system that is connected to the top of the drive.
- Additional clearance is required if other devices are installed above and/or below the drive and have clearance requirements of their own.
- Additional clearance left and right of the drive is required when mounted next to noise sensitive equipment or clean wireways.

**Figure 10 - Minimum Clearance Requirements**

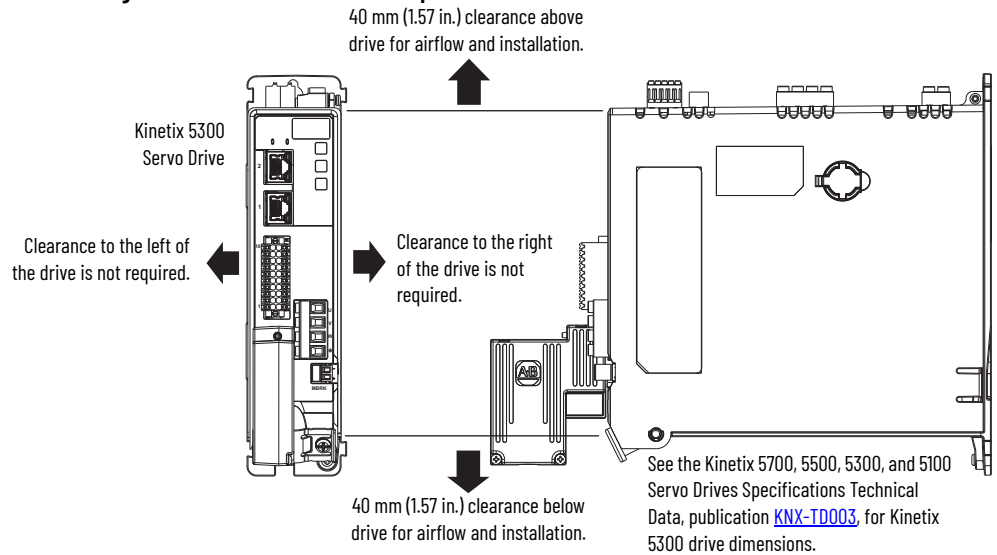

**IMPORTANT** Mount the drive in an upright position as shown to provide proper airflow.

In 24V shared-bus configurations (optional), drives must be spaced by aligning the zero-stack tab and cutout. Install the AC line filter (required for CE and UK) with 50 mm (1.97 in.) minimum clearance between the drive and filter, or between filters when multiple filters are used. Minimize the cable length as much as possible.

**Figure 11 - 24V Shared-bus and Line Filter Clearance Requirements**

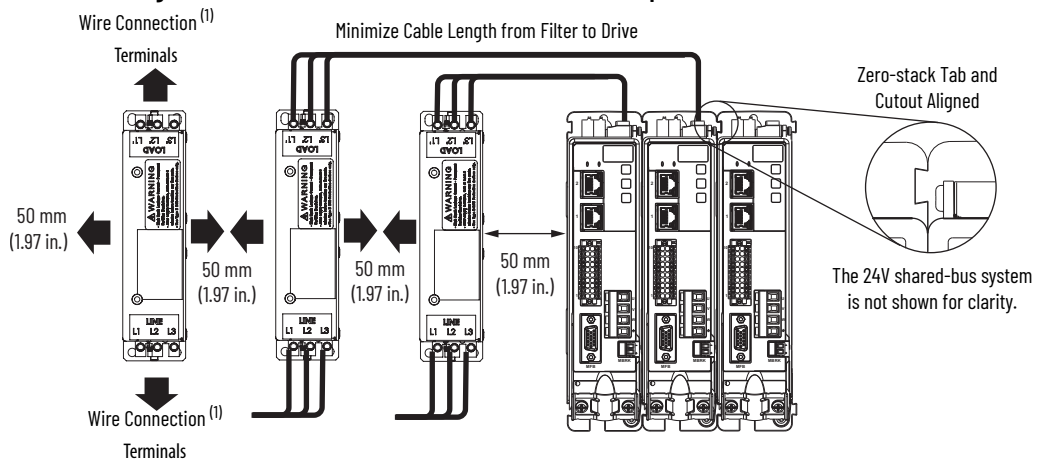

(1) The clearance that is required at the terminals for NEC specified bend radius depends on the wire size that is used.

## Electrical Noise Reduction

This section outlines best practices that minimize the possibility of noise-related failures as they apply specifically to Kinetix 5300 system installations. For more information on the concept of high-frequency (HF) bonding, the Ground Plane principle, and electrical noise reduction, refer to the System Design for Control of Electrical Noise Reference Manual, publication [GMC-RM001](#).

### HF Bond for Modules

Bonding is the practice of connecting metal chassis, assemblies, frames, shields, and enclosures to reduce the effects of electromagnetic interference (EMI).

Unless specified, most paints are not conductive and act as insulators. To achieve a good bond between the power rail and the subpanel, surfaces must be paint-free or plated. Bonding metal surfaces creates a low-impedance return path for high-frequency energy.

---

**IMPORTANT** To improve the bond between the power rail and subpanel, construct your subpanel out of zinc-plated (paint-free) steel.

---

Improper bonding of metal surfaces blocks the direct return path and allows high-frequency energy to travel elsewhere in the cabinet. Excessive high-frequency energy can affect the operation of other microprocessor-controlled equipment.

These illustrations show details of recommended bonding practices for painted panels, enclosures, and mounting brackets.

**Figure 12 - Recommended Bonding Practices for Painted Panels**

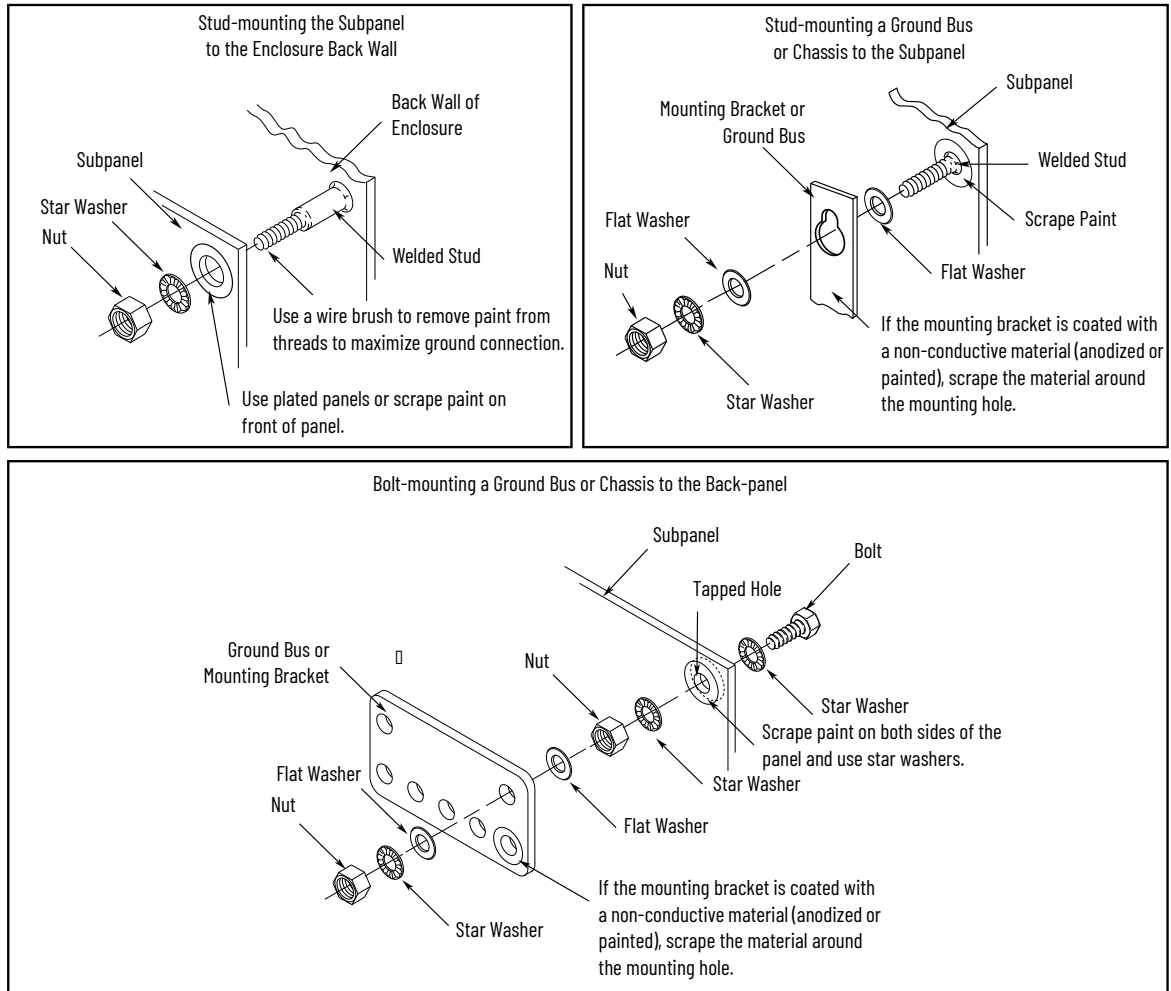

## HF Bond for Multiple Subpanels

Bonding multiple subpanels creates a common low impedance exit path for the high-frequency energy inside the cabinet. Subpanels that are not bonded together do not necessarily share a common low impedance path. This difference in impedance can affect networks and other devices that span multiple panels:

- Bond the top and bottom of each subpanel to the cabinet by using 25.4 mm (1.0 in.) by 6.35 mm (0.25 in.) wire braid. As a rule, the wider and shorter the braid is, the better the bond.
- Scrape the paint from around each fastener to maximize metal-to-metal contact.

Figure 13 - Multiple Subpanels and Cabinet Recommendations

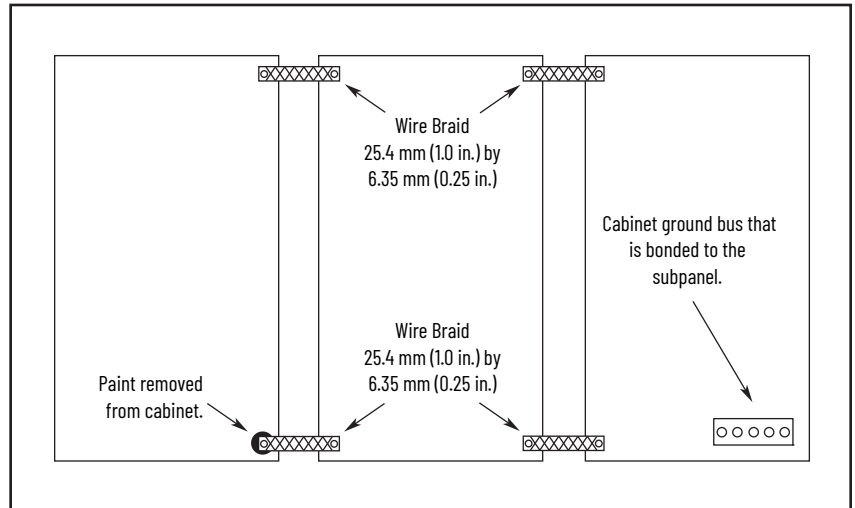

## Establish Noise Zones

Observe these guidelines when routing cables used for Kinetix 5300 drives:

- The clean zone (C) is right of the drive system and includes the feedback cables, digital inputs wiring, and Ethernet cable (gray wireway).
- The dirty zone (D) is above and below the drive system (black wireways) and includes the circuit breakers, 24V DC power supply, safety, and motor power cables.
- The very dirty zone (VD) is limited to where the AC line (EMC) filter VAC output jumpers over to the drive (or the first drive when two or more drives are zero-stacked together). Shielded cable is required only if the very dirty cables enter a wireway. Keep filter wiring as short as possible.

Figure 14 - Noise Zones

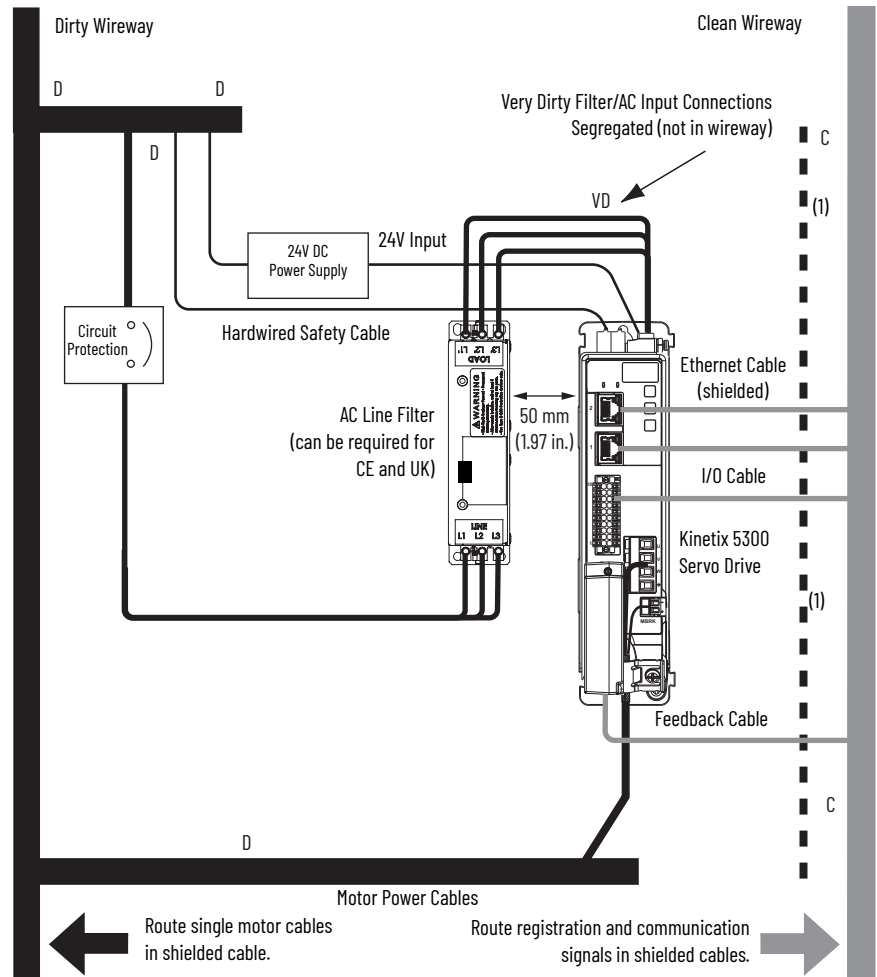

- (1) When space to the right of the drive does not permit 150 mm (6.0 in.) separation, use a grounded steel shield instead. For examples, refer to the System Design for Control of Electrical Noise Reference Manual, publication [GMC-RM001](#).

## Cable Categories for Kinetix 5300 Systems

These tables indicate the zoning requirements of cables connecting to the Kinetix 5300 drive components.

Table 12 - Kinetix 5300 Drive

Wire/Cable	Connector Function	Zone			Method	
		Very Dirty	Dirty	Clean	Ferrite Sleeve	Shielded Cable
L1, L2, L3 (shielded cable)	AC input power	—	X	—	—	X
L1, L2, L3 (unshielded cable)		X	—	—	—	—
DC+/SH (shunt)	Shunt resistor	—	X	—	—	—
U, V, W	Motor power	—	X	—	—	X
Motor feedback (15-pin)	Motor feedback (MFD)		—	X		X
Motor brake	Motor brake		X	—		X
Control power (24V DC)	Power for control logic, Safe Torque Off, and motor holding brake.	—	X	—	—	—
Safety enable for Safe Torque Off	Safe Torque Off (STO)	—	X	—	—	—
Digital I/O	Registration input	—	—	X	—	X
	Other dedicated digital inputs	—	X	—	—	—
	Auxiliary feedback	—	—	X	—	X
Ethernet	PORT1 PORT2	—	—	X	—	X

## Noise Reduction Guidelines for Drive Accessories

Use this section when mounting an AC (EMC) line filter or external passive-shunt resistor, for guidelines that are designed to reduce system failures caused by excessive electrical noise.

### AC Line Filters

Observe these guidelines when mounting your AC (EMC) line filter (refer to the figure on [page 37](#) for an example):

- Mount the AC line filter on the same panel as the Kinetix 5300 drive with 50 mm (1.97 in.) minimum clearance between the drive and filter. Minimize the cable length as much as possible.
- Good HF bonding to the panel is critical. For painted panels, refer to the examples on [page 35](#).
- Separate input and output wiring as far as possible.

---

**IMPORTANT** CE and UK test certification applies to only the AC line filter used with a single drive. Multiple drives sharing a line filter can perform satisfactorily, but the customer takes legal responsibility. See System Design for Control of Electrical Noise Reference Manual, publication [GMC-RM001](#), for more information.

---

### External Passive Shunt Resistor

Observe these guidelines when mounting your Bulletin 2097 or Bulletin 2198 external passive-shunt resistor outside of the enclosure:

- Mount the shunt resistor and wiring in the very dirty zone or in an external shielded enclosure.
- Mount the resistors in a shielded and ventilated enclosure outside of the cabinet.
- Keep unshielded wiring as short as possible. Keep the shunt wiring as flat to the cabinet as possible.

**Figure 15 - External Shunt Resistor Outside the Enclosure**

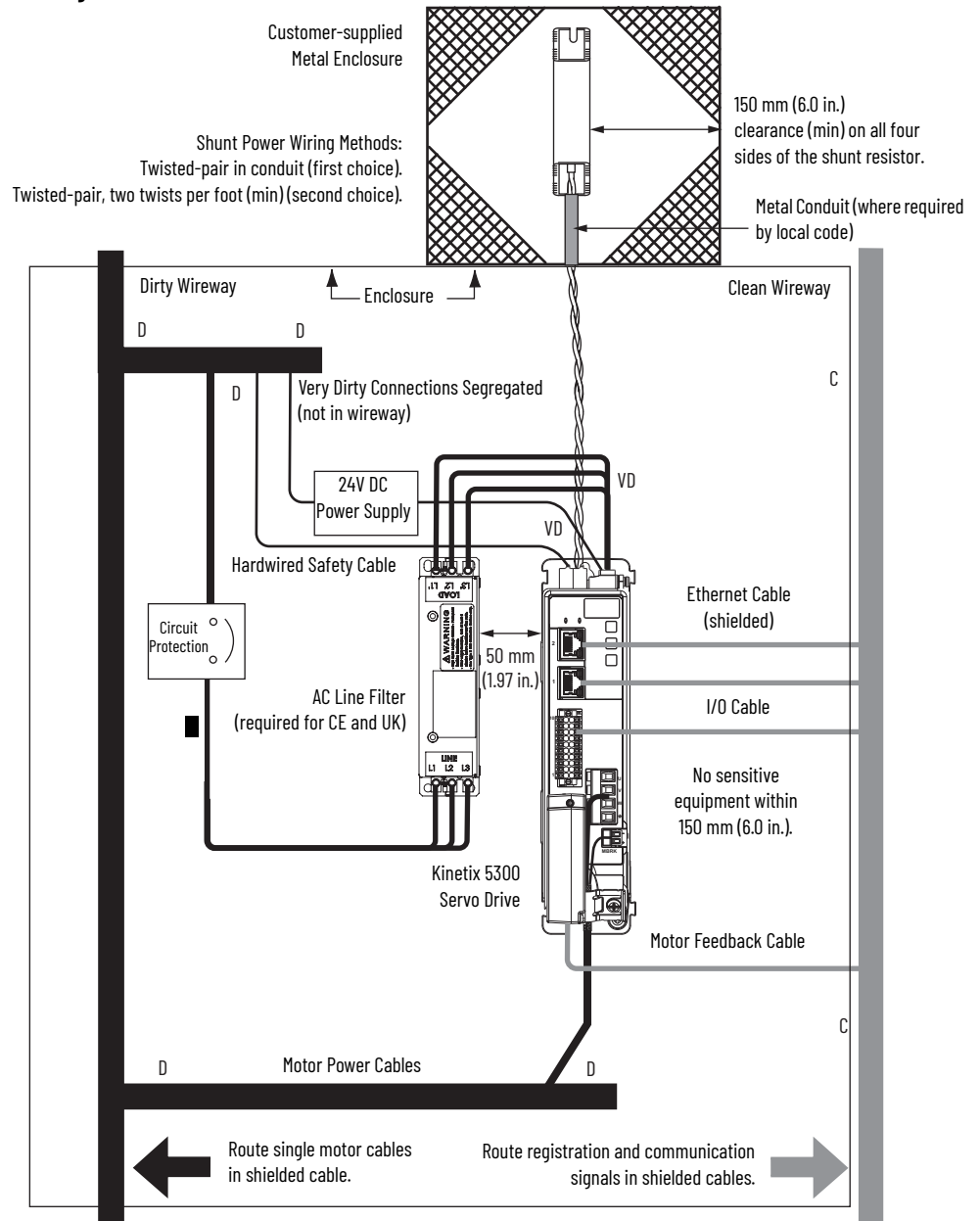

When mounting your Bulletin 2097 or Bulletin 2198 passive-shunt resistor inside the enclosure, follow these additional guidelines:

- Mount metal-clad modules anywhere in the dirty zone, but as close to the Kinetix 5300 drive as possible.
- Route shunt power wires with other very dirty wires.
- Keep unshielded wiring as short as possible. Keep the shunt wiring as flat to the cabinet as possible.
- Separate shunt power cables from other sensitive, low voltage signal cables.

Figure 16 - External Shunt Resistor Inside the Enclosure

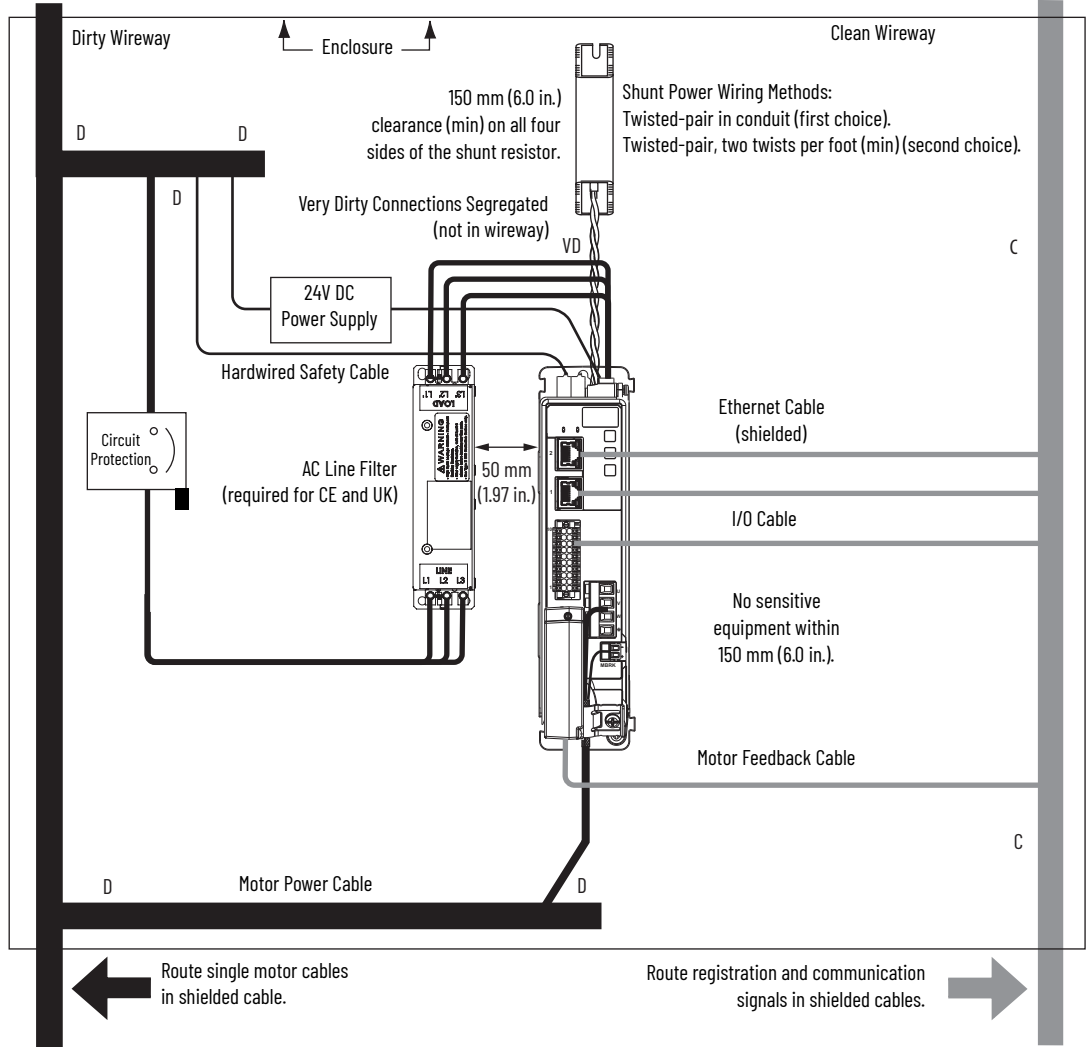



## Mount the Kinetix 5300 Drive System

This chapter provides the system installation procedures for mounting your Kinetix® 5300 drives to the system panel.

Topic	Page
Determine Mounting Order	42
Drill-hole Patterns	44
Mount Your Kinetix 5300 Drive	50

This procedure assumes you have prepared your panel and understand how to bond your system. For installation instructions regarding equipment and accessories that are not included here, refer to the instructions that came with those products.



**SHOCK HAZARD:** To avoid the hazard of electrical shock, perform all mounting and wiring of the Kinetix 5300 drives before applying power. Once power is applied, connector terminals can have voltage present even when not in use.



**ATTENTION:** Plan the installation of your system so that you can perform all cutting, drilling, tapping, and welding with the system removed from the enclosure. Because the system is of the open type construction, be careful to keep metal debris from falling into it. Metal debris or other foreign matter can become lodged in the circuitry and result in damage to the components.

## Determine Mounting Order

When drives are mounted by using the zero-stack feature, they must be mounted from left to right in descending frame-size order. For the drives to engage properly (when multiple frame sizes exist in the drive system) frame 3 drives must mount left of frame 1 or 2 drives, and frame 2 drives must mount left of frame 1 drives.

### Zero-stack Tab and Cutout

Engaging the zero-stack tab and cutout from drive-to-drive makes efficient use of panel space for installations with multiple drives.

---

**IMPORTANT** Engaging the zero-stack tab and cutout from drive-to-drive is required for 24V DC shared-bus drive configurations. This requirement is needed to make sure that the drive connectors are spaced properly to accept the busbars and T-connectors.

---

Figure 17 - Zero-stack Tab and Cutout Example

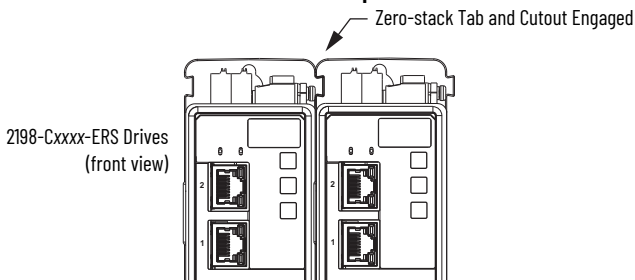



---

**IMPORTANT** Mount drives in descending order, left to right, according to frame size.

---

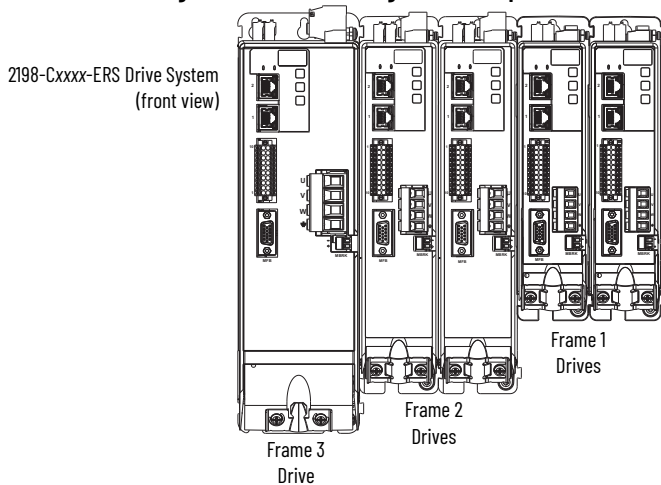
Figure 18 - Drive Mounting Order Example



## Shared-bus Connection System

The shared-bus connection system is used to extend 24V control input from drive-to-drive in shared-bus configurations.

---

**IMPORTANT** When the shared-bus connection system is used, the zero-stack tab and cutout must be engaged between adjacent drives.

---

The connection system is composed of three components:

- Input wiring connectors that plug into the leftmost drive and receive input wiring for 24V DC.
- 24V DC T-connectors that plug into the drives downstream from the first drive where 24V control power is shared.
- Busbars that connect between drives to extend the 24V DC control power from drive-to-drive.

**Figure 19 - Connection System Example**

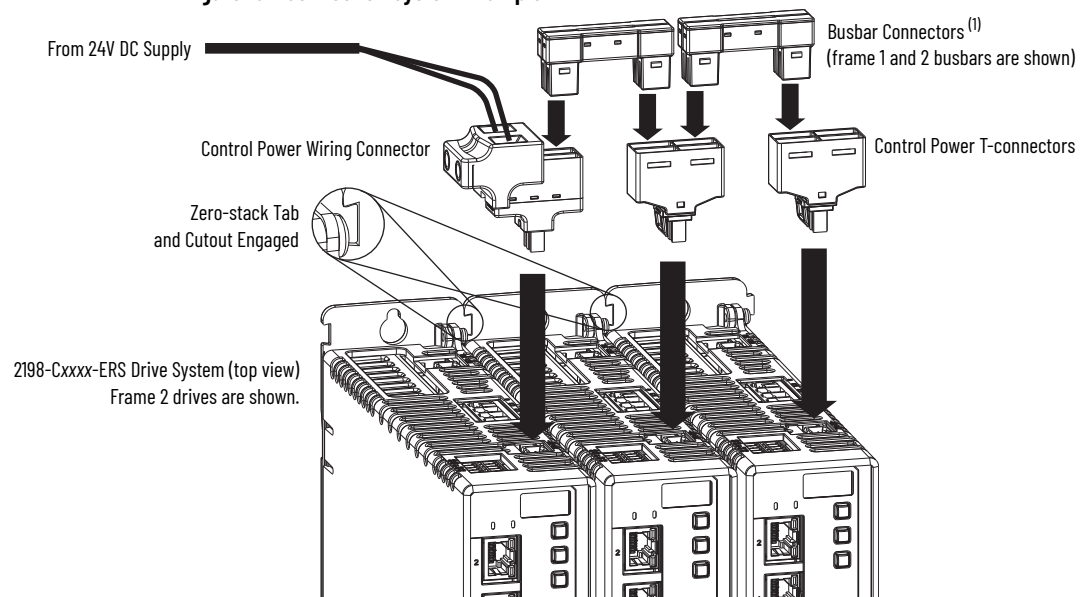

(1) Due to the extra width of frame 3 drives, busbar connectors between frame 3 drives are slightly longer than connectors between frame 3, frame 2, and frame 1 drives.

The three components assemble from left to right across the drive system.

1. Attach wiring to input wiring connectors.
2. Insert input wiring connectors and T-connectors into the appropriate drive connectors.
3. Insert busbars to connect between wiring connectors and T-connectors.

## Drill-hole Patterns

Hole patterns for drives that are mounted in zero-stack or shared-bus configuration are provided for mounting your drives to the panel.

- Frame 1 drives can be followed by only another frame 1 drive.
- Frame 2 drives can be followed by frame 1 drives or another frame 2 drive.
- Frame 3 drives can be followed by frame 1, frame 2, or another frame 3 drive.

These hole patterns apply to standalone drives.

**Figure 20 - Frame 1, Frame 2, and Frame 3 Standalone Hole Patterns**

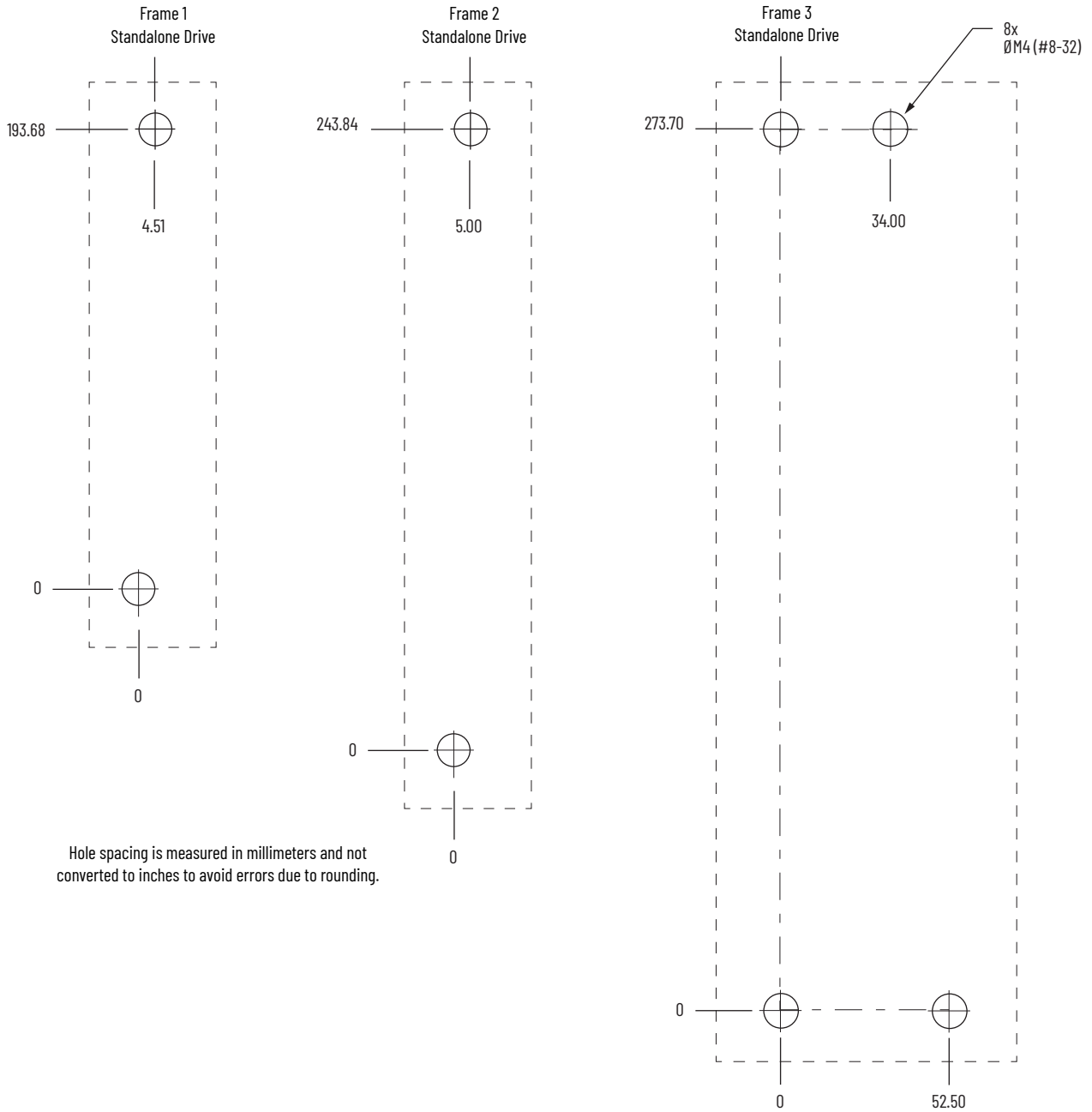

These hole patterns apply when all drives in the system are frame 1 or frame 2. There are 50 mm between mounting holes (A-to-A and B-to-B).

Figure 21 - Frame 1 and Frame 2 Hole Patterns

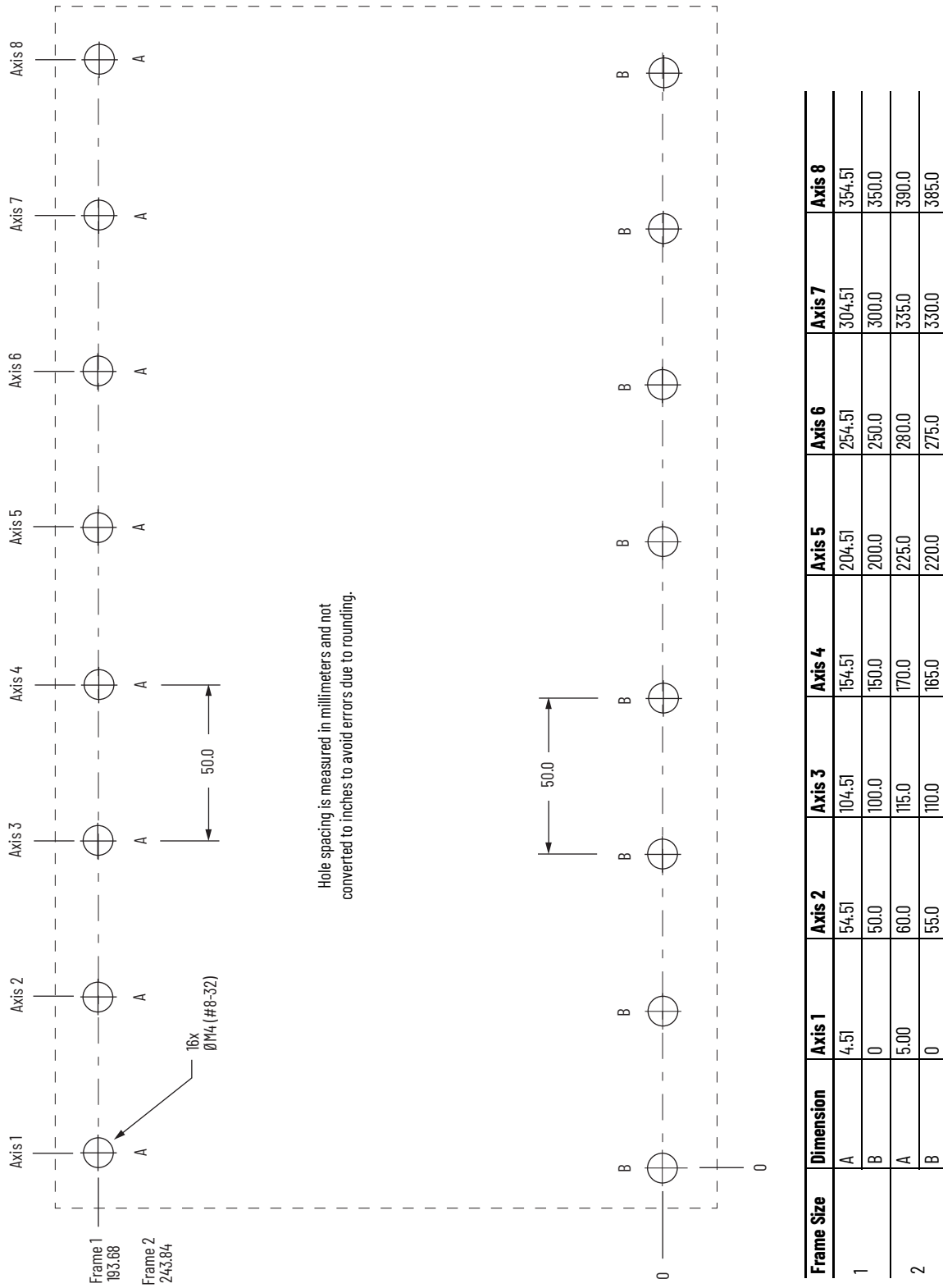

This hole pattern applies when transitioning from frame 2 drives to frame 1 drives. To mount additional frame 1 drives to the right of Axis 2 in this figure, refer to the frame 1 hole pattern in [Figure 22](#).

**Figure 22 - Frame 2 to Frame 1 Hole Pattern**

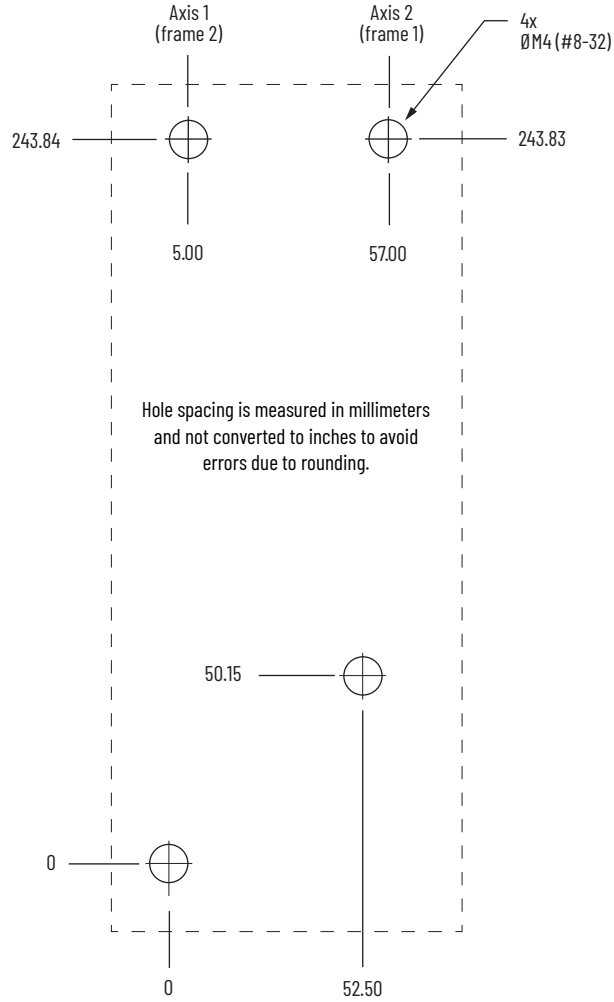

This hole pattern applies when all drives in the system are frame 3 drives. There are 85.20 mm between mounting holes, as shown.

Figure 23 - Frame 3 Hole Pattern

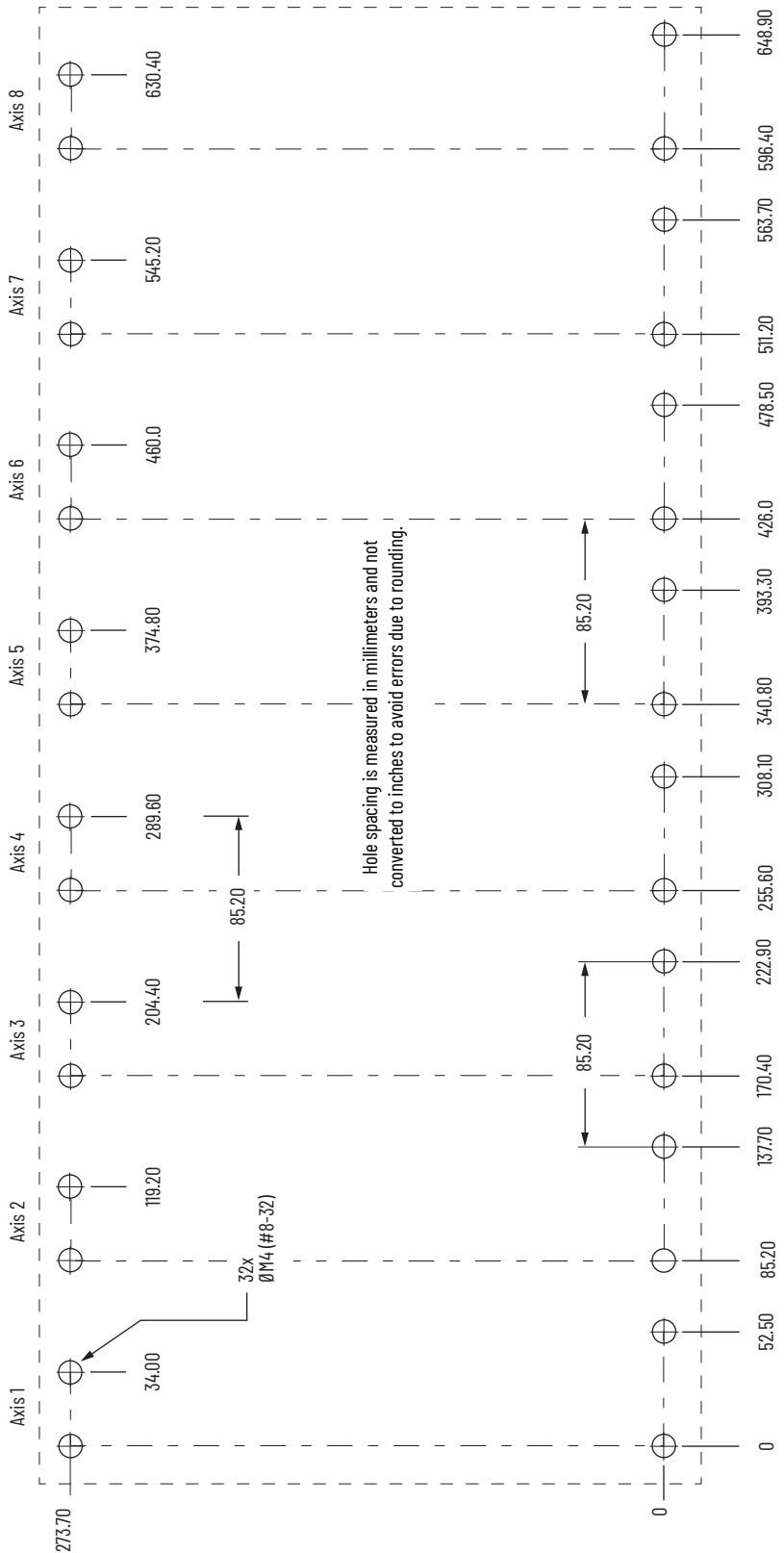

This hole pattern applies when transitioning from frame 3 drives to frame 1 drives. To mount additional frame 1 drives to the right of Axis 2 in this figure, refer to the frame 1 hole pattern in [Figure 21](#).

**Figure 24 - Frame 3 to Frame 1 Hole Pattern**

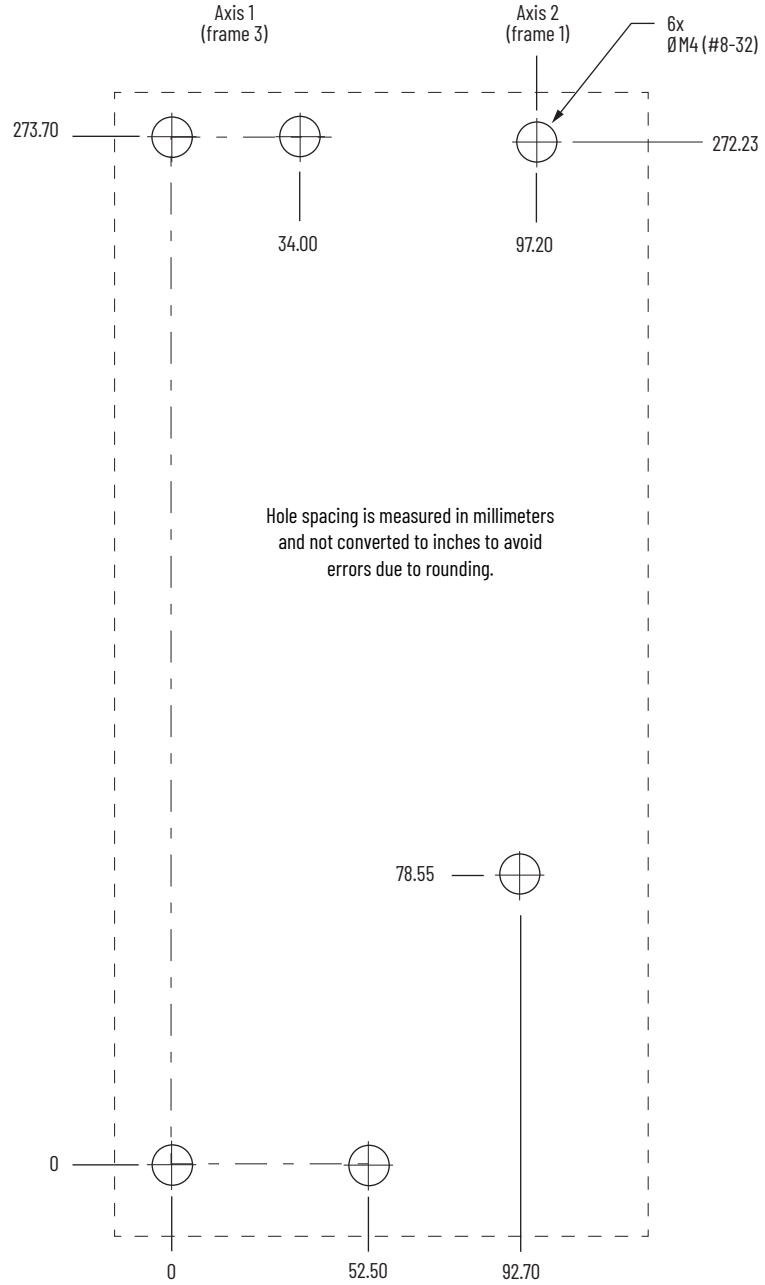



This hole pattern applies when transitioning from frame 3 drives to frame 2 drives. To mount additional frame 2 drives to the right of Axis 2 in this figure, refer to the frame 2 hole pattern in [Figure 21](#).

**Figure 25 - Frame 3 to Frame 2 Hole Pattern**

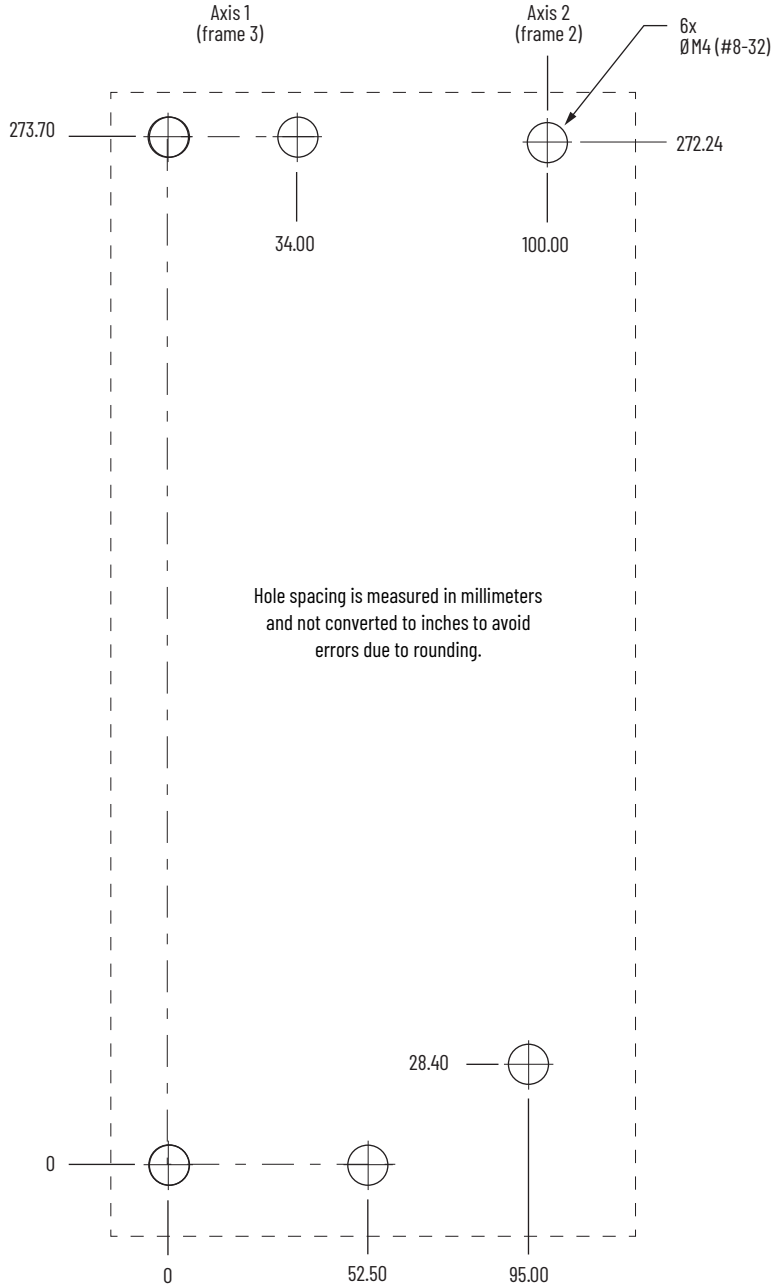

## Mount Your Kinetix 5300 Drive

This procedure assumes you have prepared your panel and understand how to bond your system. For installation instructions regarding other equipment and accessories, refer to the instructions that came with those products.

Follow these steps to mount your Kinetix 5300 drives to the panel.

1. Lay out the hole pattern for each Kinetix 5300 drive in the enclosure.  
For panel layout recommendations, refer to [Establish Noise Zones on page 37](#).

---

**IMPORTANT** To improve the bond between the Kinetix 5300 drive and subpanel, construct your subpanel out of zinc-plated (paint-free) steel.

---

2. Drill holes in the panel for mounting your drive system.  
Hole patterns, by frame size, are shown in [Drill-hole Patterns](#) beginning on [page 44](#).
3. Loosely attach the mounting hardware to the panel.  
The recommended mounting hardware is M4 (#8-32) steel bolts. Observe bonding techniques as described in [HF Bond for Modules on page 34](#).
4. Attach the leftmost drive to the cabinet panel.

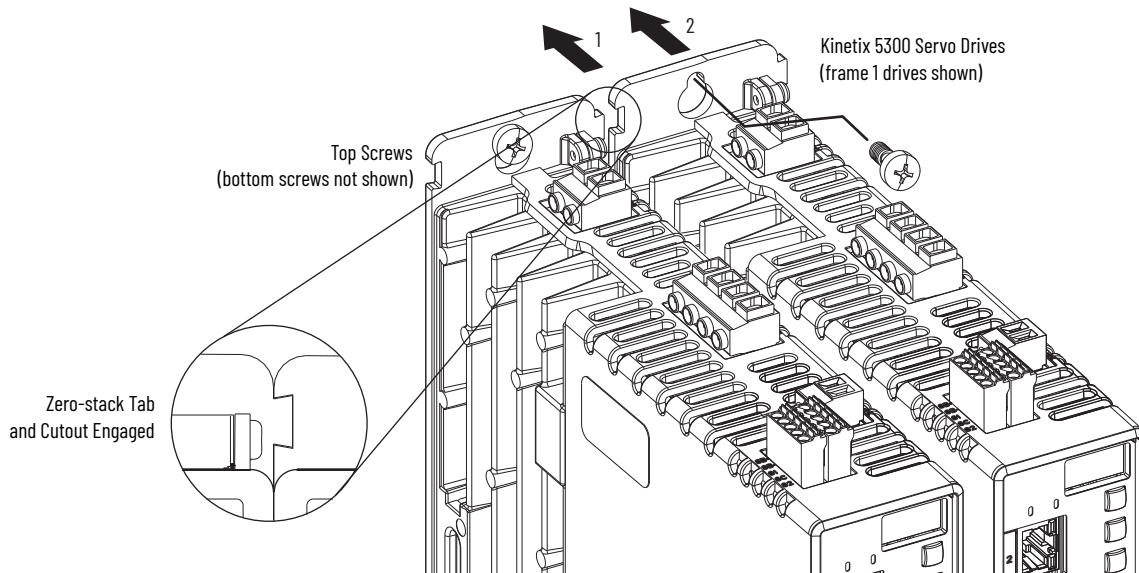

5. Attach additional drives (if any) just to the right of the previous drive by using the same method, but also making sure that the zero-stack tabs and cutouts are engaged.  
Zero-stack mounting is required based on configuration, refer to the [Zero-stack Tab and Cutout Example](#) on [page 42](#).
6. Tighten all mounting fasteners.  
Apply 2.0 N•m (17.7 lb•in) maximum torque to each fastener.

---

## Connector Data and Feature Descriptions

This chapter illustrates drive connectors and indicators, including connector pinouts, and provides descriptions for Kinetix® 5300 drive features.

<b>Topic</b>	<b>Page</b>
Kinetix 5300 Connector Data	52
Understand Control Signal Specifications	56
Feedback Specifications	58
Safe Torque Off Safety Features	65

# Kinetix 5300 Connector Data

Use these illustrations to identify the connectors and indicators for the Kinetix 5300 drive modules.

Figure 26 - Kinetix 5300 Drive Features and Indicators

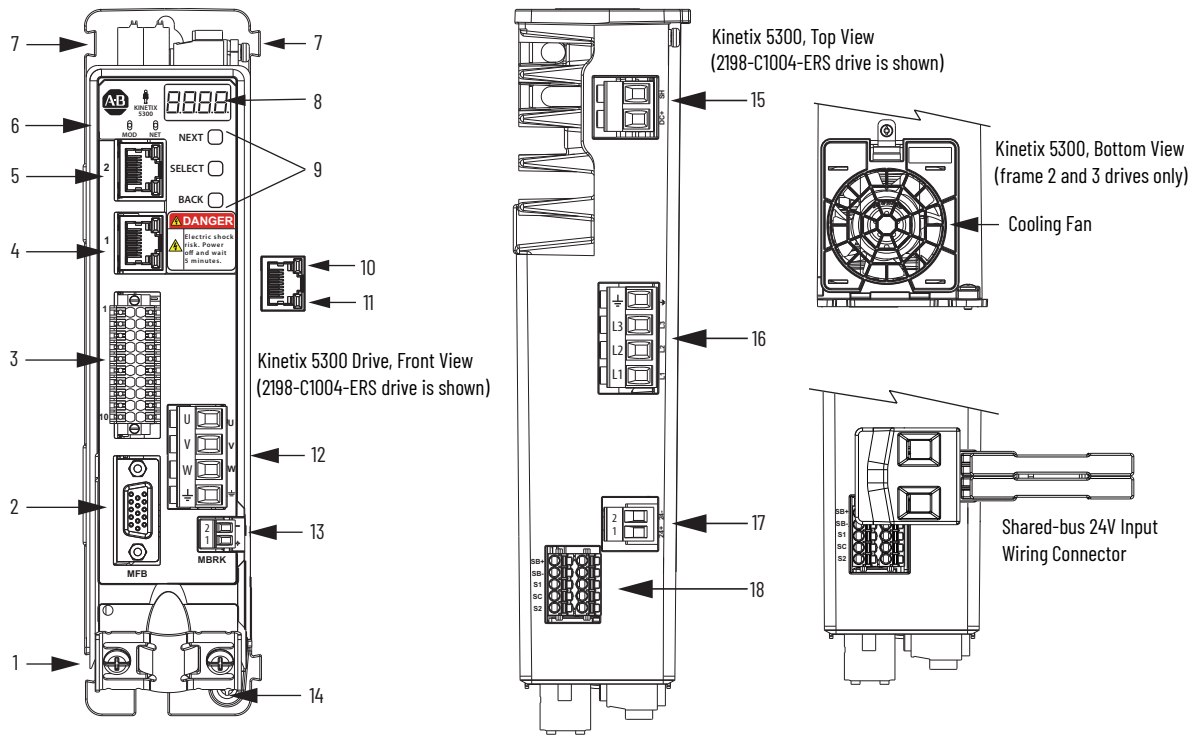

Item	Description
1	Motor cable shield clamp
2	Motor feedback (MFB) connector
3	Digital inputs and auxiliary feedback connector
4	Ethernet (PORT1) RJ45 connector
5	Ethernet (PORT2) RJ45 connector
6	Module and Network status indicators

Item	Description
7	Zero-stack mounting tab/cutout
8	Four-character status display
9	Navigation pushbuttons
10	Link speed status indicators
11	Link/Activity status indicators
12	Motor power connector

Item	Description
13	Motor brake connector
14	Ground terminal
15	Shunt resistor connector
16	AC input power connector
17	24V control input power connector
18	Safe Torque Off (STO) connector

## Safe Torque Off Connector Pinout

For the hardwired Safe Torque Off (STO) connector pinouts, feature descriptions, and wiring information, see [Chapter 9](#) beginning on [page 159](#).

## Input Power Connector Pinouts

Table 13 - AC Input Power Connector

Pin	Description	Signal
$\perp$	Chassis ground	$\perp$
L3	Three-phase input power	L3
L2		L2
L1		L1

Table 14 - 24V DC Input Power Connector

Pin	Description	Signal
1	24V power supply, customer supplied	24V+
2	24V common	24V-

## Shunt Resistor Connector Pinouts

Table 15 - Shunt Resistor Connector

Pin	Description	Signal
-	Shunt connections	DC+
-		SH

## Ethernet Communication Connector Pinout

Pin	Description	Signal
1	Transmit+	TD+
2	Transmit-	TD-
3	Receive+	RD+
4	Reserved	-
5	Reserved	-
6	Receive-	RD-
7	Reserved	-
8	Reserved	-

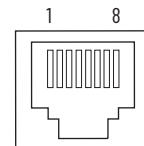

## Digital Inputs and Auxiliary Feedback Connector Pinouts

The Kinetix 5300 drive has four configurable digital inputs and seven configurable functions to choose from in the Logix Designer application.

Table 16 - Digital Inputs and Auxiliary Feedback Connector Pinouts

Pin	Description	Signal	Pin	Description	Signal
1	24V current-sinking fast input #1.	IN1	11	24V current-sinking fast input #3.	IN3
2	I/O common for customer-supplied 24V supply.	COM	12	I/O common for customer-supplied 24V supply.	COM
3	24V current-sinking fast input #2.	IN2	13	24V current-sinking fast input #4.	IN4
4	I/O common for customer-supplied 24V supply.	COM	14	I/O common for customer-supplied 24V supply.	COM
5	I/O cable shield termination point.	SHIELD	15	I/O cable shield termination point.	SHIELD
6	AM Differential Input +	AUX_AM+	16	AM Differential Input -	AUX_AM-
7	BM Differential Input +	AUX_BM+	17	BM Differential Input -	AUX_BM-
8	IM Differential Input +	AUX_IM+	18	IM Differential Input -	AUX_IM-
9	Encoder 5V power output	AUX_EPWR_5V	19	Auxiliary common	AUX_COM
10	Auxiliary feedback cable shield termination point.	SHIELD	20	Auxiliary feedback cable shield termination point.	SHIELD

Although any input can be configured as a registration input, only two can be registration inputs at any one time.

Table 17 - Configurable Functions

Default Configuration <sup>(1)</sup>	Description
	0 = Unassigned
	1 = Enable
	2 = Home
	3 = Registration 1
	4 = Registration 2
	5 = Positive overtravel
	6 = Negative overtravel

(1) Studio 5000 Logix Designer®, version 33 or later, is required to change from the default configuration.

Figure 27 - Pin Orientation for Digital Inputs and Auxiliary Feedback Connector

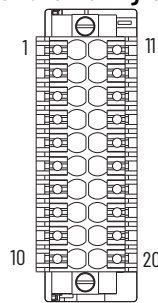

## Motor Power, Brake, and Feedback Connector Pinouts

Table 18 - Motor Power Connector

Pin	Description	Signal
U	Three-phase motor power	U
V		V
W		W
⊥	Chassis ground	⊥



**ATTENTION:** To avoid damage to the Kinetix 5300 drive, make sure that the motor power signals are wired correctly. For motor power connector wiring examples, refer to [Motor Power and Brake Connections on page 80](#).

**IMPORTANT** Drive-to-motor power cables must not exceed 50 m (164 ft), depending on overall system design. System performance was tested at this cable length. These limitations also apply when meeting CE and UK requirements.

**Table 19 - Motor Brake Connector**

Pin	Description	Signal
1	Motor brake connections	MBRK+
2		MBRK-

**Table 20 - Motor Feedback Connector**

MFB Pin	Description	Signal
1	Sine differential input + AM differential input +	MTR_SIN+ MTR_AM+
2	Sine differential input- AM differential input-	MTR_SIN- MTR_AM-
3	Cosine differential input + BM differential input +	MTR_COS+ MTR_BM+
4	Cosine differential input - BM differential input -	MTR_COS- MTR_BM-
5	Data differential input/output + IM differential input +	MTR_DATA+ MTR_IM+
6	Encoder common	MTR_ECOM
7	Encoder 9V power output	MTR_EPWR9V <sup>(2)</sup>
8	Hall commutation S3 input	MTR_S3

MFB Pin	Description	Signal
9	Reserved	-
10	Data differential input/output - IM differential input -	MTR_DATA- MTR_IM-
11	Motor thermostat (normally closed) <sup>(1)</sup>	MTR_TS
12	Hall commutation S1 input	MTR_S1
13	Hall commutation S2 input	MTR_S2
14	Encoder 5V power output	MTR_EPWR5V <sup>(2)</sup>
15	Reserved	-

- (1) Not applicable unless the motor has integrated thermal protection.
- (2) Determine which power supply your encoder requires and connect to only the specified supply. Do not make connections to both supplies.

**Figure 28 - Pin Orientation for 15-pin Motor Feedback (MFB) Connector**

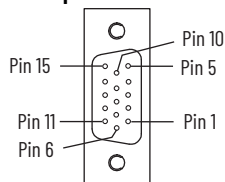

## Understand Control Signal Specifications

This section provides a description of the Kinetix 5300 digital inputs, Ethernet communication, power and relay specifications, encoder feedback specifications, and Safe Torque Off features.

### Digital Inputs

Four digital inputs are available for the machine interface on the digital input connector. Digital inputs require a 24V DC @ 15 mA supply. These digital inputs are sinking inputs that require a sourcing device. A common and cable shield connection is provided on the connector for digital inputs.

**IMPORTANT** To improve registration input EMC performance, refer to the System Design for Control of Electrical Noise Reference Manual, publication [GMC-RM001](#).

**Table 21 - Configurable Digital Input Functions**

Function	Description
Enable	A 24V DC input is applied to this terminal to move the AxisCipDrive from Start-Inhibited to Stopped State.
Home	An active state indicates to a homing sequence that the referencing sensor has been seen. Typically, a transition of this signal is used to establish a reference position for the machine axis.
Registration 1	An inactive-to-active transition (also known as a positive transition) or active-to-inactive transition (also known as a negative transition) is used to latch position values for use in registration moves.
Registration 2	
Positive overtravel Negative overtravel	The positive/negative limit switch (normally closed contact) inputs for each axis require 24V DC (nominal).

**Table 22 - Digital Input Specifications**

Attribute	Value
Input current (typical)	2.5 mA
Input ON voltage range (typical)	15...26.4V DC
Input OFF voltage, max	5V DC
Digital input type according to IEC 61131-2	24V DC Type 1
External power supply	24V DC $\pm$ 10% PELV
Input protection	Optically isolated, reverse voltage protected
Registration accuracy	$\pm$ 3 $\mu$ s
Registration repeatability	1.0 $\mu$ s

### Motor Holding-brake Circuit

The motor brake option is a spring-set holding brake that releases when voltage is applied to the brake coil in the motor. A customer-supplied 24V power supply is used to energize the motor brake output through a solid-state relay. The solid-state brake driver circuit provides the following:

- Brake current-overload protection
- Brake overvoltage protection



Two connections (MBRK+ and MBRK-) are required for the motor brake output. Connections are rated for 2.25 A @ +24V (refer to [Figure 29](#)).

**Figure 29 - Motor Brake Circuit**

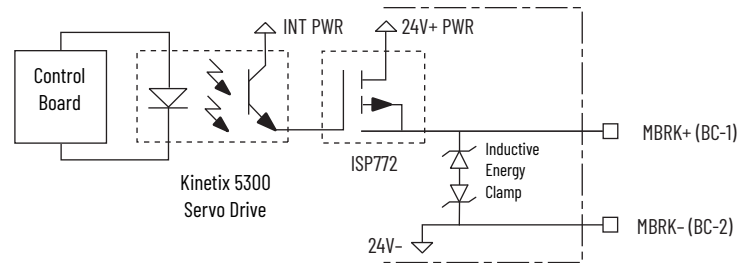

---

**IMPORTANT** Motor holding-brake switching frequency must not exceed 15 cycles/min.

---

Control of the solid-state relay to release the motor brake is configurable in the Logix Designer application (refer to [Configure SPM Motor Closed-loop Control Axis Properties](#) beginning on [page 122](#)). An active signal releases the motor brake. Turn-on and turn-off delays are specified by the MechanicalBrakeEngageDelay and MechanicalBrakeReleaseDelay settings.

---

**IMPORTANT** Holding brakes that are available on Allen-Bradley® rotary motors are designed to hold a motor shaft at 0 rpm for up to the rated brake-holding torque, not to stop the rotation of the motor shaft, or be used as a safety device.

You must command the servo drive to 0 rpm and engage the brake only after verifying that the motor shaft is at 0 rpm.

---

Follow these steps to control a holding brake using a Motion Servo Off (MSF) command.

1. Wire the mechanical brake according to the appropriate interconnect diagram in [Appendix A](#) beginning on [page 169](#).
2. Enter the MechanicalBrakeEngageDelay and MechanicalBrakeReleaseDelay times in the Logix Designer application. See Axis Properties > Parameter List. The delay times must be from the appropriate motor family brake specifications table in the Kinetix Rotary Motion Specifications Technical Data, publication [KNX-TD001](#).
3. Use the drive stop-action default setting (Current Decel & Disable). See Axis Properties > Actions > Stop Action in the Logix Designer application.
4. Use the motion instruction Motion Axis Stop (MAS) to decelerate the servo motor to 0 rpm.
5. To engage the brake and disable drive, use the motion instruction Motion Servo Off (MSF).

For more information on how the servo motor holding-brake option can be used to help keep a load from falling see Vertical Load and Holding Brake Management Application Technique, publication [MOTION-AT003](#).

## Control Power

The Kinetix 5300 drive requires 24V DC input power for control circuitry.

**IMPORTANT** PELV rated power supplies must be used to energize external safety devices that are connected to the Kinetix 5300 safety inputs. The National Electrical Code and local electrical codes take precedence over the values and methods provided. Implementation of these codes is the responsibility of the machine builder.

**Table 23 - Control Power Input Power Specifications**

Attribute	Frame 1	Frame 2	Frame 3
Input voltage	21.6...26.4V DC		
Control power AC input current			
Nom @ 24V DC <sup>(1)</sup>	400 mA	900 mA	1.7 A
Inrush, max	1.8 A	2.4 A	3.0 A

(1) Plus motor brake connector (MBRK+) current.

## Ethernet Communication Specifications

The PORT1 and PORT2 (RJ45) Ethernet connectors are provided for communication with the Logix 5000<sup>®</sup> controller.

Attribute	Value
Communication	The drive auto-negotiates speed and duplex modes. These modes can be forced through the Logix Designer application. 100BASE-TX, full-duplex is recommended for maximum performance.
Cyclic update period	1.0 ms, min
Embedded switch features	Three-port, cut-through, time correction on IEEE-1588 packets, limited filtering, Quality of Service with four priority levels
Auto MDI/MDIX crossover detection/correction	Yes
Port-to-port time synchronization variation	100 ns, max
Cabling	CAT5e shielded, 100 m (328 ft) max

## Feedback Specifications

The Kinetix 5300 drives accept motor feedback of various types on the MFB feedback connector and auxiliary feedback signals from TTL incremental encoders on the digital inputs and auxiliary feedback connector.

**IMPORTANT** Auto configuration in the Logix Designer application of intelligent absolute, high-resolution encoders and incremental encoders is possible with only Allen-Bradley motors.

Motor feedback and auxiliary feedback can be used in the following applications:

- Motor feedback
- Auxiliary feedback and feedback-only axis
- Load feedback (dual-loop control) and master feedback applications

Table 24 - Feedback General Specifications

Attribute	Motor Feedback	Auxiliary Feedback
Feedback device support	<ul style="list-style-type: none"> <li>Nikon (24-bit) serial (Kinetix TLP motors)</li> <li>Hiperface</li> <li>Tamagawa (17-bit) serial (Kinetix TL/TLY motors)</li> <li>Generic TTL Incremental</li> <li>Generic Sine/Cosine Incremental</li> </ul>	Generic TTL Incremental
Power supply voltage (MTR_EPWR5V) Power supply current (MTR_EPWR5V)	5.10...5.40V 300 mA, max	
Power supply voltage (MTR_EPWR9V) Power supply current (MTR_EPWR9V)	8.10...9.90V 150 mA, max	
Thermostat	Single-ended, under 500 Ω = no fault, over 10 kΩ = fault	

## Motor Feedback Supported on the MFB Connector

The Kinetix 5300 drives accept motor feedback signals from Hiperface, Nikon, Tamagawa, generic SIN/COS incremental, and TTL incremental encoders on the feedback (MFB) connector.

Table 25 - Feedback Signals by Device Type

Pin	Hiperface (Kinetix MP)	Nikon (Kinetix TLP)	Tamagawa (Kinetix TL/TLY-B)	Incremental (Kinetix TLY-H)	Generic TTL Incremental	Generic Sine/Cosine
1	MTR_SIN+	-	-	MTR_AM+	MTR_AM+	MTR_SIN+
2	MTR_SIN-	-	-	MTR_AM-	MTR_AM-	MTR_SIN-
3	MTR_COS+	-	-	MTR_BM+	MTR_BM+	MTR_COS+
4	MTR_COS-	-	-	MTR_BM-	MTR_BM-	MTR_COS-
5	MTR_DATA+	MTR_T+	MTR_DATA+ (TLY-B) MTR_SD+ (TL-B)	MTR_IM+	MTR_IM+	MTR_IM+
6	MTR_ECOM	MTR_ECOM	MTR_ECOM	MTR_ECOM	MTR_ECOM	MTR_ECOM
7	MTR_EPWR9V <sup>(1)</sup>	-	-	-	-	-
8	-	-	-	MTR_S3	MTR_S3	MTR_S3
9	-	-	-	-	-	-
10	MTR_DATA-	MTR_T-	MTR_DATA- (TLY-B) MTR_SD- (TL-B)	MTR_IM-	MTR_IM-	MTR_IM-
11	MTR_TS	-	-	-	MTR_TS	MTR_TS
12	-	-	-	MTR_S1	MTR_S1	MTR_S1
13	-	-	-	MTR_S2	MTR_S2	MTR_S2
14	MTR_EPWR5V <sup>(1)</sup>	MTR_EPWR5V	MTR_EPWR5V	MTR_EPWR5V	MTR_EPWR5V	MTR_EPWR5V
15	-	-	-	-	-	-

(1) Determine which power supply your encoder requires and connect to only the specified supply. Do not make connections to both supplies.



**ATTENTION:** To avoid damage to components, determine which power supply your encoder requires and connect to either the 5V or 9V supply, but not both.

Some motors do not support the thermostat signal (MTR\_TS) feature because it is not part of the feedback device.

### Hiperface Feedback

Hiperface absolute high-resolution feedback from Kinetix MP motors and actuators and Kinetix LDAT linear thrusters applies to the 15-pin motor feedback connector.

**Table 26 - Hiperface Specifications**

Attribute	Value
Memory support	Not programmed, or programmed with Allen-Bradley motor data
Hiperface data communication	9600 baud, 8 data bits, no parity
Sine/cosine interpolation	4096 counts/sine period
Input frequency (AM/BM)	250 kHz, max
Input voltage (AM/BM)	0.6...1.2V, peak to peak, measured at the drive inputs
Line loss detection (AM/BM)	Average ( $\sin^2 + \cos^2$ ) > constant
Noise filtering (AM and BM)	Two-stage coarse count pulse reject filter with rejected pulse tally
Incremental position verification	Position comparison between incremental accumulator and serial data performed every 50 ms or less

### Nikon Encoder Feedback Specifications

Nikon (24-bit) absolute high-resolution feedback from Kinetix TLP compact motors applies to the 15-pin motor feedback connector.

**Table 27 - Nikon Encoder Specifications**

Attribute	Value
Encoder nonvolatile memory usage	Programmed with Kinetix TLP motor data as Allen-Bradley memory format
Differential input voltage	1.0...7.0V
Data communication	8 Mbps, 21 data bits, no parity
Battery type	3.6V, ER14252 or equivalent, 1/2 AA size

### Tamagawa Encoder Feedback Specifications

Tamagawa (17-bit) encoder feedback from Kinetix TL-Axxxx-B and TLY-Axxxx-B servo motors applies to the 15-pin motor feedback connector.

**Table 28 - Tamagawa Serial Specifications**

Attribute	Value
Encoder nonvolatile memory usage	Programmed with TL-Axxxx-B and TLY-Axxxx-B motor data as Allen-Bradley memory format.
Differential input voltage	1.0...7.0V
Data communication	2.5 Mbps, 8 data bits, no parity
Battery	3.6V, ER14252 or equivalent, 1/2 AA size

### Generic Sine/Cosine Feedback

Generic sine/cosine incremental feedback applies to the 15-pin motor feedback connector.

**Table 29 - Generic Sine/Cosine Incremental Specifications**

Attribute	Value
Input frequency (MTR_SIN and MTR_COS)	250 kHz, max
Differential input voltage (MTR_SIN and MTR_COS)	0.6...1.2V, peak to peak
Commutation verification	Commutation angle verification that is performed at the first Hall signal transition and periodically verifies thereafter.
Hall inputs (MTR_S1, MTR_S2, and MTR_S3)	Single-ended, TTL, open collector, or none.

See [Encoder Phasing Definitions](#) on [page 63](#) for encoder phasing alignment diagrams.

### Auxiliary Feedback Specifications

The Kinetix 5300 drives support TTL incremental feedback devices on the 20-pin digital inputs and auxiliary feedback connector. To use these devices in your application, refer to [Configure Feedback-only Axis Properties on page 116](#).

**Table 30 - Auxiliary Feedback Signals by Device Type**

Pin	Generic TTL Incremental
6	AUX_AM+
7	AUX_BM+
8	AUX_IM+
9	AUX_EPWR5V
10	SHIELD
16	AUX_AM-
17	AUX_BM-
18	AUX_IM-
19	AUX_COM
20	SHIELD

Specifications for the auxiliary feedback channel are identical to the motor feedback channel, except for specifications related to commutation and encoder nonvolatile memory usage programming.

*Generic TTL Incremental Feedback*

Generic TTL feedback for load feedback, master feedback, and feedback only axes applies to the motor feedback connector (with halls) and auxiliary feedback connector (without halls).

**Table 31 - Generic TTL Incremental Specifications**

Attribute	Value
TTL incremental encoder support	5V, differential A quad B
Quadrature interpolation	4 counts / square wave period
Differential input voltage (MTR_AM, MTR_BM, and MTR_IM)	5V DC, differential line driver (DLD) output compatible
DC current draw (MTR_AM, MTR_BM, and MTR_IM)	30 mA, max
Input signal frequency (MTR_AM, MTR_BM, and MTR_IM)	5.0 MHz, max
Edge separation (MTR_AM and MTR_BM)	42 ns min, between any two edges
Commutation verification	Commutation angle verification that is performed at the first Hall signal transition and periodically verifies thereafter
Hall inputs (MTR_S1, MTR_S2, and MTR_S3)	Single-ended, TTL, open collector, or none

Allen-Bradley Bulletin 844D, 847H, and 847T encoders are the preferred encoders for auxiliary feedback connections.

**Table 32 - Allen-Bradley Auxiliary Feedback Encoders**

Cat. No.	Description
844D-B5CC1FW	HS35, hollow-shaft incremental encoders, rear (through-shaft), 5/8 in., tether, 3/8 in. bolt on a 2.5...4.0 in. diameter, 10-pin connector, 5V DC in, 5V DC DLD out
844D-B5CC1CS	
844D-B5CC1DR	
847H-DN1A-RH01024	Size 25, incremental encoder, standard square flange, 3/8 in. diameter shaft with flat, 4.5...5.5V line driver, TTL (B-Leads-A, CW, Z gated with BN), MS connector, 10-pin
847H-DN1A-RH02048	
847H-DN1A-RH05000	
847T-DN1A-RH01024	Size 20, incremental encoder, standard square flange, 3/8 in. diameter shaft with flat, 4.5...5.5V line driver, TTL (B-Leads-A, CW, Z gated with BN), MS connector, 10-pin
847T-DN1A-RH02048	

See the Kinetix Motion Accessories Technical Data, publication [KNX-TD004](#), for more information on these Allen-Bradley encoders.

## Encoder Phasing Definitions

For TTL encoders, the drive position increases when A leads B. Clockwise motor rotation is assumed, when observing the shaft.

Figure 30 - TTL Encoder Phasing

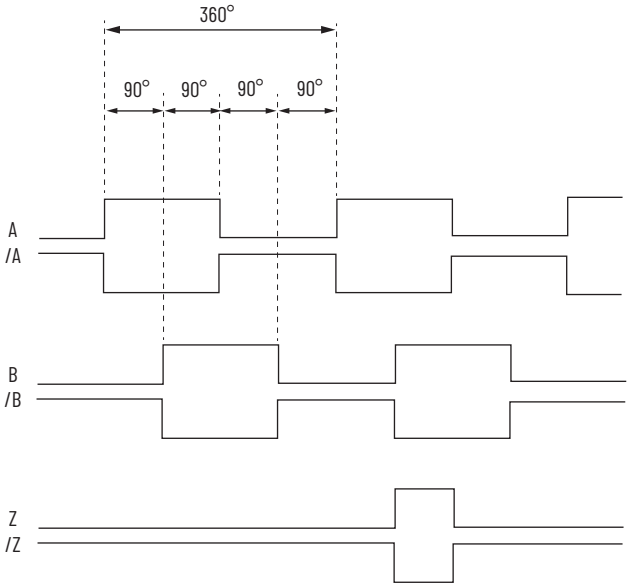

For Sin/Cos encoders, for example Hiperface, the drive position increases when Cosine (B) leads Sine (A). Clockwise motor rotation is assumed, when observing the shaft.

Figure 31 - Sine/Cosine Encoder Phasing

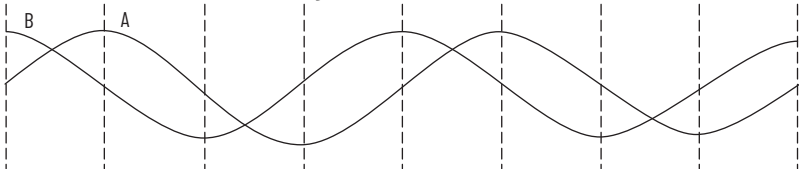

---

**IMPORTANT** The Sine/Cosine encoder signal phasing is different than the TTL encoder signal phasing.

---

**IMPORTANT** When using an incremental Sine/Cosine feedback device, the drive cannot synthesize a marker signal, so a physical marker signal is required for the home-to-marker sequence (and the marker hookup test) to complete.

When using absolute feedback devices (for example, Hiperface), the drive synthesizes a marker signal because these devices don't have a marker signal that is required for the home-to-marker sequence (and the marker hookup test) to complete.

---

The drive MFB feedback connector uses Hall signals to initialize the commutation angle for permanent magnet motor commutation.

Figure 32 - Hall Encoder Phasing

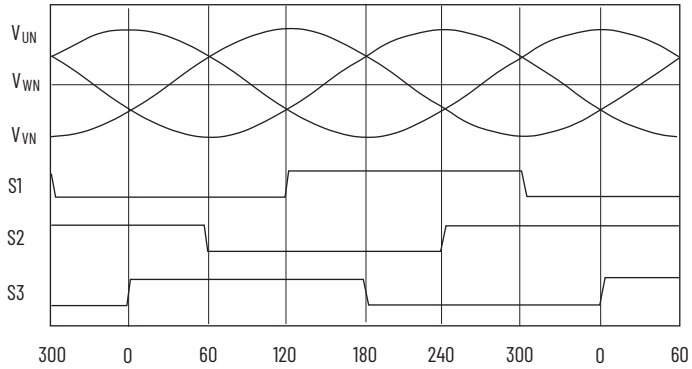

### Absolute Position Feature

The absolute position feature of the drive tracks the position of the motor, within the multi-turn retention limits, while the drive is powered off. The absolute position feature is available with only multi-turn encoders.

Table 33 - Absolute Position Retention Limits

Encoder Type	Cat. No. Designator	Motor Cat. No.	Actuator Cat. No.	Retention Limits	
				Turns (rotary)	mm (linear)
Hiperface	-M	MPL-A/Bxxxx-M MPM-A/Bxxxx-M MPF-A/Bxxxx-M MPS-A/Bxxxx-M	MPAR-A/B3xxx-M MPAI-A/BxxxxM	2048 (±1024)	-
	-V	MPL-A/Bxxxx-V	MPAS-A/Bxxxx1-V05, MPAS-A/Bxxxx2-V20 MPAR-A/B1xxx-V, MPAR-A/B2xxx-V MPAI-A/BxxxxV	4096 (±2048)	-
Nikon (24-bit) serial with battery backup	-D	TLP-A/Bxxx-D	-	65,536 (±32,768)	-
Tamagawa (17-bit) serial with battery backup	-B	TL-Axxx-B TLY-Axxx-B	-		
Hiperface (magnetic scale)	-xDx	-	LDAT-Sxxxxx-xDx	-	960 (37.8)

Figure 33 - Absolute Position Limits (measured in turns or revolutions)

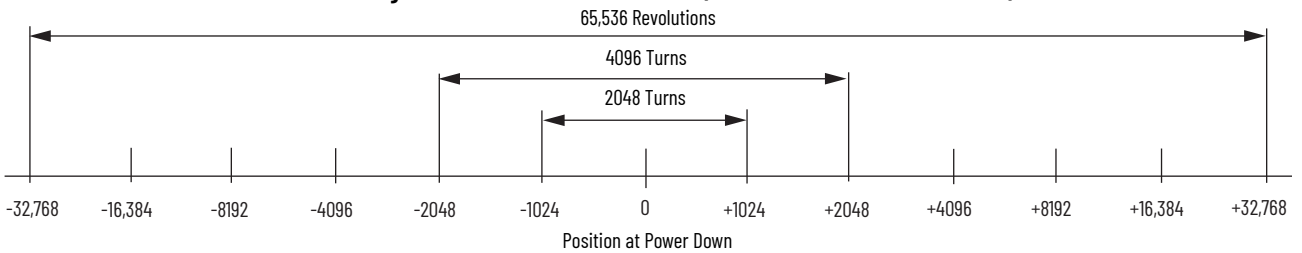



## Safe Torque Off Safety Features

Kinetix 5300 servo drives have Safe Torque Off (STO) capability and can safely turn off the inverter power transistors in response to a monitored digital input, according to Stop Category 0 behavior.

### Servo Drives with Hardwired Safety

2198-Cxxxx-ERS (hardwired) servo drives support parallel input terminals for cascading to adjacent drives over duplex wiring. For applications that do not require the STO safety function, you must install jumper wires to bypass the STO feature.

See [Chapter 9](#) beginning on [page 159](#) for the STO connector pinout, installation, and wiring information.

**Notes:**

## Connect the Kinetix 5300 Drive System

This chapter provides procedures for wiring your Kinetix® 5300 system components and making cable connections.

Topic	Page
Basic Wiring Requirements	67
Determine the Input Power Configuration	69
Ground the Drive System	71
Wiring Requirements	73
Wiring Guidelines	75
Wire the Power Connectors	76
Wire the Digital Input Connectors	77
Wire the Motor Power and Brake Connectors	79
Wire the Motor Feedback Connector	89
External Passive-shunt Resistor Connections	96
Ethernet Cable Connections	97

### Basic Wiring Requirements

This section contains basic wiring information for the Kinetix 5300 drives.



**ATTENTION:** Plan the installation of your system so that you can perform all cutting, drilling, tapping, and welding with the system removed from the enclosure. Because the system is of the open type construction, be careful to keep metal debris from falling into it. Metal debris or other foreign matter can become lodged in the circuitry and result in damage to components.



**SHOCK HAZARD:** To avoid the hazard of electrical shock, perform all mounting and wiring of the Bulletin 2198 drive modules before applying power. Once power is applied, connector terminals can have voltage present even when not in use.

**IMPORTANT**

This section contains common PWM servo system wiring configurations, size, and practices that can be used in most applications. National Electrical Code, local electrical codes, special operating temperatures, duty cycles, or system configurations take precedence over the values and methods provided.

## Build Your Own Cables

---

**IMPORTANT** Factory-made cables are designed to minimize EMI and are recommended over hand-built cables to optimize system performance.

---

Follow these guidelines when building your own cables:

- Connect the cable shield to the connector shells on both ends of the cable with a complete 360° connection.
- Use twisted-pair cable whenever possible. Twist differential signals with each other and twist single-ended signals with the appropriate ground return.

When using Kinetix TLP compact motors, see Build Your Own Kinetix TLP Motor Cables Installation Instructions, publication [2090-IN048](#), to attach motor-side power and feedback connector kits to bulk cable.

When using other Allen-Bradley® servo motors and actuators compatible with 2090-CxxM7DF motor cables, see Kinetix 2090 Circular-DIN Connector Kits, Flange Kits, and Crimp Tools Installation Instructions, publication [2090-IN042](#), to attach motor-side power and feedback connector kits to bulk cable.

Also, see Kinetix 5300 Feedback Connector Kit Installation Instructions, publication [2198-IN023](#), to terminate the flying-lead feedback cable connections.

## Routing the Power and Signal Cables

When you route power and signal wiring on a machine or system, radiated noise from nearby relays, transformers, and other electronic devices can be induced into I/O communication, or other sensitive low voltage signals. This can cause system faults and communication anomalies.

For examples of routing high and low voltage cables in wireways, refer to [Electrical Noise Reduction on page 34](#). Refer to the System Design for Control of Electrical Noise Reference Manual, publication [GMC-RM001](#), for more information.

## Determine the Input Power Configuration

Before wiring input power to your Kinetix 5300 system, you must determine the type of input power within your facility. The drive is designed to operate with only grounded-wye input power. The grounded-wye power configuration lets you ground your single-phase or three-phase power at a neutral point.

This section contains examples of typical single-phase and three-phase facility input power that is wired to single-phase and three-phase Kinetix 5300 drives. Match your secondary to one of the examples and be certain to include the grounded neutral connection.

For Kinetix 5300 drive power specifications, see Kinetix 5700, 5500, 5300, and 5100 Servo Drives Specifications Technical Data, publication [KNX-TD003](#). For Kinetix 5300 drive interconnect diagrams, see [Power Wiring Examples on page 170](#).

### Three-phase Input Power

This example illustrates grounded three-phase power that is wired to three-phase Kinetix 5300 drives when phase-to-phase voltage is within drive specifications.

**Figure 34 - Three-phase (230V or 480V) Grounded Power Configuration (wye secondary)**

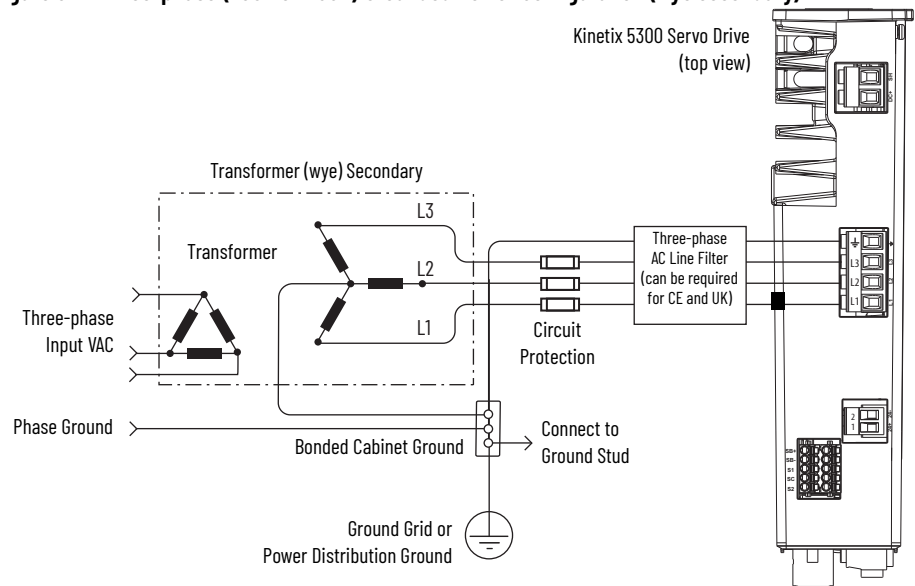

**IMPORTANT** Kinetix 5300 drives must use center-grounded wye secondary input power configurations.

## Single-phase Input Power

These examples illustrate grounded single-phase power that is wired to single-phase Kinetix 5300 drives when phase-to-phase voltage is within drive specifications. You can use any two phases for single-phase input.

Figure 35 - Single-phase (120V or 230V) Grounded Power Configuration

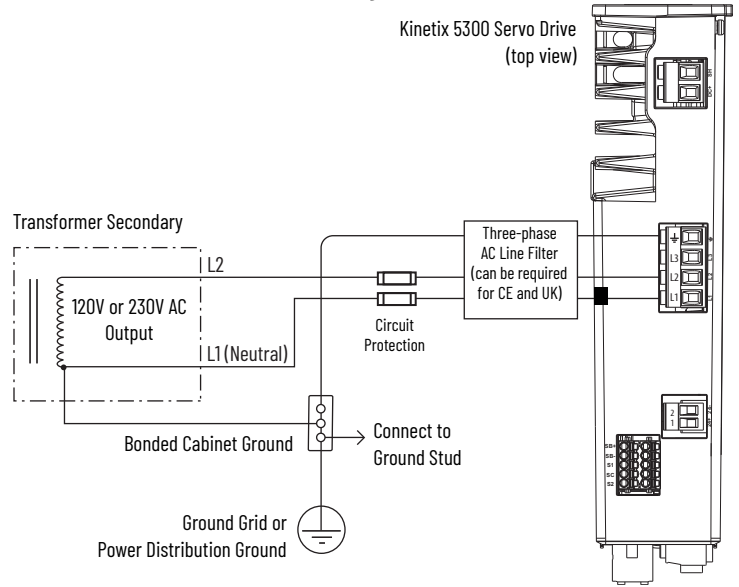

**ATTENTION:** Ungrounded systems do not reference each phase potential to a power distribution ground. This can result in an unknown potential to earth ground.

For input power interconnect diagrams, see [Power Wiring Examples on page 170](#).

## Ground the Drive System

All equipment and components of a machine or process system must have a common earth ground point that is connected to the chassis. A grounded system provides a ground path for protection against electrical shock. Grounding your drives and panels minimize the shock hazard to personnel and damage to equipment caused by short circuits, transient overvoltages, and accidental connection of energized conductors to the equipment chassis.



**ATTENTION:** The National Electrical Code contains grounding requirements, conventions, and definitions. Follow all applicable local codes and regulations to safely ground your system. For CE and UK grounding requirements, refer to [Agency Compliance on page 24](#).

### Ground the System Subpanel

Ground Kinetix 5300 drives to a bonded cabinet ground-bus with a braided ground strap of at least 10 mm<sup>2</sup> (0.0155 in<sup>2</sup>) in cross-sectional area. Keep the braided ground strap as short as possible for optimum bonding.

Figure 36 - Connect the Ground Terminal

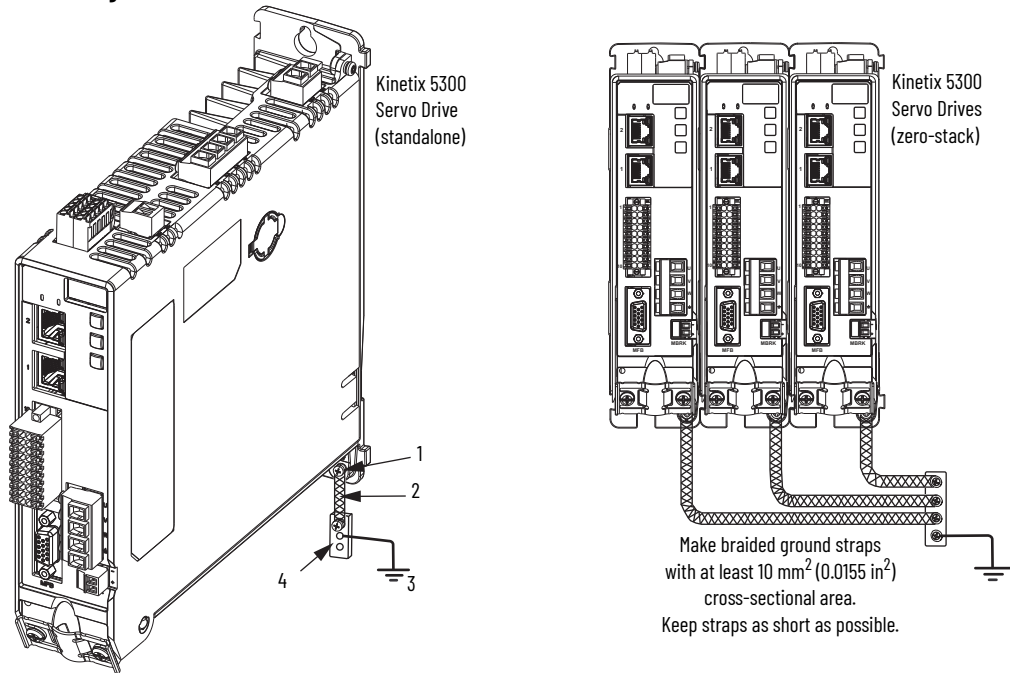

Item	Description
1	Ground screw (green) 2.0 N•m (17.7 lb•in), max
2	Braided ground strap (customer supplied)
3	Ground grid or power distribution ground
4	Bonded cabinet ground bus (customer supplied)

See the System Design for Control of Electrical Noise Reference Manual, publication [GMC-RM001](#), for more information.

## Ground Multiple Subpanels

In this figure, the chassis ground is extended to multiple subpanels.

Figure 37 - Subpanels Connected to a Single Ground Point

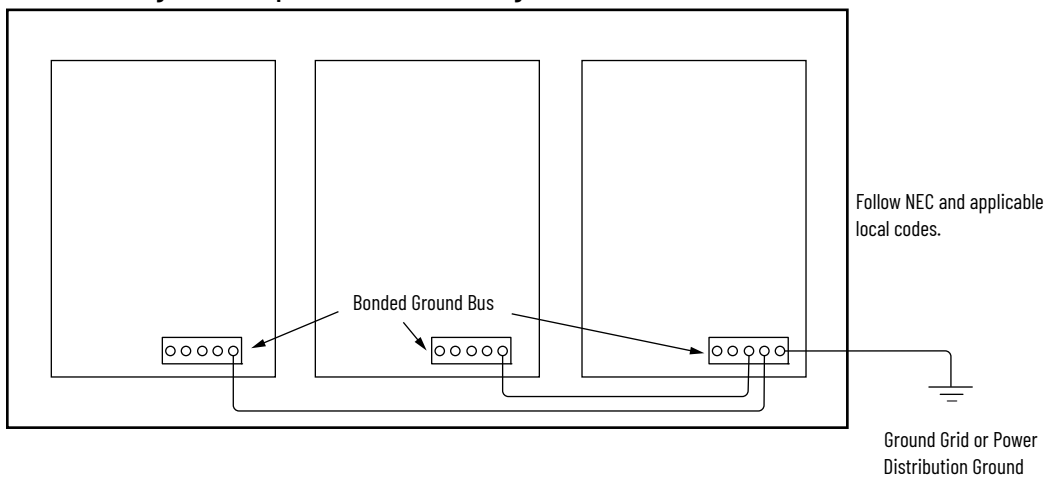

High-frequency (HF) bonding is not illustrated. For HF bonding information, see [HF Bond for Multiple Subpanels on page 36](#).





## Wiring Requirements

Wires must be copper with 75 °C (167 °F) minimum rating. Phasing of main AC power is arbitrary and earth ground connection is required for safe and proper operation.

For interconnect diagrams, refer to [Power Wiring Examples on page 170](#).

**IMPORTANT** The National Electrical Code and local electrical codes take precedence over the values and methods provided.

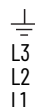
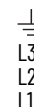
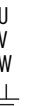
**Table 34 - AC Input Power and Motor Power Wiring Requirements**

Kinetix 5300 Drive Cat. No.	Description	Connects to Terminals		Wire Size mm <sup>2</sup> (AWG)	Strip Length mm (in.)	Torque Value N•m (lb•in)
		Pin	Signal			
2198-C1004-ERS 2198-C1007-ERS 2198-C4004-ERS 2198-C4007-ERS 2198-C1015-ERS 2198-C1020-ERS 2198-C4015-ERS 2198-C4020-ERS 2198-C4030-ERS	AC input power			0.2...2.5 (24...12)	8.0 (0.31)	0.5...0.6 (4.4...5.3)
2198-C2030-ERS				0.2 ... 6.0 (24 ... 10)	10.0 (0.39)	0.5 ... 0.6 (4.4 ... 5.3) <sup>(1)</sup>
2198-C2055-ERS 2198-C2075-ERS 2198-C4055-ERS 2198-C4075-ERS				0.75...16 (18...6)	12.0 (0.47)	1.7 ... 1.8 (15.0...15.9)
2198-C1004-ERS 2198-C1007-ERS 2198-C4004-ERS 2198-C4007-ERS 2198-C1015-ERS 2198-C1020-ERS 2198-C4015-ERS 2198-C4020-ERS 2198-C4030-ERS	Motor power output			Motor power cable depends on motor/drive combination. 0.2...2.5 <sup>(2)</sup> (24...12)	8.0 (0.31)	0.5...0.6 (4.4...5.3)
2198-C2030-ERS				0.2 ... 6.0 <sup>(2)</sup> (24 ... 10)	10.0 (0.39)	0.5 ... 0.6 <sup>(1)</sup> (4.4 ... 5.3)
2198-C2055-ERS 2198-C2075-ERS 2198-C4055-ERS 2198-C4075-ERS				0.75...16 <sup>(2)</sup> (18...6)	12.0 (0.47)	1.7 ... 1.8 (15.0...15.9)

(1) For 10 AWG conductors, use 0.7...0.8 N•m (6.2...7.1 lb•in) of torque.

(2) See Kinetix Rotary and Linear Motion Cable Specifications Technical Data, publication [KNX-TD004](#), for cable specifications and motor/cable pairing.

Table 35 - 24V and Brake Power, Shunt, Safety, and I/O Wiring Requirements

Kinetix 5300 Drive Cat. No.	Description	Connects to Terminals		Wire Size mm <sup>2</sup> (AWG)	Strip Length mm (in.)	Torque Value N•m (lb•in)
		Pin	Signal			
2198-Cxxxx-ERS	PELV 24V power <sup>(1)</sup> (single-axis connector)	1 2	24V+ 24V-	0.2...2.5 (24...12)	7.0 (0.28)	0.5...0.6 (4.4...5.3)
	Brake power	1 2	MBRK+ MBRK-	0.14...1.5 <sup>(2)</sup> (28...16)		0.22...0.25 (1.9...2.2)
	Shunt resistor	— —	DC+ SH	0.2...2.5 (24...12)	8.0 (0.31)	0.5...0.6 (4.4...5.3)
	Safety	STO-1/6 STO-2/7 STO-3/8 STO-4/9 STO-5/10	SB+ SB- S1 SC S2	0.2...1.5 (24...16)	10.0 (0.39)	— <sup>(3)</sup>
	Digital inputs and Auxiliary feedback	1 2 3 4 5 6 7 8 9 10 11 12 13 14 15 16 17 18 19 20	IN1 COM IN2 COM Shield AUX_AM+ AUX_BM+ AUX_IM+ AUX_EPWR_5V Shield IN3 COM IN4 COM Shield AUX_AM- AUX_BM- AUX_IM- AUX_COM Shield	0.2...1.5 (24...16)	10.0 (0.39)	— <sup>(3)</sup>

(1) The wire size, strip length, and torque specifications that are shown here apply to the single-axis connector that ships with the drive. For the shared-bus connector specifications, refer to [Shared-bus 24V Connector Wiring Specifications](#) on page 76.  
 (2) Motor brake wires are part of the Kinetix 2090 motor cable.  
 (3) This connector uses spring tension to hold wires in place.



**ATTENTION:** To avoid personal injury and/or equipment damage, observe the following:

- Make sure that installation complies with specifications regarding wire types, conductor sizes, branch circuit protection, and disconnect devices. The National Electrical Code (NEC) and local codes outline provisions for safely installing electrical equipment.
- Use motor power connectors for connection purposes only. Do not use them to turn the unit on and off.
- Ground shielded power cables to help prevent potentially high voltages on the shield.

## Wiring Guidelines

Use these guidelines as a reference when wiring the power connectors on your Kinetix 5300 drive.

---

**IMPORTANT** For connector locations of the Kinetix 5300 drives, refer to [Kinetix 5300 Connector Data on page 52](#).  
When removing insulation from wires and tightening screws to secure the wires, see the tables in [Wiring Requirements on page 73](#) for strip lengths and torque values.

---

---

**IMPORTANT** To improve system performance, run wires and cables in the wireways as established in [Establish Noise Zones on page 37](#).

---

Follow these steps when wiring the connectors for your Kinetix 5300 drive.

1. Prepare the wires for attachment to each connector plug by removing insulation equal to the recommended strip length.

---

**IMPORTANT** Use caution not to nick, cut, or otherwise damage strands as you remove the insulation.

---

2. Route the cable/wires to your Kinetix 5300 drive.
3. Insert wires into connector plug terminals.  
See the connector pinout tables in [Chapter 2](#) or the interconnect diagrams in [Appendix A](#).
4. Tighten the connector screws (where applicable).
5. Gently pull on each wire to make sure it does not come out of its terminal; reinsert and/or tighten any loose wires.
6. Insert the connector plug into the drive connector.

## Wire the Power Connectors

This section provides examples and guidelines to assist you in making connections to the input power connectors.

For an interconnect diagram, refer to [Power Wiring Examples on page 170](#).

### Wire the 24V Control Power Input Connector

The 24V power connector requires 24V DC input for the control circuitry. The single-axis connector plug is included with the drive, shared-bus connector kits are purchased separately.

Figure 38 - 24V Connector Wiring

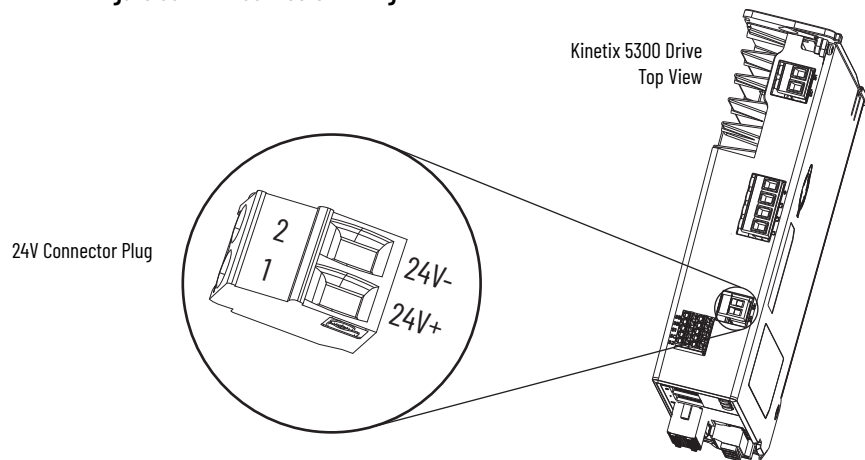

Table 36 - 24V Connector Wiring Specifications

Drive Module Cat. No.	Pin	Signal	Recommended Wire Size mm <sup>2</sup> (AWG)	Strip Length mm (in.)	Torque Value N•m (lb•in)
2198-Cxxxx-ERS	1	24V+	0.2...2.5 (24...12)	7.0 (0.28)	0.22...0.25 (1.9...2.2)
	2	24V-			

Figure 39 - 24V Connector Wiring-Shared Bus

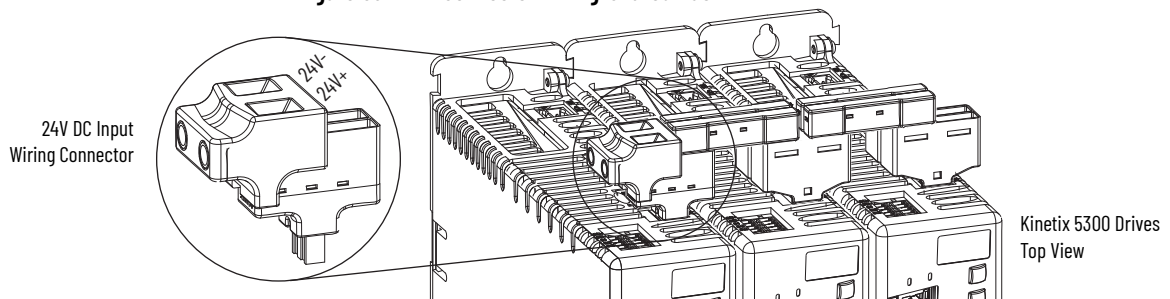

Table 37 - Shared-bus 24V Connector Wiring Specifications

Drive Cat. No.	Pin	Signal	Input Current, Max A rms	Recommended Wire Size mm <sup>2</sup> (AWG)	Strip Length mm (in.)	Torque Value N•m (lb•in)
2198-Cxxxx-ERS	1	24V+	40	10 (6)	11.0 (0.43)	1.7...1.8 (15.0...15.9)
	2	24V-				

## Wire the Input Power Connector

The input power connector requires 110...480V AC, nom (single-phase or three-phase) for AC input power.



**ATTENTION:** Make sure that the input power connections are correct when wiring the connector plug or input wiring connector and that the plug/connector is fully engaged in the drive connector. Incorrect wiring/polarity or loose wiring can cause damage to equipment.

Figure 40 - Input Power Connector Wiring

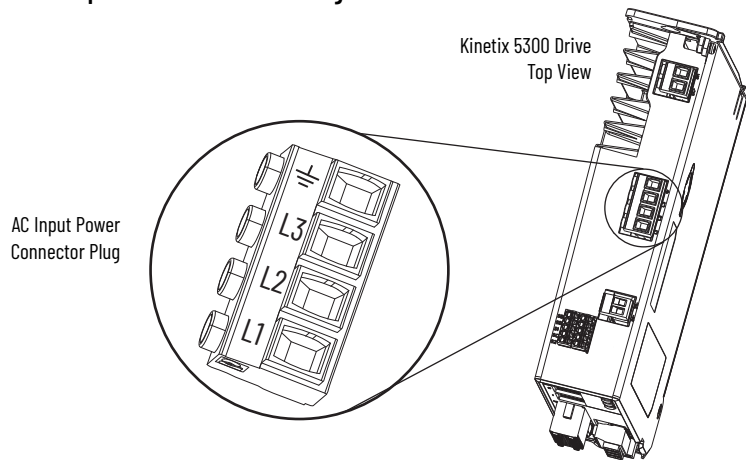

Table 38 - Input Power Connector Wiring Specifications

Kinetix 5300 Drive Cat. No.	Pin	Signal	Recommended Wire Size mm <sup>2</sup> (AWG)	Strip Length mm (in.)	Torque Value N•m (lb•in)
2198-C1004-ERS 2198-C1007-ERS 2198-C4004-ERS 2198-C4007-ERS 2198-C1015-ERS 2198-C1020-ERS 2198-C4015-ERS 2198-C4020-ERS 2198-C4030-ERS	⏏ L3 L2 L1	⏏ L3 L2 L1	0.2...2.5 (24...12)	8.0 (0.31)	0.5...0.6 (4.4...5.3)
2198-C2030-ERS			0.2 ... 6.0 (24 ... 10)	10.0 (0.39)	0.5 ... 0.6 (4.4 ... 5.3) <sup>(1)</sup>
2198-C2055-ERS 2198-C2075-ERS 2198-C4055-ERS 2198-C4075-ERS			0.75...16 (18...6)	12.0 (0.47)	1.7 ... 1.8 (15.0...15.9)

(1) For 10 AWG conductors, use 0.7...0.8 N•m (6.2...7.1 lb•in) of torque.

## Wire the Digital Input Connectors

This section provides guidelines to assist you in making digital input connections.

### Wire the Safe Torque Off Connector

For the hardwired Safe Torque Off (STO) connector pinouts, feature descriptions, and wiring information, see [Chapter 9](#) beginning on [page 159](#).

## Wire the Digital Inputs and Auxiliary Feedback Connector

The digital inputs and auxiliary feedback connector uses spring tension to hold wires in place.

Figure 41 - Digital Inputs and Auxiliary Feedback Connector Wiring

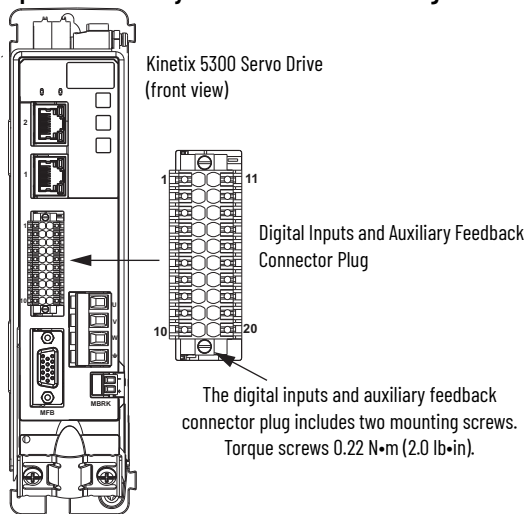

Table 39 - Digital Inputs and Auxiliary Feedback Connector Specifications

Drive Cat. No.	Pin	Signal	Recommended Wire Size mm <sup>2</sup> (AWG)	Strip Length mm (in.)	Torque Value N·m (lb·in)
2198-Cxxx-ERS	1	IN1	0.2...1.5 (24...16)	10.0 (0.39)	_(1)
	2	COM			
	3	IN2			
	4	COM			
	5	SHIELD			
	6	AUX_AM+			
	7	AUX_BM+			
	8	AUX_IM+			
	9	AUX_EPWR_5V			
	10	SHIELD			
	11	IN3			
	12	COM			
	13	IN4			
	14	COM			
	15	SHIELD			
	16	AUX_AM-			
	17	AUX_BM-			
	18	AUX_IM-			
	19	AUX_COM			
	20	SHIELD			

(1) This connector uses spring tension to hold wires in place.

## Wire the Motor Power and Brake Connectors

Motor power and brake connections are made at the motor power and motor brake power connectors on the front of the drive. This section provides examples and guidelines to assist you in making these connections.

Figure 42 - Motor Power Connector Wiring

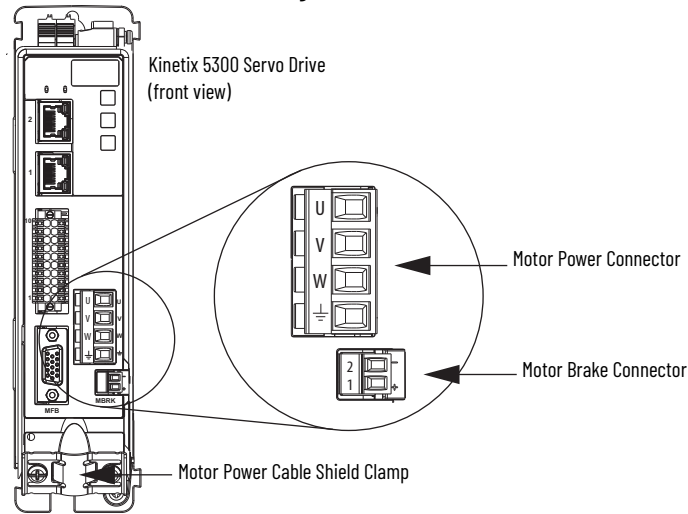

Table 40 - Motor Power Connector Specifications

Kinetix 5300 Drive Cat. No.	Connects to Terminals		Wire Size mm <sup>2</sup> (AWG)	Strip Length mm (in.)	Torque Value N•m (lb•in)
	Pin	Signal			
2198-C1004-ERS 2198-C1007-ERS 2198-C4004-ERS 2198-C4007-ERS 2198-C1015-ERS 2198-C1020-ERS 2198-C4015-ERS 2198-C4020-ERS 2198-C4030-ERS	U V W	U V W	Motor power cable depends on motor/ drive combination. 0.2...2.5 <sup>(1)</sup> (24...12)	8.0 (0.31)	0.5...0.6 (4.4...5.3)
2198-C2030-ERS	⏏	⏏	0.2 ... 6.0 <sup>(2)</sup> (24 ... 10)	10.0 (0.39)	0.5 ... 0.6 <sup>(1)</sup> (4.4 ... 5.3)
2198-C2055-ERS 2198-C2075-ERS 2198-C4055-ERS 2198-C4075-ERS			0.75...16 <sup>(2)</sup> (18...6)	12.0 (0.47)	1.7 ... 1.8 (15.0...15.9)

(1) See Kinetix Rotary and Linear Motion Cable Specifications Technical Data, publication [KNX-TD004](#), for cable specifications.

Table 41 - Brake Power Connector Specifications

Kinetix 5300 Drive Cat. No.	Connects to Terminals		Wire Size mm <sup>2</sup> (AWG)	Strip Length mm (in.)	Torque Value N•m (lb•in)
	Pin	Signal			
2198-Cxxx-ERS	1 2	MBRK+ MBRK-	0.14...1.5 <sup>(1)</sup> (28...16)	7.0 (0.28)	0.22...0.25 (1.9...2.2)

(1) Motor brake wires are part of the Kinetix 2090 motor cable.

## Servo Motor/Actuator and Cable Compatibility

Kinetix 5300 drives are compatible with the following Allen-Bradley rotary and linear products:

- Kinetix TLP compact motors
- Kinetix MP motor family includes:
  - Kinetix MPL, MPM, MPE, and MPS servo motors
- Kinetix TL and TLY servo motors
- Kinetix MP linear actuator family includes:
  - Kinetix MPAS, MPMA, MPAR, and MPAI linear actuators
- Kinetix LDAT linear thrusters
- Kinetix LDC and Kinetix LDL linear motors

**IMPORTANT** To configure these motors and actuators with your Kinetix 5300 servo drive (see [Table 42](#) and [Table 43](#)), you must have drive firmware revision 13 or later and Studio 5000 Logix Designer® application, version 33 or later.

## Motor Power and Brake Connections

Most compatible Allen-Bradley motors and actuators have separate power/brake and feedback cables. Some Kinetix TLP and TL motors have separate brake cables too. The motor power/brake cable shield attaches to the cable clamp on the drive and the conductors attach to the motor power and motor brake connector plugs.

**Table 42 - Kinetix TLP Motor Power/Brake Cable Compatibility**

Servo Motor Cat. No.	Motor Power Cat. No. <sup>(1)</sup> (with brake wires)	Motor Power Cat. No. <sup>(1)</sup> (without brake wires)	Brake Power Cat. No. <sup>(1)</sup>
TLP-A046-xxx, TLP-A70-xxx TLP-A090-xxx, TLP-A100-xxx TLP-A115-xxx, TLP-A145-xxx	2090-CTPB-MxDF-xxAxx (standard) or 2090-CTPB-MxDF-xxFxx (continuous-flex)	2090-CTPW-MxDF-xxAxx (standard) or 2090-CTPW-MxDF-xxFxx (continuous-flex)	— <sup>(2)</sup>
TLP-A200-200, TLP-A200-300 TLP-A200-350, TLP-A200-450			
TLP-A200-550, TLP-A200-750 <sup>(3)</sup>	—	2090-CTPW-MEDF-06Axx (standard) or 2090-CTPW-MEDF-06Fxx (continuous-flex)	2090-CTPB-MBDF-20Axx (standard) or 2090-CTPB-MBDF-20Fxx (continuous-flex)
TLP-B070-040 TLP-B090-075	2090-CTPB-MADF-18Axx (standard) or 2090-CTPB-MADF-18Fxx (continuous-flex)	2090-CTPW-MADF-18Axx (standard) or 2090-CTPW-MADF-18Fxx (continuous-flex)	
TLP-B115-100, TLP-B115-200 TLP-B145-050, TLP-B145-100 TLP-B145-150, TLP-B145-200	2090-CTPB-MCDF-16Axx (standard) or 2090-CTPB-MCDF-16Fxx (continuous-flex)	2090-CTPW-MCDF-16Axx (standard) or 2090-CTPW-MCDF-16Fxx (continuous-flex)	
TLP-B145-250	2090-CTPB-MCDF-12Axx (standard) or 2090-CTPB-MCDF-12Fxx (continuous-flex)	2090-CTPW-MCDF-12Axx (standard) or 2090-CTPW-MCDF-12Fxx (continuous-flex)	— <sup>(2)</sup>
TLP-B200-300, TLP-B200-450	2090-CTPB-MDDF-12Axx (standard) or 2090-CTPB-MDDF-12Fxx (continuous-flex)	2090-CTPW-MDDF-12Axx (standard) or 2090-CTPW-MDDF-12Fxx (continuous-flex)	
TLP-B200-550, TLP-B200-750	2090-CTPB-MDDF-08Axx (standard) or 2090-CTPB-MDDF-08Fxx (continuous-flex)	2090-CTPW-MDDF-08Axx (standard) or 2090-CTPW-MDDF-08Fxx (continuous-flex)	

(1) For cable specifications, refer to the Kinetix Rotary and Linear Motion Cable Specifications Technical Data, publication [KNX-TD004](#).

(2) Brake conductors are included in the power cable.

(3) These motors have separate brake connectors and brake cables. All other motors have brake wires that are included with the power connectors.



Table 43 - Kinetix MP, LDAT, LDC, and LDL Motor Power Cable Compatibility

Motor/Actuator Cat. No.	Motor Power Cat. No. <sup>(1)</sup> (with brake wires)	Motor Power Cat. No. <sup>(1)</sup> (without brake wires)
MPL-A/B15xxx-xx7xAA, MPL-A/B2xxx-xx7xAA, MPL-A/B3xxx-xx7xAA, MPL-A/B4xxx-xx7xAA, MPL-A/B45xxx-xx7xAA, MPL-A/B5xxx-xx7xAA, MPL-B6xxx-xx7xAA	2090-CPBM7DF-xxAAxx (standard) or 2090-CPBM7DF-xxAFxx (continuous-flex)	2090-CPWM7DF-xxAAxx (standard) or 2090-CPWM7DF-xxAFxx (continuous-flex)
MPM-A/Bxxxx, MPF-A/Bxxxx, MPS-A/Bxxxx		
MPAS-A/Bxxxx1-V05SxA, MPAS-A/Bxxxx2-V20SxA MPAI-A/Bxxxx, MPAR-A/B3xxx, MPAR-A/B1xxx and MPAR-A/B2xxx (series B)		
MPAS-Bxxxx-ALMx2C LDAT-Sxxxxx-xDx LDAT-Sxxxxx-xBx LDC-Cxxxxxx LDL-xxxxxxx	_(2)	

(1) For cable specifications, refer to the Kinetix Rotary and Linear Motion Cable Specifications Technical Data, publication [KNX-TD004](#).

(2) These devices do not include a brake option.

Table 44 - Kinetix TL and TLY Motor Power/Brake Cable Compatibility

Motor/Actuator Cat. No.	Motor Power Cat. No. <sup>(1)</sup> (with brake wires)	Motor Power Cat. No. <sup>(1)</sup> (without brake wires)	Brake Cat. No. <sup>(1)</sup>
TLY-Axxxx	2090-CPBM6DF-16AAxx (standard)	2090-CPWM6DF-16AAxx (standard)	— Brake conductors are included in the power cable.
TL-Axxxx	—	2090-DANPT-16Sxx	2090-DANBT-18Sxx

(1) For cable specifications, refer to the Kinetix Rotary and Linear Motion Cable Specifications Technical Data, publication [KNX-TD004](#).

See [Motor Power Connector Wiring](#) on [page 79](#) for motor power and brake connector specifications.

Table 45 - Legacy Motor Power Cables

Motor Cable	Description	Motor Power Cat. No.
Standard	Power/brake, threaded	2090-XXNPMF-xxSxx
	Power-only, bayonet	2090-XXNPMP-xxSxx
Continuous-flex	Power/brake, threaded	2090-CPBM4DF-xxAFxx
	Power-only, threaded	2090-CPWM4DF-xxAFxx
	Power-only, bayonet	2090-XXTPMP-xxSxx

Table 46 - Induction Motor Power Cable Specifications

Cable Manufacturer	Cable Series	Voltage Rating	Temperature Rating	Cable Length, Max
Belden	29505-29507	1000V	90 °C (194 °F)	50 m (164 ft)
Lapp Group	ÖLFEX VFD XL			
SAB	VFD XLPE TR			

## Maximum Cable Lengths

The maximum drive-to-motor power and feedback cable length depends on the AC input power and feedback type.

**Table 47 - Maximum Cable Lengths**

Compatible Motor and Actuator Cat. No.	Feedback Type	Cable Length, Max m (ft)	
		≤ 400V AC Input	480V AC Input
TLP-A/Bxxx-xxx-D	Nikon (24-bit) absolute high-resolution, multi-turn and single-turn	50 (164)	
MPL-A/B15xxx-V/Ex7xAA MPL-A/B2xxx-V/Ex7xAA	Hiperface, absolute high-resolution, multi-turn and single-turn	50 (164)	20 (65.6)
MPL-A/B3xxx-S/Mx7xAA MPL-A/B4xxx-S/Mx7xAA MPL-A/B45xxx-S/Mx7xAA MPL-A/B5xxx-S/Mx7xAA MPL-B6xxx-S/Mx7xAA		50 (164)	
MPM-A/Bxxxx-S/M MPF-A/Bxxxx-S/M MPS-A/Bxxxx-S/M			
MPAR-A/B3xxxx-M			
MPAS-A/Bxxxx1-V05SxA (ballscrew) MPAS-A/Bxxxx2-V20SxA (ballscrew) MPAR-A/B1xxx-V and MPAR-A/B2xxx-V (series B) MPAI-A/BxxxxM3		Absolute high-resolution, multi-turn	50 (164)
MPL-A/B15xxx-Hx7xAA MPL-A/B2xxx-Hx7xAA	Incremental encoder	30 (98.4)	20 (65.6)
MPL-A/B3xxx-Hx7xAA MPL-A/B4xxx-Hx7xAA MPL-A/B45xxx-Hx7xAA			
MPAS-A/Bxxxx-ALMx2C (direct-drive)		Incremental, magnetic linear	30 (98.4)
TLY-Axxx-B	Tamagawa (17-bit) absolute high-resolution, multi-turn		
TL-Axxx-B			
TLY-Axxx-H	Incremental encoder		
LDAT-Sxxxxx-xDx	Hiperface, absolute, magnetic scale		
LDAT-Sxxxxx-xBx	Incremental, magnetic scale	10 (33.1)	
LDC-Cxxxxx-xH, LDL-xxxxxx-xH	Sin/Cos or TTL encoder		

### Cable Preparation for Kinetix TLP Motor Power Cables

For 2090-CTPx-MxDF 10...18 AWG motor cables, you must remove the ring lug and strip the insulation back the appropriate length for the ground conductor.

For 2090-CTPx-MxDF 6...8 AWG motor cables, you must remove the ring lugs and strip the insulation back the appropriate length for U,V,W, and ground conductors.

**Figure 43 - 2090-CTPx-MxDF Power/brake Cable Dimensions**

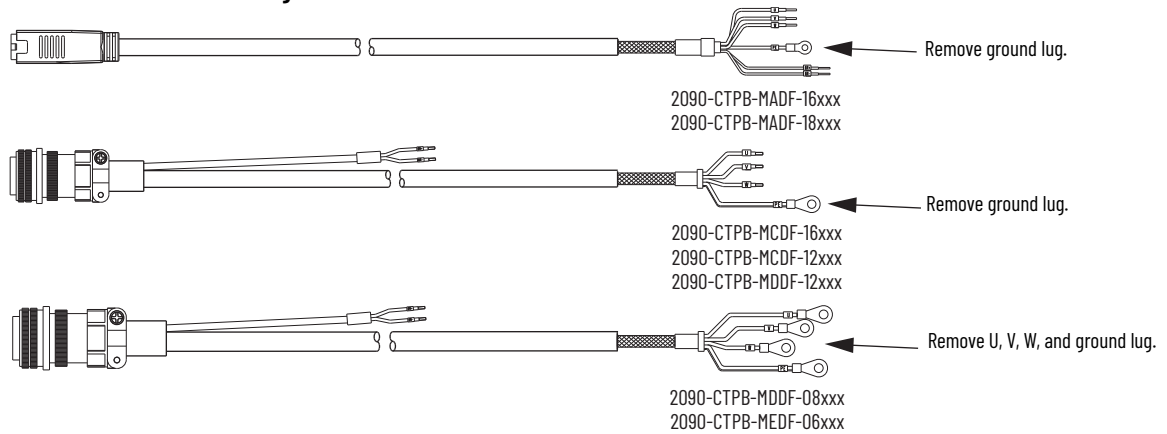

See [Motor Power Connector Wiring](#) on [page 79](#) for the appropriate strip length.

If you are building your own cables, see [Build Your Own Kinetix TLP Motor Cables Installation Instructions](#), publication [2090-IN048](#), to attach motor-side power and feedback connector kits to bulk cable.

### Cable Preparation for 2090-CPxM7DF Motor Power Cables

2090-CPxM7DF cables are available with and without brake conductors. This explanation addresses 2090-CPBM7DF cables with brake conductors. 2090-CPWM7DF cables do not include brake conductors.

#### Motor Power/Brake Cable Series Change

Motor power and brake conductors on 2090-CPBM7DF (series A) cables have the following dimensions from the factory.

**Figure 44 - 2090-CPBM7DF (series A) Power/brake Cable Dimensions**

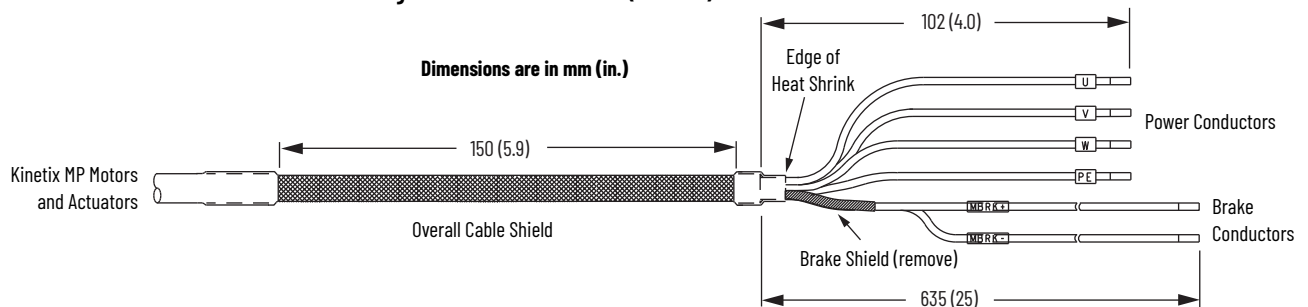

Motor power and brake conductors on 2090-CPBM7DF (12 AWG and 10 AWG) series B standard (non-flex) cables provide drive-end shield braid and conductor preparation that is modified for compatibility with multiple Kinetix servo drive families, including Kinetix 5300 drives.

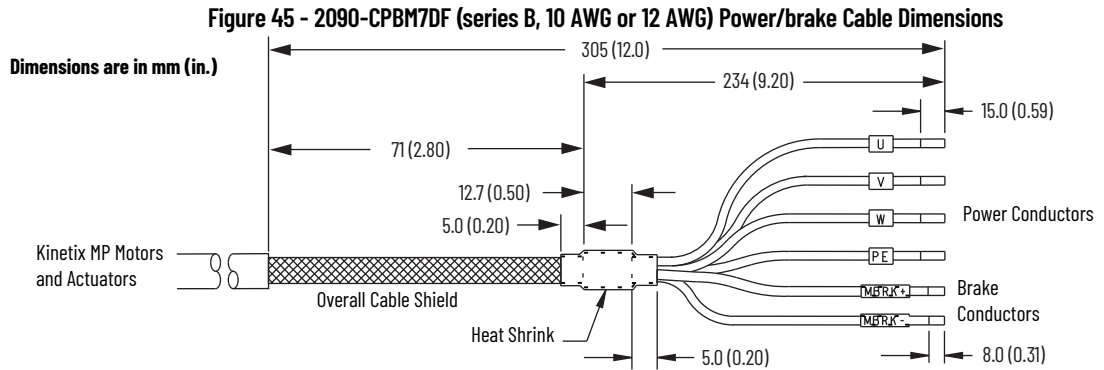

**Cable Preparation for 2090-CPBM7DF (16, 14, 8, and 6 AWG) Series A Cables**

The 2090-CPBM7DF (16 AWG, 14 AWG, 8 AWG, and 6 AWG) power conductor length, 102 mm (4.0 in.), is sufficiently long to reach the motor power connector plug and provide adequate stress relief.

The brake conductor length, 635 mm (25 in.), is much longer than necessary. We recommend that you measure 163 mm (6.4 in.) from the edge of the cable jacket (that is covered by heat shrink) and trim off the rest.

See [Figure 48](#) on [page 88](#) for a typical installation example. For strip lengths and torque values, refer to [Table 40](#) on [page 79](#).

**Cable Preparation for 2090-CPBM7DF (12 AWG and 10 AWG) Series B Cables**

2090-CPBM7DF (12 AWG and 10 AWG) series B cables are designed for use with Kinetix 5300 drives and do not require any modifications.

For frame 2 drives, the 12 AWG cable is compatible with all frame 2 drives, however, the 10 AWG cable is compatible with only the 2198-C2030-ERS drive. Frame 3 drives are compatible with 12 AWG and 10 AWG cable.

**Cable Preparation for 2090-CPBM7DF (12 AWG and 10 AWG) Series A Cables**

These guidelines apply to existing Kinetix drive installations that are upgrading with Kinetix 5300 drives. For 2090-CPBM7DF (12 AWG and 10 AWG) series A cables to terminate properly with Kinetix 5300 drives, the overall length of the cable preparation area must be increased. This increase is required for the motor power conductors to reach the motor power connector and also provide a proper service loop.

Follow these steps to prepare your existing 12 AWG and 10 AWG (series A) cables.

1. Remove a total of 325 mm (12.8 in.) of cable jacket from your existing cable.  
Once this length of cable jacket is removed, additional cable shield is exposed.
2. Remove all but 63.5 mm (2.5 in.) of the shield.
3. Cover 12.5 mm (0.5 in.) of the shield ends and an equal length of the conductors with 25 mm (1 in.) of electrical tape or heat shrink.  
Do the same on the other side of the cable shield. This step keeps the shield ends from fraying and holds the conductors together.
4. Cut the brake conductors back to 163 mm (6.4 in.) and trim the shield braid at the base of the jacket.  
The shield braid that covers the brake conductors is not needed.
5. Remove the specified length of insulation from the end of each wire.

**Figure 46 - Power/brake Cable (12 AWG and 10 AWG)**

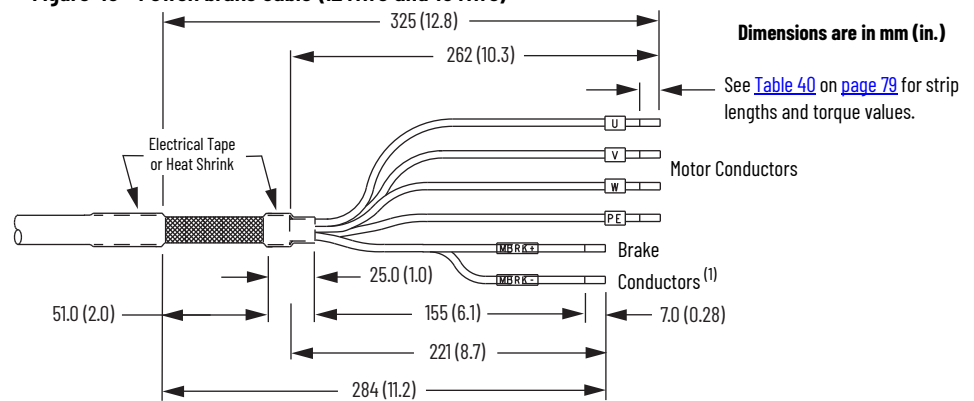

(1) The overall shield braid covering the brake conductors can be removed.

See Figure 48 and on page 88 for a typical installation example. For strip lengths and torque values, refer to Table 40 on page 79.

## Cable Preparation for Kinetix TL and TLY Motor Power Cables

2090-CPBM6DF motor power cables, used with Kinetix TLY motors, require no preparation. However, 2090-DANPT-16Sxx power cables, used with Kinetix TL motors, have a short pigtail cable that connects to the motor, but is not shielded. The preferred method for grounding the Kinetix TL power cable on the motor side is to expose a section of the cable shield and clamp it directly to the machine frame.

The motor power cable also has a 150 mm (6 in.) shield termination wire with a ring lug that connects to the closest earth ground. The termination wire can be extended to the full length of the motor pigtail if necessary, but it is best to connect the supplied wire directly to ground without lengthening.

---

**IMPORTANT** For Kinetix TL motors, connect the 150 mm (6.0 in.) termination wire to the closest earth ground.

---

**Figure 47 - 2090-DANPT-16Sxx Cable Preparation**

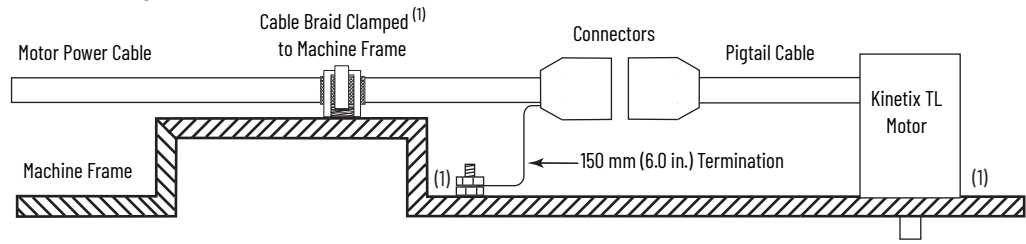

(1) Remove paint from machine frame to provide HF-bond between machine frame, motor case, shield clamp, and ground stud.

## Apply the Motor Power/brake Shield Clamp

The power/brake cable shield attaches to the drive cable clamp. A clamp spacer is included with the connector set included with the drive, for cable diameters that are too small for a tight fit within the drive clamp alone.



**SHOCK HAZARD:** To avoid the hazard of electrical shock, make sure that shielded power cables are grounded according to recommendations.

Follow these steps to apply the motor power/brake shield clamp.

1. Position the motor power cable shield within the shield clamp.  
If the cable is too small in diameter to fit tight in the standard shield clamp, add the clamp spacer.  
Skip to [step 4](#) for frame 3 drives with large cable diameters.
2. Make sure that the cable clamp tightens around the cable shield and provides a high-frequency bond between the cable shield and the drive chassis.

---

**IMPORTANT** Loosen the screw, if needed, until you can start threading both clamp screws with the cable shield under the clamp.

---

3. Tighten each screw, a few turns at a time, until the maximum torque value of 2 N•m (17.7 lb•in) is achieved.
4. For frame 3 drives only, if the cable is too large to fit within the standard shield clamp, substitute the standard clamp for the frame 3 clamping plate.
5. Apply two tie wraps around the cable shield and clamping plate (see [Figure 48](#) on [page 88](#) for example) to provide a high-frequency bond between the cable shield and the drive chassis.

---

**IMPORTANT** If the power/brake cable shield has a loose fit inside the shield clamp, insert the clamp spacer between the shield clamp and the drive to reduce the clamp diameter. When the clamp screws are tight, 2.0 N•m (17.7 lb•in), the result must be a high-frequency bond between the cable shield and the drive chassis.  
If the frame 3 cable is too large to fit within the standard shield clamp, substitute the standard clamp for the frame 3 clamping plate. Apply two tie wraps around the cable shield and plate to provide a high-frequency bond between the cable shield and the drive chassis.

---

See [Figure 48](#) on [page 88](#) for a cable-clamp attachment illustration.

Figure 48 - Cable Clamp Attachment

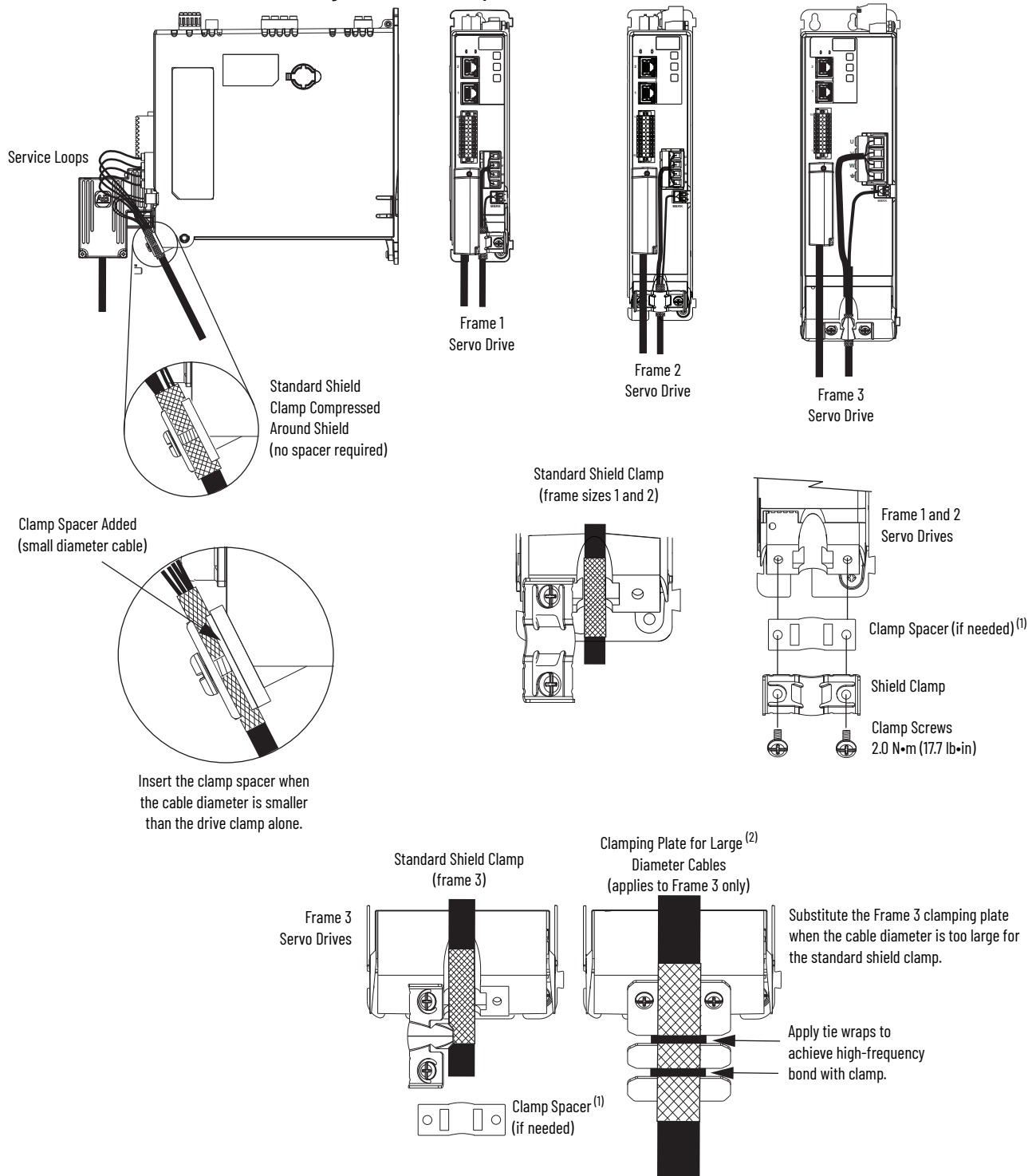

(1) The clamp spacer is included in 2198-CONKIT-PWRxx connector sets with frame 1, 2, and 3 drives.  
 (2) The clamping plate is included in only the 2198-CONKIT-PWR75 connector set with frame 3 drives.



## Wire the Motor Feedback Connector

Motor feedback connections are made at the motor feedback (MFB) 15-pin connector on the front of the drive. This section provides examples and guidelines to assist you in making these connections. Included are wiring examples for motor encoders that require battery backup.

All current and legacy feedback cables that are listed in the following table are compatible with the 2198-K53CK-D15M connector kit.

**Table 48 - Motor Feedback Cable Compatibility**

Motor/Actuator Cat. No.	Feedback Cable Cat. No.
MPL-A/B15xxx-V/Ex7xAA, MPL-A/B2xxx-V/Ex7xAA MPL-A/B3xxx-S/Mx7xAA, MPL-A/B4xxx-S/Mx7xAA MPL-A/B45xxx-S/Mx7xAA, MPL-A/B5xxx-S/Mx7xAA MPL-B6xxx-S/Mx7xAA, MPL-B8xxx-S/Mx7xAA, MPL-B9xxx-S/Mx7xAA	2090-CFBM7DF-CEAAxx 2090-CFBM7DD-CEAAxx 2090-CFBM7DF-CERAxx (standard) or 2090-CFBM7DF-CEAFxx 2090-CFBM7DD-CEAFxx 2090-CFBM7DF-CDAFxx (continuous-flex)
MPM-A/Bxxxx-S/M MPF-A/Bxxxx-S/M MPS-A/Bxxxx-S/M	
MPAR-A/B1xxx-V and MPAR-A/B2xxx-V (series B) MPAR-A/B3xxx-M MPAI-A/BxxxxM3	
MPAS-A/Bxxxx1-V05xA (ballscrew) MPAS-A/Bxxxx2-V20SxA (ballscrew)	
LDAT-Sxxxxxx-xDx	
MPL-A/B15xxx-Hx7xAA MPL-A/B2xxx-Hx7xAA MPL-A/B3xxx-Hx7xAA MPL-A/B4xxx-Hx7xAA MPL-A/B45xxx-Hx7xAA	2090-XXNFMF-Sxx (standard) or 2090-CFBM7DF-CDAFxx (continuous-flex)
MPAS-A/Bxxxx-ALMx2C (direct-drive)	
LDAT-Sxxxxxx-xBx	
LDC-Cxxxxxx-xH LDL-xxxxxx-xH	
TLP-A046-xxx, TLP-A/B070-xxx, TLP-A/B090-xxx, TLP-A100-xxx	2090-CTFB-MADD-CFAxx (standard) or 2090-CTFB-MADD-CFFxx (continuous-flex)
TLP-A/B115-xxx, TLP-A/B145-xxx, TLP-A/B200-xxx, TLP-A/B235-xxx	2090-CTFB-MFDD-CFAxx (standard) or 2090-CTFB-MFDD-CFFxx (continuous-flex)
TLY-Axxxx-B	2090-CFBM6DF-CBAxx (standard)
TLY-Axxxx-H	2090-CFBM6DD-CCAxx (standard)
TL-Axxxx-B	2090-DANFCT-Sxx (standard)

**Table 49 - Legacy Motor Feedback Cables**

Motor Cable	Description	Feedback Cable Cat. No.
Standard	Encoder feedback, threaded	2090-XXNFMF-Sxx 2090-UXNFBMF-Sxx
	Encoder feedback, bayonet	2090-UXNFBMP-Sxx 2090-XXNFMP-Sxx
Continuous-flex	Encoder feedback, bayonet	2090-XTFMP-Sxx
	Encoder feedback, threaded	2090-CFBM4DF-CDAFxx

## Cable Preparation for Kinetix TLP Feedback Cables

For Kinetix TLP motors, 2090-CTFB-MxDD feedback cables (with battery box) are available for applications with and without the need for battery backup.

- For multi-turn feedback, use 2090-CTFB-MxDD cables with drive-end connector plugs and wire the battery box (included with each Kinetix TLP feedback cable) and install a customer-supplied battery. See Feedback Battery Box Installation Instructions, publication [2198-INO22](#), for more information.
- For single-turn feedback, use 2090-CTFB-MxDD cables with drive-end connector plugs, however, the battery box option is not required.
- If you build your own cables, see Build Your Own Kinetix TLP Motor Cables Installation Instructions, publication [2090-INO48](#), and make flying-lead feedback connections to the 2198-K53CK-D15M connector kit.

**Figure 49 - Battery Box Wired With Battery**

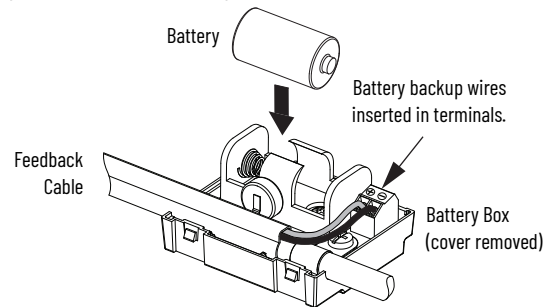

## Cable Preparation for 2090-CFBM7Dx Feedback Cables

2090-CFBM7DD motor feedback cables, used with Kinetix MP motors and actuators (with Hiperface encoders), also provide a drive-end connector that plugs directly into the 15-pin Kinetix 5300 (MFB) feedback connector. Use the 2198-K53CK-D15M feedback connector kit with 2090-CFBM7DF flying-lead cables.

## Cable Preparation for Kinetix TL and TLY Feedback Cables

For Kinetix TLY motors, 2090-CFBM6Dx feedback cables are available for applications with and without the need for battery backup.

- For multi-turn encoders (TLY-Axxxx-B motors), use the 2198-K53CK-D15M feedback connector kit (with customer-supplied battery) and 2090-CFBM6DF flying-lead cables.
- For incremental encoders (TLY-Axxxx-H motors), use 2090-CFBM6DD cables with a drive-end connector and plug directly into the 15-pin (MFB) feedback connector.
  - If the 2090-CFBM6DF flying-lead cable is preferred, the 2198-K53CK-D15M connector kit (without battery) can also be used.

For Kinetix TL-Axxxx-B motors, use 2090-DANFCT-Sxx feedback cables. You must remove the drive-end connector and prepare the leads for terminating at the 2198-K53CK-D15M connector kit. Install a (customer-supplied) battery for multi-turn encoder position backup.

**Figure 50 - Feedback Connection for Kinetix TL Motors**

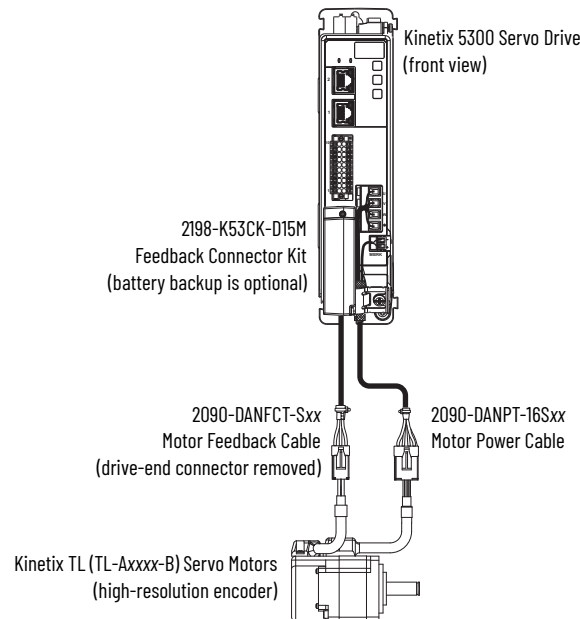

## Motor Feedback Cable Preparation

When using the 2198-K53CK-D15M feedback connector kit, you must prepare the Kinetix 2090 flying-lead conductors with the proper strip length. The cable shield requires a high-frequency bond with the ground pad.

Follow these steps to prepare feedback cables.

1. Remove 110 mm (4.3 in.) of cable jacket and 97 mm (3.8 in.) of cable shield.

---

**IMPORTANT** This length of wire is needed for the longest wires that are terminated at each 8-pin connector. However, most wires are trimmed shorter, depending on the terminal they are assigned to.

---

2. Determine the length for each wire and trim as necessary.
3. Remove 5 mm (0.2 in.) of insulation from the end of each wire.

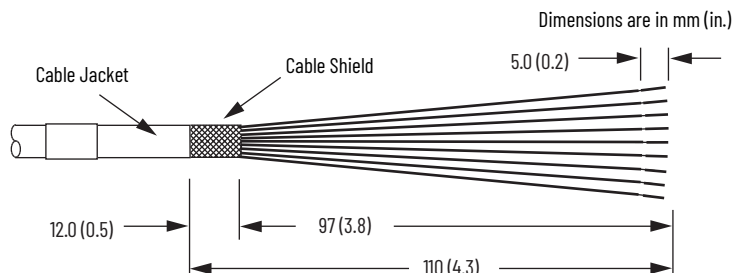

### Apply the Connector Kit Shield Clamp

Follow these steps to apply the connector kit shield clamp.

1. To achieve a high-frequency bond, position the 12 mm (0.5 in.) of exposed cable shield over the ground pad.

---

**IMPORTANT** Cable preparation and positioning that provides a high-frequency bond between the shield braid and clamp is required to optimize system performance. Also, make sure that the cable is positioned where the cover clamps onto the jacket for added stress relief.

---

2. Place the shield clamp over the cable shield and install the clamp screws. Apply 0.34 N•m (3 lb•in) torque to each screw.

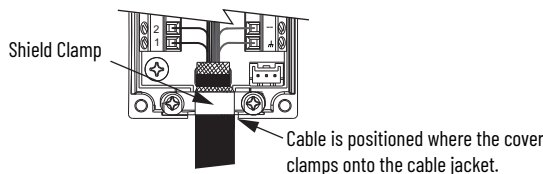

3. Route and insert each wire to its assigned terminal, apply 0.22 N•m (1.9 lb•in) to 0.25 N•m (2.2 lb•in) maximum torque to each screw. See the connector pinout as shown in [Figure 51](#) on [page 95](#).
4. Attach the tie wrap (customer-supplied) through the slots and around the cable shield for stress relief and to create a high-frequency bond between shield and ground pad.

## Kinetix 2090 Feedback Cable Pinouts

The following tables provide motor connector pinouts and wire colors to the 2198-K53CK-D15M connector kit.

Table 50 - 2090-CFBM7DF-CEAxxx Feedback Cables

Absolute, High-resolution Feedback	MPL-B15xxx and MPL-B2xxx-V/Ex4/7xAA MPL-B3xxx...MPL-B9xxx-M/Sx7xAA MPL-A5xxx-M/Sx7xAA	MPL-A15xxx and MPL-A2xxx-V/Ex4/7xAA MPL-A3xxx-M/Sx7xAA MPL-A4xxx-M/Sx7xAA MPL-A45xxx-M/Sx7xAA	Wire Color	2198-K53CK-D15M Connector Kit Pin
Motor/Actuator Pin	MPM-A165xxx...MPM-A215xxx-M/S MPM-Bxxxxx-M/S MPF-Bxxx-M/S MPF-A5xxx-M/S MPS-Bxxx-M/S	MPM-A115xxx...MPM-A130xxx-M/S MPF/MPS-A3xx-M/S MPF/MPS-A4xx-M/S MPF/MPS-A45xx-M/S		
	MPAS-Bxxxxx-VxxSxA MPAR-Bxxxx, MPAI-Bxxxx LDAT-Sxxxxxx-xDx	MPAS-Axxxxx-VxxSxA MPAR-Axxxx, MPAI-Axxxx		
1	SIN+	SIN+	Black	1
2	SIN-	SIN-	White/Black	2
3	COS+	COS+	Red	3
4	COS-	COS-	White/Red	4
5	DATA+	DATA+	Green	5
6	DATA-	DATA-	White/Green	10
9	Reserved	EPWR_5V	Gray	14
10	ECOM	ECOM	White/Gray	6 <sup>(1)</sup>
11	EPWR_9V	Reserved	Orange	7
13	TS+	TS+	White/Orange	11

(1) The ECOM and TS- connections are tied together and connect to the cable shield.

Table 51 - 2090-CTFB-MxDD-CFxxx Feedback Cables

Motor Pin	TLP-Axxx-xxx and TLP-Bxxx-xxx 24-bit Absolute, Multi-turn/Single-turn High-resolution	Wire Color	2198-K53CK-D15M Connector Kit Pin
A	T+	White	5
B	T-	White/Red	10
C	BAT+	Red	Pin +
D	BAT-	Black	Pin -
L	Drain	—	
R	ECOM	Blue	6
S	EPWR_5V	Brown	14

**Table 52 - 2090-XXNFMF-Sxx or 2090-CFBM7DF-CDAXxx Feedback Cables**

Incremental Feedback	MPL-A/B15xxx...MPL-A/B2xxx-Hx4/7xAA MPAS-A/Bxxxx-ALMx2C	Wire Color	2198-K53CK-D15M Connector Kit Pin
Motor/Actuator Pin	LDAT-Sxxxxxx-xBx LDC-Cxxxxxx-xH, LDL-xxxxxx-xH		
1	SIN+	Black	1
2	SIN-	White/Black	2
3	COS+	Red	3
4	COS-	White/Red	4
5	DATA+	Green	5
6	DATA-	White/Green	10
9	EPWR_5V	Gray	14
10	ECOM	White/Gray	6 <sup>(1)</sup>
11	EPWR_9V	Orange	7
13	TS+	White/Orange	11
15	S1	White/Blue	12
16	S2	Yellow	13
17	S3	White/Yellow	8

(1) The ECOM and TS- connections are tied together and connect to the cable shield.

**Table 53 - 2090-CFBM6DF-CBAAXx Feedback Cables**

Motor Pin	TLY-Axxxx-H Incremental Encoder Feedback	Wire Color	2198-K53CK-D15M Connector Kit Pin
9	AM+	Black	1
10	AM-	White/Black	2
11	BM+	Red	3
12	BM-	White/Red	4
13	IM+	Green	5
14	IM-	White/Green	10
22	EPWR_5V	Gray	14
23	ECOM	White/Gray	6 <sup>(1)</sup>
15	S1	White/Blue	12
17	S2	Yellow	13
19	S3	White/Yellow	8
24	Drain	—	$\frac{1}{\text{---}}$

(1) The ECOM and TS- connections are tied together and connect to the cable shield.

Table 54 - 2090-CFBM6DF-CBAxx Feedback Cables

Motor Pin	TLY-Axxxx-B 17-bit Absolute, Multi-turn, High-resolution Feedback	Wire Color	2198-K53CK-D15M Connector Kit Pin
13	DATA+	Green	5
14	DATA-	White/Green	10
22	EPWR_5V	Gray	14
23	ECOM and BAT-	White/Gray	6 <sup>(1)</sup>
6	BAT+	Orange	BAT+
24	Drain	—	⏏

(1) BAT- is tied to ECOM (pin 23) in the cable.

Table 55 - 2090-DANFCT-Sxx Feedback Cables

Motor Pin	TL-Axxxx-B 17-bit Absolute, Multi-turn, High-resolution Feedback	Wire Color	2198-K53CK-D15M Connector Kit Pin
12	SD+	Brown	5
13	SD-	White/Brown	10
7	EPWR_5V	Gray	14
8	ECOM and BAT-	White/Gray	6 <sup>(1)</sup>
14	BAT+	Orange	BAT+
9	Drain	—	⏏

(1) BAT- is tied to ECOM (pin 8) in the cable.

Figure 51 - Wire the 2198-K53CK-D15M Feedback Connector Kit

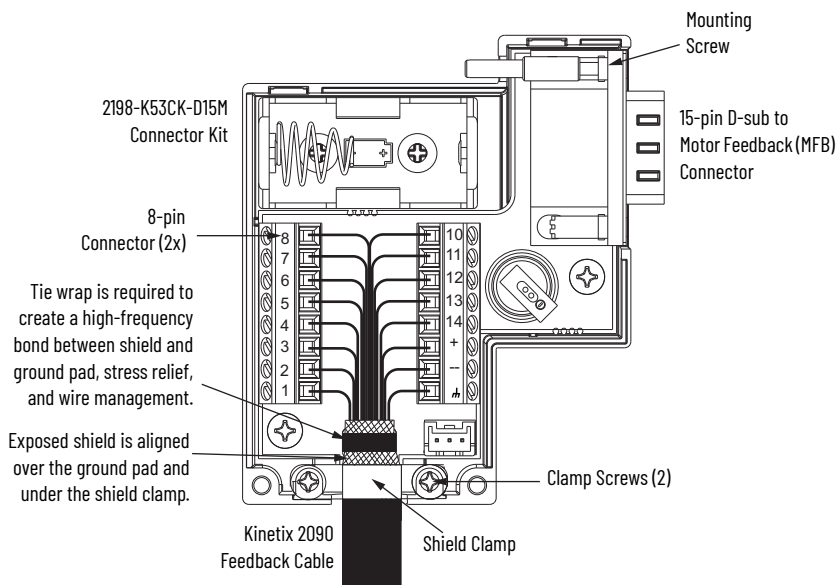

For more information on wiring the 2198-K53CK-D15M, see Kinetix 5300 Feedback Connector Kit Installation Instructions, publication [2198-IN023](#).

Terminal	Signal	Wire Color
1	SIN+   AM+	Black
2	SIN-   AM-	White/Black
3	COS+   BM+	Red
4	COS-   BM-	White/Red
5	DATA+   IM+	Green
6	ECOM <sup>(1)</sup>	White/Gray
7	EPWR_9V	Orange
8	S3	White/Yellow
10	DATA-   IM-	White/Green
11	TS+	White/Orange
12	S1	White/Blue
13	S2	Yellow
14	EPWR_5V	Gray
+	Battery +	— <sup>(2)</sup>
-	Battery -	— <sup>(2)</sup>
⏏	Drain	Shield

(1) The ECOM and TS- connections are tied together and connect to the cable shield.  
 (2) See cable pinouts for wire colors.

## External Passive-shunt Resistor Connections

Passive shunt connections are made at the shunt connector on the top of the drive.

Follow these guidelines when wiring your 2097-Rxxx shunt resistor:

- For noise zone considerations, refer to [External Passive Shunt Resistor on page 39](#).
- See [Shunt Resistor Wiring Example on page 172](#).
- See the installation instructions provided with your Bulletin 2097 shunt resistor, publication [2097-IN002](#).

**IMPORTANT** To improve system performance, run wires and cables in the wireways as established in [Chapter 2](#).

Figure 52 - Shunt Connector Wiring

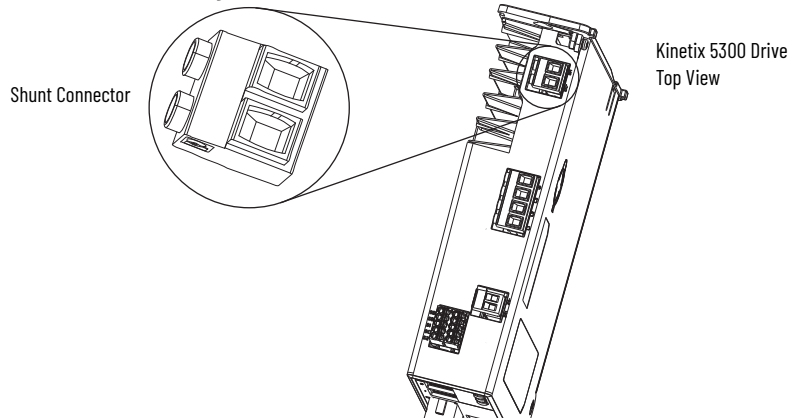

Table 57 - Shunt Resistor Connector Specifications

Drive Cat. No.	Pin <sup>(1)</sup>	Signal	Recommended Wire Size mm <sup>2</sup> (AWG)	Strip Length mm (in.)	Torque Value N•m (lb•in)
2198-Cxxxx-ERS	—	DC+ SH	0.2...2.5 (24...12)	8.0 (0.31)	0.5...0.6 (4.4...5.3)

(1) Pin numbering is not used on the shunt connector. Making shunt connections to the 2-pin connector is arbitrary.

**IMPORTANT** You must unplug the internal shunt connector plug before connecting the external shunt-resistor wires. Use the spare shunt connector plug provided with the drive for the external shunt.



**ATTENTION:** Your internal or external passive shunt requires configuration in the Logix Designer application. Failure to properly configure the shunt can result in reduced performance or shunt resistor damage. For Module Properties > Power category configuration, see [Continue Drive Configuration on page 112](#).



## Ethernet Cable Connections

This procedure assumes that the Logix 5000® controller and Kinetix 5300 drives are mounted and are ready for you to connect the network cables.

The EtherNet/IP™ network is connected by using the PORT 1 and PORT 2 connectors.

- To locate the Ethernet connectors on your Kinetix 5300 drive, refer to [Figure 26 on page 52](#).
- To locate the connectors on your Logix 5000 controller, refer to [Figure 53](#) on this page.

Shielded Ethernet cable is required and available in several standard lengths. Ethernet cable lengths connecting drive-to-drive, drive-to-controller, or drive-to-switch must not exceed 100 m (328 ft). See the Kinetix Rotary and Linear Motion Cable Specifications Technical Data, publication [KNX-TD004](#), for more information.

**Figure 53 - ControlLogix and CompactLogix Ethernet Port Locations**

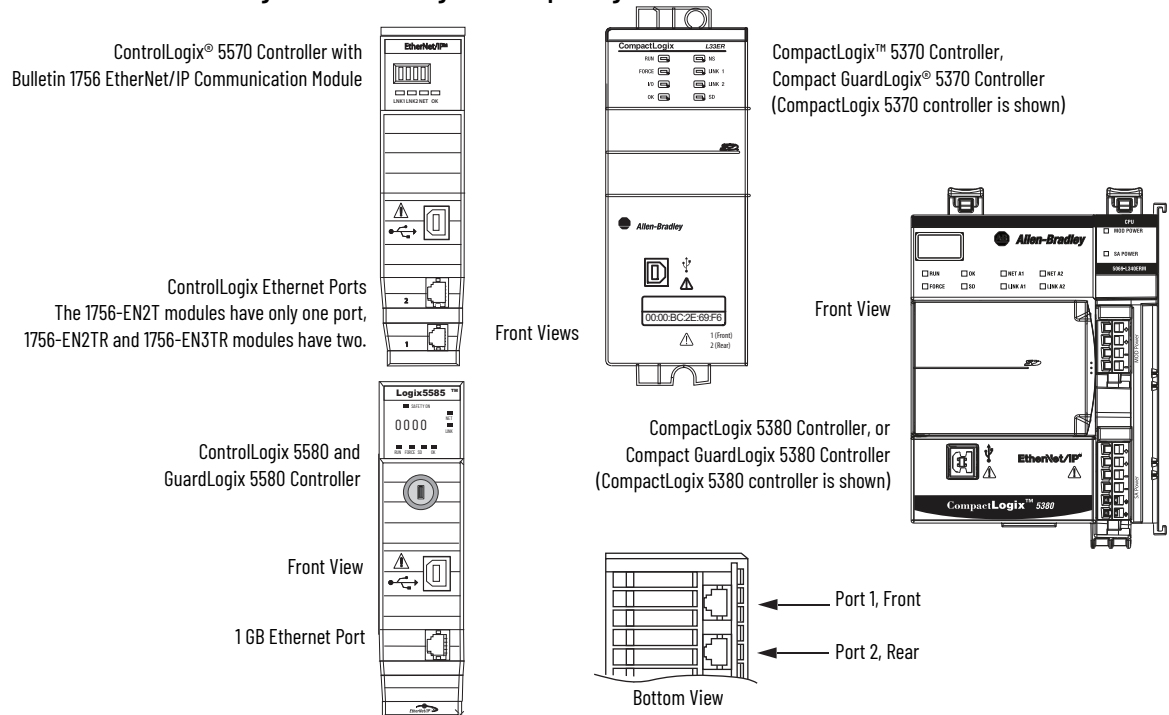

These Logix 5000 controllers accept linear, ring (DLR), and star network configurations. For linear, ring, and star configuration examples, refer to [Typical Communication Configurations on page 19](#).

**IMPORTANT** When using an external Ethernet switch for routing traffic between the controller and the drive, switches with IEEE-1588 time synchronization capabilities (boundary or transparent clock) must be used to make sure that switch delays are compensated.

**Notes:**

## Configure and Start Up the Kinetix 5300 Drive System

This chapter provides procedures for configuring your Kinetix® 5300 drive system with a Logix 5000® controller.

Topic	Page
Understand the Kinetix 5300 Front Panel	99
Configure the Kinetix 5300 Drive	105
Studio 5000 Logix Designer	106
Studio 5000 Logix Designer	106
Configure the Logix 5000 Controller	107
Configure the Kinetix 5300 Drive Modules	110
Configure the Motion Group	115
Configure Vertical Load Control Axis Properties	116
Configure Feedback-only Axis Properties	116
Configure Induction-motor Frequency-control Axis Properties	118
Configure SPM Motor Closed-loop Control Axis Properties	122
Configure Induction-motor Closed-loop Control Axis Properties	128
Configure Feedback Properties	133
Apply Power to the Kinetix 5300 Drive	137
Test and Tune the Axes	138



Before you begin make sure that you know the catalog number for the drive, the Logix 5000 controller, and the servo motor/actuator in your motion control application.

### Understand the Kinetix 5300 Front Panel

The Kinetix 5300 drive has two status indicators, four Ethernet status indicators, and a four-character status display on the front panel as shown [Figure 54](#). These status indicators and the display are used to monitor the system status, activity, and indicate faults.

The four-character status display has three navigation pushbuttons that are used to select and edit a limited set of information. The home screen provides a scrolling message of basic information, and the menus can be accessed by using the Next, Select, and Back buttons. See [Figure 54](#) for descriptions and functions.

Figure 54 - Kinetix 5300 Front Panel Identification

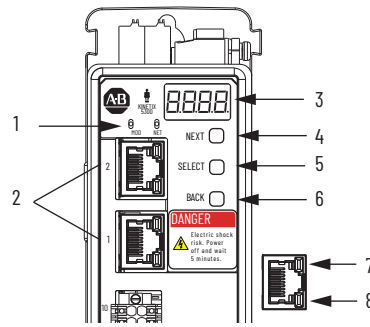

Item	Description	Function
1	Module and Network status indicator <sup>(1)</sup>	Used to indicate the connectivity of the module and network.
2	Ethernet Ports (RJ45 connector)	Used to connect the drive to the Ethernet network.
3	Four-character status display	Used to display the editable menu for the Kinetix 5300 drive.
4	Next	Used to advance to the next selection in an editable string.
5	Select	Used to select a menu item for editing.
6	Back	Used to return to the previous editable character in an editable string or to return to the previous menu.
7	Link speed status indicators <sup>(1)</sup>	Used to indicate network speed status and communication status.
8	Link/Activity status indicators <sup>(1)</sup>	

(1) For additional information about status indicators and fault codes, refer [Interpret Status Indicators on page 141](#).

## Menus and Display Screen

The alphanumeric four-character status display scrolls messages and menu selections. The display has a nested menu structure that contains a Home screen and displays drive information, settings, and faults. The Home screen scrolls the CIP™ state and IP address during normal operation. When a fault occurs, the active fault code is displayed.

### Character Identification

The status display uses seven-segment characters. [Figure 55](#) represents the alphanumeric characters that are used for the four-character status display.



Figure 55 - Status Display Character Code

0	1	2	3	4	5	6	7	8	9			
0	1	2	3	4	5	6	7	8	9			
A	B	C	D	E	F	G	H	I	J	K	L	M
A	b	C	d	E	F	G	H	I	J	K	L	█
N	O	P	Q	R	S	T	U	V	W	X	Y	Z
no	P	█	r	S	t	U	█	█	█	█	Y	Z



The letters K, M, Q, V, W, and X are not available.

### Navigating the Display Screen

You can use the navigation buttons (Next, Select, and Back) to view the menus, access information, and make changes within the display menus.

- From the Home screen, press Next to enter the main menu.
- Press Select to enter a specific menu.
- Press Next to scroll through the main menu and submenu items.
- Press Back to return to the previous menu or repeatedly to return to the Home screen.
- Press Select when *ACCEPT* is displayed to apply your changes and return to the submenu.



When viewing the four-character status display, the selected option scrolls across the display using the seven-segment characters shown in [Figure 55](#). Within the procedures to configure and start up the drive, standard text is used to describe the options.

### Menu Structure

The menu structure of the Kinetix 5300 drive has a main menu and submenus. [Table 58](#) defines the menu structure of the four-character status display. [Figure 56](#) shows a graphical representation of how the menus interact.

**Table 58 - Status Display Menu Structure**

Main Menu	Submenu	Confirmation	Select/Next Screen	Default	Description <sup>(1)(2)</sup>
Info <sup>(3)</sup>	Catalog Number	-		-	Drive catalog number
	Version				Firmware revision
	Bus Voltage				DC Bus Voltage Value
IP Settings <sup>(4)</sup>	IP Address	Accept <sup>(5)</sup>	IP Address	192.168.1.1	Current IP address
	Subnet		Subnet	255.255.255.000	Current subnet mask
	Gate		Gate	192.168.001.254	Current gateway
DHCP	On DHCP	Accept	DHCP On	ON	Turns DHCP ON
	Off DHCP	Accept	DHCP Off		Turns DHCP OFF
HTTP Access	On HTTP Access	Accept	HTTP Access On	OFF	Enables the web server
	Off HTTP Access	Accept	HTTP Access Off		Disables the web server
Protected Net	On Protected Net	Accept	Protected Net On	ON	When enabled (default), network configuration changes are not possible when a controller connection is open.
	Off Protected Net	Accept	Protected Net Off		
Protected Unit	On Protected Unit	Accept	Protected Unit On	OFF	When enabled (default), the only attribute writes are possible when a controller connection is open.
	Off Protected Unit	Accept	Protected Unit Off		
Factory Reset	-	Accept <sup>(6)</sup>	-	-	When selected, resets the drive back to the factory defaults.

(1) On/Off menus use dashes (example: *-ON-*) to indicate which option is active.

(2) If any changes are made to the submenus, cycle 24V power for the change to take effect.

(3) *INFO* does not have a confirmation screen, to return to the main menu, press Back until *INFO* appears.

(4) The defaults that are listed only apply if DHCP is turned *OFF*.

(5) If an Error or Fault Code occurs (*NET ERR*), the previous screen is displayed.

(6) If the Factory Reset fails, the main menu is displayed.

**IMPORTANT** Press Select when the *ACCEPT* confirmation screen is displayed to apply your changes. If the system is left unattended or if *ACCEPT* is not selected, the system times out and returns the display to the Home screen without saving changes.



**ATTENTION:** Risk of personal harm and equipment damage is possible. Voltage over 50V is present if three-phase power is applied. Disconnect three-phase power and wait 5 minutes before interacting with the drive or removing the 24V plug.

Figure 56 - Status Display Screen Flowchart

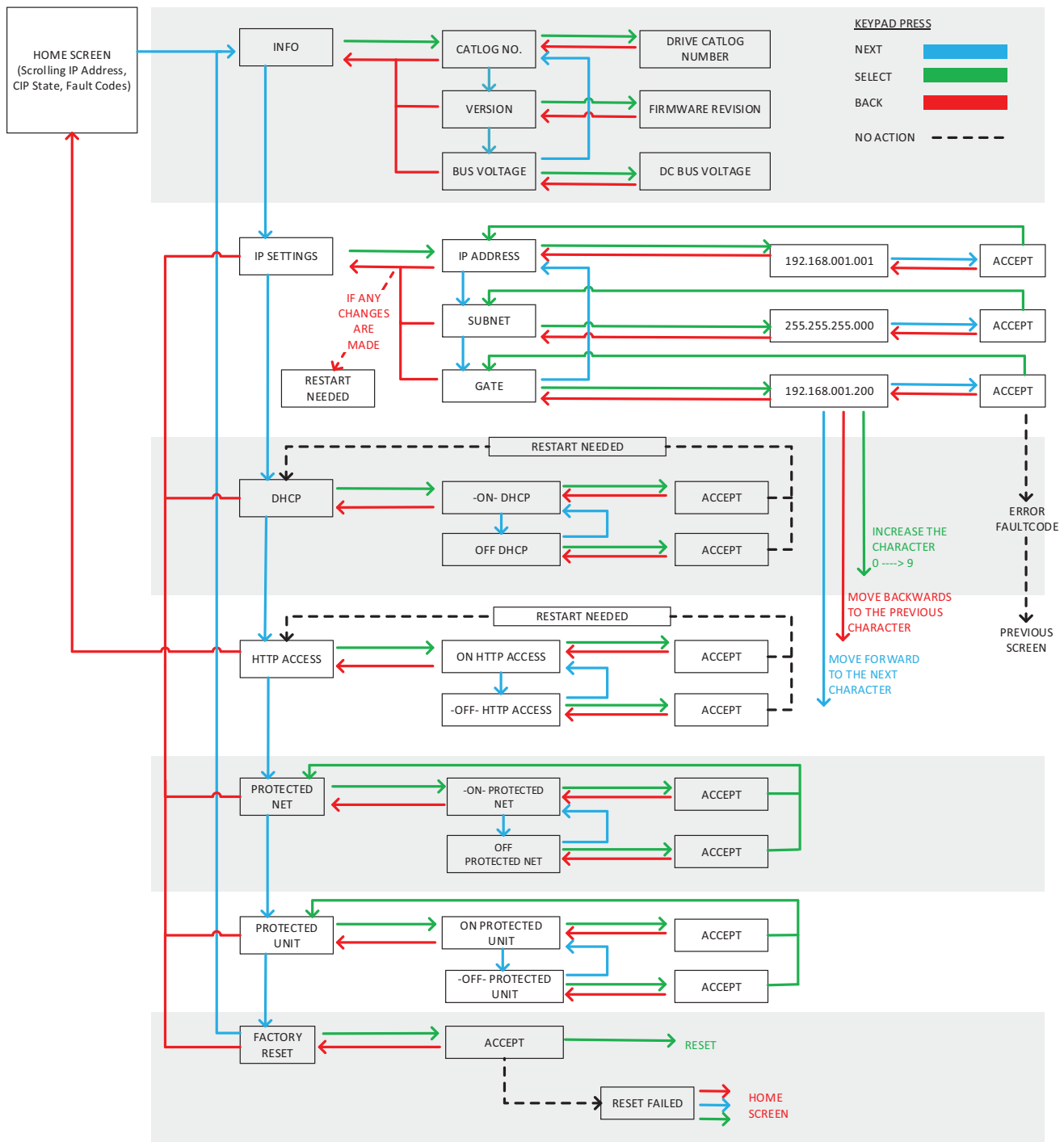

View the DC Bus Voltage

1. From the Home screen, press Next to access the main menu.
2. With the *INFO* screen active, press Select to view to the submenus.
3. Press Next to scroll through the submenu until *BUS VOLTAGE* is displayed.
4. With *BUS VOLTAGE* displayed, Press Select to view the current DC Bus Voltage value.
5. To return to the Home Screen, press the Back button until the Home screen appears.

### Change the DHCP Setting

DHCP is enabled by default, follow these steps to disable DHCP.

1. From the Home screen, press Next to access the main menu.
2. Press Next to scroll through the submenu until *DHCP* is displayed.
3. Press Select to choose the *DHCP* submenu.
4. Press Next to scroll through the *DHCP* submenu.
5. Press Select to choose *ON* or *OFF*.



The active selection is displayed with dashes surrounding "ON" or "OFF" (for example, -ON-).

6. When *ACCEPT* is displayed, press Select to accept the modification and return to the *DHCP* menu.



Cycle 24V power for changes to take effect.

### Change the IP Settings

Follow these steps to update the network settings.

1. From the Home Screen, press Next to access the main menu.
2. Press Next to scroll through the main menu until *IP SETTINGS* is displayed.
3. Press Select to choose *IP SETTINGS*.
4. Within the *IP SETTINGS* menu, press Next to navigate the submenu: *IP ADDRESS*, *SUBNET*, or *GATE*.
5. Press Select to choose the desired network setting.  
Within the setting, if the character is editable, the character blinks.
  - a. Press Select to increment the active character to the desired number.
  - b. Press Next to move to the next character.
  - c. Press Back to move to the previous character.
6. After modifying the last character, press Next.  
The display now shows *ACCEPT*.
7. Press Select to accept the modification and return to the *IP SETTINGS* submenu.



If necessary, update all network settings by repeating [step 4](#)...[step 7](#) before validating the changes.

8. Press Back to validate the configured network settings.

---

**IMPORTANT** *Net Err* is displayed if any of the network settings are incompatible (or Protected Net is set to ON). Review your network settings and make sure they are compatible (or Protected Net is set to OFF). The IP and Gateway addresses must be on the same Subnet.

---

9. Cycle 24V power to apply the network setting changes.

### Startup Sequence

The screen displays *BOOT* at startup, followed by 5300. Dot segments are used to represent the start-up progress. After completion of each start-up phase, a new dot lights from left to right. As shown in [Figure 57](#), the display changes progressively from 5.300 to 5.3.0.0.

After startup, the drive performs a self-test. The display shows 8.8.8.8 during this process. Next, the device state and the MAC or IP address of the device are scrolled across the display. [Figure 57](#) shows the display screen sequence.

**Figure 57 - Startup Display Sequence**

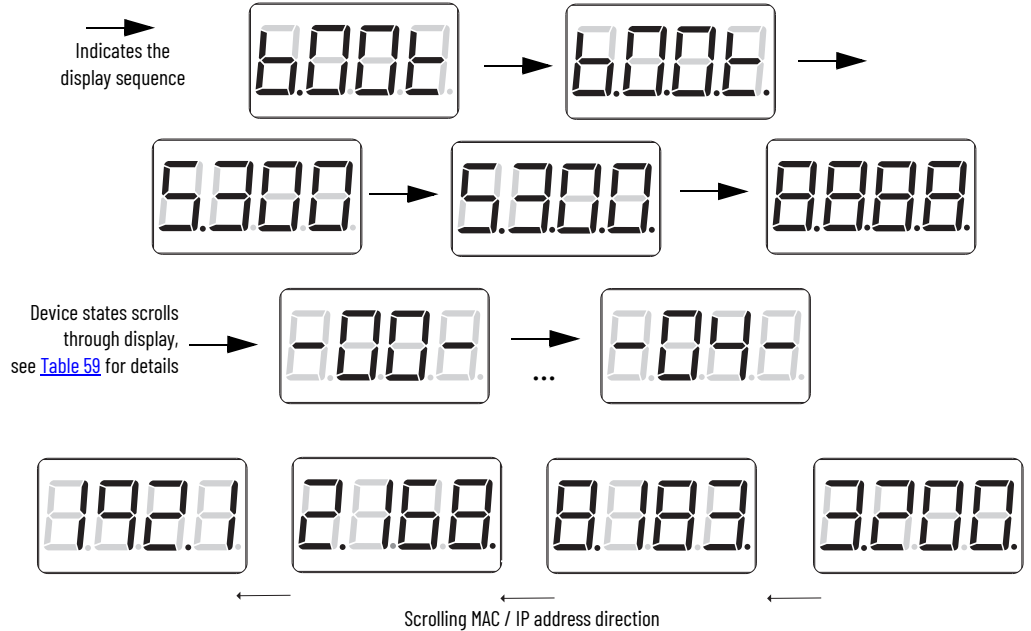

The device state corresponds to the drive being operational. [Table 59](#) lists the device states and their descriptions.

**Table 59 - Four-character Display Axis and Status Device States**

Display Digits	Device Condition
8888	Executing device self-test
00	Waiting for connection to controller
01	Configuring device attributes
02	Waiting for group synchronization
03	Waiting for DC-bus to charge
04	Device is operational



## Configure the Kinetix 5300 Drive

You can include the drive in your Studio 5000 Logix Designer® application by adding it to a configured EtherNet/IP™ module or controller under the I/O configuration tree. After setting network parameters, you can view the drive status information in the Studio 5000 Logix Designer application and use it in your Logix controller application.

### Set the Network Parameters

There are two methods of configuring an IP address.

- An address can be assigned to the drive automatically (dynamic IP address) when the drive is connected to a DHCP (Dynamic Host Configuration Protocol) enabled server
- You can manually assign an IP address to the drive (static IP address)

#### *Dynamic IP Address Allocation*

When the Kinetix 5300 drive is connected to a network domain with a DHCP enabled server, the IP address of the drive is assigned automatically. To enable automatic assignment, the drive must have its DHCP mode enabled. The default factory setting has DHCP mode enabled.

---

**IMPORTANT** If a DHCP server has not assigned an IP address to the drive, and the drive has DHCP mode enabled, the main menu scrolls the MAC address of the drive.

---

#### *Static IP Address Allocation*

When the drive is connected to a network domain without an enabled DHCP server, the IP address of the drive must be assigned manually. To use a manually assigned IP address, the drive DHCP mode must be disabled.

See [Change the DHCP Setting](#) for instruction on how to disable DHCP. [Table 60](#) shows the drive defaults. For additional information on navigating the four-character status display menu structure, see [Figure 56](#).

**Table 60 - Static IP Default Settings**

Type		Default
IP Settings <sup>(1)</sup>	IP Address	192.168.1.1
	Subnet	255.255.255.000
	Gate	192.168.001.001
DHCP	ON DHCP	ON DHCP
	OFF DHCP	
HTTP Access	ON HTTP ACCESS	OFF HTTP ACCESS
	OFF HTTP ACCESS	
Protected Net	ON PROTECTED NET	ON PROTECTED NET
	OFF PROTECTED NET	
Protected Unit	ON PROTECTED UNIT	OFF PROTECTED UNIT
	OFF PROTECTED UNIT	

(1) The defaults that are listed only apply if DHCP is turned OFF.

Use the four-character display and menus to set the network settings. See [Change the IP Settings](#) on [page 103](#) for instructions to update the following:

- IP address
- Subnet mask
- Gateway

- 
- IMPORTANT**
- Modified address octets must be within a valid range (0...255). The first digit of every octet has a range of 0...2. Every other digit has a range of 0...9. When a digit is incremented over the upper boundary, the digit resets to 0.
  - If a modified network setting is invalid, *NET ERR* is displayed and you must manually revert to the previous network settings.
  - If a modified network setting is valid, *ACCEPT* is displayed. Press Select to confirm the new setting.
  - After you modify and confirm a network setting, press Back to apply the settings.
- 

Settings are stored in nonvolatile memory. IP addresses can also be changed through the Module Configuration dialog box in RSLinx® software. Changes to the IP address take effect after the power is cycled.

## Studio 5000 Logix Designer

For help with using the Studio 5000 Logix Designer application as it applies to configuring the ControlLogix® or CompactLogix™ controllers, see [Additional Resources on page 10](#).

### Version History

Each release of the Studio 5000 Logix Designer application makes it possible for the configuration of additional Kinetix motors, actuators, or other drive features not available in previous versions.

- 
- IMPORTANT** To configure additional drive features and/or motors with your Kinetix 5300 servo drive, you must have drive firmware 13.001 or later.
- 

**Table 61 - Add-On Profile (AOP) Installation Requirement**

Drive Catalog Number	Drive Firmware Revision	Logix Designer Application Version	Kinetix 5300 AOP Needed?
2198-Cxxxx-ERS	13.001 or later	33.00 or later	No

## Install the Kinetix 5300 Add-On Profile

Download AOPs from the Product Compatibility Download Center (PCDC) website: [rok.auto/pcdc](http://rok.auto/pcdc).

Follow these steps to download the Kinetix 5300 Add-On Profile.

1. Go to the Product Compatibility Download Center. The Compatibility & Downloads webpage appears.
2. Click Download.

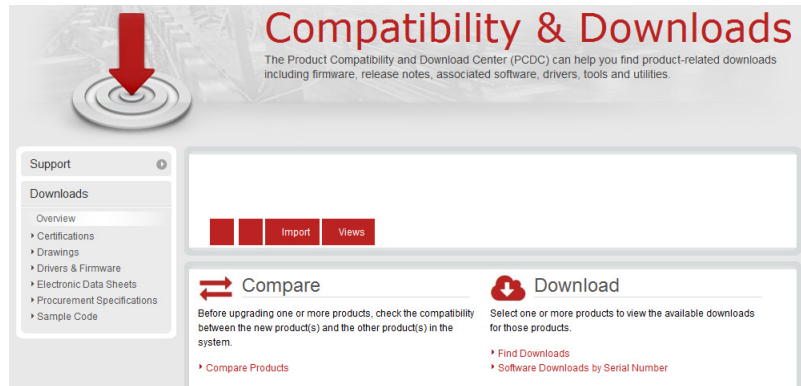

3. Enter Kinetix 5300 in the Search PCDC window.
4. Click the appropriate firmware revision and follow prompts to download.
5. Extract the AOP zip file and run Setup.

## Configure the Logix 5000 Controller

These procedures assume that you have wired your Kinetix 5300 drive system. In this example, the GuardLogix® 5580 controller, ControlLogix 1756-ENxT communication module, and CompactLogix 5580 controller dialog boxes are shown.

Follow these steps to configure the controller.

1. Apply power to your controller and open your Logix Designer application.



2. From the Create menu, choose New Project.

---

**IMPORTANT** If you are configuring a safety application, you must use a GuardLogix or Compact GuardLogix safety controller.

---

The New Project dialog box appears.

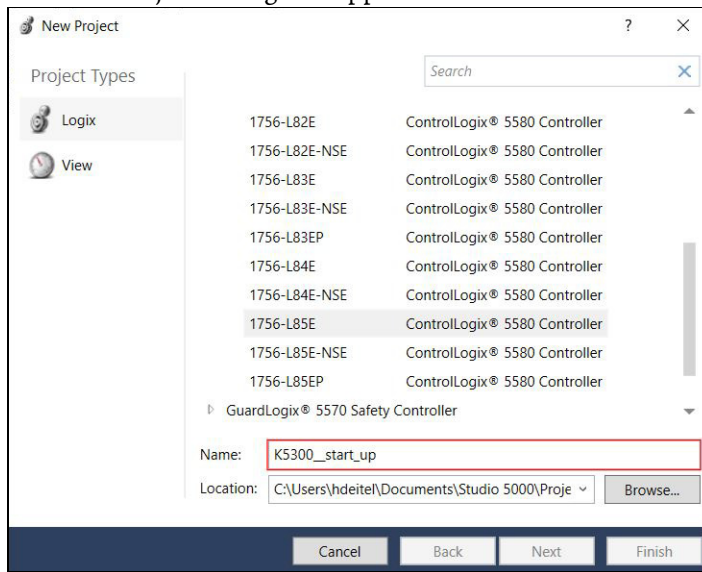

In this example, the typical dialog boxes for 1756-ENxT EtherNet/IP communication modules and ControlLogix 5580 controllers with embedded Ethernet are shown.

Follow these steps to configure your Logix 5000 controller.

1. Expand the Logix 5000 controller family and select your controller.
2. Type the file Name.
3. Click Next.

The New Project dialog box appears.

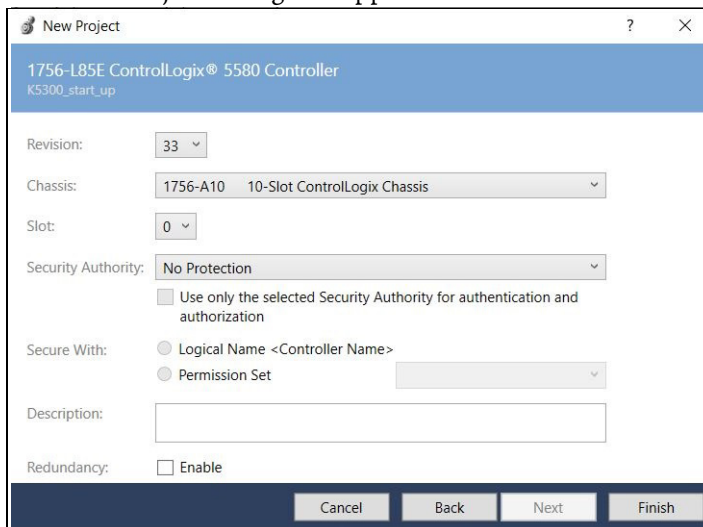

4. From the Revision pull-down menu, choose your software revision.

**IMPORTANT** To configure the Kinetix 5300 drive systems, you must use Studio 5000 Logix Designer, version 33.00 or later.

5. Click Finish.

The new controller appears in the Controller Organizer under the I/O Configuration folder.

Controller Organizer with ControlLogix 5580 controller.



## 6. Configure the Logix 5000 controller.

Your new Logix 5000 controller appears under the I/O Configuration folder in the Controller Organizer. In this example, a ControlLogix 5580 controller with communication module is used.

## 7. Select your controller. Then, from the Edit menu, choose Controller Properties.

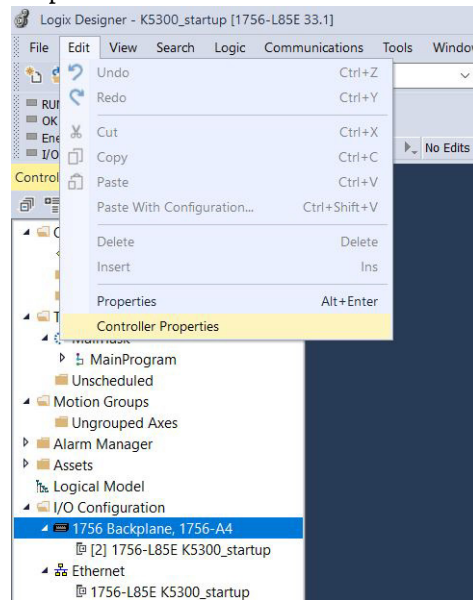

The Controller Properties dialog box appears.

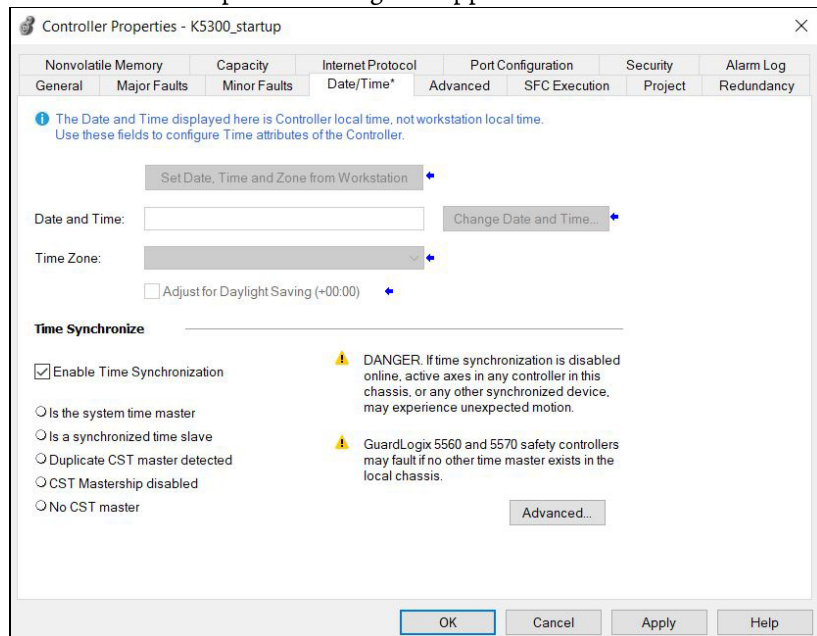

## 8. Click the Date/Time tab.

## 9. Check Enable Time Synchronization.

The motion modules set their clocks to the module that you assign as the Grandmaster.

**IMPORTANT** Check Enable Time Synchronization for all controllers that participate in the CIP Sync™ network. The overall CIP Sync network automatically promotes a Grandmaster clock, unless the priority is set in the Advanced settings.

## 10. Click OK.

## Configure the Kinetix 5300 Drive Modules

**IMPORTANT** To configure 2198-Cxxxx-ERS drives, you must be using Studio 5000 Logix Designer, version 33.00 or later.

### Configure Drive Connections

Follow these steps to configure Kinetix 5300 drives.

1. Below the controller you created, right-click Ethernet and choose New Module.

The Select Module Type dialog box appears.

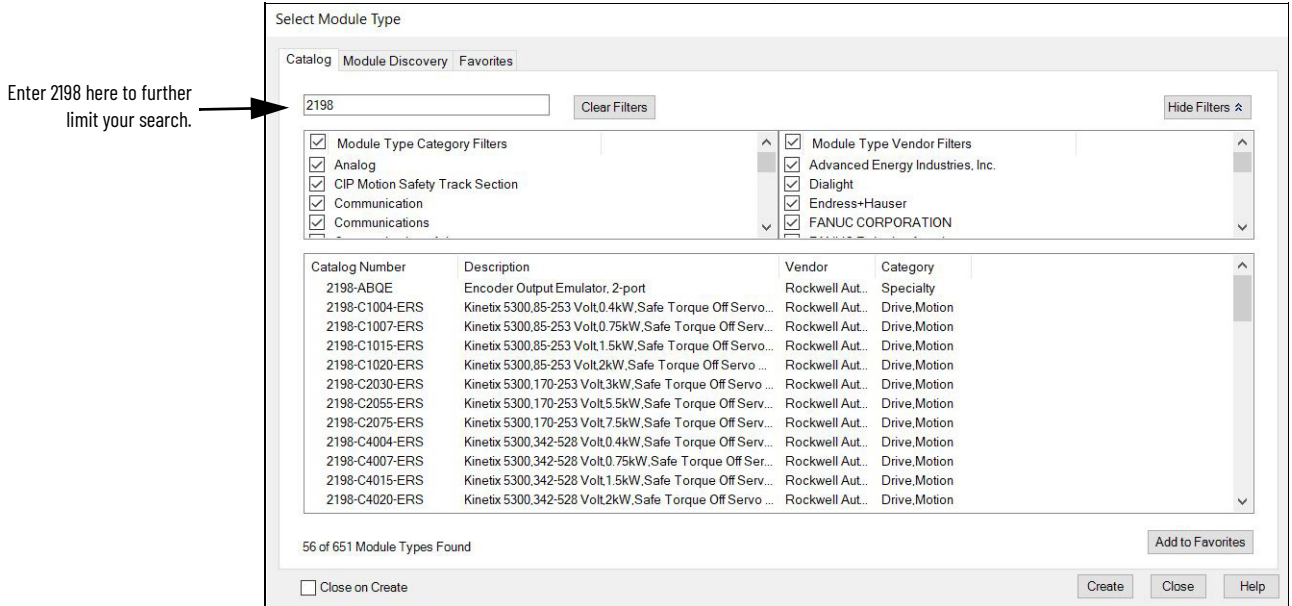

2. In the search bar, enter 2198, and select your 2198-Cxxxx-ERS servo drive as appropriate for your actual hardware configuration.
3. Click Create.

The New Module dialog box appears.

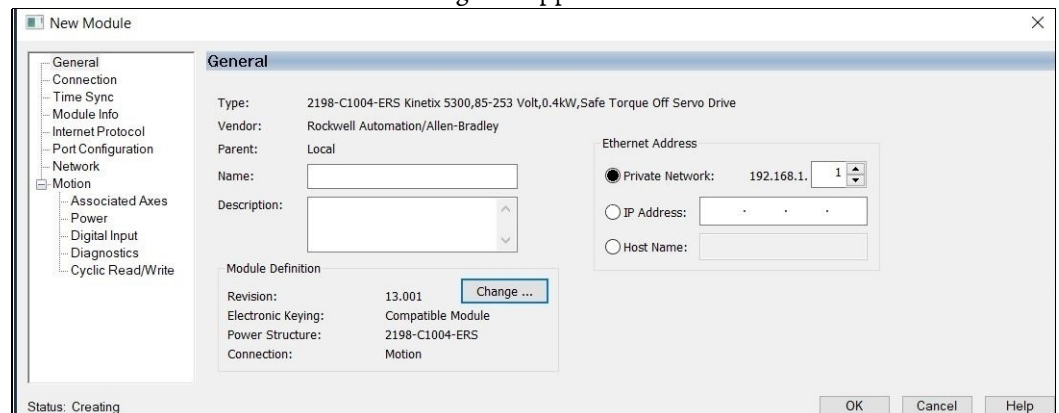

4. Configure the new drive.
  - a. Type the drive Name.
  - b. Select an Ethernet Address option.  
In this example, the Private Network address is selected.
  - c. Enter the address of your 2198-Cxxx-ERS drive.  
In this example, the last octet of the address is 1.

d. Under Module Definition click Change.

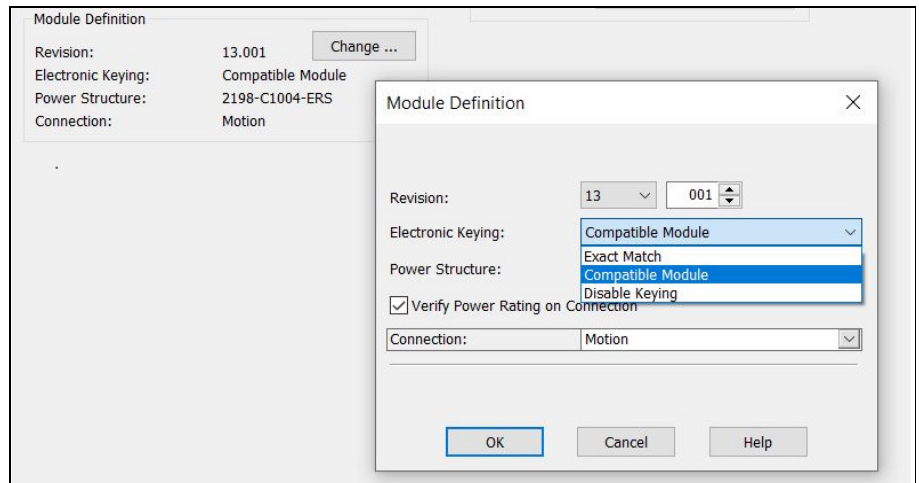

Depending on the Module Definition revision selection, alternate product features can be selected.

**IMPORTANT** Changes within the Module Definition dialog box can cause the module data types and properties to change. Data is set to default values unless it can be recovered from the existing module properties. Verify module properties before applying changes.

5. Close the New Module dialog box by clicking OK.

Your 2198-Cxxxx-ERS servo drive appears in the Controller Organizer under the Ethernet controller in the I/O Configuration folder.

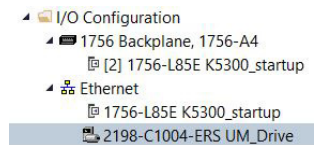

6. Click Close to close the Select Module Type dialog box.

## Continue Drive Configuration

After you've established your Kinetix 5300 drive in the Studio 5000 Logix Designer application, the remaining configuration steps are the same regardless of the drive catalog number.

For the Kinetix 5300, two axes are supported.

- Axis 1 applies to the Motor Feedback connector (MFB)
- Axis 2 applies to the Digital Inputs and Auxiliary Feedback connector.

See [Table 26 on page 60](#) for the location of the connectors and refer to [Understand Control Signal Specifications on page 56](#) for additional information about the connector functions.

Follow these steps to configure the associated axes.

1. Right-click the 2198-Cxxxx-ERS servo drive that you created and choose Properties.
2. Click Associated Axes.

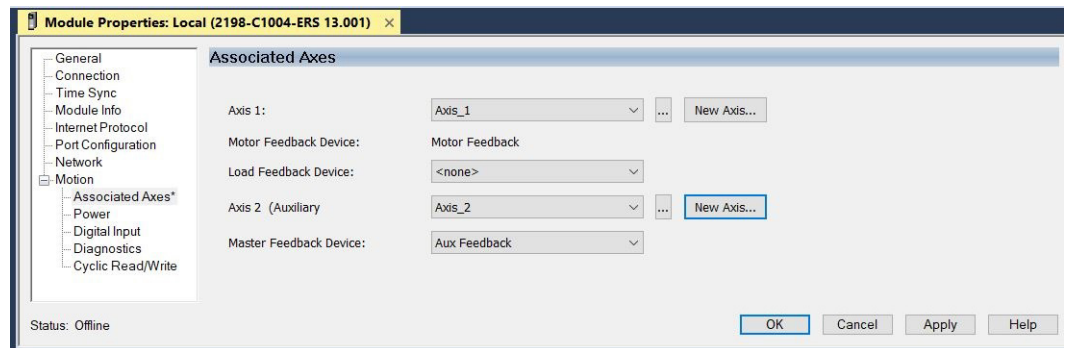

3. Click New Axis.

The New Tag dialog box appears.

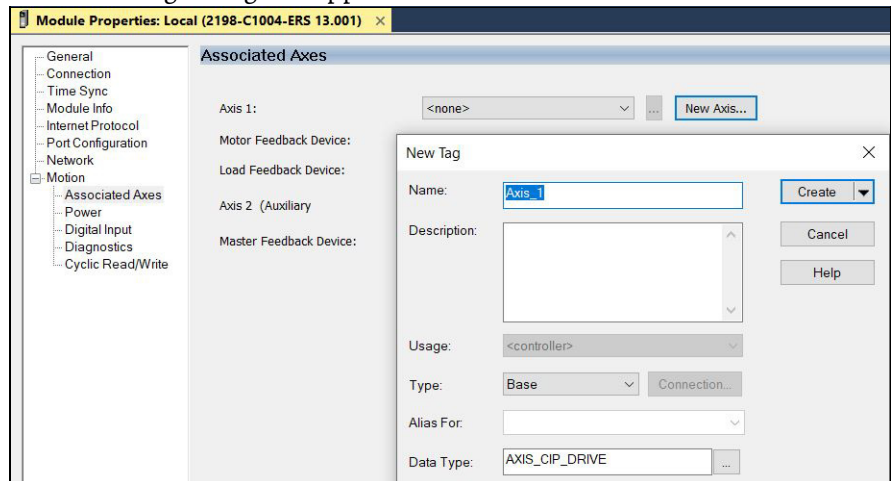



## 4. Type the axis Name.

AXIS\_CIP\_DRIVE is the default Data Type. The feedback devices can be configured for Motor Feedback or Auxiliary Feedback. See [Table 62](#) for feedback types.

**Table 62 - Feedback Options**

Feedback Options	Description
Motor Feedback <sup>(1)</sup>	15-pin connector that applies to Hiperface multi-turn and single-turn absolute, Nikon (24-bit) high-resolution serial, and Tamagawa (17-bit) high-resolution serial encoders. Also, digital AqB encoders with UVW, and generic sin/cos incremental encoders with UVW.
Auxiliary Feedback	20-pin connector that applies to TTL incremental encoders for load feedback (dual loop), master feedback, or feedback-only via flying leads.

(1) The 2198-K53CK-D15M feedback connector kit with 15-pin connector plug and battery backup is available for flying-lead cables.

- From the Axis pull-down menu, choose an axis to assign to the motor or auxiliary feedback device.
- Click Create.

The axis (Axis\_1 in this example) appears in the Controller Organizer under Motion Groups> Ungrouped Axes and is assigned as Axis 1.

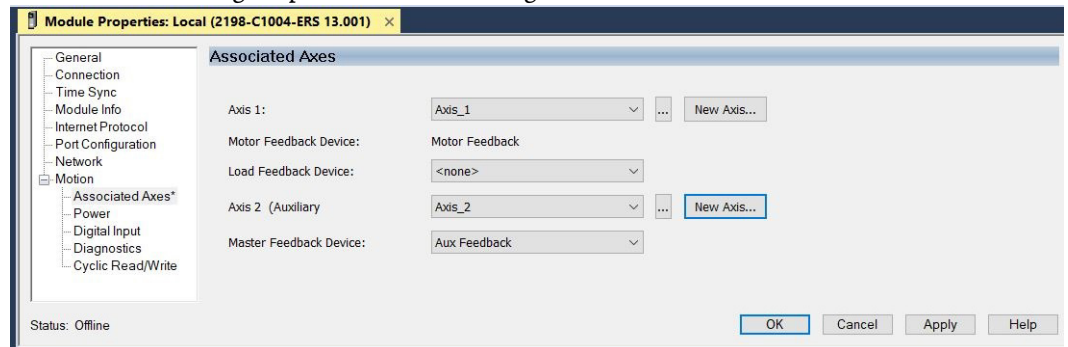
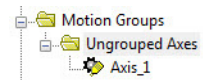

You can configure an axis as Feedback Only. See [Configure Feedback-only Axis Properties](#) on [page 116](#) for more information. See [Configure Module Properties](#) for configuring motor feedback, load feedback, and master feedback devices

- Click Apply.
- Select the Digital Input category.

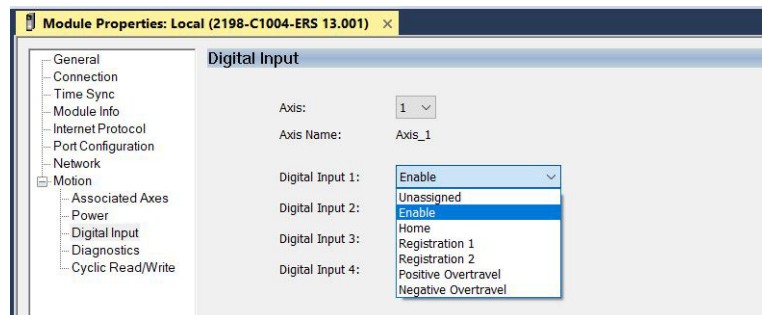

- From the Digital Input pull-down menus, choose a digital input assignment appropriate for your application.

For more information on the configurable functions and digital input specifications, see [Table 16 on page 54](#) and [Digital Inputs on page 56](#).

- Click Apply.

11. Select the Power category.

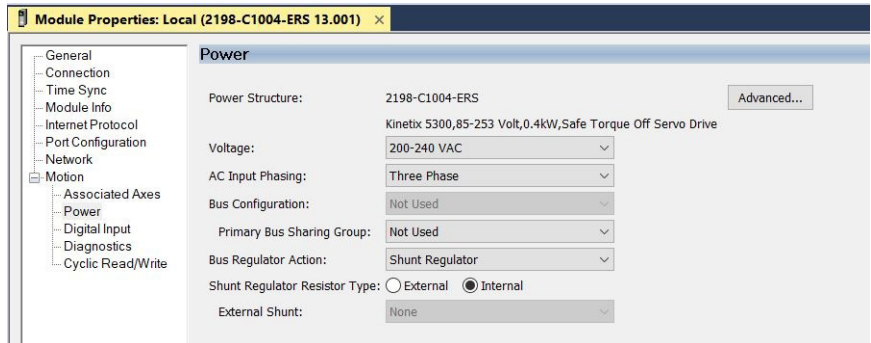

12. From the pull-down menus, choose the power options appropriate for your actual hardware configuration.



**ATTENTION:** To avoid damage to equipment, make sure that the AC input voltage that is configured in the Logix Designer application matches the actual hardware being configured.

Attribute	Menu	Description
Voltage <sup>(1)</sup>	400-480V AC	342...528V AC rms input voltage
	200-240V AC	170...253V AC rms input voltage
	110-120V AC	85...132V AC rms input voltage
AC Input Phasing	<ul style="list-style-type: none"> <li>Three Phase</li> <li>Single Phase</li> </ul>	Input power phasing. Kinetix 5300 drives with single-phase operation are limited to 2198-C1004-ERS, 2198-C1007-ERS, 2198-C1015-ERS, and 2198-C1020-ERS.
Bus Regulator Action	Shunt Regulator	Enables the internal and external shunt options.
Shunt Regulator Resistor Type	Internal	Enables the internal shunt (external shunt option is disabled).
	External	Enables the external shunt (internal shunt option is disabled).
External Shunt <sup>(2)</sup>	<ul style="list-style-type: none"> <li>2198-R004</li> <li>2198-R014</li> <li>2198-R031</li> <li>2097-R6</li> <li>2097-R7</li> </ul>	Selects external shunt option. Only the shunt model that is intended for the drive being configured is shown.

(1) The voltage that is listed is nominal.

(2) See the Kinetix 5700, 5500, 5300, and 5100 Servo Drives Specifications Technical Data, publication [KNX-TD003](#), for more information on the Bulletin 2097 external shunt resistors.

13. Click OK.

14. Repeat [step 1](#) through [step 13](#) for each 2198-Cxxxx-ERS servo drive.

## Configure the Motion Group

Follow these steps to configure the motion group.

1. In the Controller Organizer, right-click Motion Groups and choose New Motion Group.

The New Tag dialog box appears.

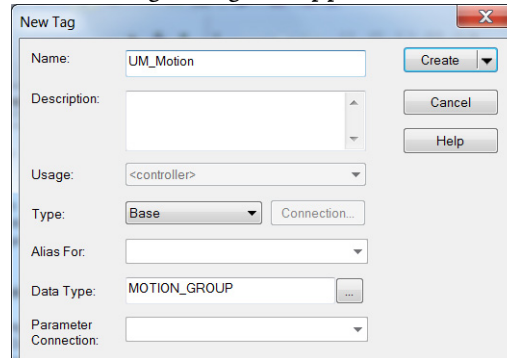

2. Type the new motion group Name.
3. Click Create.

Your new motion group appears in the Controller Organizer under the Motion Groups folder.

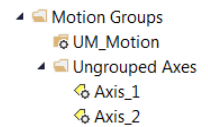

4. Right-click the new motion group and choose Properties.

The Motion Group Properties dialog box appears.

5. Click the Axis Assignment tab and move your axes (created earlier) from Unassigned to Assigned.

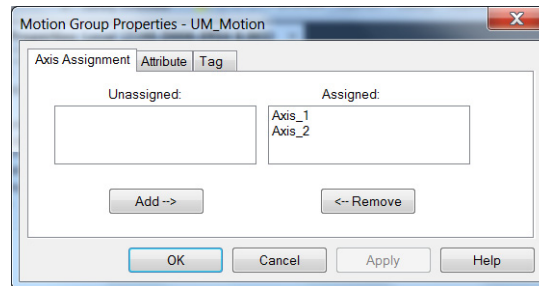

6. Click the Attribute tab and edit the default values as appropriate for your application.
7. Click OK.

Your axes move to the new motion group.

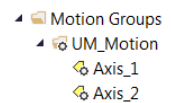

## Configure Vertical Load Control Axis Properties

A vertical load is an axis that can move due to stored potential energy. Some examples include a robot arm, lift, or compressed spring. When set to Enabled, rather than applying Stop Category 0 stopping actions in response to most major fault conditions, the drive brings the motor to a controlled stop and engages the holding brake before disabling the power structure.

When Vertical Load Control is enabled and the drive supports Torque Proving and Brake Proving functionality, the controller sets the associated Proving Configuration attribute default value to enable.

**IMPORTANT** Brake proving functionality is applicable only to drive control modes that are capable of generating holding torque based on a feedback device. Therefore, Brake Proving is not applicable to Frequency Control mode with the Sensorless Vector control method.

For more information on controlling vertical loads, see the Vertical Load and Holding Brake Management Application Technique, publication [MOTION-AT003](#).

Figure 58 - Configure Vertical Load Control

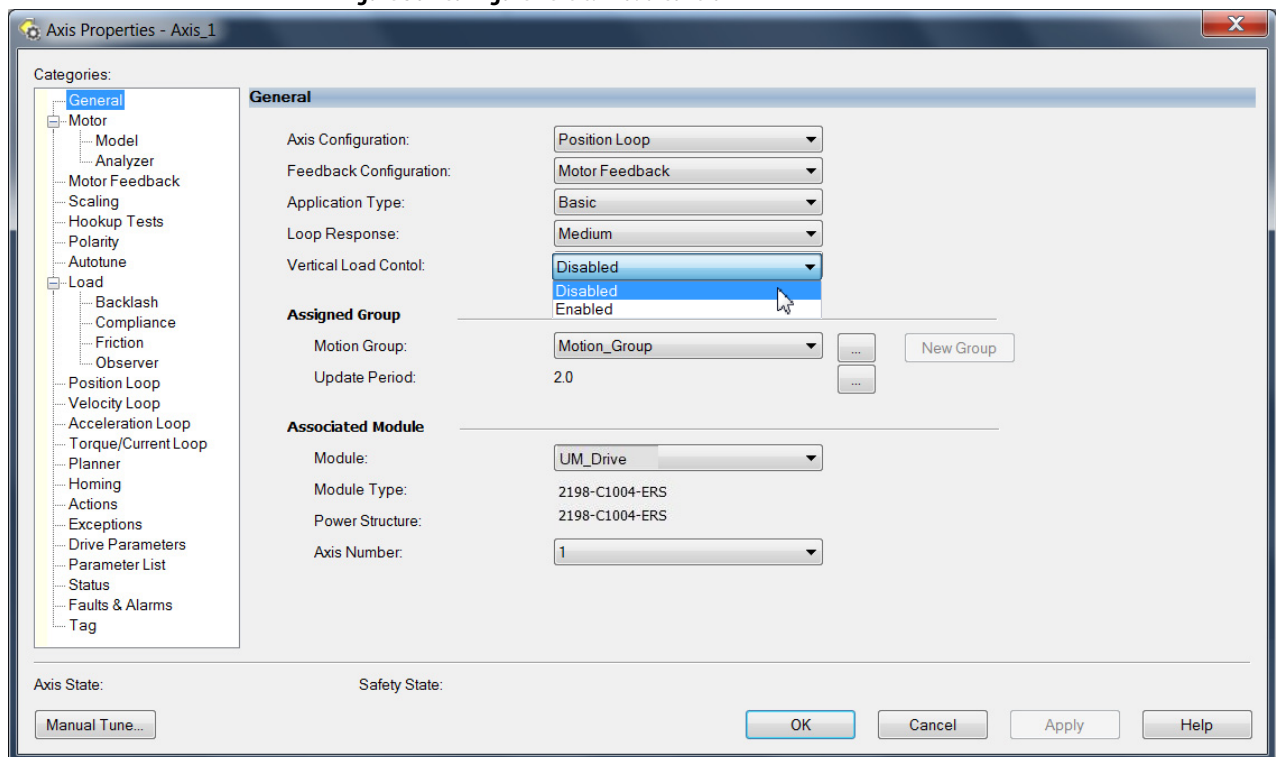

## Configure Feedback-only Axis Properties

Follow these steps to configure feedback-only axis properties.

1. In the Controller Organizer, right-click an axis and choose Properties.
2. Select the General category.

The General dialog box appears.

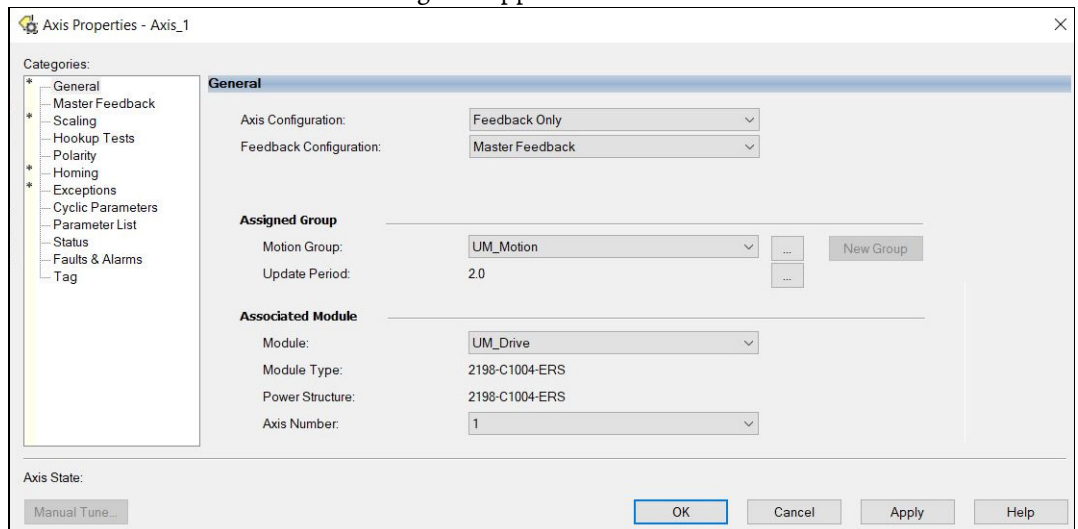

3. From the Axis Configuration pull-down menu, choose Feedback Only.
4. From the Feedback Configuration pull-down menu, choose Master Feedback.
5. From the Module pull-down menu, choose the drive to associate with your Feedback Only axis.

The Module Type and Power Structure fields populate with the chosen drive catalog number.

6. Click Apply.
7. Configure module properties for your Kinetix 5300 servo drive for Master Feedback.

See Configure Module Properties on [page 133](#) for configuration examples.

8. Select the Master Feedback Category.

The Master Feedback Device Specification appears.

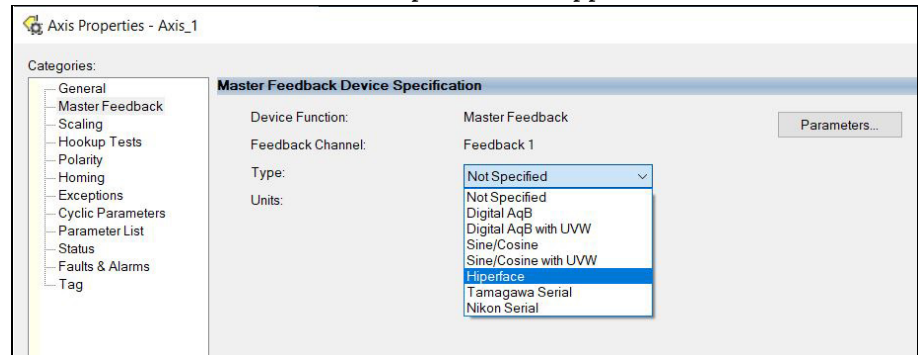

9. From the Type pull-down menu, choose a feedback device type.  
See Configure Axis Properties beginning on [page 134](#) for configuration examples.
10. Review other categories in the Controller Organizer and make changes as needed for your application.
11. Click OK.

For more information on auxiliary feedback signals and Allen-Bradley® auxiliary feedback encoders available for use, see [Auxiliary Feedback Specifications on page 61](#).

## Configure Induction-motor Frequency-control Axis Properties

Follow these steps to configure induction-motor axis properties for various frequency control methods.



See Motor Nameplate Datasheet Entry for Custom Motor Applications, publication [2198-AT002](#) to determine which configuration method is best suited for your application.

### General and Motor Categories

1. In the Controller Organizer, right-click an axis and choose Properties.
2. Select the General category.

The General dialog box appears.

3. From the Axis Configuration pull-down menu, choose Frequency Control.
4. From the Feedback Configuration pull-down menu, choose No Feedback.
5. From the Module pull-down menu, choose the drive to associate with your Frequency Control (induction motor) axis.

The Module Type and Power Structure fields populate with the chosen drive catalog number.

6. Click Apply.
7. Select the Motor category.

8. From the Data Source pull-down menu, choose Nameplate Datasheet. Nameplate Datasheet is the default setting.

9. From the Motor Type pull-down menu, choose Rotary Induction.
10. From the motor nameplate or datasheet, enter the phase-to-phase values for your motor.

For a motor nameplate/datasheet example, see [Motor Category on page 212](#). Also, see Motor Nameplate Datasheet Entry for Custom Motor Applications, publication [2198-AT002](#).

11. Click Apply.

## Basic Volts/Hertz Method

1. Configure the General category and Motor category as shown in [General and Motor Categories](#) on [page 118](#).
2. Select the Frequency Control category.
3. From the Frequency Control Method pull-down menu, select Basic Volts/Hertz.

Axis Properties - Axis\_1

Categories:

- General
- Motor
  - Model
  - Analyzer
  - Scaling
  - Hookup Tests
  - Polarity
  - Load
  - Planner
  - Frequency Control
  - Actions
  - Exceptions
  - Cyclic Parameters
  - Parameter List
  - Status
  - Faults & Alarms
  - Tag

**Frequency Control**

Frequency Control Method: Basic Volts/Hertz Parameters...

Maximum Voltage: 0.0 Volts (RMS)

Maximum Frequency: 130.0 Hertz

Break Voltage: 230.0 Volts (RMS)

Break Frequency: 30.0 Hertz

Start Boost: 8.5 Volts (RMS)

Run Boost: 8.5 Volts (RMS)

**Limits**

Velocity Limit Positive: +100.0 Position Units/s

Velocity Limit Negative: -100.0 Position Units/s

Axis State:

Manual Tune... OK Cancel Apply Help

4. Enter the Basic Volts/Hertz attribute values appropriate for your application.  
Default values are shown.
5. Click Apply.

Axis Properties - Axis\_1

Categories:

- General
- Motor
  - Model
  - Analyzer
  - Scaling
  - Hookup Tests
  - Polarity
  - Load
  - Planner
  - Frequency Control
  - Actions
  - Exceptions
  - Cyclic Parameters
  - Parameter List
  - Status
  - Faults & Alarms
  - Tag

**Motion Axis Parameters**

Parameter Group: Frequency Control Associated Page...

Name	Value	Unit
BreakFrequency	30.0	Hertz
BreakVoltage	230.0	Volts (RMS)
CurrentVectorLimit	0.0	% Motor Rated
FluxUpControl	Automatic Delay	
FluxUpTime	0.0	s
FrequencyControlMethod	Basic Volts/Hertz	
MaximumFrequency	130.0	Hertz
MaximumVoltage	0.0	Volts (RMS)
RunBoost	8.5	Volts (RMS)
SkipSpeed1	0.0	Position Units/s
SkipSpeed2	0.0	Position Units/s
SkipSpeedBand	0.0	Position Units/s
StartBoost	8.5	Volts (RMS)
VelocityDroop	0.0	(Position Units/s)/% Rated
VelocityLimitNegative	0.0	Position Units/s
VelocityLimitPositive	0.0	Position Units/s
VelocityLockTolerance	0.0	Position Units/s

6. Click OK.

## Sensorless Vector Method

1. Configure the General category and Motor category as shown in [General and Motor Categories](#) on [page 118](#).

2. Select the Frequency Control category.
3. From the Frequency Control Method pull-down menu, choose Sensorless Vector.

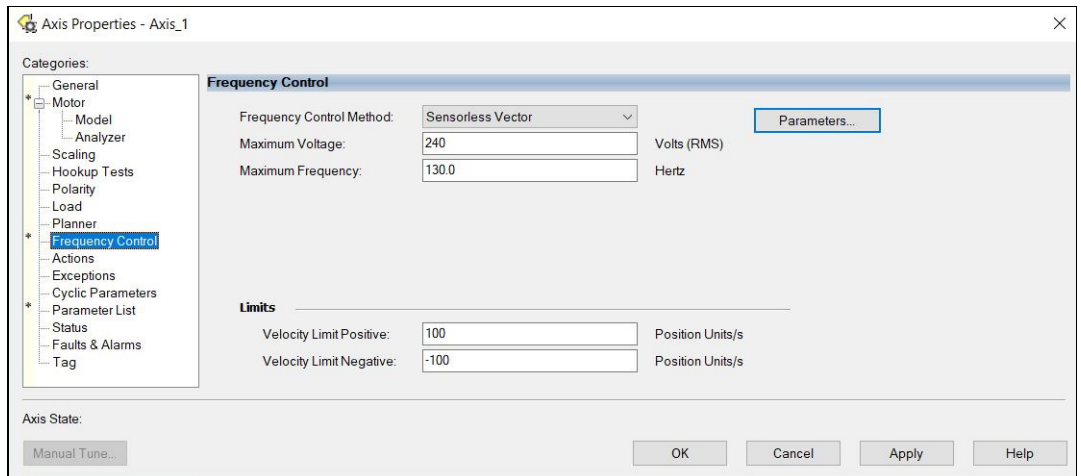

4. Enter the Sensorless Vector attribute values appropriate for your application. Default values are shown.
5. Click Apply.

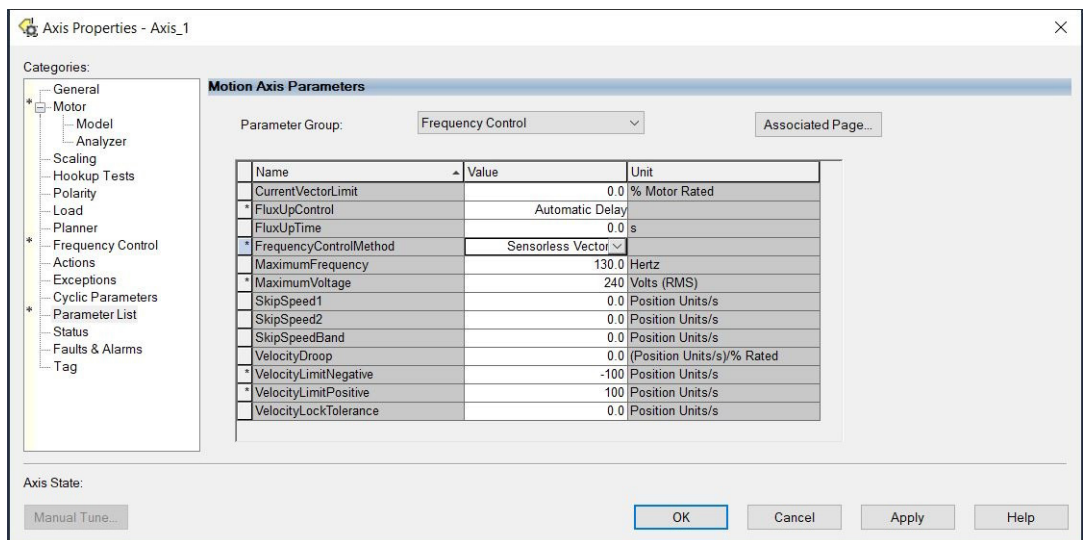

6. Select the Motor > Model category. Motor model attributes are automatically estimated from the Nameplate/Datasheet parameters. For improved performance, motor tests can be run.
7. Select the Motor > Analyzer category.
8. The Analyze Motor to Determine Motor Model dialog box opens.



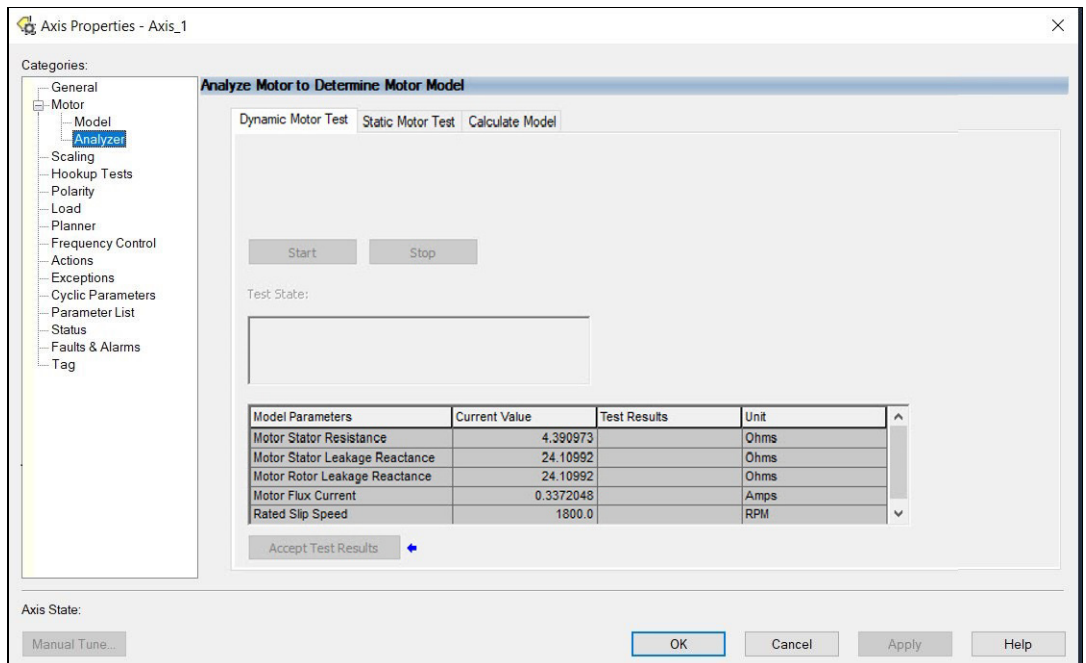

- Click one of the motor test tabs.

In this example, the Calculate Model is chosen. See [Test and Tune the Axes on page 138](#) for information about each of the tests.

- Click Start.
- Click Accept Test Results.
- Click OK.

## Fan/Pump Volts/Hertz Method

- Configure the General category and Motor category as shown in [General and Motor Categories on page 118](#).
- Select the Frequency Control category.
- From the Frequency Control Method pull-down menu, select Fan/Pump Volts/Hertz.

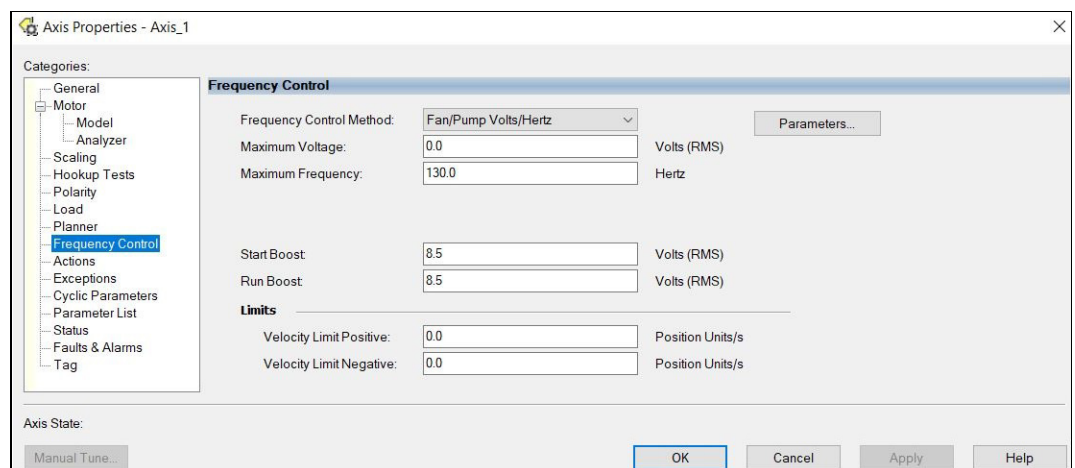

- Enter the Fan/Pump Volt/Hertz attribute values appropriate for your application.  
Default values are shown.
- Click Apply.

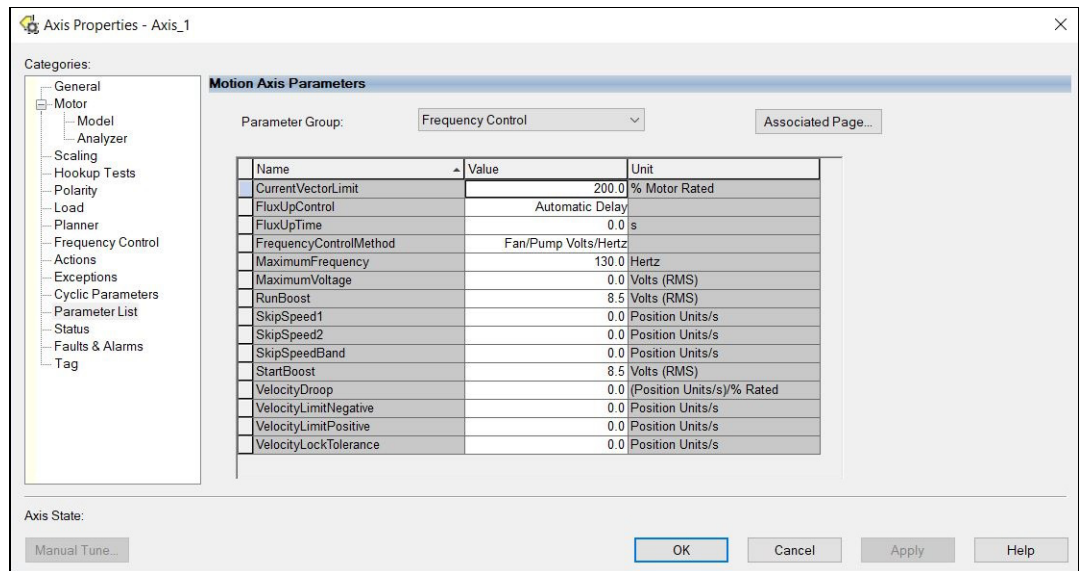

6. Click OK.

## Configure SPM Motor Closed-loop Control Axis Properties

Follow these steps to configure surface permanent-magnet (SPM) motor closed-loop axis properties.

Table 63 - Motor Feedback Device Options

Motor Feedback Device Option	Feedback Type		Description	Feedback Connector
Motor Feedback	Hiperface	High-resolution single-turn and multi-turn, absolute	Applies to Kinetix MPL, MPM, MPF, MPS (-M/S or -V/E); Kinetix MPAS (ballscrew), MPAI, linear actuators; and Kinetix LDAT (-xDx) linear thrusters.	15-pin Motor Feedback (MFB)
	Nikon		Applies to Kinetix TLP motors.	
	Tamagawa		Applies to Kinetix TL (-B) and TLY motors.	
	Digital AqB	Incremental	Applies to Kinetix MPL (-H) rotary motors, Kinetix MPAS (direct-drive) linear actuators, Kinetix LDAT (-xBx) linear thrusters, Kinetix TLY (-H) servo motors, and Kinetix LDL/Kinetix LDC linear motors.	
	Digital AqB with UVW			
	Sine/Cosine			
Auxiliary Feedback and Digital Input <sup>(1)</sup>	Digital AqB	Incremental	Applies to Digital AqB encoders.	20-pin Auxiliary Feedback Connector

(1) The auxiliary feedback connectors allow configuration of a Digital AqB encoder as a load feedback device or a half-axis (feedback only).

**IMPORTANT** Unprogrammed Smart feedback devices are not supported. Unprogrammed as load or feedback-only feedback types are supported. Contact your local distributor or Rockwell Automation representative for support options.

1. In the Controller Organizer, right-click an axis and choose Properties.
2. Select the General category.

The General and Associated Module dialog box appears.

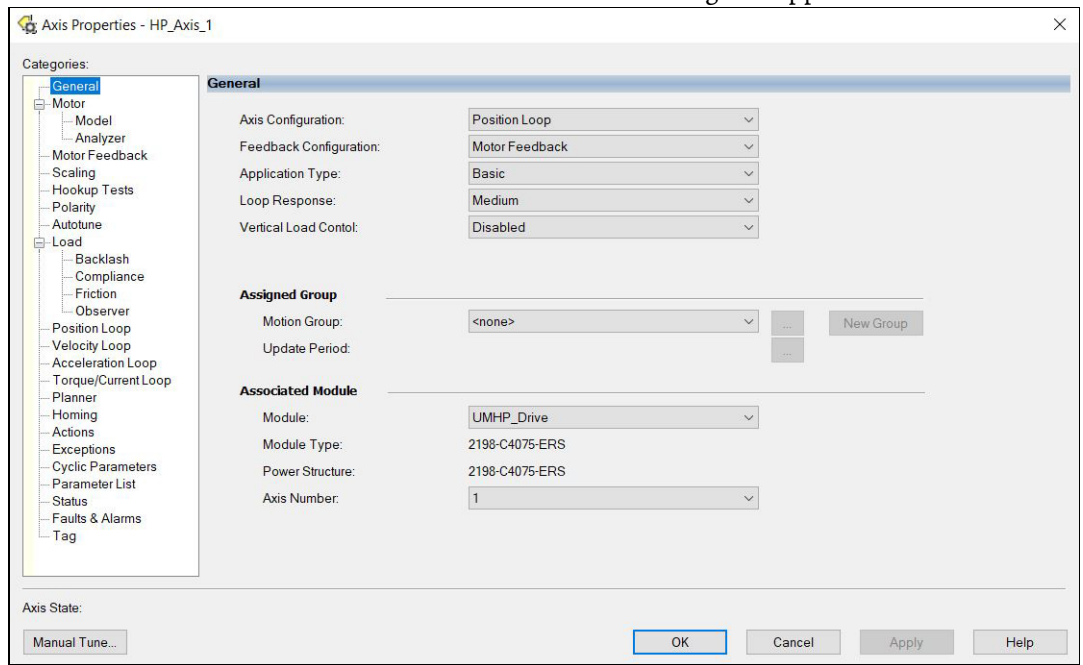

- From the General pull-down menus, change configuration settings as needed for your application.

**IMPORTANT** Frequency Control is not supported for permanent magnet motors.

- From the Associated Module > Module pull-down menu, choose your Kinetix 5300 drive.  
The drive catalog number populates the Module Type and Power Structure fields.
- Click Apply.
- Select the Motor category.

The Motor Device Specification dialog box appears.

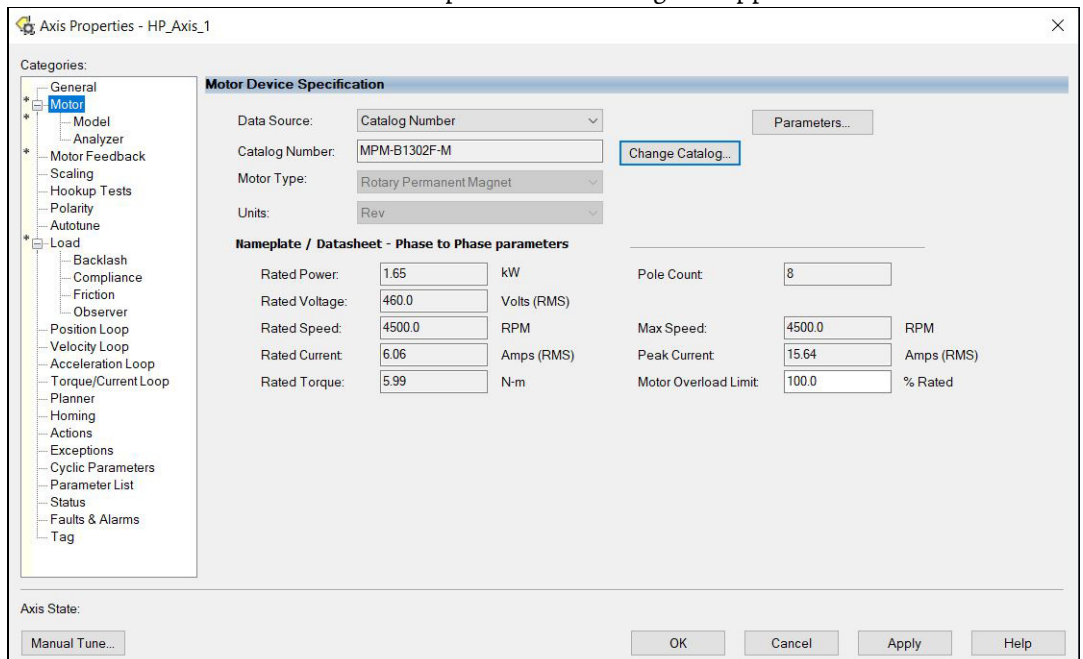

- From the Data Source pull-down menu, choose Catalog Number.
- Click Change Catalog.

The Change Catalog Number dialog box appears.

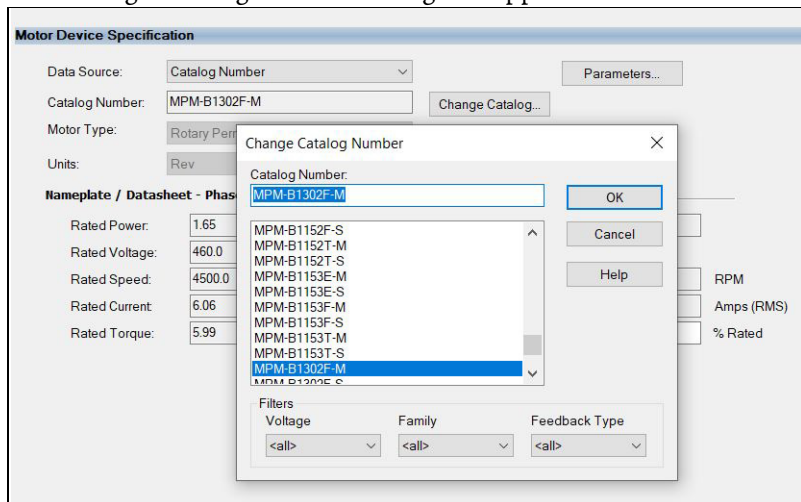

9. Select the motor catalog number appropriate for your application. To verify the motor catalog number, see the motor nameplate.

**IMPORTANT** To configure Allen-Bradley motors and actuators with your Kinetix 5300 servo drive, you must have drive firmware revision 13 or later, and Studio 5000 Logix Designer application version 33 or later.

10. Close the Change Catalog Number dialog box by clicking OK.
11. Click Apply. Motor data specific to your motor appears in the Nameplate / Datasheet - Phase to Phase parameters field.
12. Select the Scaling category and edit the default values as appropriate for your application.

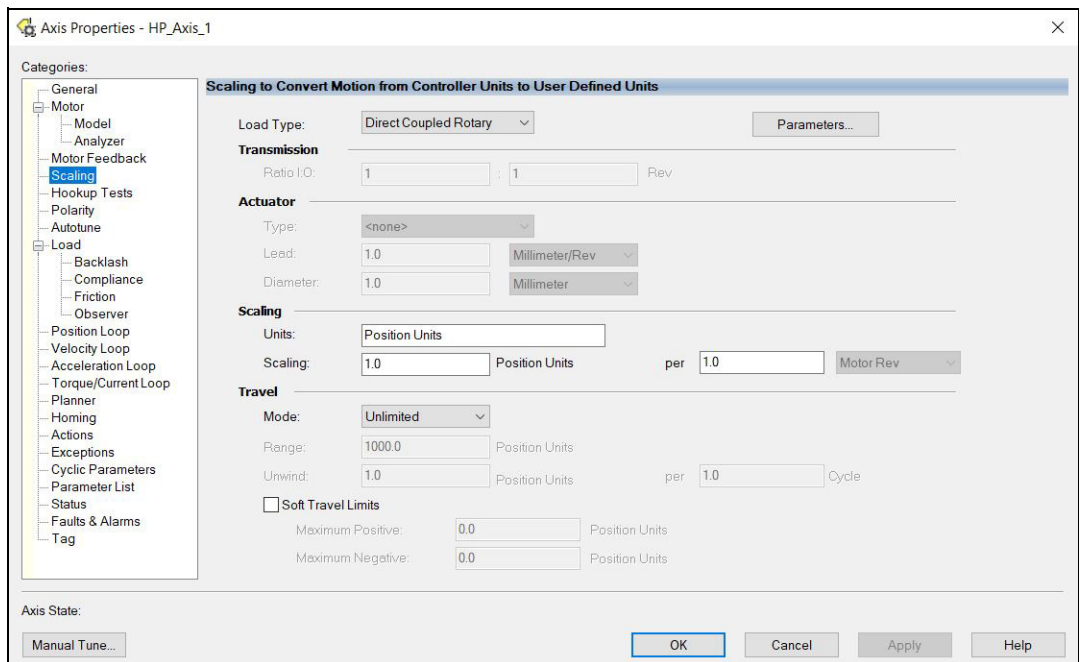

13. Click Apply, if you make changes.

14. Select the Load category and edit the default values as appropriate for your application.

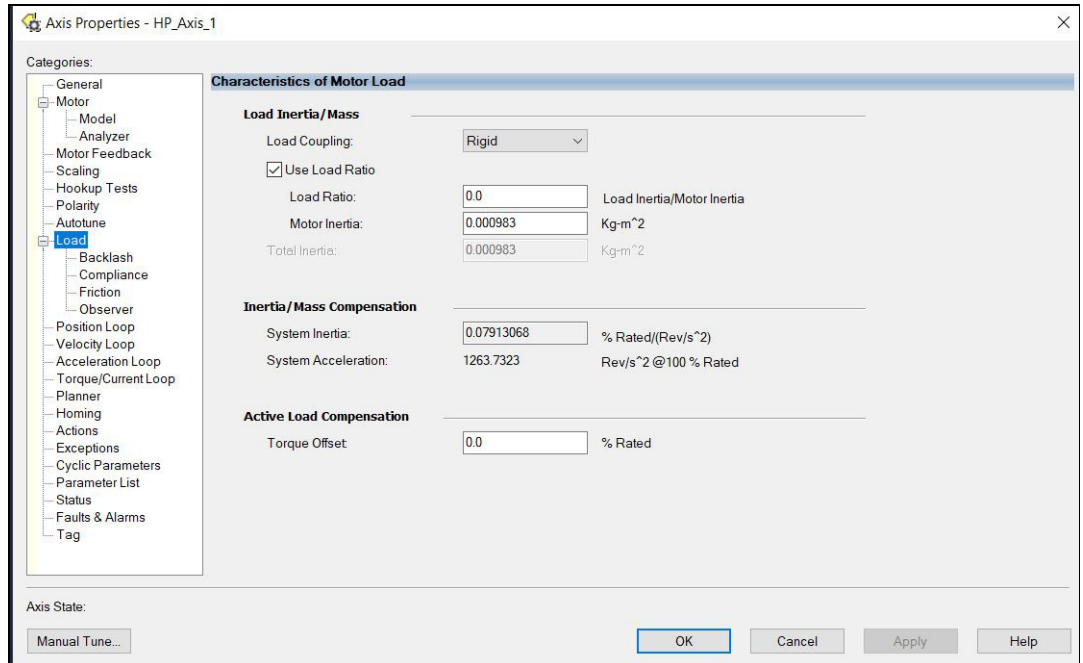

15. Click Apply, if you make changes.  
16. Select the Actions category.

The Actions to Take Upon Conditions dialog box appears.

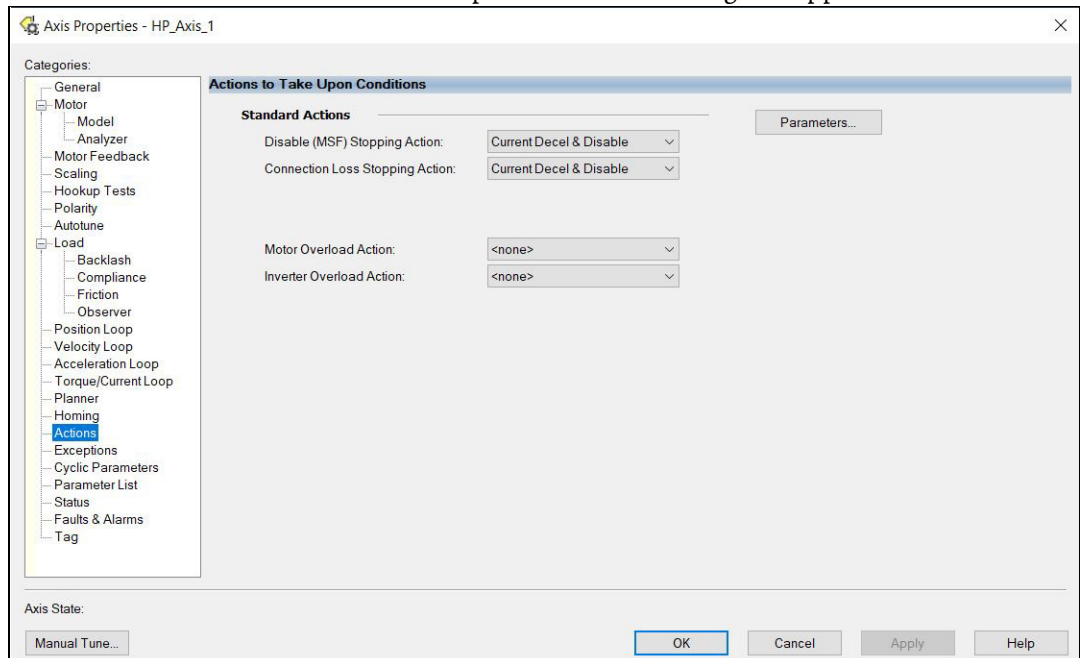

From this dialog box, you can program actions for the drive module to take. For more information, see [Logix 5000 Controller and Drive Behavior on page 145](#).

17. Select the Exceptions category.

The Action to Take Upon Exception Condition dialog box appears.

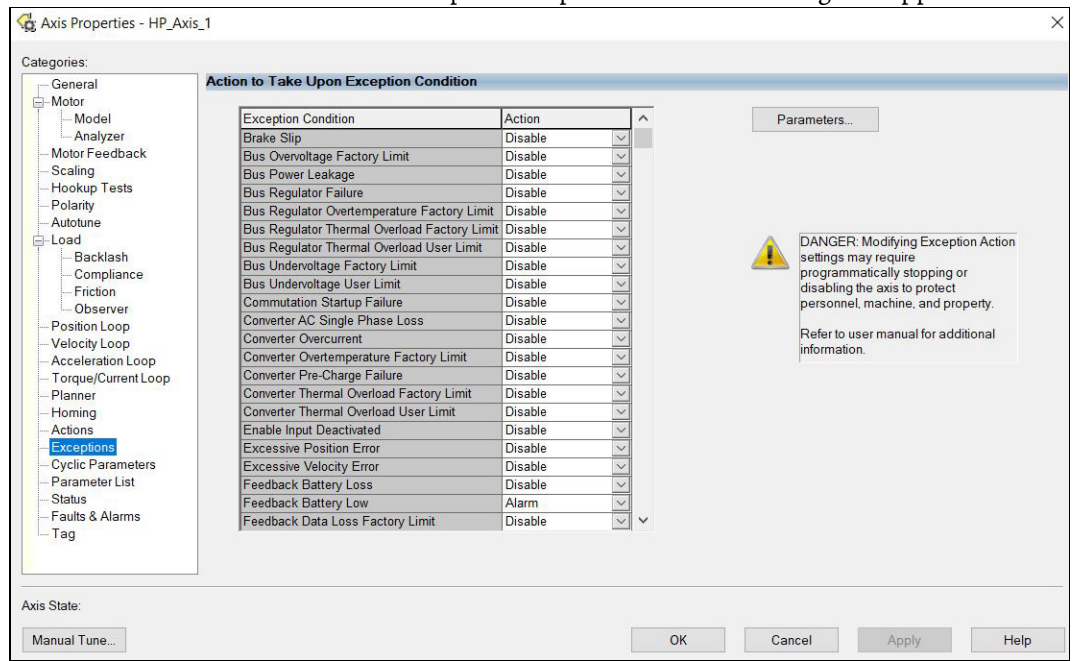

From this dialog box, you can change the action for exceptions (faults). For more information, see [Logix 5000 Controller and Drive Behavior on page 145](#).



In the Logix Designer application, version 32.00 and later, Disable replaced Stop Drive as the default Action.

18. Select the Parameter List category.

The Motion Axis Parameters dialog box appears. Use the Parameter Group pull-down menu, and choose the appropriate group. By default, all parameters are shown in the dialog box.

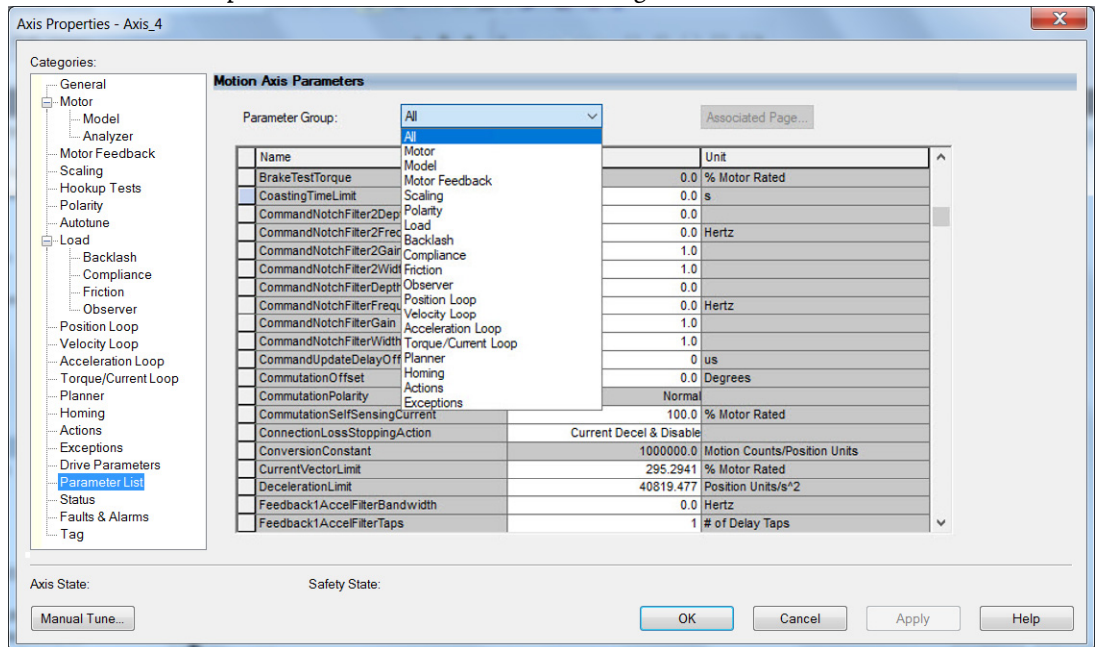

From this dialog box, along with other parameters, you can set brake engage and release delay times for servo motors.

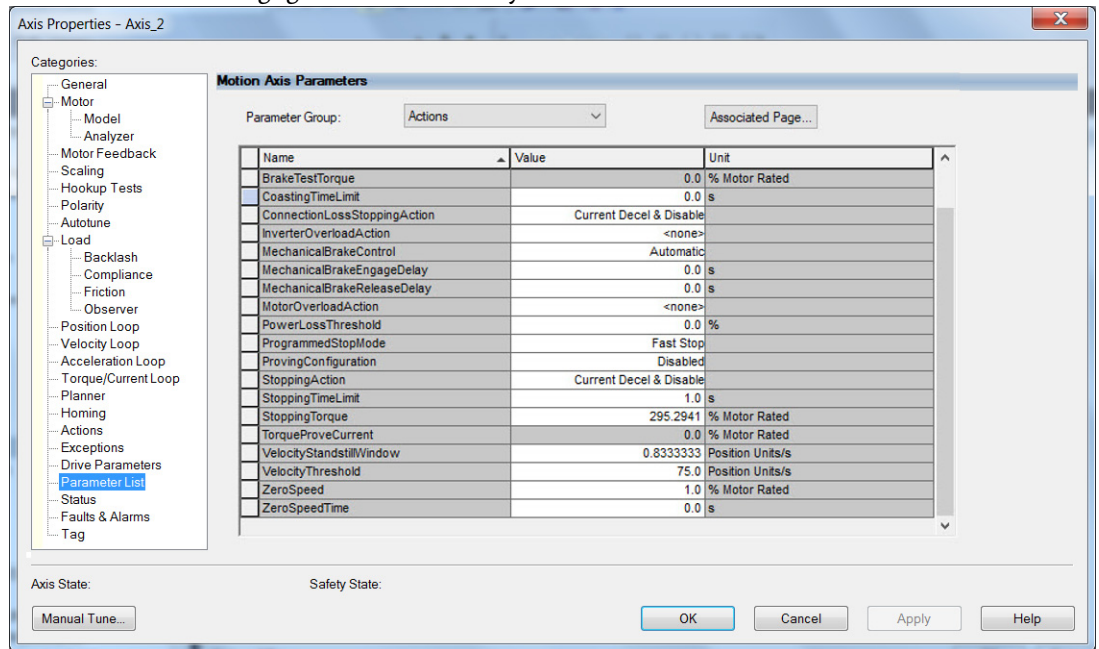

For recommended motor brake delay times, refer to the Kinetix Rotary Motion Specifications Technical Data, publication [KNX-TD001](#).

19. Click OK.
20. Repeat [step 1](#) through [step 19](#) for each servo motor axis.

## Configure Induction-motor Closed-loop Control Axis Properties

Follow these steps to configure induction-motor closed-loop control axis properties.

1. In the Controller Organizer, right-click an axis and choose Properties.
2. Select the General category.

The General and Associated Module dialog box appears.

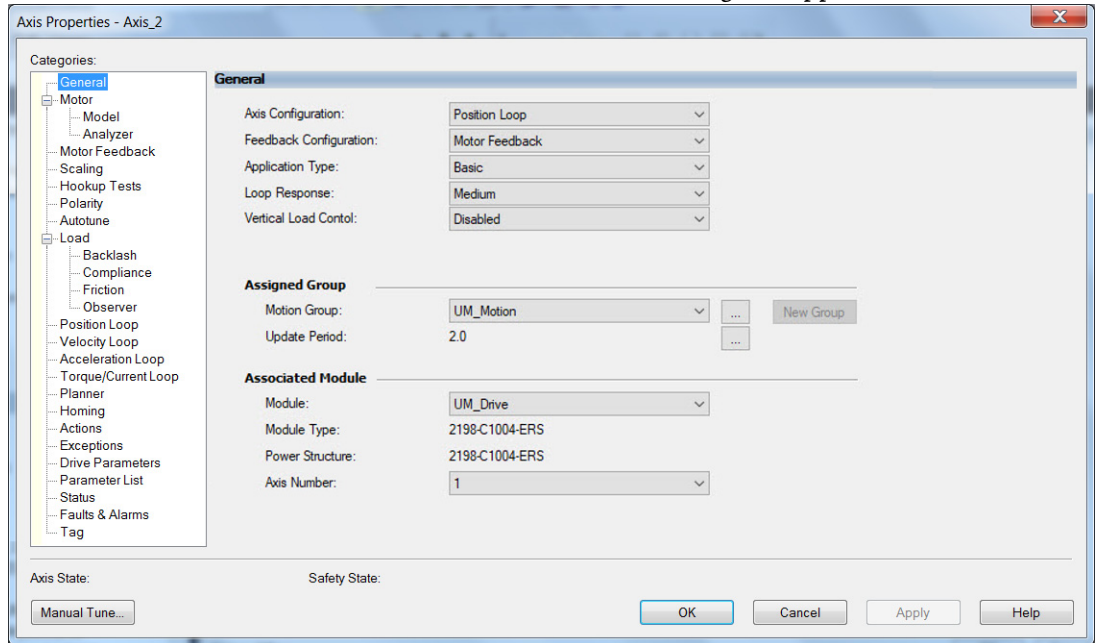

3. From the General pull-down menus, change configuration settings as needed for your application.
4. From the Associated Module > Module pull-down menu, choose your Kinetix 5300 drive.

The drive catalog number populates the Module Type and Power Structure fields.

5. Click Apply.
6. Select the Motor category.

The Motor Device Specification dialog box appears.

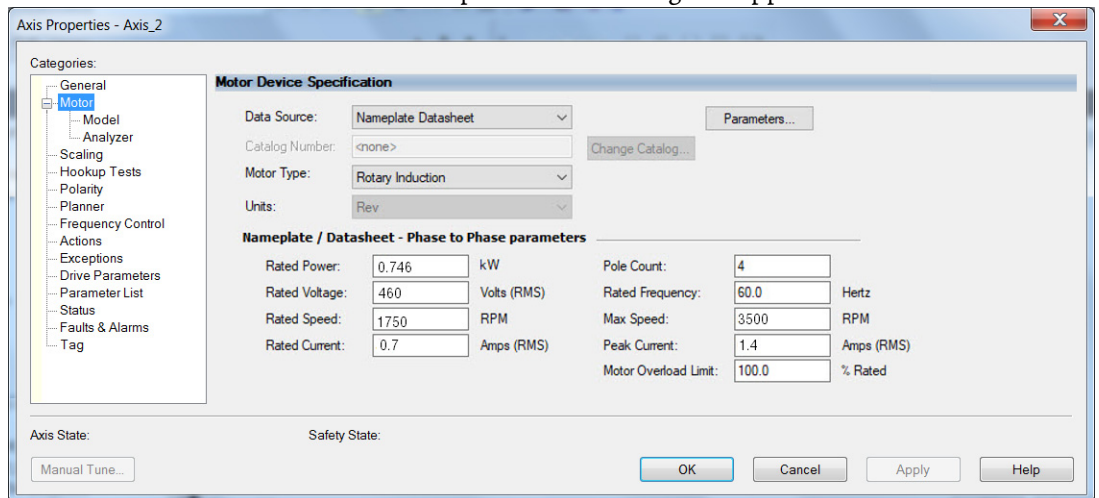

7. From the Data Source pull-down menu, choose Nameplate Datasheet.

**IMPORTANT** Motor NV is not a supported data source in the Logix Designer application for axes that are configured as Induction-motor closed-loop.



8. Click Apply and return to the Motor category.
9. From the Motor Type pull-down menu, choose Rotary Induction.
10. From the motor nameplate or datasheet, enter the phase-to-phase values for your motor.

For a motor performance datasheet example, see [Motor Category on page 212](#). Also see Motor Nameplate Datasheet Entry for Custom Motor Applications, publication [2198-AT002](#).

11. Click Apply.
12. Select the Motor Feedback category.

The Motor Feedback Device Specification dialog box appears.

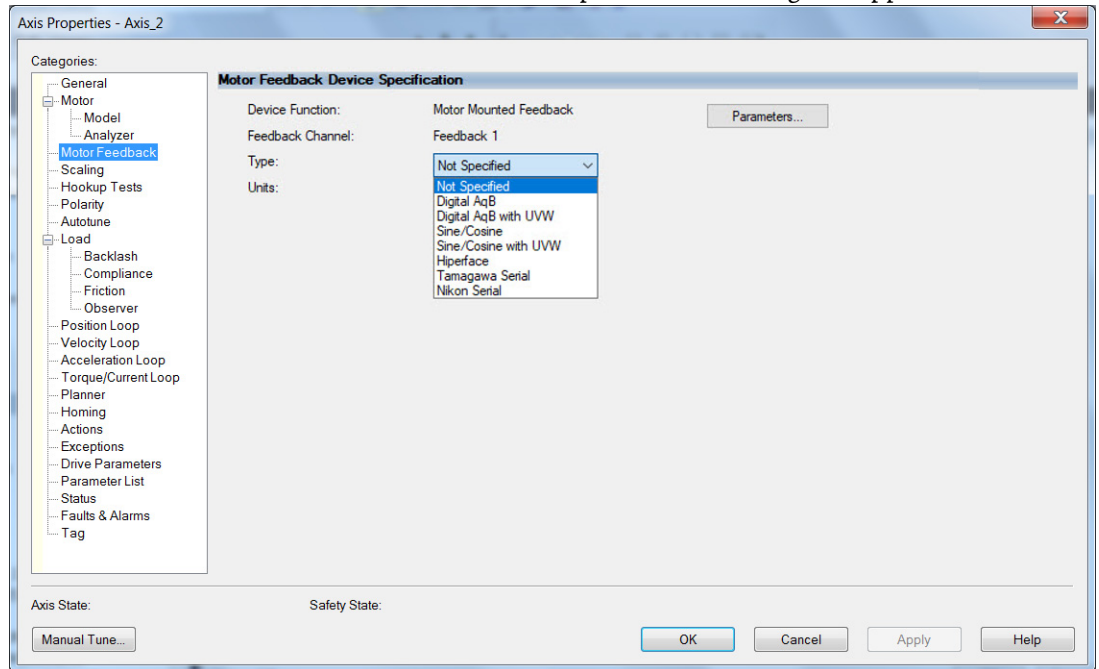

13. From the Type pull-down menu, choose the feedback type appropriate for your application.  
See [Configure Feedback Properties on page 133](#) for feedback configuration examples.
14. Click Apply.

15. Select the Scaling category and edit the default values as appropriate for your application.

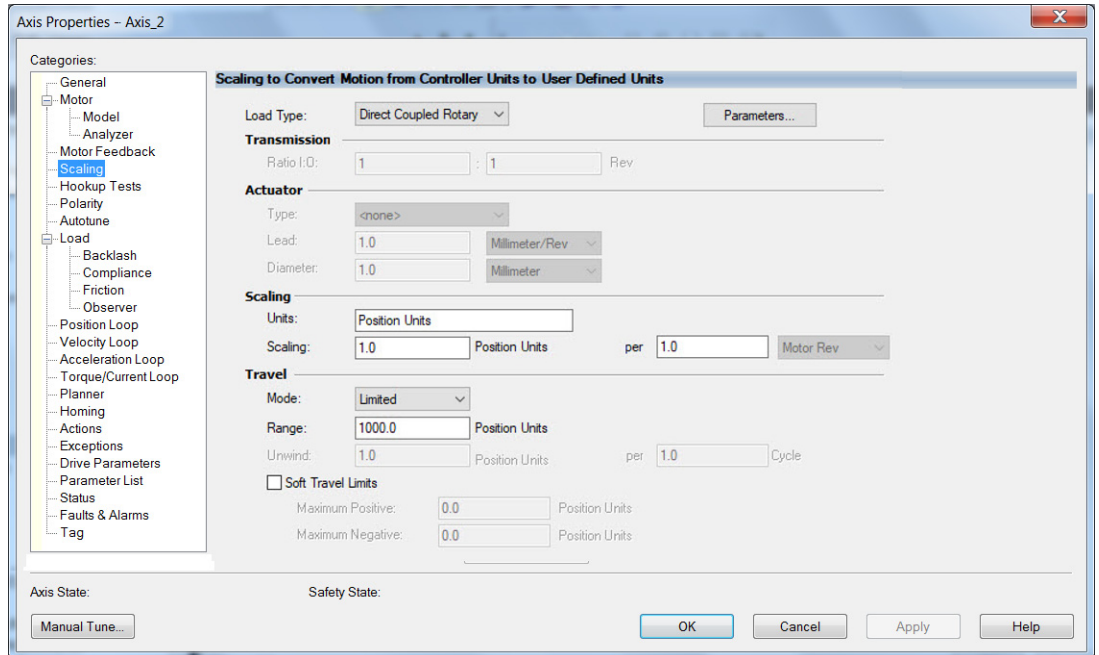

16. Click Apply, if you make changes.
17. Select the Actions category.

The Actions to Take Upon Conditions dialog box appears.

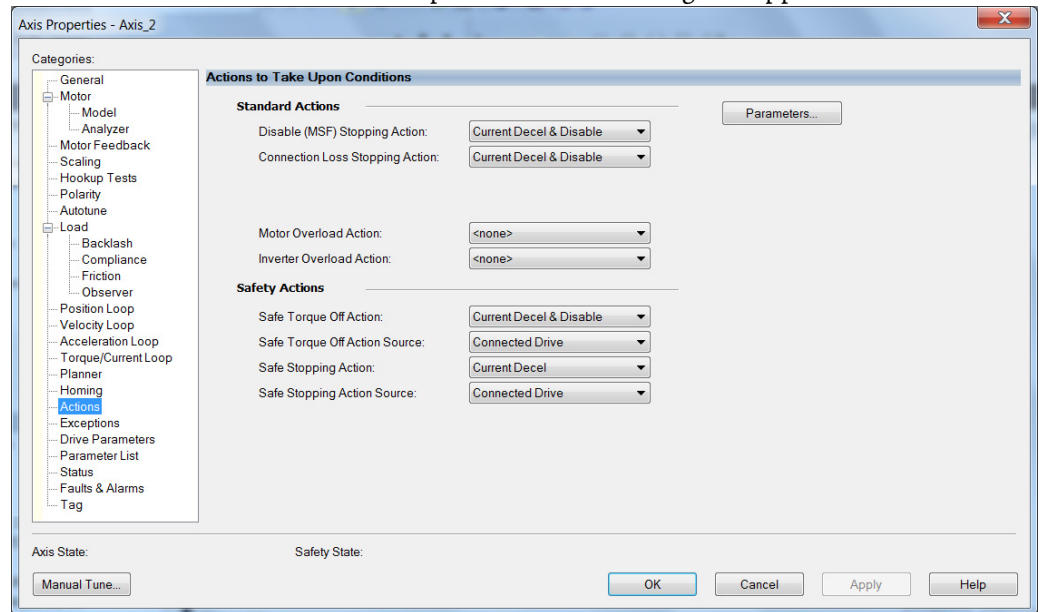

From this dialog box, you can program actions for the drive module to take. For more information, see [Logix 5000 Controller and Drive Behavior on page 145](#).

18. Select the Exceptions category.

The Action to Take Upon Exception Condition dialog box appears.

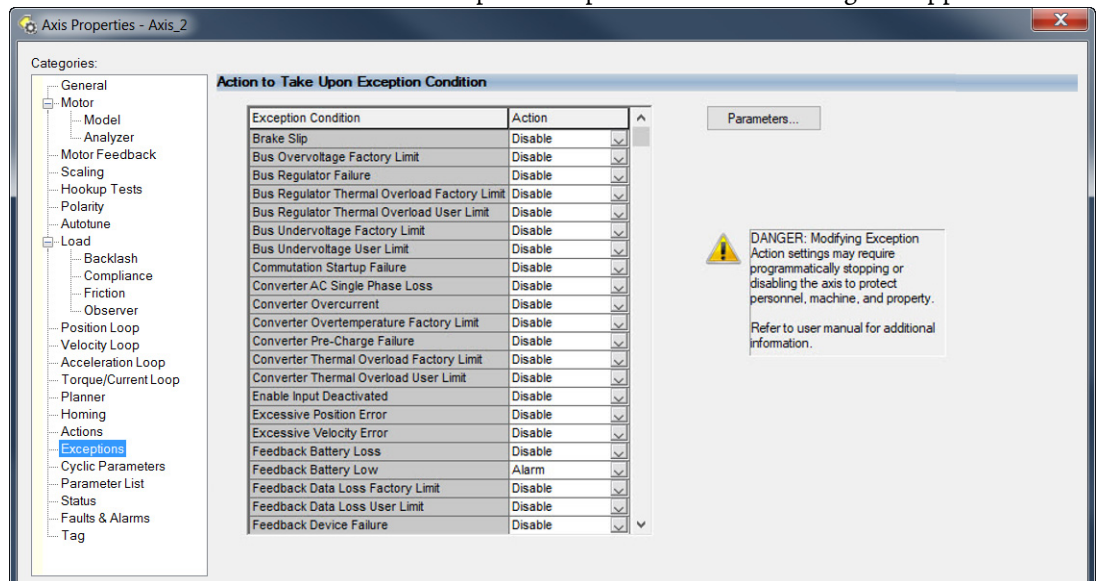

From this dialog box, you can change the action for exceptions (faults). For more information, see [Logix 5000 Controller and Drive Behavior on page 145](#).



In the Logix Designer application, version 32.00 and later, Disable replaced StopDrive as the default Action.

19. Select the Load category and edit the default values as appropriate for your application.

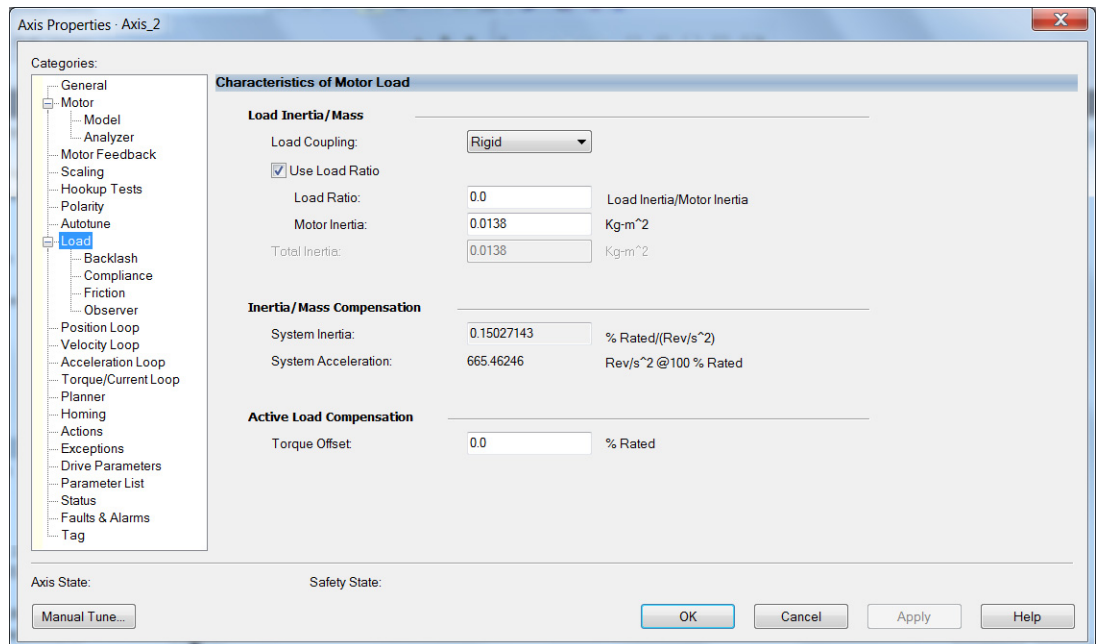

20. Click Apply, if you make changes.

21. Click OK.

22. Select the Motor > Model category.

Motor model attributes are automatically estimated from the Nameplate/Datasheet parameters. For improved performance, motor tests can be run.

23. The Analyze Motor to Determine Motor Model dialog box opens.

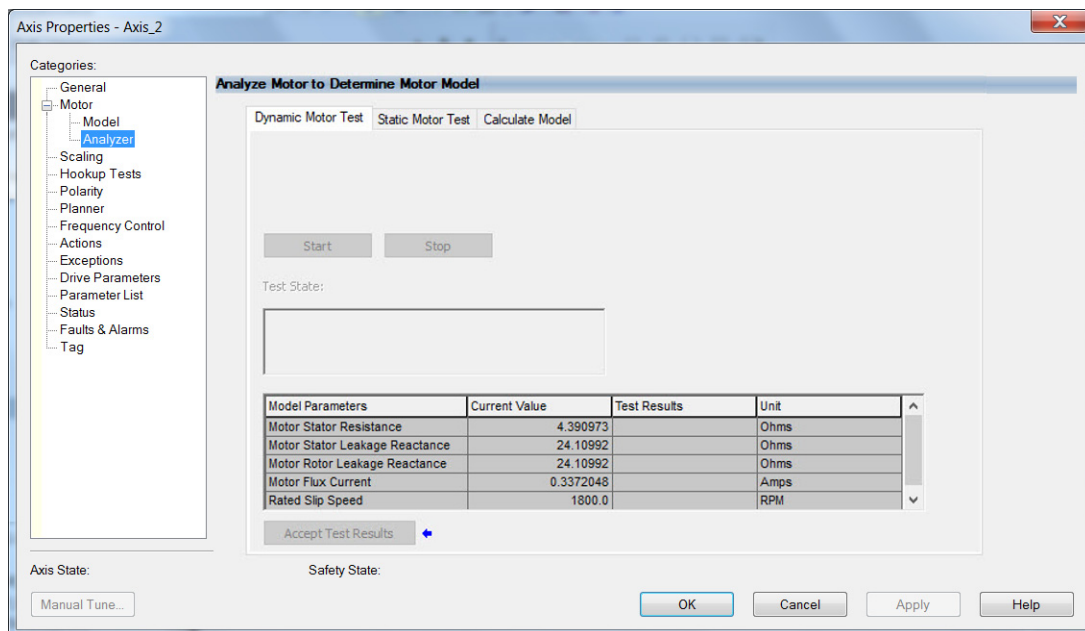

24. Click the tab that corresponds to the Motor Test you want to run.  
For information about each of the tests, see [Motor Tests and Autotune Procedure on page 214](#).
25. Click Start.
26. Click Accept Test Results.
27. Click Apply.
28. Select the Autotune category.
29. Repeat [step 1](#) through [step 29](#) for each induction motor axis.

## Configure Feedback Properties

This section provides more configuration detail for module properties and axis properties when incremental feedback types are used in your application.

### Configure Module Properties

Configure the module properties of your Kinetix 5300 servo drive depending on how you intend to use the feedback connectors.

1. Right-click a drive in the Controller Organizer to configure and choose Properties.  
The Module Properties dialog box appears.
2. Select the Associated Axes category.

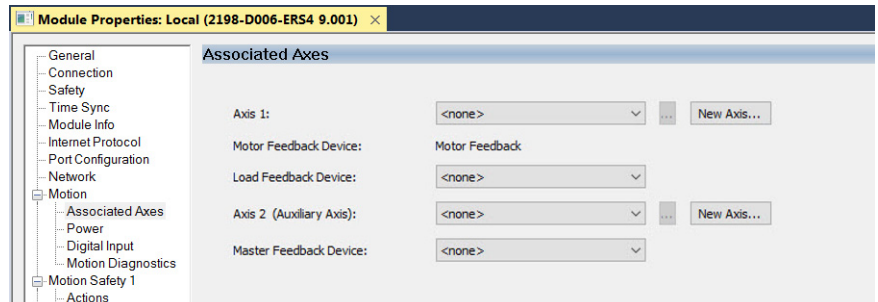

3. Configure each axis for Motor feedback, Load feedback, and Master feedback devices appropriate for your application.

**IMPORTANT** The Logix Designer application prevents making feedback port assignments with incompatible feedback types. For example, you cannot assign the same port for multiple devices. The same port cannot be used for Motor Feedback Device, Load Feedback Device, and Master Feedback Device.

See [Table 63](#) for motor feedback configuration options.

**IMPORTANT** Unprogrammed Smart feedback devices are not supported. Unprogrammed as load or feedback-only feedback types are supported. Contact your local distributor or Rockwell Automation representative for support options.

This example shows acceptable feedback port assignments.

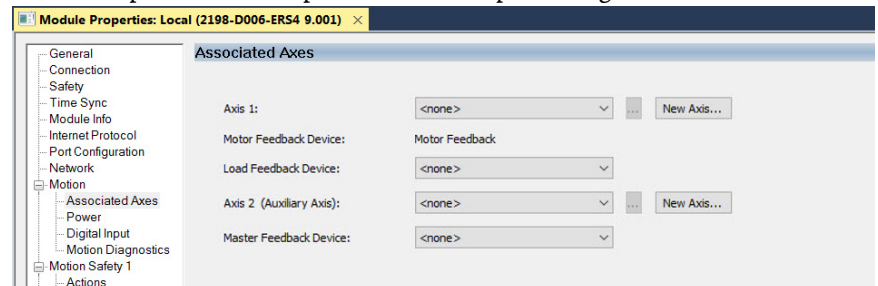

4. Click OK.

## Configure Axis Properties

In this section, you configure the axis properties of your Kinetix 5300 servo drive for the type of feedback that you intend to use in your application.

**Table 64 - Valid Feedback Assignments**

Feedback Type		Permanent Magnet Motors		Induction Motors		
		Motor Feedback	Load Feedback	Motor Feedback	Load Feedback	
Hiperface <sup>(1)</sup>	High-resolution single-turn and multi-turn, absolute	Supported	-	-	-	
Nikon <sup>(1)</sup>						
Tamagawa <sup>(1)</sup>						
Digital AqB <sup>(2)</sup>	Incremental	Supported	Supported	Supported	Supported	
Digital AqB with UVW <sup>(2)</sup>						
Sine/Cosine <sup>(2)</sup>				-	-	-
Sine/Cosine with UVW <sup>(2)</sup>						

- (1) This feedback option is automatically configured via the motor catalog number.
- (2) See the sections that follow for the respective information to configure this feedback type.

**IMPORTANT** The following examples are applicable when the motor Data Source is the Nameplate Datasheet. When selecting a motor via the Catalog Number, the appropriate fields are automatically populated.

### Digital AqB (TTL) Feedback

In this example, a motor feedback device is configured for Digital AqB feedback.

1. In the Controller Organizer, right-click an axis and choose Properties.
2. Select the Motor Feedback category.

The Motor Feedback Device Specification dialog box appears.

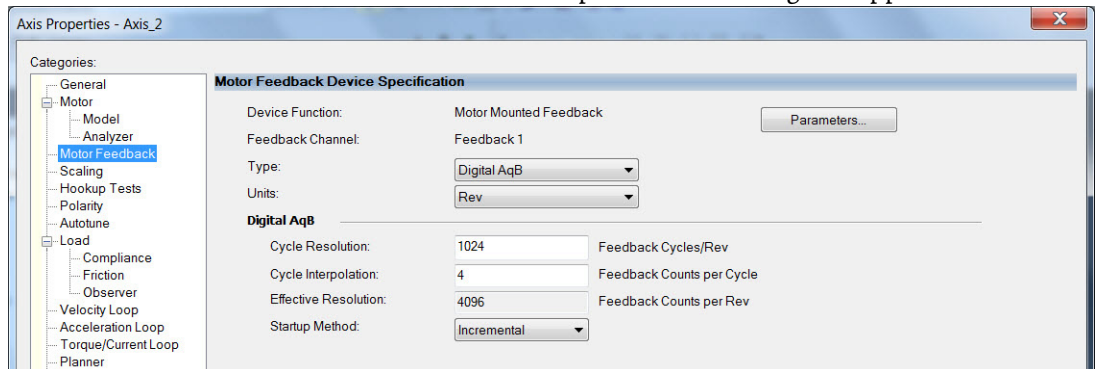

3. Configure the device function and type.  
In this example, Motor Feedback is the device function and Digital AqB is the feedback type.
4. Enter values for the Digital AqB specification fields.  
The only valid value for Cycle Interpolation is 4.
5. From the Startup Method pull-down menu, choose Incremental.
6. Click Apply.



When the Device Function is Load-Side Feedback or Master Feedback, the configuration is identical to Motor Mounted Feedback.

### Digital AqB with UVW (TTL w/Hall) Feedback

In this example, a motor feedback device is configured for Digital AqB with UVW feedback.

1. In the Controller Organizer, right-click an axis and choose Properties.
2. Select the Motor Feedback category.

The Motor Feedback Device Specification dialog box appears.

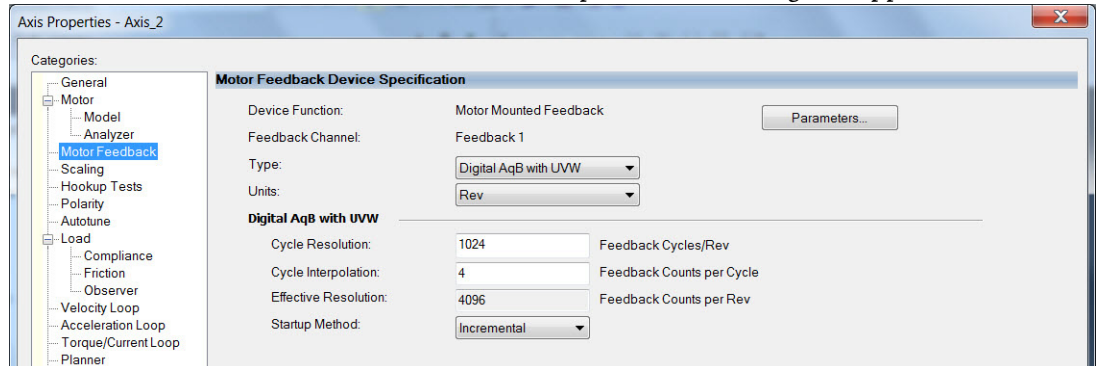

3. Configure the device function and type.  
In this example, Motor Feedback is the device function and Digital AqB with UVW is the feedback type.
4. Enter values for the Digital AqB with UVW specification fields.  
The only valid value for Cycle Interpolation is 4.
5. From the Startup Method pull-down menu, choose Incremental.
6. From the Alignment pull-down menu, choose Not Aligned.
7. Click Apply.

## Sine/Cosine Feedback

In this example, a motor feedback device is configured for Sine/Cosine feedback.

1. In the Controller Organizer, right-click an axis and choose Properties.
2. Select the Motor Feedback category.

The Motor Feedback Device Specification dialog box appears.

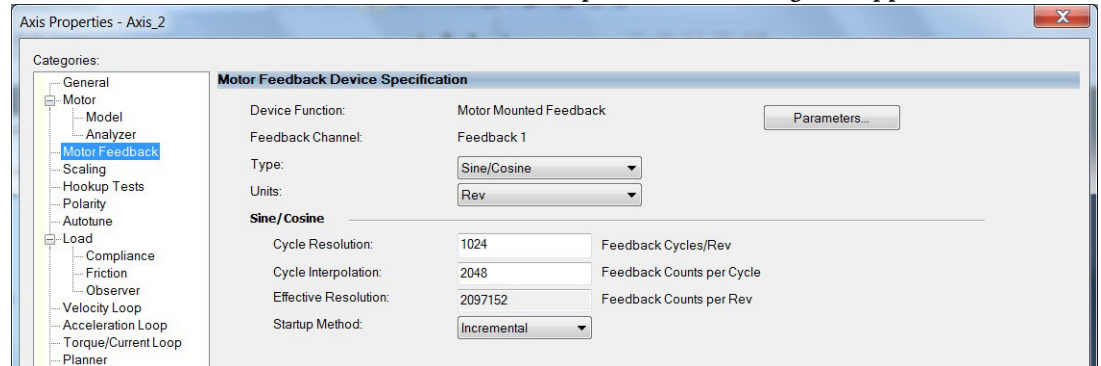

3. Configure the device function and type.  
In this example, Motor Feedback is the device function and Sine/Cosine is the feedback type.
4. Enter values for the Sine/Cosine specification fields.  
The only valid values for Cycle Interpolation are powers of 2 from 4 through 65536.
5. From the Startup Method pull-down menu, choose Incremental.
6. Click Apply.



When the Device Function is Master Feedback, the configuration is identical to Motor Mounted Feedback.



## Sine/Cosine with Hall Feedback

In this example, a motor feedback device is configured for Sine/Cosine with UVW feedback.

1. In the Controller Organizer, right-click an axis and choose Properties.
2. Select the Motor Feedback category.

The Motor Feedback Device Specification dialog box appears.

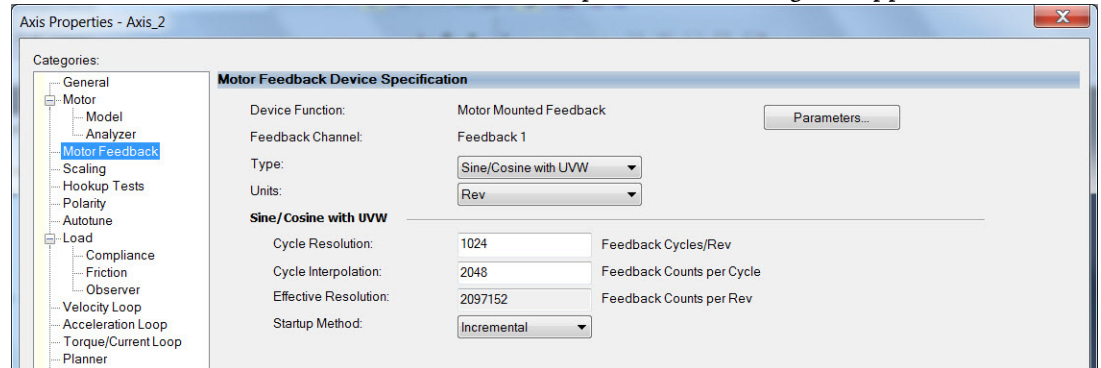

3. Configure the device function and type.  
In this example, Motor Feedback is the device function and Sine/Cosine with UVW is the feedback type.
4. Enter values for the Sine/Cosine with UVW specification fields.  
The only valid values for Cycle Interpolation are powers of 2 from 4 through 65536.
5. From the Startup Method pull-down menu, choose Incremental.
6. From the Alignment pull-down menu, choose Not Aligned.
7. Click OK.

## Apply Power to the Kinetix 5300 Drive

This procedure assumes that you have wired and configured your Kinetix 5300 system and your Logix 5000 controller.

---

**IMPORTANT** When 24V power is first applied, the fan turns on for a few seconds and then, off. It only turns back on if the drive is above a factory configured temperature threshold or the drive is enabled.

---



**SHOCK HAZARD:** To avoid the hazard of electrical shock, perform all mounting and wiring of the Kinetix 5300 servo drives before applying power. After power is applied, connector terminals can have voltage present even when not in use.

---

Follow these steps to apply power to the Kinetix 5300 system.

1. Disconnect the load to the motor.



**ATTENTION:** To avoid personal injury or damage to equipment, disconnect the load to the motor. Make sure that each motor is free of all linkages when initially applying power to the system.

---

2. Apply 24V DC control power.  
The four-segment status display begins the startup sequence. See [Startup Sequence on page 104](#). If the startup sequence does not begin, check the 24V control power connections.
3. When the startup sequence completes, verify that the two status indicators are steady green and the four-character stats displays -03-, meaning the axis state is in Pre-charge.

If the axis state does not reach -03- and the two status indicators are not steady green, see [Kinetix 5300 Drive Status Indicators on page 143](#) and [Four-character Display Axis and Status Device States on page 104](#) for additional information.

---

**IMPORTANT** Apply control power before applying AC input power. Doing so ensures that the shunt is enabled, which can help prevent nuisance faults or Bus Overvoltage faults.

---

4. Apply AC input power and monitor the DC BUS voltage on the four-segment status display. See [View the DC Bus Voltage](#) for additional information.

If the DC Bus does not reach the expected voltage level, check the AC input power connections. Also, it can take as many as 2.5 seconds after AC input power is applied before the drive can accept motion commands.

5. Verify that the four-character status displays -04-, meaning the axis state changes to Stop State.

If the axis state does not change to -04-, refer to [Fault Code Overview on page 142](#) and [Four-character Display Axis and Status Device States on page 104](#) for additional information.

## Test and Tune the Axes

This procedure assumes that you have configured your Kinetix 5300 drive, configured your Logix 5000 controller, and applied power to the system.

---

**IMPORTANT** Before proceeding with testing and tuning your axes, verify that the MOD and NET status indicators are operating as described in [Kinetix 5300 Drive Status Indicators on page 143](#).

---

For help with using the Logix Designer application as it applies to testing and tuning your axes with ControlLogix EtherNet/IP modules or CompactLogix 5380 controllers, refer to [Additional Resources on page 10](#).

Also, see Motor Nameplate Datasheet Entry for Custom Motor Applications, publication [2198-AT002](#), for detailed information on testing and tuning custom motors.

### Test the Axes

Follow these steps to test the axes.

1. Verify that the load was removed from each axis.





---

**ATTENTION:** To avoid personal injury or damage to equipment, you must remove the load from each axis as uncontrolled motion can occur when an axis with an integral motor brake is released during the test.

---

2. In your Motion Group folder, right-click an axis and choose Properties.

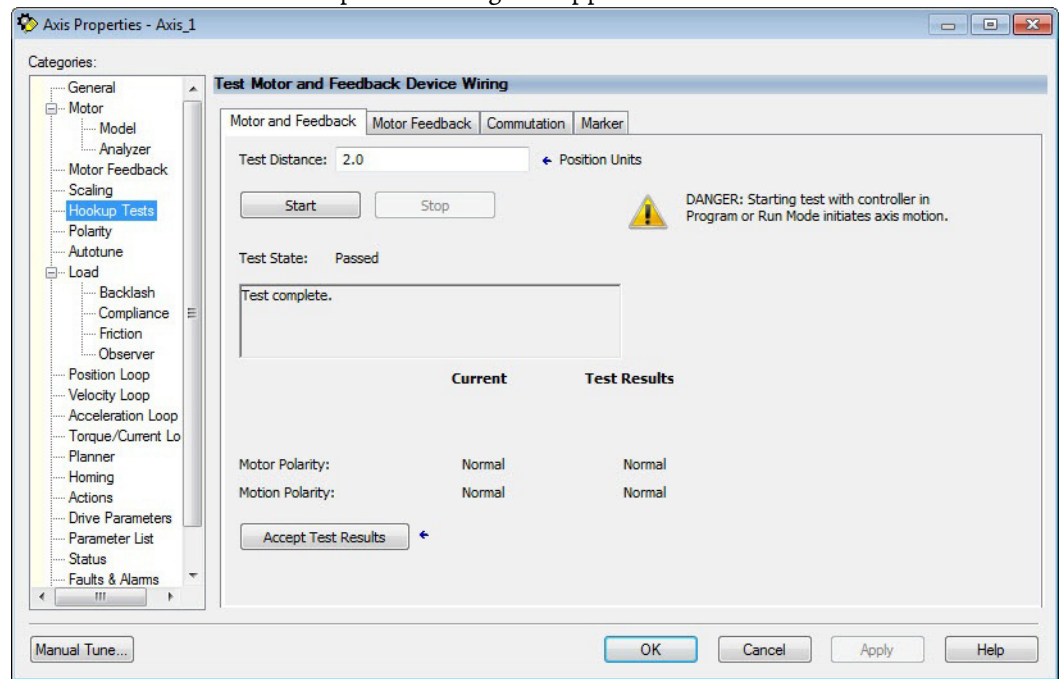
The Axis Properties dialog box appears.



3. Select the Hookup Tests category.
4. In the Test Distance field, enter the desired test distance.

The Position Units are defined in Axis Properties > Scaling category.

Hookup Test	Definitions
Marker	Verifies marker detection capability as you manually rotate the motor shaft. The test completes when the drive either detects the marker or when the motor moves the distance that is specified in the Test Distance field. If the marker remains undetected and the test completes successfully, it means that the motor moved the full test distance. If the marker remains undetected and the test fails, the motor did not move the full test distance. Run this test after running the Motor Feedback and Motor and Feedback tests.
Commutation	Verifies the commutation offset and commutation polarity of the motor. This test is required for third-party or custom permanent-magnet motors that are not available as a catalog number in the Motion Database. For more information, see <a href="#">Commutation Test on page 237</a> .
Motor Feedback	Verifies that feedback connections are wired correctly as you manually rotate the motor shaft. The test completes when the drive determines that the motor moved the full distance that is specified in the Test Distance field. Run this test before the Motor and Feedback Test to verify that the feedback can be read properly.
Motor and Feedback	Verifies that motor power and feedback connections are wired correctly as the drive commands the motor to rotate. Because the drive is rotating the motor, this test requires full bus power to run. Run the Motor Feedback test before running this test to verify that the feedback is being read correctly.

5. To verify connections, click the test you want.
6. Click Start.

The Logix Designer - Motor and Feedback Test dialog box appears. The Test State is Executing.

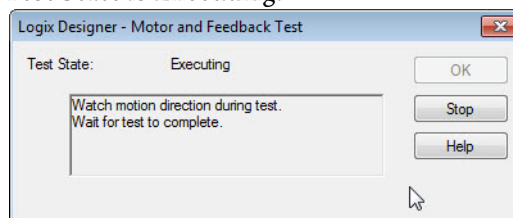

When the test completes successfully, the Test State changes from Executing to Passed.

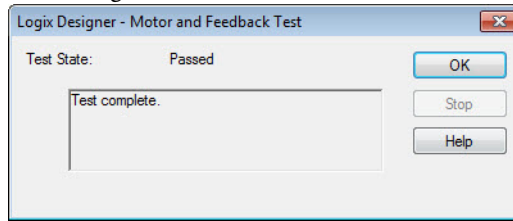

7. Click OK.
8. This dialog box appears asking if the axis moved in the forward direction.
9. Click Yes if you agree.
10. Click Accept Test Results.
  - a. Click OK.
  - b. Verify the DC bus voltage.
  - c. Verify unit values entered in the Scaling category.
  - d. Verify the motor power and feedback wiring.
  - e. Return to [step 5](#) and run the test again.

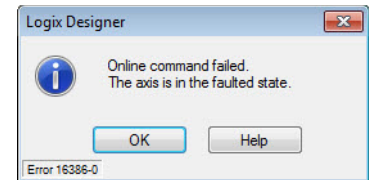
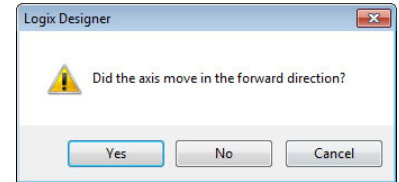

## Tune the Axes

The Kinetix 5300 drives are configured for tuningless operation by default. If additional tuning is required, see the Motion System Tuning Application Technique, publication [MOTION-AT005](#), for more information.

## Troubleshoot the Kinetix 5300 Drive System

This chapter provides troubleshooting tables and related information for your Kinetix® 5300 servo drives.

Topic	Page
Safety Precautions	141
Interpret Status Indicators	141
General Troubleshooting	144
Logix 5000 Controller and Drive Behavior	145
Web Server Interface	150

### Safety Precautions

Observe the following safety precautions when troubleshooting your Kinetix 5300 servo drive.



**ATTENTION:** Before working on the drive, wait 5 minutes as indicated in the warning on the front of the drive. Failure to observe this precaution could result in severe bodily injury or loss of life.



**ATTENTION:** Do not attempt to defeat or override the drive fault circuits. You must determine the cause of a fault and correct it before you attempt to operate the system. Failure to correct the fault could result in personal injury and/or damage to equipment as a result of uncontrolled machine operation.



**ATTENTION:** Provide an earth ground for test equipment (oscilloscope) used in troubleshooting. Failure to ground the test equipment could result in personal injury.

### Interpret Status Indicators

Use this troubleshooting information to identify faults, potential causes, and the appropriate actions to resolve the fault. If the fault persists after attempting to troubleshoot the system, contact your Rockwell Automation sales representative for further assistance.

## Fault Code Overview

The four-position status display provides fault codes when a drive fault occurs. The fault code tables are designed to help you determine the source of the fault or exception. When a fault condition is detected, the drive performs the appropriate fault action and the fault is displayed.

The drive removes the fault text from the display when a Fault Reset service is sent from the controller and the fault is no longer active. If a fault is still active following a Fault Reset service, the fault is again posted to the display.

However, there is a delay before the fault is posted again. In a Studio 5000 Logix Designer® application, this delay results as the AxisFault tag on the drive axis being cleared until the fault is posted again. During this delay, the AxisState tag continues to indicate that the axis is faulted. Use the AxisState tag on the axis object and only to determine if an axis is faulted.

Although software overtravel fault codes do not exist, software overtravel detection for the AXIS\_CIP\_DRIVE axis type is determined in the Logix 5000® controller. For more information, see Integrated Motion on the EtherNet/IP™ Network Reference Manual, publication [MOTION-RM003](#).

**Table 65 - Fault Code Summary**

Fault Code Type <sup>(1)</sup> ( <sup>2</sup> )	Description
Fxx	Standard runtime axis exceptions. The exception can apply to an individual axis or to all axes.
Fcxx	Manufacturer-specific runtime axis exception. The exception can apply to an individual axis or to all axes.
lxx	Exceptions that prevent normal operation and occur during the initialization process.
lcxx	
nFxx	Exceptions that can prevent normal operation of the drive module and apply to the entire module and affect all axes.
nAxx	Exceptions that can prevent normal operation of the drive module, but do not result in any action other than reporting the alarm to the controller.
Sxx	Conditions that prevent normal operation and indicate that the drive module is prevented from being enabled.
Scxx	
Axx	An underlying exception condition that does not result in any action other than reporting the alarm to the controller.
Acxx	
SFxx	Exception that is generated by a fault condition that is detected in the safety function.
SFcxx	

(1) Fxx refers to Standard exceptions.

(2) When the fault code type contains 'c', this indicates a manufacturer-specific exception. For example, Fcxx.

The display indicates progress through the Initializing state and various fault, alarm, and inhibit conditions. The display supports the following mapping to various conditions of the device.

**Table 66 - Four-position Status Display**

Display Digit	Device Condition
8888	Executing device self-test
00	Waiting for connection to controller
01	Configuring device attributes
02	Waiting for group synchronization
03	Waiting for DC-bus to charge
04	Device is operational

## Fault Codes



This manual links to Kinetix 5300 Single-axis EtherNet/IP Servo Drives Fault Codes Reference Data, publication [2198-RD006](#), for fault codes. Download the spreadsheet now for offline access.

## Kinetix 5300 Drive Status Indicators

The module status and network status indicators are just below the four-character display.

**IMPORTANT** Status indicators are not reliable for safety functions. Use them only for general diagnostics during commissioning or troubleshooting. Do not attempt to use status indicators to determine operational status.

**Table 67 - Module Status Indicator**

Condition	Status
Steady Off	No power applied to the drive.
Steady Green	Drive is operational. No faults or failures.
Flashing Green	Standby (drive not configured).
Flashing Red	Major recoverable fault. The drive detected a recoverable fault, for example, an incorrect or inconsistent configuration.
Steady Red	Major fault. The drive detected a nonrecoverable fault.
Flashing Green/Red	Self-test. The drive performs self-test during powerup.

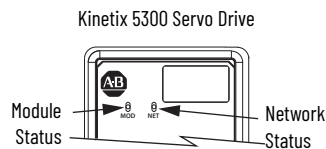

**Table 68 - Network Status Indicator**

Condition	Status
Steady Off	No power applied to the drive or IP address is not configured.
Flashing Green	Drive connection is not established, but has obtained an IP address.
Steady Green	Drive connection is established. Normal operation.
Flashing Red	Connection timeout. One or more of the connections, for which this drive is the target, has timed out.
Steady Red	Duplicate IP address. IP address that is specified is already in use.
Flashing Green/Red	Self-test. The drive performs self-test during powerup.

**Table 69 - Ethernet Link Speed Status Indicator**

Condition	Status
Steady Off	10 Mbit
Steady On	100 Mbit

**Table 70 - Ethernet Link/Activity Status Indicator**

Condition	Status
Steady Off	No link
Steady On	Link established
Blinking	Network activity

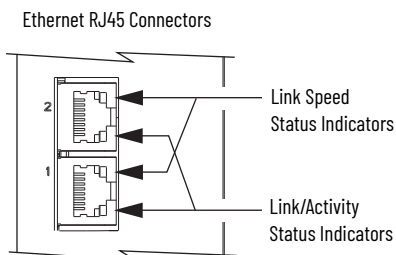

## General Troubleshooting

These conditions do not always result in a fault code, but can require troubleshooting to improve performance.

**Table 71 - General Troubleshooting**

Condition	Potential Cause	Possible Resolution
Axis or system is unstable.	The position feedback device is incorrect or open.	Check wiring.
	Unintentionally in Torque mode.	Check to see what primary operation mode was programmed.
	Motor tuning limits are set too high.	Decrease tuning gains. See Motion System Tuning Application Technique, publication <a href="#">MOTION-AT005</a> .
	Position loop gain or position controller accel/decel rate is improperly set.	Change the command profile to reduce accel/decel or increase time.
	Improper grounding or shielding techniques are causing noise to be transmitted into the position feedback or velocity command lines, causing erratic axis movement.	Check wiring and ground.
	Motor Select limit is incorrectly set (servo motor is not matched to axis module).	Check setups.
	Mechanical resonance.	<ul style="list-style-type: none"> <li>Notch filter or output filter can be required (refer to Axis Properties dialog box, Compliance tab in the Logix Designer application).</li> <li>Enable adaptive tuning. For more notch filter information, see <a href="#">Adaptive Tuning on page 238</a>.</li> </ul>
You cannot obtain the motor acceleration/deceleration that you want.	Torque Limit limits are set too low.	Verify that torque limits are set properly.
	Incorrect motor selected in configuration.	Select the correct motor in the Logix Designer application again.
	The system inertia is excessive.	<ul style="list-style-type: none"> <li>Check motor size versus application need.</li> <li>Review servo system sizing.</li> </ul>
	The system friction torque is excessive.	Check motor size versus application need.
	Available current is insufficient to supply the correct accel/decel rate.	<ul style="list-style-type: none"> <li>Check motor size versus application need.</li> <li>Review servo system sizing.</li> </ul>
	Acceleration limit is incorrect.	Verify limit settings and correct them, as necessary.
	Velocity Limit limits are incorrect.	Verify limit settings and correct them, as necessary.
	The motor is operating in the field-weakening range of operation.	Reduce the commanded acceleration or deceleration.
Motor does not respond to a command.	The axis cannot be enabled until stopping time has expired.	Disable the axis, wait for 1.5 seconds, and enable the axis.
	The motor wiring is open.	Check the wiring.
	The motor cable shield connection is improper.	<ul style="list-style-type: none"> <li>Check feedback connections.</li> <li>Check cable shield connections.</li> </ul>
	The motor has malfunctioned.	Repair or replace the motor.
	The coupling between motor and machine has broken (for example, the motor moves, but the load/machine does not).	Check and correct the mechanics.
	Primary operation mode is set incorrectly.	Check and properly set the operation mode.
	Velocity or torque limits are set incorrectly.	Check and properly set the limits.
	Brake connector not wired	Check brake wiring
Presence of noise on command or motor feedback signal wires.	Recommended grounding per installation instructions have not been followed.	<ul style="list-style-type: none"> <li>Verify grounding.</li> <li>Route wire away from noise sources.</li> <li>See System Design for Control of Electrical Noise, publication <a href="#">GMC-RM001</a>.</li> </ul>
	Line frequency can be present.	<ul style="list-style-type: none"> <li>Verify grounding.</li> <li>Route wire away from noise sources.</li> </ul>
	Variable frequency can be velocity feedback ripple or a disturbance that is caused by gear teeth or ballscrew, and so forth. The frequency can be a multiple of the motor power transmission components or ballscrew speeds resulting in velocity disturbance.	<ul style="list-style-type: none"> <li>Decouple the motor for verification.</li> <li>Check and improve mechanical performance, for example, the gearbox or ballscrew mechanism.</li> </ul>
No rotation	The motor connections are loose or open.	Check motor wiring and connections.
	Foreign matter is lodged in the motor.	Remove foreign matter.
	The motor load is excessive.	Verify the servo system sizing.
	The bearings are worn.	Return the motor for repair.
	The motor brake is engaged (if supplied).	<ul style="list-style-type: none"> <li>Check brake wiring and function.</li> <li>Return the motor for repair.</li> </ul>
	The motor is not connected to the load.	Check coupling.



Table 71 - General Troubleshooting (Continued)

Condition	Potential Cause	Possible Resolution
Motor overheating	The duty cycle is excessive.	Change the command profile to reduce accel/decel or increase time.
	The rotor is partially demagnetized causing excessive motor current.	Return the motor for repair.
Abnormal noise	Motor tuning limits are set too high.	Decrease tuning gains. See Motion System Tuning Application Technique, publication <a href="#">MOTION-ATO05</a> .
	Loose parts are present in the motor.	<ul style="list-style-type: none"> <li>Remove the loose parts.</li> <li>Return motor for repair.</li> <li>Replace motor.</li> </ul>
	The through bolts are loose or the coupling is loose.	Tighten bolts.
	The bearings are worn.	Return motor for repair.
	Mechanical resonance.	Notch filter can be required (see the Axis Properties dialog box, Compliance tab in the Logix Designer application).
Erratic operation - Motor locks into position, runs without control or with reduced torque.	Motor power phases U and V, U and W, or V and W reversed.	Check and correct motor power wiring.

## Logix 5000 Controller and Drive Behavior

By using the Logix Designer application, you can configure how the Kinetix 5300 drives respond when a drive fault/exception occurs.



lxxx faults are always generated after powerup, but before the drive is enabled, so the stopping behavior does not apply.

nAxx faults do not apply because they do not trigger stopping behavior.

The drive supports exception actions for Ignore, Alarm, Minor Fault, and Major Fault as defined in [Table 72](#). However, these exception actions cannot be changed online. The drive also supports five configurable stopping actions as defined in [Table 74](#).

Table 72 - Kinetix 5300 Drive Exception Action Definitions

Exception Action	Definition
Ignore	The drive completely ignores the exception condition. For some exceptions that are fundamental to the operation of the planner, Ignore is not an available option.
Alarm	The drive sets the associated bit in the Motion Alarm Status word, but does not otherwise affect axis behavior. Like Ignore, if the exception is so fundamental to the drive, Alarm is not an available option. When an exception action is set to Alarm, the Alarm goes away by itself when the exceptional condition has cleared.
Minor Fault	The drive latches the exception condition but the drive does not execute any exception action.
Major Fault	The drive latches the exception condition and executes the configured exception action.

You can configure exception behavior in the Logix Designer application from the Axis Properties dialog box, Actions category. These controller exception actions are mapped to the drive exception actions.

**Table 73 - Logix Designer Application Exception Action Definitions**

Exception Action	Definition
Ignore	The controller completely ignores the exception condition. For some exceptions that are fundamental to the operation of the planner, Ignore is not an available option.
Alarm	The controller sets the associated bit in the Motion Alarm Status word, but does not otherwise affect axis behavior. Like Ignore, if the exception is so fundamental to the drive, Alarm is not an available option. When an exception action is set to Alarm, the Alarm goes away by itself when the exceptional condition has cleared.
Fault Status Only	Like Alarm, Fault Status Only instructs the controller to set the associated bit in the Motion Fault Status word, but does not otherwise affect axis behavior. However, unlike Alarm, an explicit Fault Reset is required to clear the fault once the exceptional condition has cleared. Like Ignore and Alarm, if the exception is so fundamental to the drive, Fault Status Only is not an available option.
Stop Planner	The controller sets the associated bit in the Motion Fault Status word and instructs the Motion Planner to perform a controlled stop of all planned motion at the configured maximum deceleration rate. An explicit Fault Reset is required to clear the fault once the exceptional condition has cleared. If the exception is so fundamental to the drive, Stop Planner is not an available option.
StopDrive (version 31 and earlier) Disable (version 32 and later)	When the exception occurs, the associated bit in the Fault Status word is set and the axis comes to a stop by using the stopping action that is defined by the drive for the particular exception that occurred. There is no controller-based configuration to specify what the stopping action is, the stopping action is device-dependent.
Shutdown	When the exception occurs, the drive brings the motor to a stop by using the stopping action defined by the drive (as in Stop Drive) and the power module is disabled. An explicit Shutdown Reset is required to restore the drive to operation.

For Kinetix 5300 drives, only selected exceptions are configurable. In the drive behavior tables, the controlling attribute is given for programmable fault actions.

**Table 74 - Configurable Stopping Actions**

Stopping Action	Description
Ramped Decel & Hold <sup>(1)</sup>	Most control
Current Decel & Hold	Most control
Ramped Decel & Disable <sup>(1)</sup>	Less control
Current Decel & Disable	Less control
Disable & Coast <sup>(2)</sup>	Least control

The best available stopping action is the one that maintains the most control over the motor. However, not all faults support every stopping action.

(1) Ramped Decel is available only when General > Axis Configuration is set to Velocity Loop or Frequency Control.  
 (2) When configured for Frequency Control (induction motors only), select Decel & Disable only when the Current Limiting feature is enabled. For more information on this feature, see [Current Limiting for Frequency Control on page 202](#).

Actions define the drive behavior in response to specific conditions. The Actions category includes Standard Actions and Safety Actions.

**Table 75 - Actions Definitions**

Action Category	Action Name	Action Trigger Condition	Available Actions
Standard	Disable (MSF) Stopping Action	Execution of an MSF motion instruction.	<ul style="list-style-type: none"> <li>Ramped Decel &amp; Hold</li> <li>Current Decel &amp; Hold</li> <li>Ramped Decel &amp; Disable</li> <li>Current Decel &amp; Disable</li> <li>Disable &amp; Coast</li> </ul>
	Connection Loss Stopping Action	Loss of the motion connection (for example, inhibiting the module or a network cable disconnect).	<ul style="list-style-type: none"> <li>Ramped Decel &amp; Disable</li> <li>Current Decel &amp; Disable</li> <li>Disable &amp; Coast</li> </ul>
	Motor Overload Action	Receiving MTR OVERLOAD fault.	<ul style="list-style-type: none"> <li>Current Foldback</li> <li>None</li> </ul>
	Inverter Overload Action	Receiving INV OVERLOAD fault.	<ul style="list-style-type: none"> <li>Current Foldback</li> <li>None</li> </ul>
Safety	Safe Torque Off Action	Transition from logic 0 to 1 of the SafeTorqueOffActiveStatus axis tag, which indicates a Safe Torque Off (STO) action was commanded. <sup>(1)</sup>	Disable & Coast

(1) This action is executed only if the axis tag transitions due to a requested STO.

When configured for Frequency Control (IM motors only), Decel & Disable should only be selected when the Current Limiting feature has been enabled. For more information on this feature, refer to [Appendix C on page 197](#).

Only selected drive exceptions are configurable. In the drive behavior tables, the controlling attribute is given for programmable fault actions.



In the Logix Designer application, version 32 or later, Disable replaced StopDrive as the default Action.

**Figure 59 - Logix Designer Application Axis Properties - Exceptions Category**

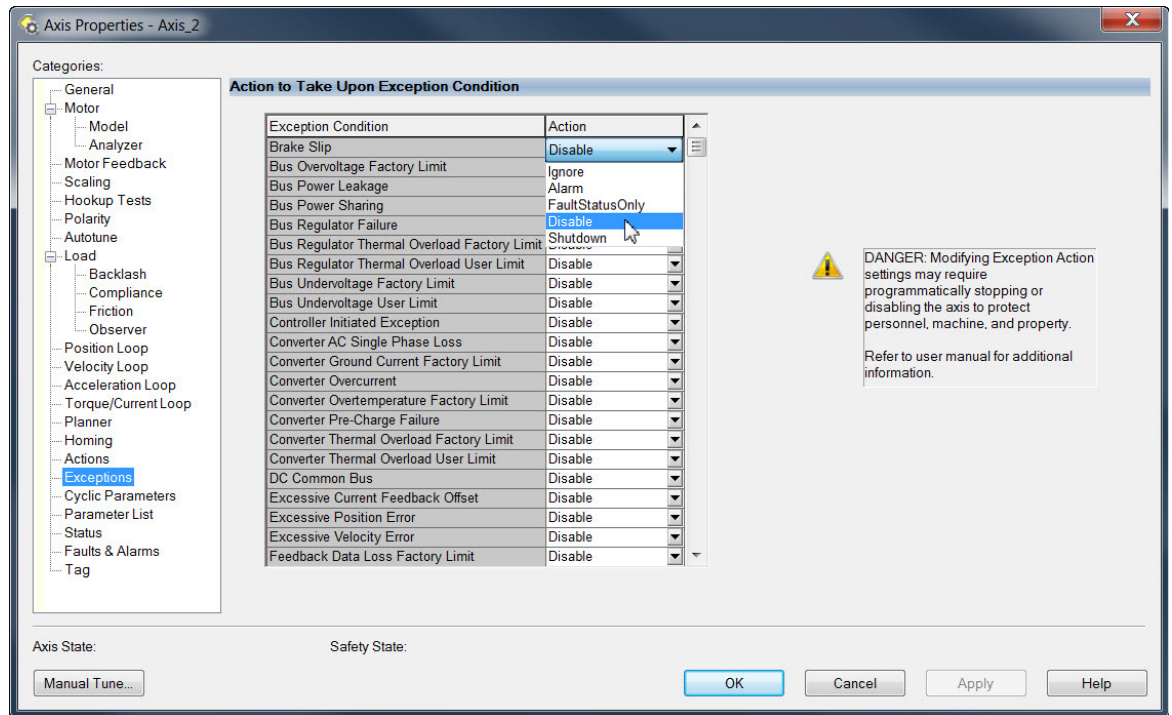

This dialog box applies to Kinetix 5300 servo drives.

**Table 76 - Drive Behavior, Fxx Fault Codes**

Exception Fault Code	Exception Text	Permanent Magnet Motor	Induction Motor	Fault Action				Best Available Stopping Action (applies to major faults)
				Ignore	Alarm	Minor Fault	Major Fault	
F02	Motor Commutation Fault	X	-	-	-	-	X	Disable/Coast
F03 <sup>(1)</sup>	Motor Overspeed Factory Limit Fault	X	X	-	-	-	X	Disable/Coast
F04 <sup>(1)</sup>	Motor Overspeed User Limit Fault	X	X	X	X	X	X	Ramped Decel <sup>(2)</sup> /Hold
F05	Motor Overtemperature Factory Limit Fault (If #589 vertical load control)	X	X	-	-	-	-	Current Decel/Disable
	Motor Overtemperature Factory Limit Fault (If not #589 vertical load control)			-	-	-	-	Disable/Coast
F07	Motor Thermal Overload Factory Limit Fault	X	X	-	-	-	X	Ramped Decel <sup>(2)</sup> /Disable
F08	Motor Thermal Overload User Limit Fault	X	X	X	X	X	X	Ramped Decel <sup>(2)</sup> /Hold
F09	Motor Phase Loss	X	-	X	X	X	X	Disable/Coast
F10	Inverter Overcurrent Fault	X	X	-	-	-	X	Disable/Coast
F11	Inverter Overtemperature Factory Limit Fault (If #589 vertical load control)	X	X	-	-	-	X	Current Decel/Disable
	Inverter Overtemperature Factory Limit Fault (If not #589 vertical load control)			-	-	-		Disable/Coast
F13	Inverter Thermal Overload Factory Limit Fault	X	X	-	-	-	X	Current Decel/Disable

Table 76 - Drive Behavior, Fxx Fault Codes (Continued)

Exception Fault Code	Exception Text	Permanent Magnet Motor	Induction Motor	Fault Action				Best Available Stopping Action (applies to major faults)
				Ignore	Alarm	Minor Fault	Major Fault	
F14	Inverter Thermal Overload User Limit Fault	X	X	X	X	X	X	Ramped Decel <sup>(2)</sup> /Hold
F15	Converter Overcurrent Fault	X	X	-	-	-	X	Disable/Coast
F18	Converter OverTemp Factory Limit Fault	X	X	-	-	-	X	Disable/Coast
F20	Converter Thermal Overload Factory Limit Fault	X	X	-	-	-	X	Disable/Coast
F21	Converter Thermal Overload User Limit Fault	X	X	X	X	X	X	Decel/Hold
F23	AC Single Phase Loss Fault	X	X	X	X	X	X	Decel/Disable
F25	Pre-charge Failure Fault	X	X	-	-	-	X	Disable/Coast
F29	Bus Regulator Thermal Overload Factory Limit Fault	X	X	-	-	-	X	Disable/Coast
F30	Bus Regulator Thermal Overload User Limit Fault	X	X	X	X	X	X	Decel/Hold
F31	Bus Regulator Failure	X	X	-	-	-	X	Disable/Coast
F33	Bus Undervoltage Factory Limit Fault	X	X	-	-	-	X	Ramped Decel <sup>(2)</sup> /Disable
F34	Bus Undervoltage User Limit Fault	X	X	X	X	X	X	Ramped Decel <sup>(2)</sup> /Hold
F35	Bus Overvoltage Factory Limit Fault	X	X	-	-	-	X	Disable/Coast
F41	Feedback Signal Noise FL	X	X	-	-	-	X	Disable/Coast
F43 <sup>(1)(3)(4)</sup>	Feedback Signal Loss FL	X	X	-	-	-	X	Disable/Coast
F44 <sup>(1)(3)(4)</sup>	Feedback Signal Loss UL	X	X	X	X	X	X	Ramped Decel <sup>(2)</sup> /Hold
F45 <sup>(4)(5)</sup>	Motor Feedback Data Loss Factory Limit Fault	X	X	-	-	-	X	Disable/Coast
F46 <sup>(3)(4)</sup>	Motor Feedback Data Loss User Limit Fault	X	X	X	X	X	X	Ramped Decel <sup>(2)</sup> /Hold
F47	Feedback Device Failure	X	X	-	-	-	X	Disable/Coast
F49	Brake Slip Exception	X	X	X	X	X	X	Ramped Decel <sup>(2)</sup> /Hold
F50	Hardware Overtravel - Positive	X	X	X	X	X	X	Ramped Decel <sup>(2)</sup> /Hold
F51	Hardware Overtravel - Negative	X	X	X	X	X	X	Ramped Decel <sup>(2)</sup> /Hold
F54 <sup>(1)(4)</sup>	Excessive Position Error Fault (If #589 vertical load control)	X	X	X	X	X	X	Current Decel/Disable
	Excessive Position Error Fault (If not #589 vertical load control)							Disable/Coast
F55 <sup>(1)(4)</sup>	Excessive Velocity Error Fault (If #589 vertical load control)	X	X	X	X	X	X	Current Decel/Disable
	Excessive Velocity Error Fault (If not #589 vertical load control)							Disable/Coast
F56 <sup>(4)</sup>	Overtorque Limit Fault	X	X	X	X	X	X	Ramped Decel <sup>(2)</sup> /Hold
F57 <sup>(4)</sup>	Undertorque Limit Fault	X	X	X	X	X	X	Ramped Decel <sup>(2)</sup> /Hold
F61	Enable Input Deactivated	X	X	X	X	X	X	Ramped Decel <sup>(2)</sup> /Disable

- (1) The loss of A/B signals from a TTL encoder isn't detected directly. Typically, this loss of signals is detected through an excessive position/velocity error or a motor overspeed fault. If these secondary faults are set to Ignore (where applicable), then if a signal loss condition occurs, it is not detected (see the following ATTENTION statement for more information).
- (2) Available only in Velocity Control mode. Available stopping action is Current Decel in Position Control mode.
- (3) Applies to all compatible feedback devices.
- (4) Does not apply to induction motors in frequency control mode.
- (5) Applies to Hiperface feedback devices.



**ATTENTION:** The loss of A/B signals from a TTL encoder is not detected directly. Typically, an excessive position/velocity error or a motor overspeed fault detects this. If these secondary faults are set to Ignore (where applicable), a signal loss condition will not be detected. In some cases, particularly in Torque mode, the fault is not detected at all and the motor coasts to a stop. In addition, if you have selected to ignore these secondary faults in the Logix Designer application, the signal loss condition will not be detected. If the secondary fault is not detected, the drive can still be enabled in the Logix Designer application even though the fault condition exists.

Table 77 - Drive Behavior, Fcxx Fault Codes

Exception Fault Code	Exception Text	Permanent Magnet Motor	Induction Motor	Fault Action				Best Available Stopping Action (applies to major faults)
				Ignore	Alarm	Minor Fault	Major Fault	
Fc02 <sup>(1)</sup>	Motor Voltage Mismatch Fault	X	X	X	X	X	X	Disable/Coast
Fc05 <sup>(2)</sup>	Feedback Battery Loss Fault	X	-	-	-	-	X	Disable/Coast
Fc06 <sup>(2)</sup>	Feedback Battery Low Fault	X	-	X	X	X	X	Disable/Coast
Fc07	Feedback Incremental Count Error Exception	X	X	-	-	-	X	Disable/Coast
Fc16	PWM Frequency Reduced Exception	X	X	X	X	X	X	Disable/Coast
Fc26	Runtime Error	X	X	-	-	-	X	Disable/Coast

(1) Does not apply to induction motors in frequency control mode.

(2) Applies to only Kinetix TLP or Kinetix TLY-Axxxx-B encoders.

Table 78 - Drive Behavior, nFxx Fault Codes

Exception Fault Code	Exception Text	Permanent Magnet Motor	Induction Motor	Fault Action				Best Available Stopping Action (applies to major faults)
				Ignore	Alarm	Minor Fault	Major Fault	
nF01	Control Connection Update Fault	X	X	-	-	-	X	Ramped Decel <sup>(1)</sup> /Disable
nF02	Processor Watchdog Fault	X	X	-	-	-	X	Disable/Coast
nF05	Clock Skew Fault	X	X	-	-	-	X	Ramped Decel <sup>(1)</sup> /Disable
nF06	Lost Controller Connection Fault	X	X	-	-	-	X	Programmable per Connection Loss Stopping Action (see <a href="#">Table 75</a> on <a href="#">page 146</a> ).
nF07	Clock Sync Fault	X	X	-	-	-	X	Ramped Decel <sup>(1)</sup> /Disable
nF09	Duplicate IP Address Fault	X	X	-	-	-	X	Disable/Coast

(1) Available only in Velocity Control mode. Available stopping action is Current Decel in Position Control mode.

Table 79 - Drive Behavior, SFxx Fault Codes

Exception Fault Code	Exception Text	Permanent Magnet Motor	Induction Motor	Fault Action				Best Available Stopping Action (applies to major faults)
				Ignore	Alarm	Minor Fault	Major Fault	
SF09	Guard Stop Input Fault	X	X	-	-	-	X	Disable/Coast

## Web Server Interface

The Kinetix 5300 drive supports a basic web server interface for drive diagnostics and fault information. The webpages are read-only, so no attributes are configurable.

Follow these steps to access the webpages.

1. Open your web browser.
2. In the Address field, type the IP address of the drive.
3. Press Enter.

**IMPORTANT** The webpage server is turned off by default. To access the webpages, the web server must be enabled on the device. To enable the web server, see the [Table 58 on page 101](#) and [Figure 56 on page 102](#).

To access the diagnostic or fault webpages, open the corresponding folder in the left-most navigation bar, and click the link for each webpage you must monitor. The web server contains the following webpages.

**Table 80 - Web Server Interface Categories**

Main Categories	Sub Categories	Description
Home		Provides basic device information.
Diagnostics	Drive Information	Provides device power cycling and uptime-related information.
	Motor Diagnostics	Provides information about the connected motor.
	Encoder Diagnostics	Provides encoder-related information for all connected motors.
	Network Settings	Provides network-related information.
	Ethernet Statistics	Provides Ethernet related information.
	Network Statistics	Provides network statistics-related information.
	Monitor Signals	Provides real-time attribute information.
Fault Log		Displays major and minor fault information.

Examples of each webpage are shown in the following figures.

**Figure 60 - Home**

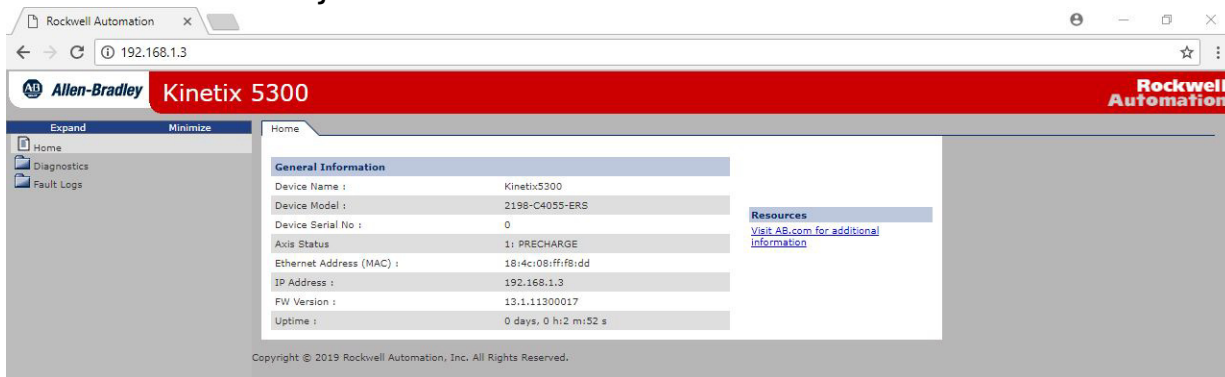

Figure 61 - Drive Information

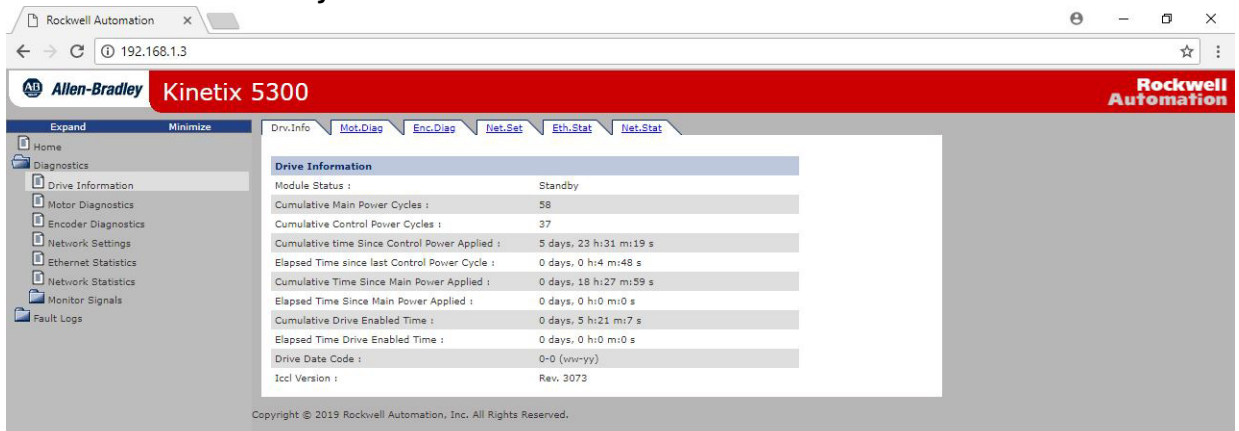

Figure 62 - Motor Information

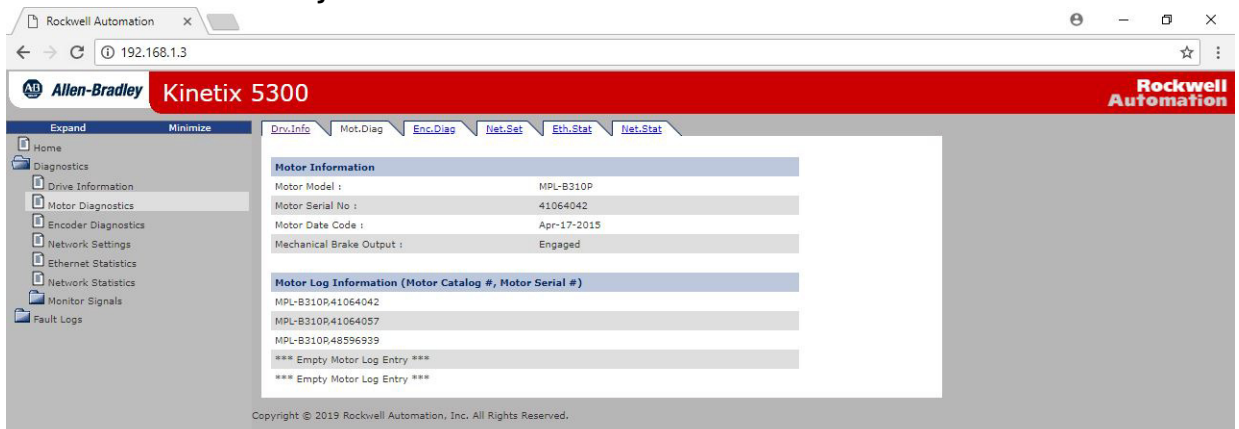

Figure 63 - Encoder Diagnostics

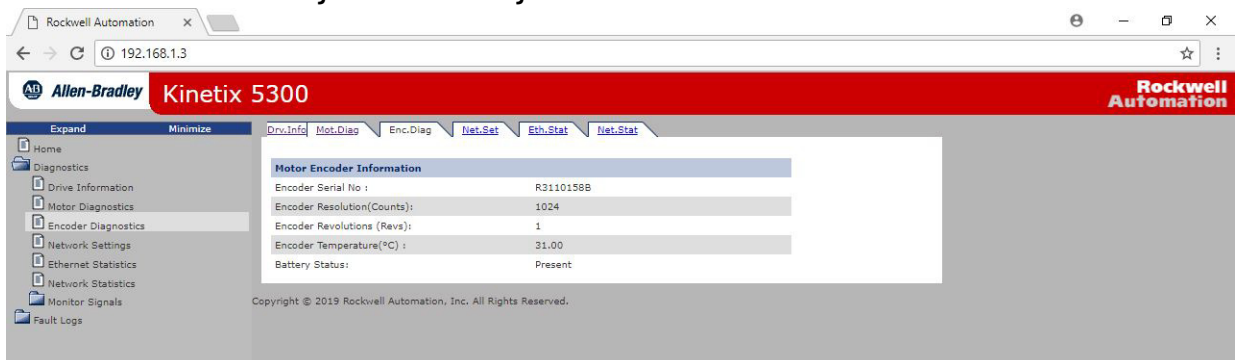

Figure 64 - Network Settings

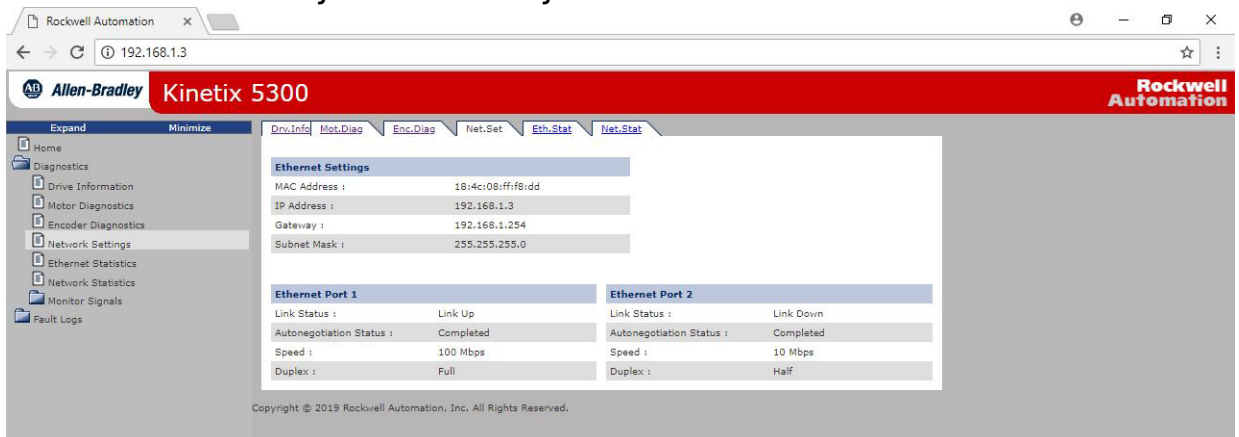

Figure 65 - Ethernet Statistics

The screenshot displays the Ethernet Statistics page for the Kinetix 5300 drive. The interface includes a navigation menu on the left and a main content area with the following data:

Ethernet Port 1		Ethernet Port 2	
Enabled :	Yes	Enabled :	Yes
Speed :	100 Mbps	Speed :	10 Mbps
Duplex :	Full Duplex	Duplex :	Half Duplex
Autonegotiation Status :	Autonegotiation completed	Autonegotiation Status :	Autonegotiation completed

Media Counters Port 1		Media Counters Port 2	
Alignment Errors :	0	Alignment Errors :	0
FCS Errors :	0	FCS Errors :	0
Single Collisions :	0	Single Collisions :	0
Multiple Collisions :	0	Multiple Collisions :	0
Excessive Collisions :	0	Excessive Collisions :	0
Frame Too Long :	0	Frame Too Long :	0

Interface Counters Port 1		Interface Counters Port 2	
In Octets :	35787888	In Octets :	0
In Unicast Packets :	6101	In Unicast Packets :	0
In Non-Unicast Packets :	2046	In Non-Unicast Packets :	0
In Errors :	0	In Errors :	0
Out Octets :	36065761	Out Octets :	231253
Out Unicast Packets :	5841	Out Unicast Packets :	0
Out Non-Unicast Packets :	47	Out Non-Unicast Packets :	2107
Out Errors :	0	Out Errors :	1

Copyright © 2019 Rockwell Automation, Inc. All Rights Reserved.

Figure 66 - Monitor Signals - Full Axis

The screenshot displays the Monitor Signals - Full Axis page. The interface shows the following data:

Motion Attributes		Temperature Attributes	
Axis State:	Pre-charge	Converter Temperature(°C):	28.59
Position Command(Counts):	0	Converter Capacity(% Conv rated):	0.00
Motor Position(Counts):	-248569	Inverter Temperature(°C):	28.59
Load Position(Counts):	0	Inverter Capacity(% Inv rated):	0.00
Velocity Command (Revs/s):	0.00	Motor Temperature(°C):	0.00
Motor Velocity (Revs/s):	-0.00	Motor Capacity(% Motor Rated):	0.19
Load Velocity (Revs/s):	0.00	Encoder Temperature(°C):	31.00
Current Command(%Motor rated):	0.00	Bus Regulator Capacity(% Regulator Rated):	0.00
Current Feedback(%Motor rated):	0.54		
Output Current(Amps-rms):	0.00	Digital Inputs	
Output Voltage(Volts-rms):	0.00	Input1:	OFF
Output Frequency(Hz):	0.12	Input2:	OFF
Energy Usage(Kv·h):	0.00000	Input3:	OFF
Bus Voltage(Volts):	0.00	Input4:	OFF
		Safety Inputs	
		Input1:	ON
		Input2:	ON

Copyright © 2019 Rockwell Automation, Inc. All Rights Reserved.

Figure 67 - Monitor Signals - Auxiliary Axis

The screenshot displays the Monitor Signals - Auxiliary Axis page. The interface shows the following data:

Motion Attributes	
Axis State:	Not configured
Position Feedback(Counts):	Not configured
Velocity Feedback:	Not configured

Copyright © 2019 Rockwell Automation, Inc. All Rights Reserved.



Figure 68 - Fault Logs

The screenshot shows the Rockwell Automation Kinetix 5300 web interface. The browser address bar shows '192.168.1.3'. The page title is 'Kinetix 5300'. On the left, there is a navigation menu with options like Home, Diagnostics, Drive Information, Motor Diagnostics, Encoder Diagnostics, Network Settings, Ethernet Statistics, Network Statistics, Monitor Signals, Full Axis, Feedback Only Axis, Fault Logs, and Fault Log. The main content area displays a 'Fault Log (Most Recent on Top) (Real Time)' table with 10 entries. Each entry includes a sequence number, a timestamp (CipTime(GMT)), uptime, cumulative uptime, fault ID, fault subcode, and a description of the fault.

Sequence	CipTime(GMT)	Uptime	CumulativeUptime	FaultId	FaultSubCode	Description
1.	Thu Jan 1 00:56:33 1970	0 days, 0 h:19 m:47 s	5 days, 23 h:46 m:18 s	46	1	1: FLT S46 - FDBK COMM UL 1
2.	Thu Jan 1 00:56:33 1970	0 days, 0 h:19 m:47 s	5 days, 23 h:46 m:18 s	45	1	1: FLT S45 - FDBK COMM FL 1
3.	Thu Jan 1 00:56:33 1970	0 days, 0 h:19 m:47 s	5 days, 23 h:46 m:18 s	44	1	1: FLT S44 - FDBK LOSS UL 1
4.	Thu Jan 1 00:56:33 1970	0 days, 0 h:19 m:47 s	5 days, 23 h:46 m:18 s	43	1	1: FLT S43 - FDBK LOSS FL 1
5.	Sun Jan 4 00:13:01 1970	3 days, 0 h:12 m:42 s	4 days, 20 h:34 m:25 s	1	1	NODE FLT 01 - LATE CTRL UPDATE
6.	Sun Jan 4 00:11:59 1970	3 days, 0 h:11 m:41 s	4 days, 20 h:33 m:24 s	1	1	NODE FLT 01 - LATE CTRL UPDATE
7.	Thu Jan 1 07:15:08 1970	0 days, 7 h:14 m:51 s	2 days, 3 h:36 m:34 s	8	0	1: FLT S08 - MTR OVERLOAD UL
8.	Thu Jan 1 07:15:08 1970	0 days, 7 h:14 m:51 s	2 days, 3 h:36 m:34 s	7	0	1: FLT S07 - MTR OVERLOAD FL
9.	Thu Jan 1 07:12:09 1970	0 days, 7 h:11 m:52 s	2 days, 3 h:33 m:35 s	1	0	NODE FLT 01 - LATE CTRL UPDATE
10.	Thu Jan 1 06:50:51 1970	0 days, 6 h:50 m:33 s	2 days, 3 h:12 m:16 s	7	0	1: FLT S07 - MTR OVERLOAD FL

**Notes:**

## Remove and Replace Servo Drives

This chapter applies to Kinetix® 5300 drive systems where the zero-stack mounting feature is used and it becomes necessary to replace one of the drives without affecting the others.

Topic	Page
Before You Begin	155
Remove and Replace Kinetix 5300 Servo Drives	156
Start and Configure the Drive	158



**ATTENTION:** This drive contains electrostatic discharge (ESD) sensitive parts and assemblies. You are required to follow static-control precautions when you install, test, service, or repair this assembly. If you do not follow ESD control procedures, components can be damaged. If you are not familiar with static control procedures, refer to Guarding Against Electrostatic Damage, publication [8000-4.5.2](#), or any other applicable ESD awareness handbook.

### Before You Begin

When each drive is installed, network settings are configured from the setup screens. Before removing the drive, revisit the Network menu and make note of the static IP or DHCP settings. To access those settings, see [Configure the Kinetix 5300 Drive on page 105](#).

**IMPORTANT** If you intend to use the same Logix Designer application after replacing your drive, the new drive must be the same catalog number as the old drive.

You also need these tools available before you begin removal and replacement procedures:

- Screwdrivers (to loosen/remove screws)
- Voltmeter (to make sure that no voltage exists on drive connectors)

## Remove and Replace Kinetix 5300 Servo Drives

Follow these steps to remove and replace servo drives from the panel.

### Remove Power and All Connections

1. Verify that all control and input power has been removed from the system.



**ATTENTION:** To avoid shock hazard or personal injury, make sure that all power has been removed before proceeding. This system can have multiple sources of power. Multiple disconnect switches can be required to de-energize the system.

2. Wait 5 minutes for the DC bus to discharge completely before proceeding.



**SHOCK HAZARD:** This product contains stored energy devices. To avoid the hazard of electrical shock, verify that the voltage on capacitors has been discharged before attempting to service, repair, or remove this unit. Do not attempt the procedures in this document unless you are qualified to do so and are familiar with solid-state control equipment and the safety procedures in publication NFPA 70E.

3. Label and remove all wiring connectors from the drive that you are removing. To identify each connector, see [Kinetix 5300 Connector Data on page 52](#).



You do not need to remove the shunt connector, unless there is an external shunt that is wired to it.

4. If used, remove the 24V shared-bus input wiring connector, T-connector, and busbar from the drive you are removing. See [Shared-bus Connection System on page 43](#).
5. Use a screwdriver to loosen or remove the two cable clamp screws, as needed.

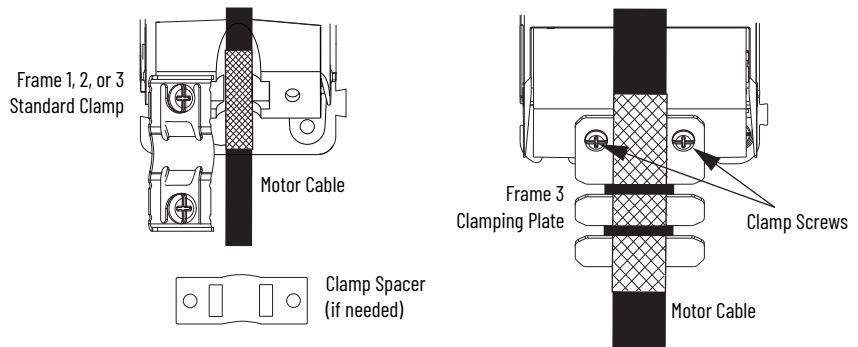

All drives are equipped with a standard clamp. Remove one or both screws as needed. However, for the Frame 3 clamping plate, remove both screws and transfer the clamping plate to the new Frame 3 drive.

6. Remove the motor power cable from the cable shield clamp.
7. Unplug the motor feedback cable connector or 2198-K53CK-D15M connector kit from the MFB connector.
8. Remove the ground screw and braided ground strap.

See [Ground the System Subpanel on page 71](#).

## Remove the Servo Drive

You can remove single-axis drives from the panel or any single drive from a zero-stack configuration by using the same procedure.

---

**IMPORTANT** This procedure applies to any 2198-Cxxx-ERS drive in any configuration.

---

Follow these steps to remove Kinetix 5300 servo drives from the panel.

1. Loosen the top and bottom screws of the drive to remove.  
Frame 1 and 2 drives have one top and one bottom screw. Frame 3 drives have two top and two bottom screws.
2. Grasp the top and bottom of the drive with both hands and pull the drive straight out and away from the panel, clearing the zero-stack mounting tabs and cutouts.

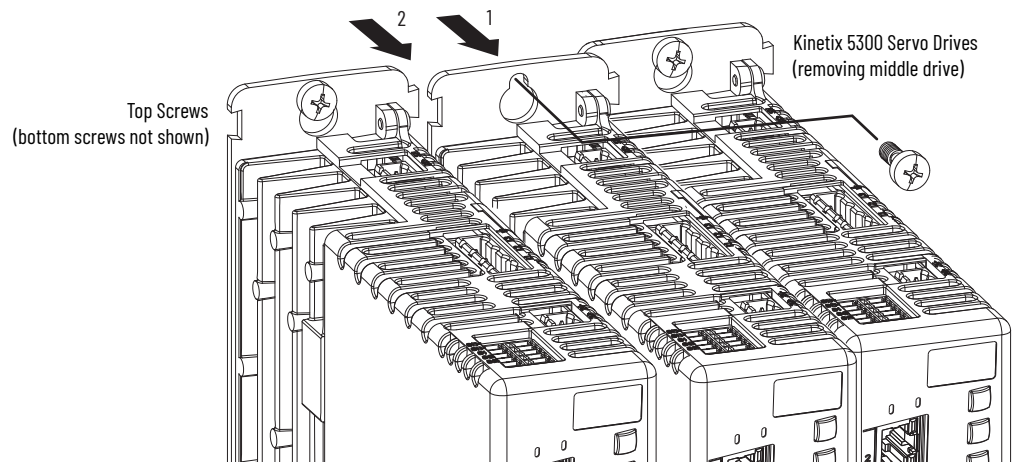

## Replace the Servo Drive

To replace the servo drive, perform the steps in [Remove the Servo Drive](#) in reverse or see [Mount Your Kinetix 5300 Drive on page 50](#):

- Torque mounting, shield clamp, and ground screws to 2.0 N•m (17.7 lb•in), max
- Reconnect the feedback connector kit and torque the mounting screws to 0.4 N•m (3.5 lb•in), max

## Start and Configure the Drive

Follow these steps to configure the replacement drive.

---

**IMPORTANT** If you intend to use the same Logix Designer application after replacing your drive, the new drive must be the same catalog number as the old drive.

---

1. Reapply power to the drive/system.  
For the procedure, refer to [Apply Power to the Kinetix 5300 Drive on page 137](#).
2. Configure the network settings for the drive.  
If your old drive was configured as Static IP, you must set the IP address, gateway, and subnet mask in the new drive identical to the old drive.  
To access those settings, refer to [Configure the Kinetix 5300 Drive on page 105](#).
3. Download the Logix Designer application to the controller.
4. Verify the drive/system is working properly.

## Kinetix 5300 Safe Torque Off Function

The Kinetix® 5300 servo drives support the hardwired Safe Torque Off (STO) function as defined by IEC 61800-5-2. The hardwired STO function meets the requirements of Performance Level d (PLd) and Category 3 (CAT 3) per ISO 13849-1, and SIL CL2 per IEC 61508, EN/IEC 61800-5-2, and EN/IEC 62061.

Topic	Page
Certification	159
Description of Operation	160
Probability of Dangerous Failure Per Hour	164
Safe Torque Off Connector Data	164
Wire the Safe Torque Off Circuit	165
Safe Torque Off Feature	166
Safe Torque Off Specifications	168

The 2198-Cxxxx-ERS servo drives use the STO connector for wiring external safety devices and cascading hardwired safety connections from one drive to another.

### Certification

The TÜV Rheinland group has approved 2198-Cxxxx-ERS servo drives with hardwired STO for use in safety-related applications up to ISO 13849-1, Performance Level d (PLd) and Category 3, SIL CL 2 per IEC 61508, EN/IEC 61800-5-2, and EN/IEC 62061, in which removing the motion-producing power is considered to be the safe state.

For product certifications currently available from Rockwell Automation, go to website [rok.auto/certifications](http://rok.auto/certifications).

### Important Safety Considerations

You, the system user, are responsible for the following:

- Validation of any sensors or actuators that are connected to the system
- Completing a machine-level risk assessment
- Certification of the machine to the desired ISO 13849-1 Performance Level or EN/IEC 62061 SIL level
- Project management and proof testing in accordance with ISO 13849-1

## Category 3 Requirements According to ISO 13849-1

Safety-related parts are designed with these attributes:

- A single fault in any of these parts does not lead to the loss of the safety function.
- A single fault is detected whenever reasonably practicable.
- Accumulation of undetected faults can lead to the loss of the safety function and a failure to remove motion-producing power from the motor.

### Stop Category Definition

Stop Category 0 as defined in EN/IEC 60204-1 or Safe Torque Off as defined by EN/IEC 61800-5-2 is achieved with immediate removal of motion-producing power to the actuator.

---

**IMPORTANT** If there is a malfunction, the most likely stop category is Stop Category 0. When designing the machine application, timing and distance must be considered for a coast-to-stop. For more information regarding stop categories, see EN/IEC 60204-1.

---

### Performance Level (PL) and Safety Integrity Level (SIL)

For safety-related control systems, Performance Level (PL), according to ISO 13849-1, and SIL levels, according to IEC 61508 and EN/IEC 62061, include a rating of the systems ability to perform its safety functions. All safety-related components of the control system must be included in both a risk assessment and the determination of the achieved levels.

See the ISO 13849-1, IEC 61508, and EN/IEC 62061 standards for complete information on requirements for PL and SIL determination.

## Description of Operation

The Safe Torque Off (STO) feature provides a method, with sufficiently low probability of failure, to force the power-transistor control signals to a disabled state. When disabled, or any time power is removed from the STO inputs, all drive output-power transistors are released from the ON-state. This release from the ON-state results in a condition where the drive performs a Category 0 Stop.



**ATTENTION:** Disabling the power transistor output does not provide mechanical isolation of the electrical output that is required for some applications.

---

Under normal operation, the STO inputs are energized. If either of the STO inputs are de-energized, then all output power transistors turn off. The Safe Torque Off response time is less than 12 ms.



Figure 69 - Normal System Operation

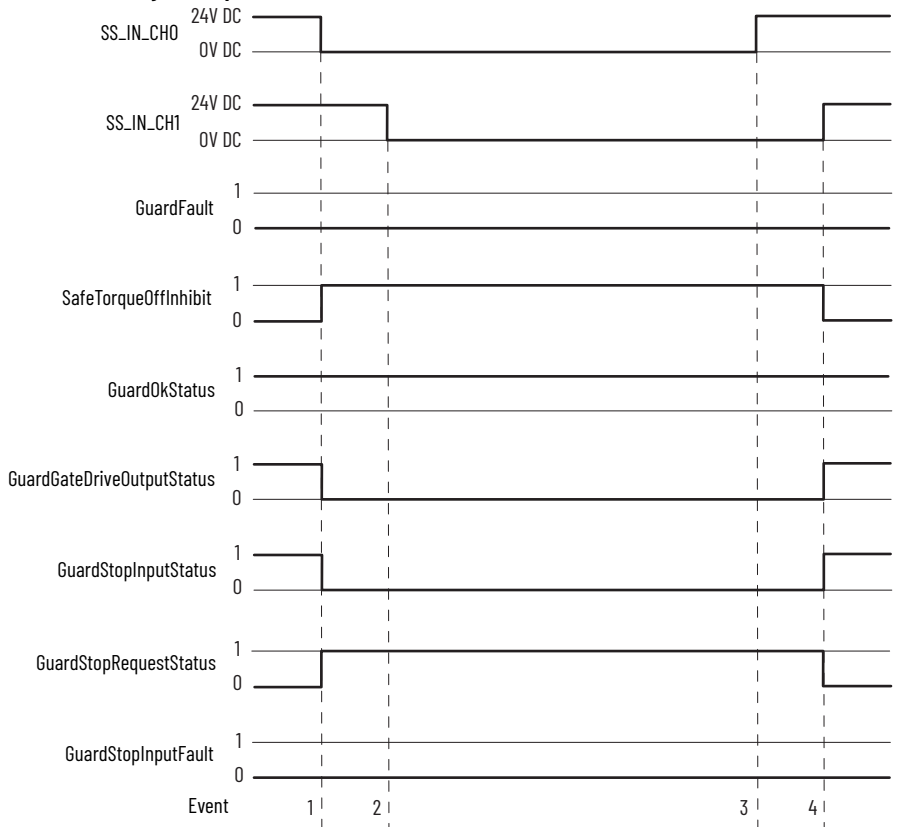

All status attributes in Figure 69 are for status purposes only and should not be used as a condition for motion.

Table 81 - Normal System Operation Legend

Event	Description
1	SS_IN_CHO is removed. <ul style="list-style-type: none"> <li>GuardGateDriveOutputStatus, GuardOkStatus, and GuardStopInputStatus = 1</li> <li>SafeTorqueOffInhibit, GuardFault, GuardStopRequestStatus, and GuardStopInputFault = 0</li> </ul>
2	SS_IN_CH1 is removed < 1 second
3	SS_IN_CHO is reapplied
4	SS_IN_CH1 is reapplied < 1 second of S1 or Event 3 <ul style="list-style-type: none"> <li>SafeTorqueOffInhibit, GuardOkStatus, and GuardStopRequestStatus = 1</li> <li>GuardFault, GuardGateDriveOutputStatus, GuardStopInputStatus, and GuardStopInputFault = 0</li> </ul>



**ATTENTION:** If there are two simultaneous faults in the IGBT circuit, permanent magnet motors can result in a rotation of up to 180 electrical degrees.

**IMPORTANT** If any of the STO inputs are de-energized, the Start Inhibit field indicates SafeTorqueOffInhibit and GuardStopRequestStatus bit of AxisGuardStatus tag set to 1.

## Fault Codes



This manual links to Kinetix 5300 Single-axis EtherNet/IP Servo Drives Fault Codes Reference Data, publication [2198-RD006](#), for fault codes. Download the spreadsheet now for offline access.

Both redundant STO input signals are expected to always be in the same state and transition from one state to another simultaneously.

**IMPORTANT** If both STO inputs are not in the OFF state simultaneously within 100 ms or after 1 second, GuardStopInputFault is posted.

If a fault condition is detected, the motion-producing power can be applied to the motor only after fault reset conditions are satisfied.

**IMPORTANT** GuardStopInputFault can be reset only if both inputs are in the OFF-state for more than 1 second. After the fault reset requirement is satisfied, an MAFR command in the Logix Designer application must be issued to reset GuardStopInputFault.

**IMPORTANT** GuardStopInputFault active state shall not be used as an indication of STO state. Only deactivation of SS\_IN\_CHO and SS\_IN\_CH1 inputs provides STO function with integrity. For GuardStopInputFault behavior description, see [Table 79 on page 149](#).

[Figure 70](#) demonstrates when the Safe Torque Off discrepancy is detected and a GuardStopInputFault is posted.

**Figure 70 - System Operation in the Event of STO Inputs Discrepancy (fault case 1)**

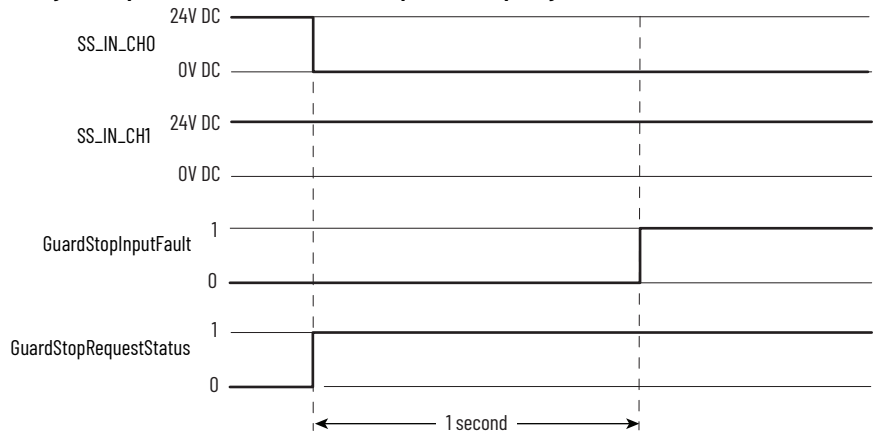

**Figure 71 - System Operation in the Event of STO Inputs Discrepancy (fault case 2)**

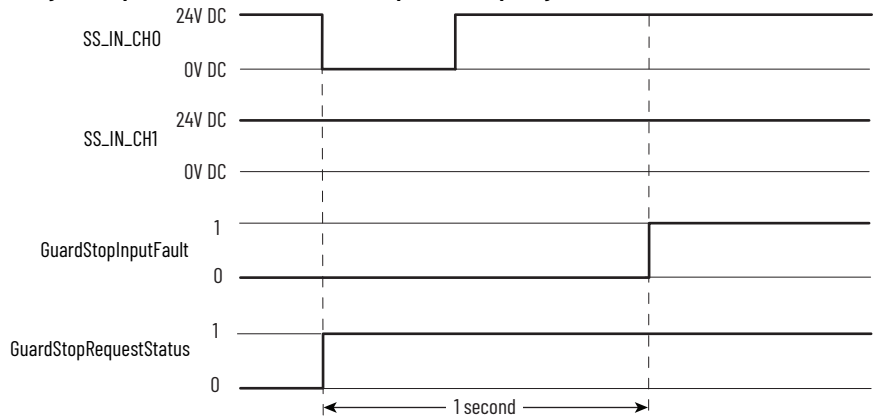

**Figure 72 - System Operation in the Event of STO Inputs Discrepancy (fault case 3)**

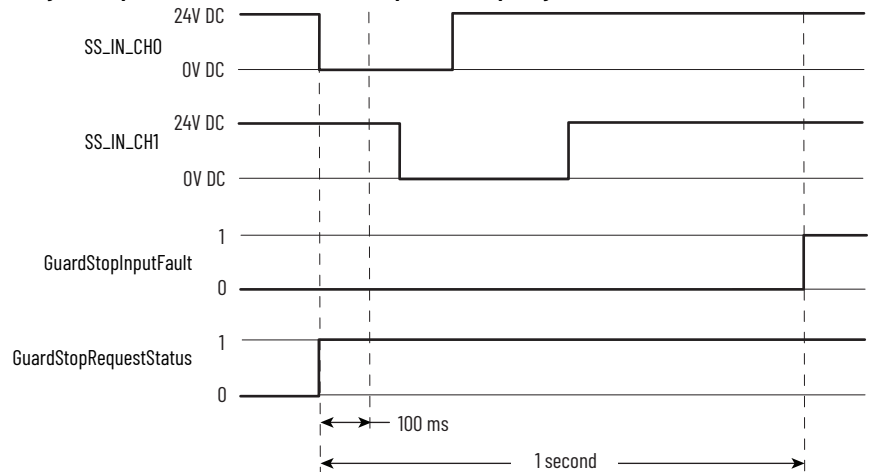

**ATTENTION:** The Safe Torque Off (STO) fault is detected upon demand of the STO function. After troubleshooting the STO function or performing maintenance that might affect the STO function, the STO function must be executed to verify correct operation. See [Table 82](#) for troubleshooting information.

**Table 82 - Troubleshoot Hardwired STO Function**

Safe Torque Off Function Input Discrepancy	Corrective Action
System does not allow motion. Safe Torque Off input discrepancy is detected when safety inputs are in a different state for more than 1.0 second.	<ul style="list-style-type: none"> <li>Verify safety wiring and connections:                             <ul style="list-style-type: none"> <li>Wire terminations at Safe Torque Off (STO) connector</li> <li>Cable/header not seated correctly</li> <li>+24V power within specified limits</li> </ul> </li> <li>Check state of safety inputs.</li> <li>Reset error and execute the STO function to verify that the function operates properly.</li> <li>If the error persists, remove the drive from service immediately and return to Rockwell Automation.</li> </ul>

## Probability of Dangerous Failure Per Hour

Safety-related systems are classified as operating in a High-demand/continuous mode. The SIL value for a High-demand/continuous mode safety-related system is directly related to the probability of a dangerous failure occurring per hour (PFH).

The PFH calculation is based on the equations from IEC 61508, and shows worst-case values. [Table 83](#) provides data for a 20-year proof test interval and demonstrates the worst-case effect of various configuration changes on the data.



**ATTENTION:** Determination of the safety parameters is based on the assumptions that the system operates in High-demand mode and that to maintain the integrity of the STO function it must be executed at least once per year.

**Table 83 - Safety Relevant Parameters**

Attribute	Value
Hardware Fault Tolerance (HFT)	1
Mode of operation	High-demand/continuous
STO function components type according to IEC 61508-2	Type A
PFH (1e-9/hour)	0.021
MTTFd	400,000 years
Proof test interval <sup>(1)</sup>	20 years
Diagnostic Coverage (DC)	92%

(1) No proof-test-related maintenance is required within 20 years mission time.

## Safe Torque Off Connector Data

The 10-pin connector consists of two parallel 5-pin rows for cascading safety connections from drive-to-drive when drives are joined by the zero-stack feature.

**Figure 73 - Pin Orientation for 10-pin Safe Torque Off (STO) Connector**

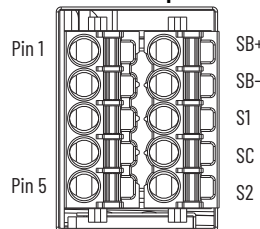

**Table 84 - Safe Torque Off Connector Pinouts**

STO Pin	Description	Signal
1/6	Safety bypass plus signal. Connect to both safety inputs to disable the STO function.	SB+
2/7	Safety bypass minus signal. Connect to safety common to disable the STO function.	SB-
3/8	STO input 1 (SS_IN_CHO).	S1
4/9	STO input common (SCOM).	SC
5/10	STO input 2 (SS_IN_CH1).	S2

## Wire the Safe Torque Off Circuit

This section provides guidelines for wiring your Kinetix 5300 Safe Torque Off (STO) drive connections.

**IMPORTANT** The National Electrical Code and local electrical codes take precedence over the values and methods provided.

**IMPORTANT** To improve system performance, run wires and cables in the wireways as established in [Establish Noise Zones on page 37](#).

**IMPORTANT** Pins SB+ and SB- are used to disable the STO function. When wiring to the STO connector, use an external 24V supply for the external safety device that triggers the STO request. To avoid jeopardizing system performance, do not use pin SB+ as a power supply for the external safety device.

### Safe Torque Off Wiring Requirements

The STO connector uses spring tension to secure the wire. Depress the tab, along side each pin, to insert or release the wire. Two rows of pins are provided for drive-to-drive connections. Wire must be copper with 75 °C (167 °F) minimum rating.

**IMPORTANT** Stranded wires must terminate with ferrules to help prevent short circuits, per table D7 of ISO 13849-1.

Figure 74 - STO Terminal Plug

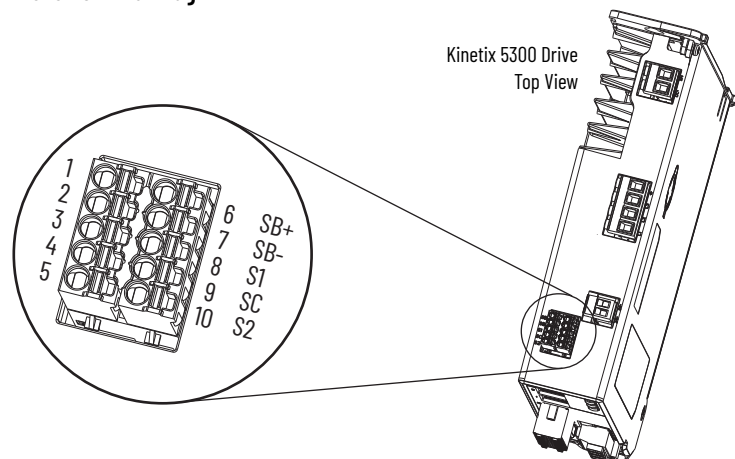

Table 85 - STO Terminal Plug Wiring

STO Connector		Recommended Wire Size mm <sup>2</sup> (AWG)	Strip Length mm (in.)	Torque Value N•m (lb•in)
Pin	Signal			
STO-1/6	SB+	0.2...1.5 (24...16)	10 (0.39)	_(1)
STO-2/7	SB-			
STO-3/8	S1			
STO-4/9	SC			
STO-5/10	S2			

(1) This connector uses spring tension to hold the wires in place.

## Safe Torque Off Feature

The Safe Torque Off (STO) circuit, when used with suitable safety components, provides protection according to ISO 13849-1 (PLd), Category 3 or according to IEC 61508, EN/IEC 61800-5-2, and EN/IEC 62061 (SIL CL2). All components in the system must be chosen and applied correctly to achieve the desired level of operator safeguarding.

The STO circuit is designed to safely turn off all output-power transistors. You can use the STO circuit in combination with other safety devices to achieve Stop Category 0 and protection-against-restart as specified in EN/IEC 60204-1.



**ATTENTION:** This option is suitable only for performing mechanical work on the drive system or affected area of a machine. It does not provide electrical safety.



**ATTENTION:** If the STO function is requested and results in torque-producing power being removed, some applications can require additional safety measures to help prevent hazardous motion.



**SHOCK HAZARD:** In STO mode, hazardous voltages can still be present at the drive. To avoid an electric shock hazard, disconnect power to the system and verify that the voltage is zero before performing any work on the drive.



**ATTENTION:** Personnel responsible for the application of safety-related programmable electronic systems (PES) shall be aware of the safety requirements in the application of the system and shall be trained in using the system.

## Safe Torque Off Feature Bypass

The 2198-Cxxxx-ERS drives do not operate without a safety circuit or safety bypass wiring. For applications that do not require the STO feature, you must install jumper wires to bypass the STO circuitry.

Each 2198-Cxxxx-ERS drive includes one 10-pin wiring plug for wiring to safety devices. To bypass the safety function, wire these signals as shown in [Figure 75](#). With the jumper wires installed, the Safe Torque Off feature is not used.

Figure 75 - Safe Torque Off Bypass Wiring

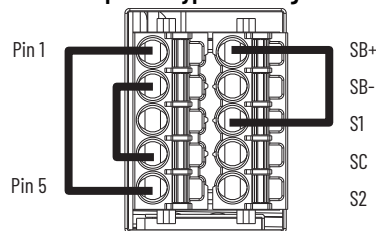

### Cascade the Safe Torque-off Signal

The total number of drives in a single cascaded safety circuit is limited by the current carrying capacity of the cascaded safety wiring and dual-channel equivalent safety-device contact rating. See [Table 86](#) on [page 168](#) for current rating per channel, per drive.

Figure 76 - Cascaded Safe Torque Off Wiring

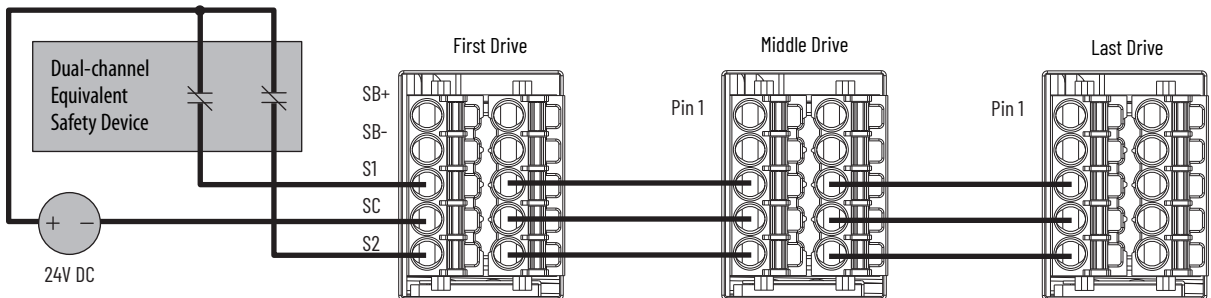

### STO Recovery Time

If the STO inputs discrepancy time is <100 ms, the drive permits torque in 100 ms from the first detected input transition to the ON state.

Figure 77 - STO Recovery Time With Short STO Inputs Discrepancy

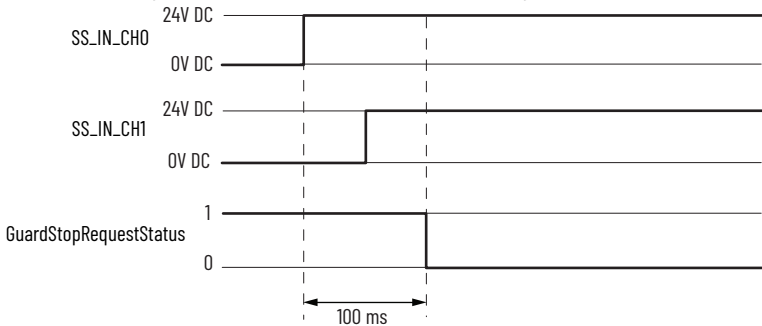

If the STO inputs discrepancy time is >100 ms, but <1.0 s, the drive permits torque after 1.0 s from the first detected input transition to the ON state.

Figure 78 - STO Recovery Time With Long STO Inputs Discrepancy

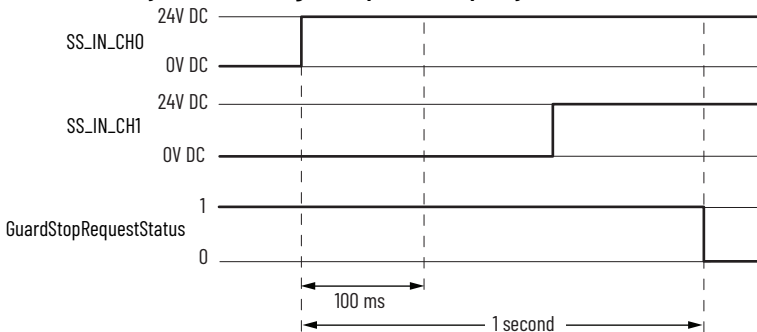

**ATTENTION:** If both inputs are not in the ON state after 1 second, GuardStopInputFault is posted.

## Safe Torque Off Specifications

To maintain the safety rating, Kinetix 5300 drives must be installed inside protected control panels or cabinets appropriate for the environmental conditions of the industrial location.

**IMPORTANT** The protection class of the panel or cabinet must be IP54 or higher.

**Table 86 - Safe Torque Off Signal Specifications**

Attribute		Value
Safety inputs (per channel)	Input current (typical)	2.5 mA
	Input ON voltage range (typical)	15...26.4V DC
	Input OFF voltage, max	5V DC
	Digital input type according to IEC 61131-2	24V DC Type 1
	External power supply	24V DC $\pm$ 10% PELV
	Input protection	Optically isolated, reverse voltage protected
	OSSD short circuit test pulse width, max	700 $\mu$ s
	OSSD short circuit test pulse interval, min	100 ms
	STO response time	12 ms
	STO recovery time	100 ms or 1 s fixed (refer to <a href="#">Figure 77</a> and <a href="#">Figure 78</a> )

For additional information regarding Allen-Bradley® safety products, including safety relays, light curtain, and gate interlock applications, see <https://www.rockwellautomation.com/en-us/products/hardware/allen-bradley/safety-products.html>.



## Interconnect Diagrams

This appendix provides wiring examples and system block diagrams for your Kinetix<sup>®</sup> 5300 system components.

Topic	Page
Interconnect Diagram Notes	169
Power Wiring Examples	170
Shunt Resistor Wiring Example	172
Kinetix 5300 Servo Drive and Rotary Motor Wiring Examples	173
Kinetix 5300 Drive and Linear Actuator Wiring Examples	179
System Block Diagrams	184

## Interconnect Diagram Notes

This appendix provides wiring examples to assist you in wiring the Kinetix 5300 drive system. These notes apply to the wiring examples on the pages that follow.

Table 87 - Interconnect Diagram Notes

Note	Information
1	For power wiring specifications, refer to <a href="#">Wiring Requirements on page 73</a> .
2	For input fuse and circuit breaker sizes, refer to <a href="#">Circuit Breaker/Fuse Selection on page 27</a> .
3	AC (EMC) line filter is required for EMC compliance. Mount the line filter with 50 mm (1.97 in.) minimum clearance between the drive and filter. Minimize the cable length as much as possible and do not route very dirty wires in the wireway. If routing in the wireway is unavoidable, use shielded cable with shields that are grounded to the drive chassis and filter case. For AC line filter specifications, refer to Kinetix 5700, 5500, 5300, and 5100 Servo Drives Specifications Technical Data, publication <a href="#">KNX-TD003</a> . Drives are limited to one power cycle per minute.
4	Terminal block is required to make connections.
5	Cable shield clamp must be used to meet CE and UK requirements.
6	PE ground connection bonded to the panel must be used to meet CE and UK requirements.
7	Internal shunt wired to the shunt connector is the default configuration. Unplug the internal shunt connector and connect the external shunt wires to the spare shunt connector plug.
8	For motor cable specifications, refer to Kinetix Rotary and Linear Motion Cable Specifications Technical Data, publication <a href="#">KNX-TD004</a> .
9	MPL-A/B15xx-H...MPL-A/B45xx-H, MPL-A15xx-V/E...MPL-A2xx-V/E, MPL-A3xx-S/M...MPL-A45xx-S/M, MPM-A115xx...MPM-A130xx, MPF-A3xx...MPF-A45xx, MPS-Axxx, MPAR-Axxx, MPAS-Axxx, and MPAS-Bxxx (direct-drive) encoders use the +5V DC supply.
10	MPL-B15xx-V/E...MPL-B2xx-V/E, MPL-B3xx-S/M...MPL-B6xx-S/M, MPL-A5xx, MPM-Bxx, MPM-A165xx...MPM-A215xx, MPF-Bxx, MPF-A5xx, MPS-Bxxx, MPAR-Bxxx, and MPAS-Bxxx (ballscrew) encoders use the +9V DC supply.
11	Kinetix LDAT linear thrusters, Kinetix MPAS (direct-drive) linear stages, and Kinetix LDC/Kinetix LDL linear motors do not include a brake option, so only the 2090-CPWM7DF-xxAAxx or 2090-CPWM7DF-xxAFxx motor power cables are specified.

# Power Wiring Examples

You must supply input power components. The single-phase and three-phase line filters are wired downstream of the circuit protection.

Figure 79 - Kinetix 5300 Drives Power Wiring (three-phase operation)

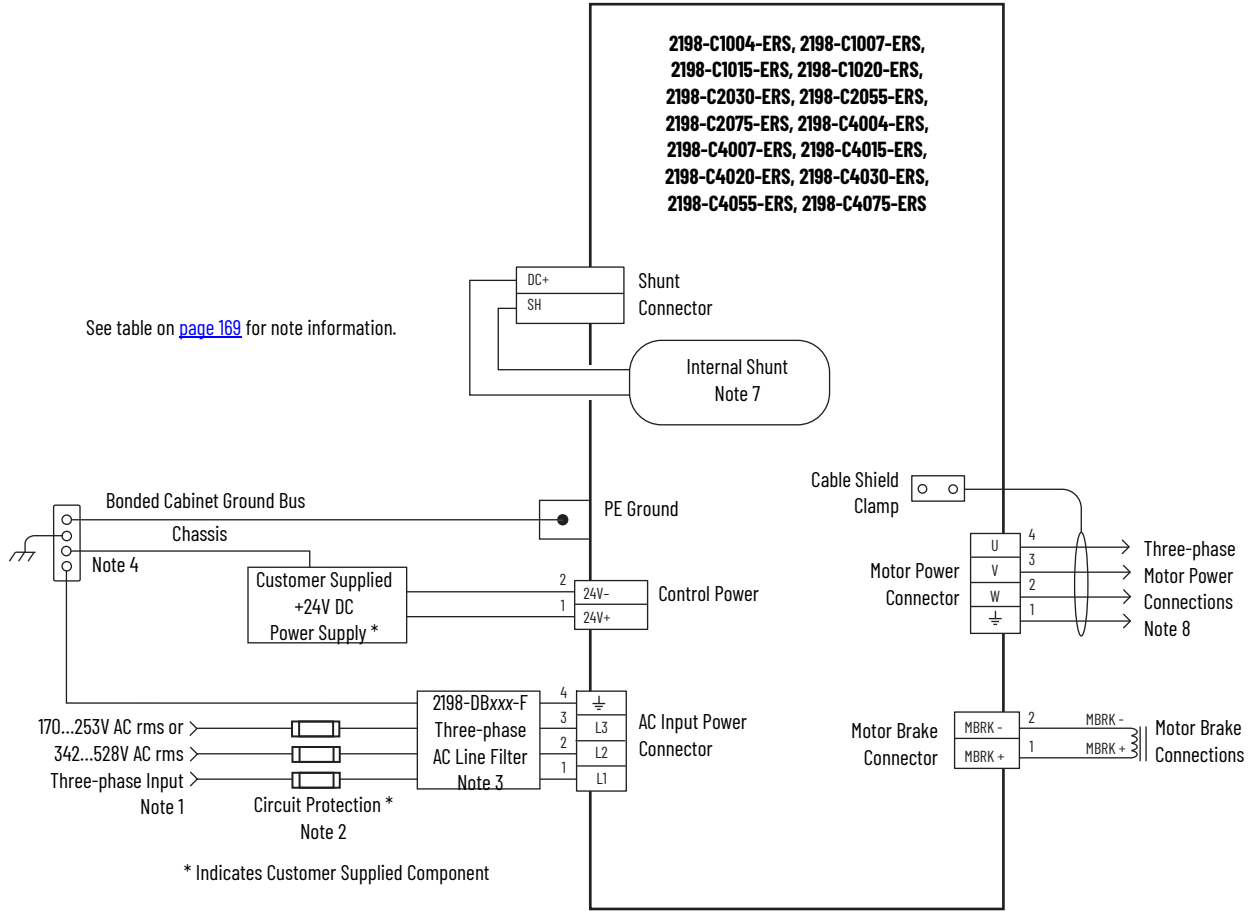
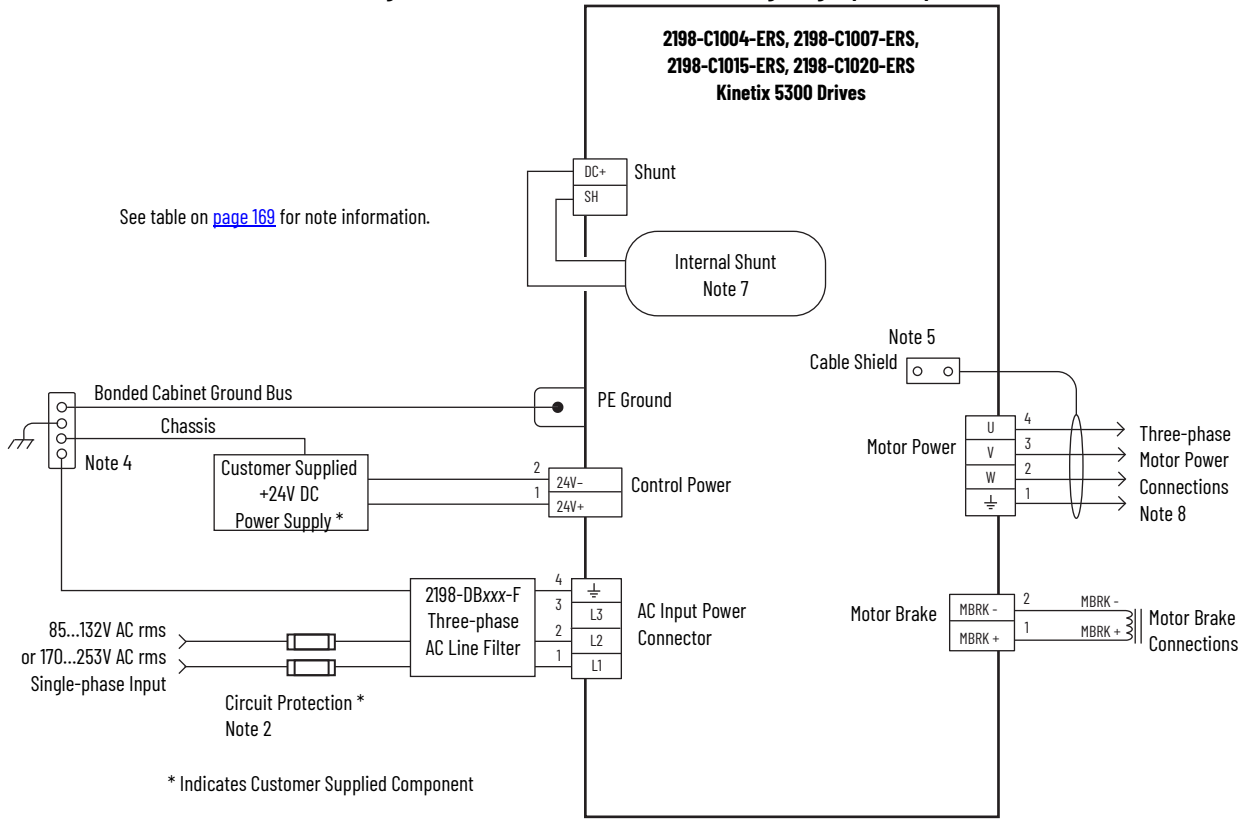

Figure 80 - Kinetix 5300 Drives Power Wiring (single-phase operation)



## Shunt Resistor Wiring Example

Bulletin 2198-Rxxx shunts and 2097-Rx shunt resistors are available for Kinetix 5300 drives.

- For shunt specifications, see Kinetix 5700, 5500, 5300, and 5100 Servo Drives Specifications Technical Data, publication [KNX-TD003](#).
- For specifications specific to your Kinetix 5300 drive application, see [Passive Shunt Considerations on page 30](#).
- When installing Bulletin 2097 shunts, see the Bulletin 2097 Shunt Resistor Installation Instructions, publication [2097-IN002](#).
- When installing Bulletin 2198 shunts, see Kinetix 5700 Passive Shunt Modules Installation Instructions, publication [2198-IN011](#).

---

**IMPORTANT** A spare 2-pin shunt-connector plug is included with each drive for use with an external shunt. Unplug the internal shunt connector and connect the external shunt wires to the spare shunt-connector plug.

---

Figure 81 - External Shunt Resistor Wiring Example

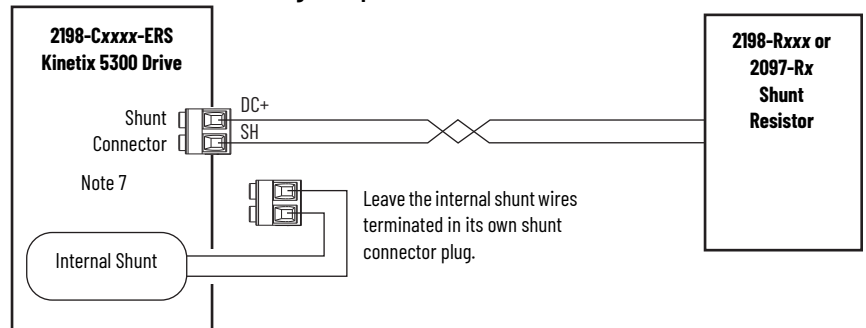

# Kinetix 5300 Servo Drive and Rotary Motor Wiring Examples

These wiring diagrams apply to Kinetix 5300 drives with compatible Allen-Bradley® rotary motors.

In this example, the Kinetix TLP compact motor with rectangular connectors uses a power/brake cable. Flying-lead feedback connections to the 2198-K53CK-D15M feedback connector kit are made by using bulk cable and building your own cables. See Build Your Own Kinetix TLP Motor Cables Installation Instructions, publication [2090-IN048](#), for more information.

Figure 82 - Kinetix 5300 Drives with Kinetix TLP-A/B046...TLP-A/B100 Servo Motors

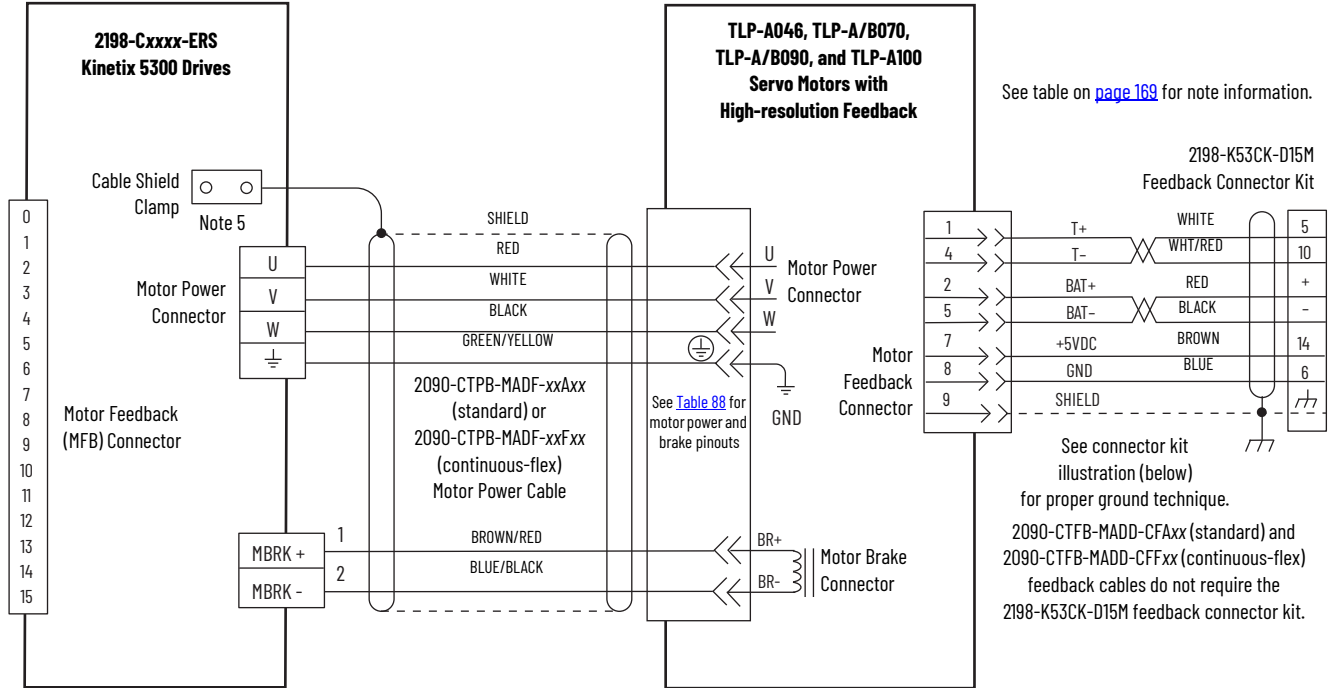

### Ground Technique for Feedback Cable Shield

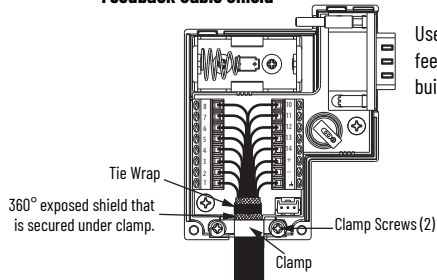

Use the 2198-K53CK-D15M feedback connector kit when building your own cables.

See Kinetix 5300 Feedback Connector Kit Installation Instructions, publication [2198-IN023](#), for connector kit specifications.

Table 88 - Motor Power and Brake Cable Pinouts

Motor Power/Brake Cable Cat. No.	Motor Power			Motor Brake		
	Signal	Wire Color	Pin	Signal	Wire Color	Pin
2090-CTPx-MADF-16	U	RED	1	BR+	BROWN	3
	V	WHITE	2			
	W	BLACK	4			
2090-CTPx-MADF-18	PE	GREEN/YELLOW	5	BR-	BLUE	5
						6

In this example, the Kinetix TLP compact motor with military-style connectors uses a power/brake cable. Flying-lead feedback connections to the 2198-K53CK-D15M feedback connector kit are made by using bulk cable and building your own cables. See Build Your Own Kinetix TLP Motor Cables Installation Instructions, publication [2090-IN048](#), for more information.

Figure 83 - Kinetix 5300 Drives with Kinetix TLP-A/B115...TLP-A/B200 Servo Motors

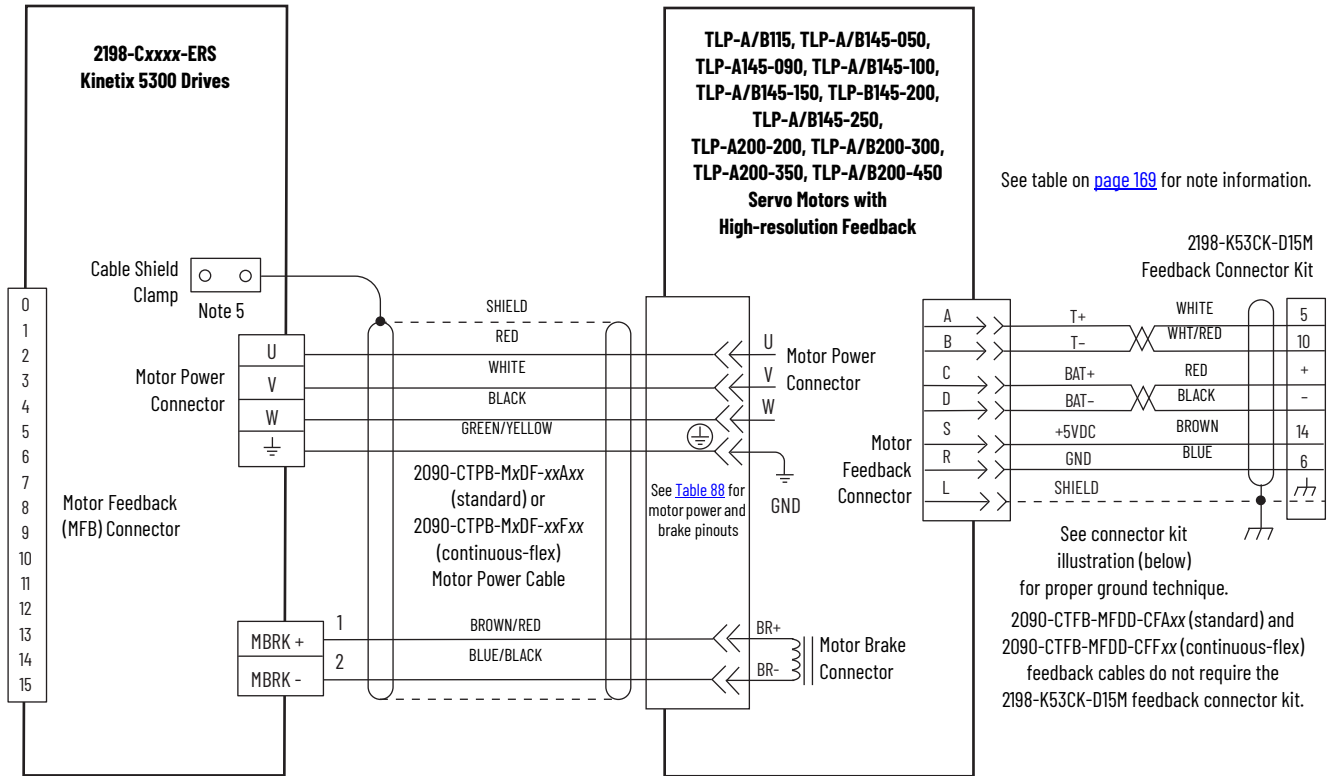

**Ground Technique for Feedback Cable Shield**

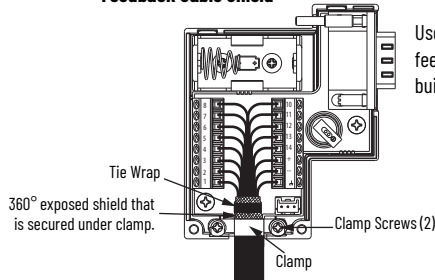

Use the 2198-K53CK-D15M feedback connector kit when building your own cables.

See Kinetix 5300 Feedback Connector Kit Installation Instructions, publication [2198-IN023](#), for connector kit specifications.

Table 89 - Motor and Brake Cable Pinouts

Motor Power/Brake Cable Cat. No.	Motor Power			Motor Brake		
	Signal	Wire Color	Pin	Signal	Wire Color	Pin
2090-CTPx-MCDF-12	U	RED	F	BR+	RED	G H
	V	WHITE	I	BR-	BLACK	
	W	BLACK	B	BR+	BROWN	
2090-CTPx-MCDF-16	PE	GREEN/YELLOW	E	BR-	BLUE	
2090-CTPx-MDDF-08	U	RED	D	BR+	RED	A B
	V	WHITE	E	BR-	BLACK	
2090-CTPx-MDDF-12	W	BLACK	F			
	PE	GREEN/YELLOW	G			

In this example, the Kinetix TLP compact motors have a separate brake (military style) connector and brake cable. Flying-lead feedback connections to the 2198-K53CK-D15M feedback connector kit are made by using bulk cables and building your own cables. See Build Your Own Kinetix TLP Motor Cables Installation Instructions, publication [2090-IN048](#), for more information.

**Figure 84 - Kinetix 5300 Drives with Kinetix TLP-A/B200-550, TLP-A/B200-750, and TLP-A/B235 Servo Motors**

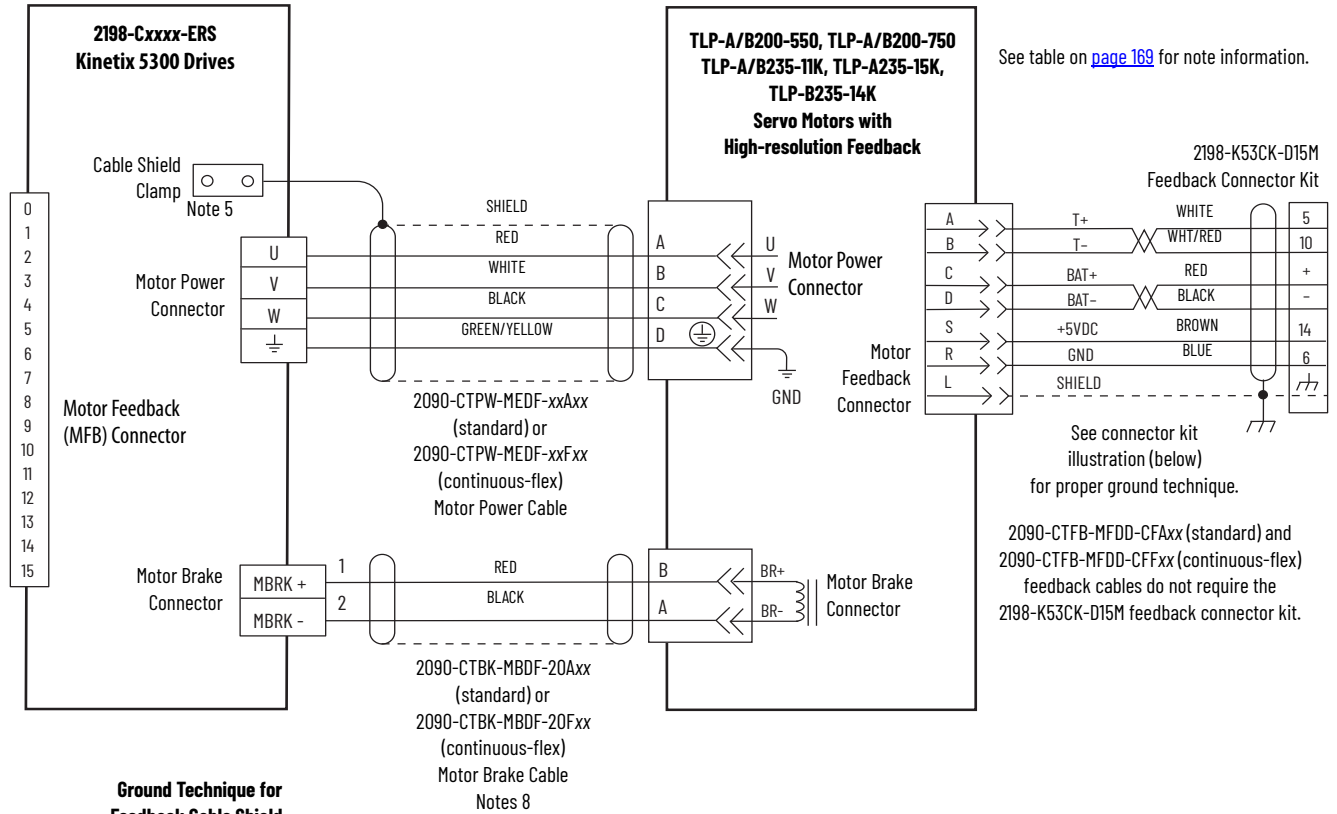

**Ground Technique for Feedback Cable Shield**

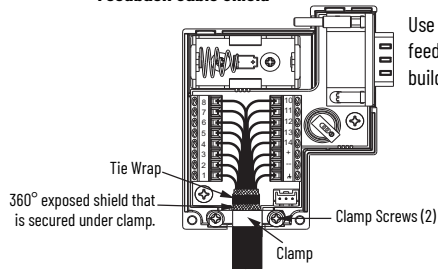

See Kinetix 5300 Feedback Connector Kit Installation Instructions, publication [2198-IN023](#), for connector kit specifications.

These compatible Kinetix MP rotary motors have separate connectors and cables for power/brake and feedback connections. Incremental encoders include S1, S2, and S3 (Hall) signals, so feedback cables with additional conductors are specified.

Figure 85 - Kinetix 5300 with Kinetix MP Rotary Servo Motors

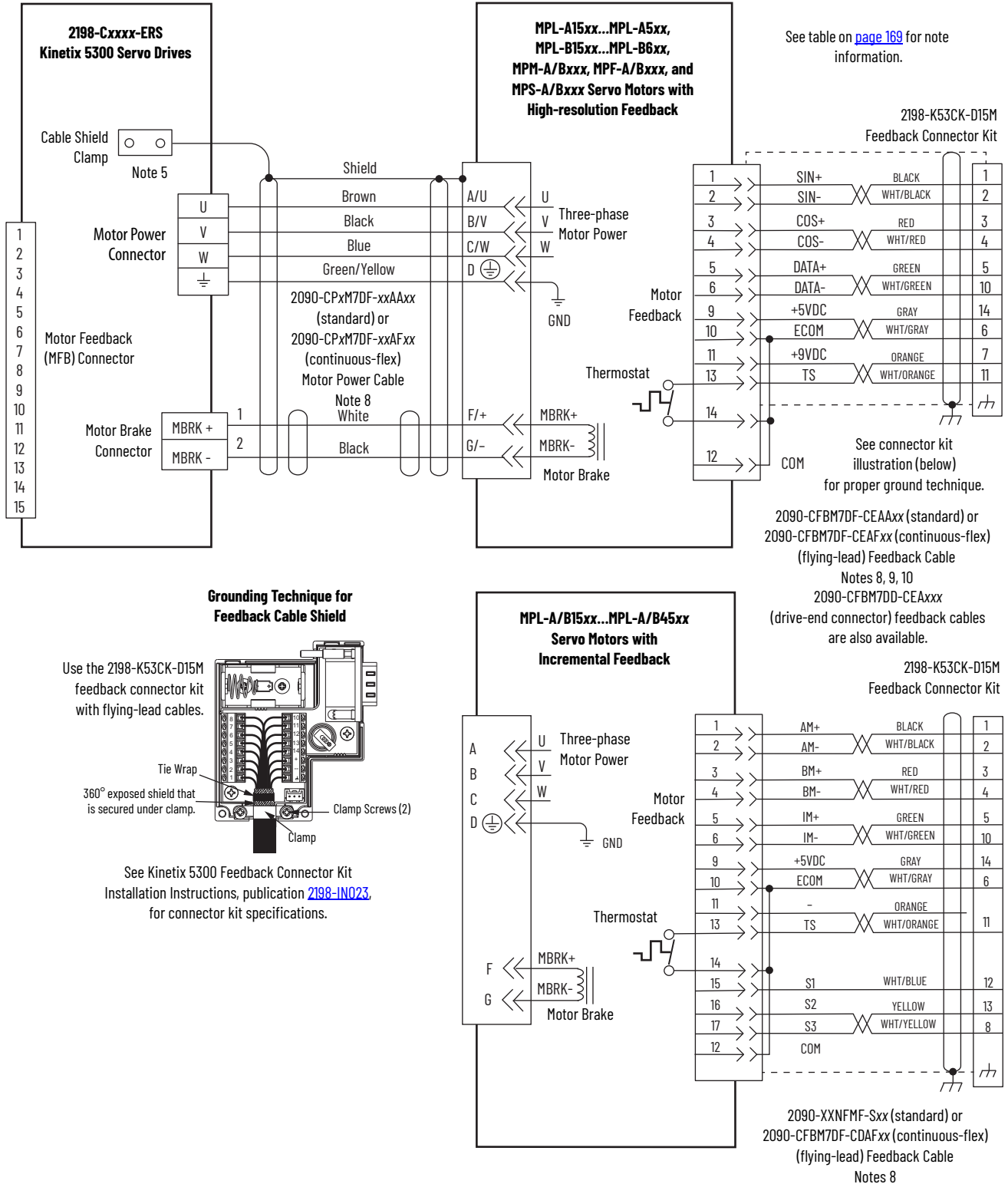



These compatible Kinetix TL and TLY rotary motors have separate connectors and cables for power/brake and feedback connections.

Figure 86 - Kinetix 5300 with Kinetix TLY Rotary Motors

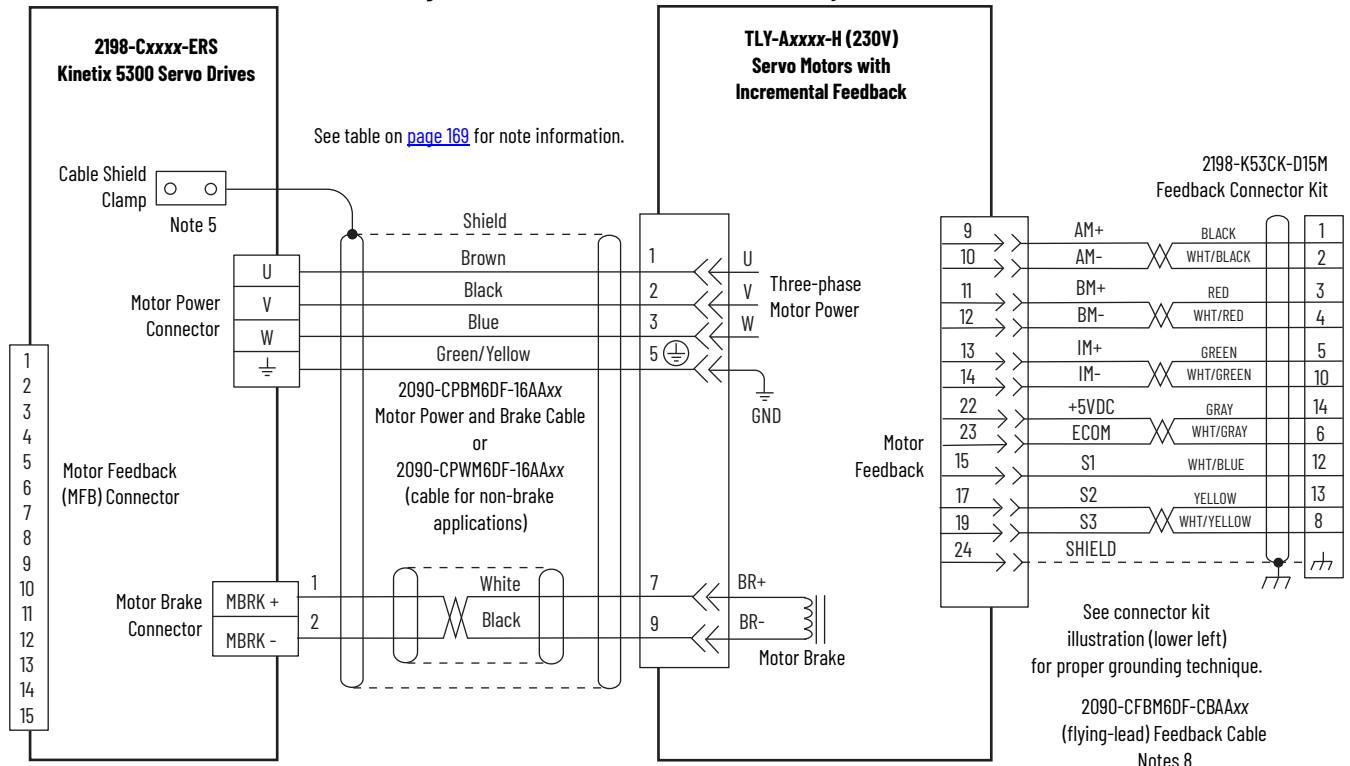

**Grounding Technique for Feedback Cable Shield**

Use the 2198-K53CK-D15M feedback connector kit with flying-lead cables.

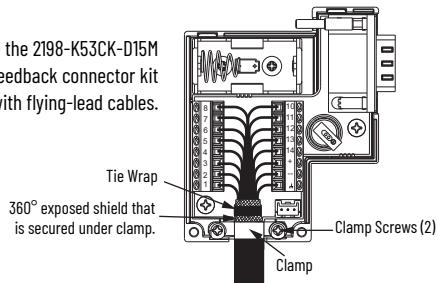

See Kinetix 5300 Feedback Connector Kit Installation Instructions, publication [2198-IN023](#), for connector kit specifications.

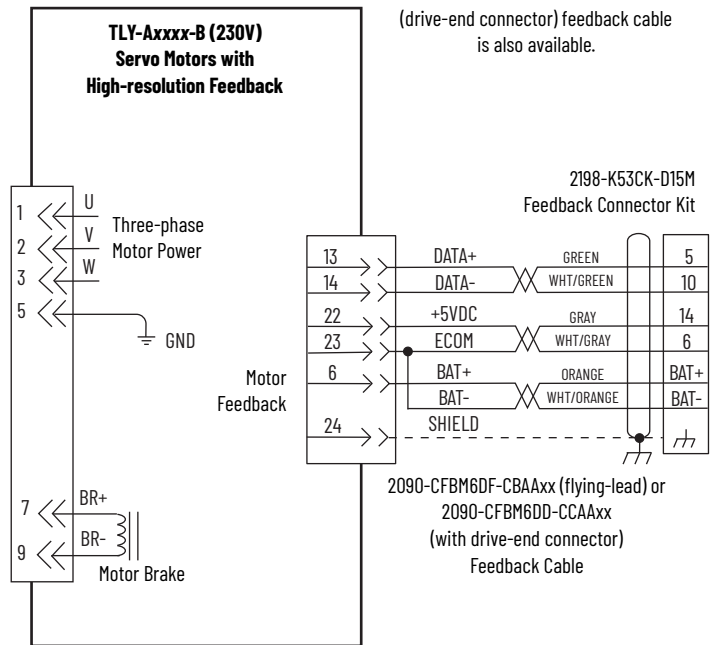

The 2090-DANFCT-Sxx feedback cable is equipped with a drive-end connector that is not compatible with the 15-pin (MFB) feedback connector. To provide battery backup to the encoder, you can remove the drive-end connector and prepare the cable shield and conductors for wiring to the 2198-K53CK-D15M feedback connector kit. For more information, see [Cable Preparation for Kinetix TL and TLY Motor Power Cables on page 86](#).

Figure 87 - Kinetix 5300 with Kinetix TL Rotary Motors

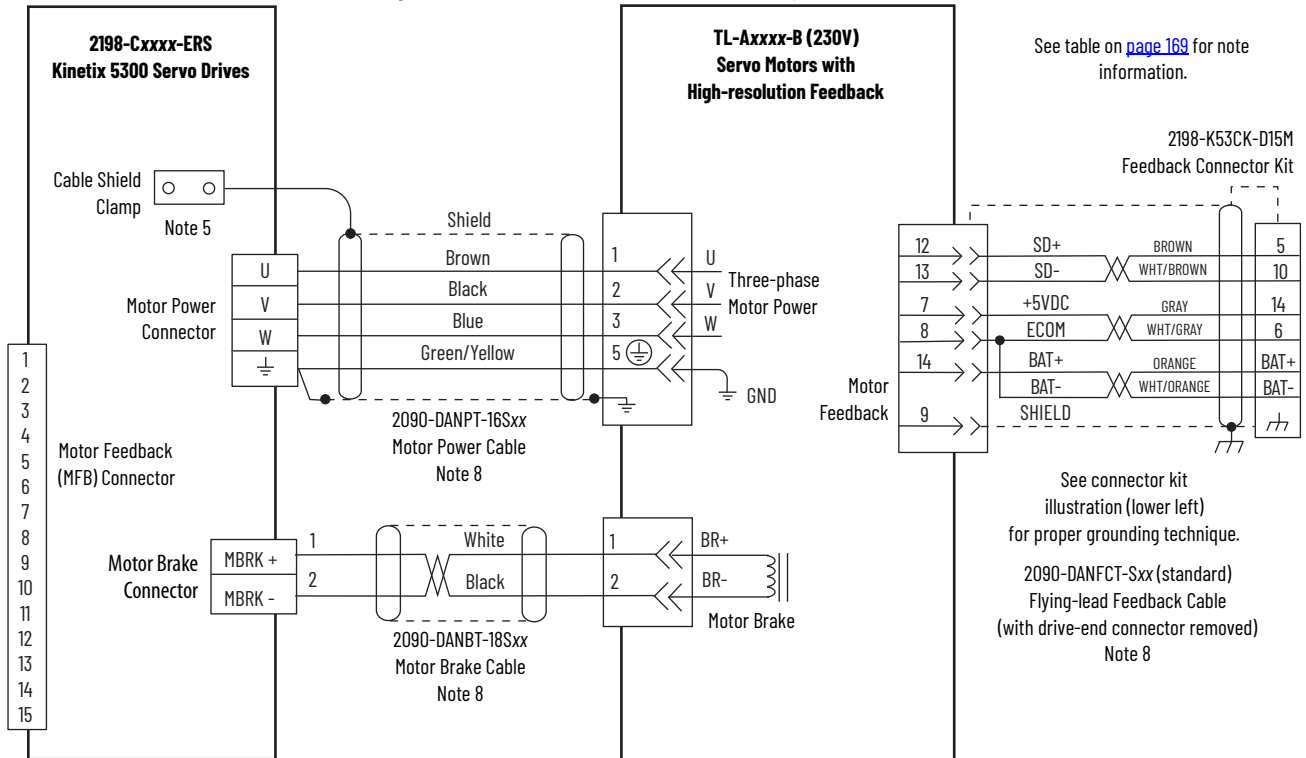

**Grounding Technique for Feedback Cable Shield**

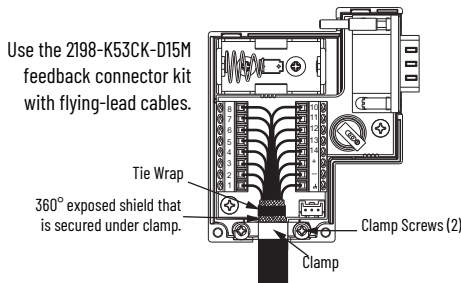

Use the 2198-K53CK-D15M feedback connector kit with flying-lead cables.  
See Kinetix 5300 Feedback Connector Kit Installation Instructions, publication [2198-IN023](#), for connector kit specifications.

# Kinetix 5300 Drive and Linear Actuator Wiring Examples

These wiring diagrams apply to Kinetix 5300 drives with compatible Allen-Bradley linear motors and actuators.

Incremental encoders include S1, S2, and S3 (Hall) signals, so feedback cables with additional conductors are specified.

Figure 88 - Kinetix 5300 with Kinetix LDAT Linear Thrusters

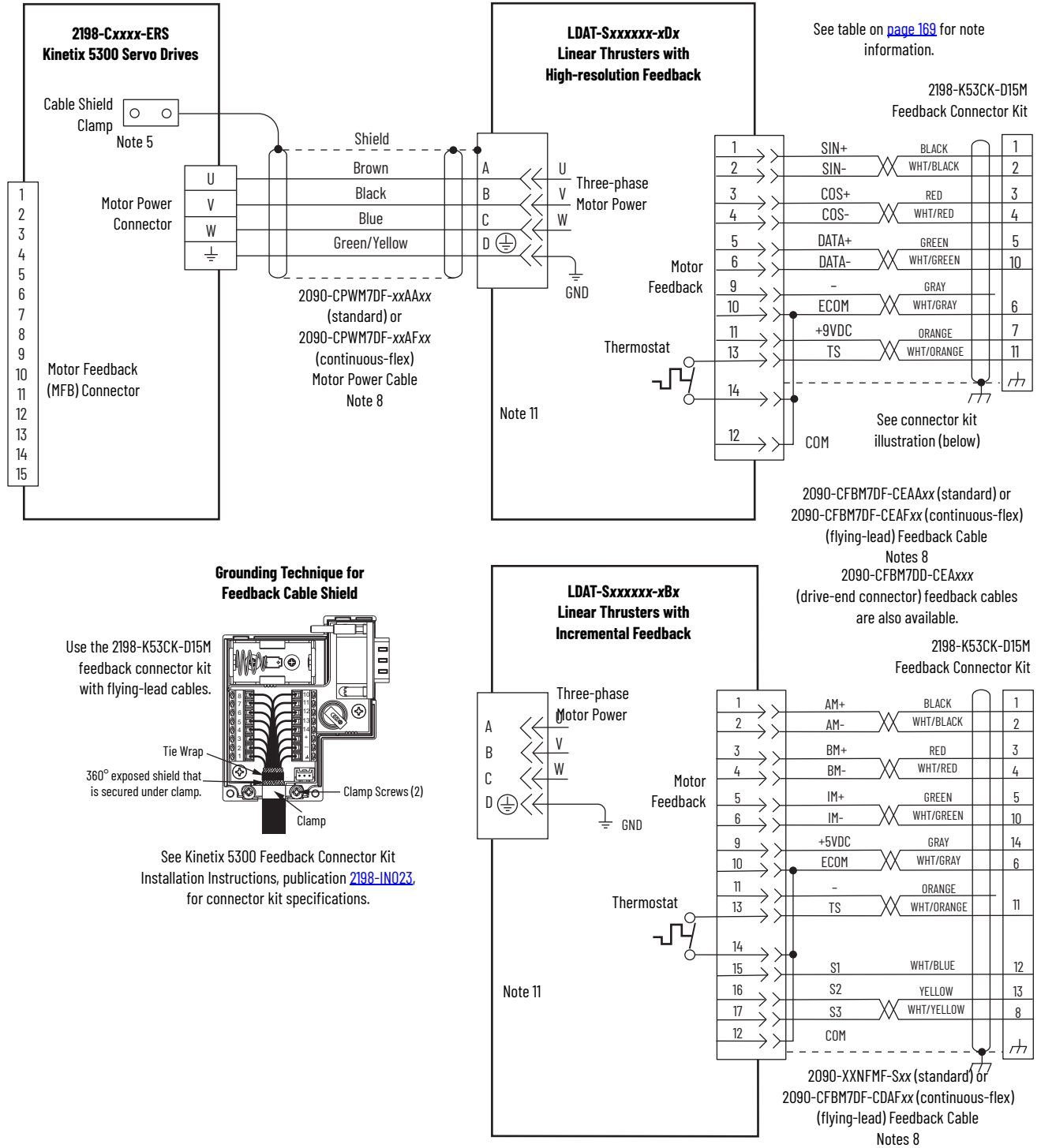

Incremental encoders include S1, S2, and S3 (Hall) signals, so feedback cables with additional conductors are specified.

Figure 89 - Kinetix 5300 with Kinetix MPAS Linear Stages

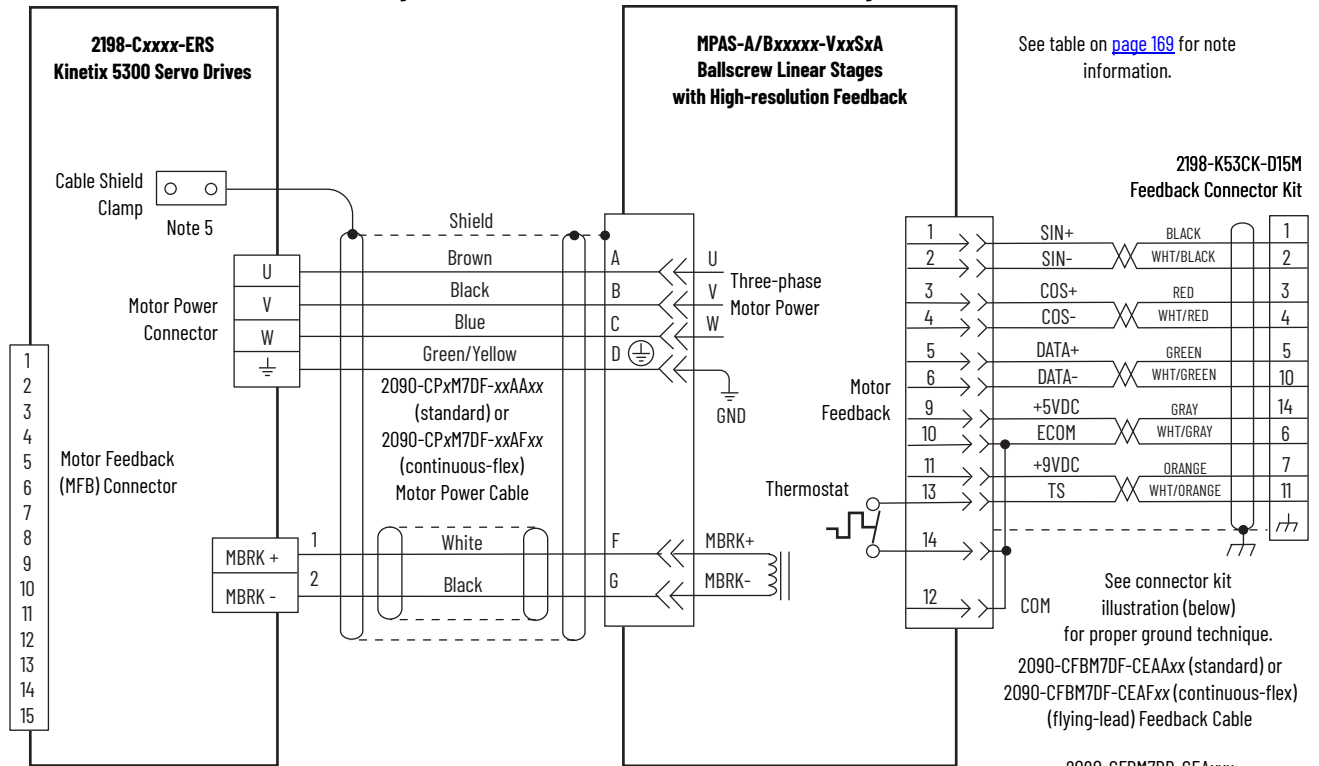

**Grounding Technique for Feedback Cable Shield**

Use the 2198-K53CK-D15M feedback connector kit with flying-lead cables.

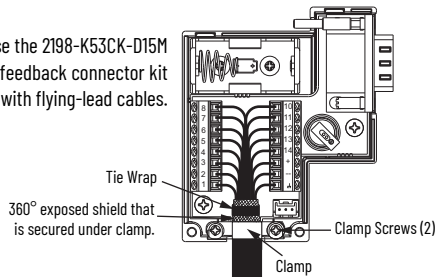

See Kinetix 5300 Feedback Connector Kit Installation Instructions, publication [2198-IN023](#), for connector kit specifications.

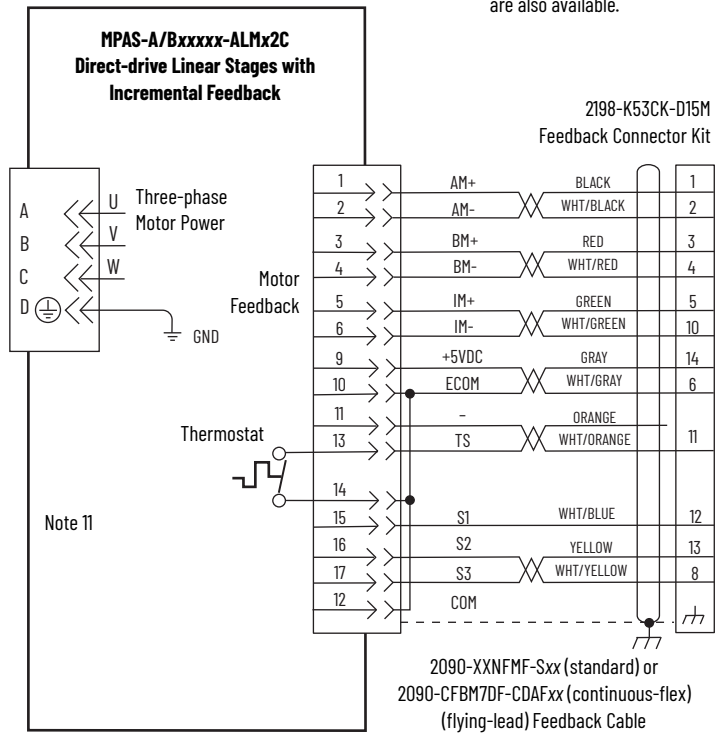
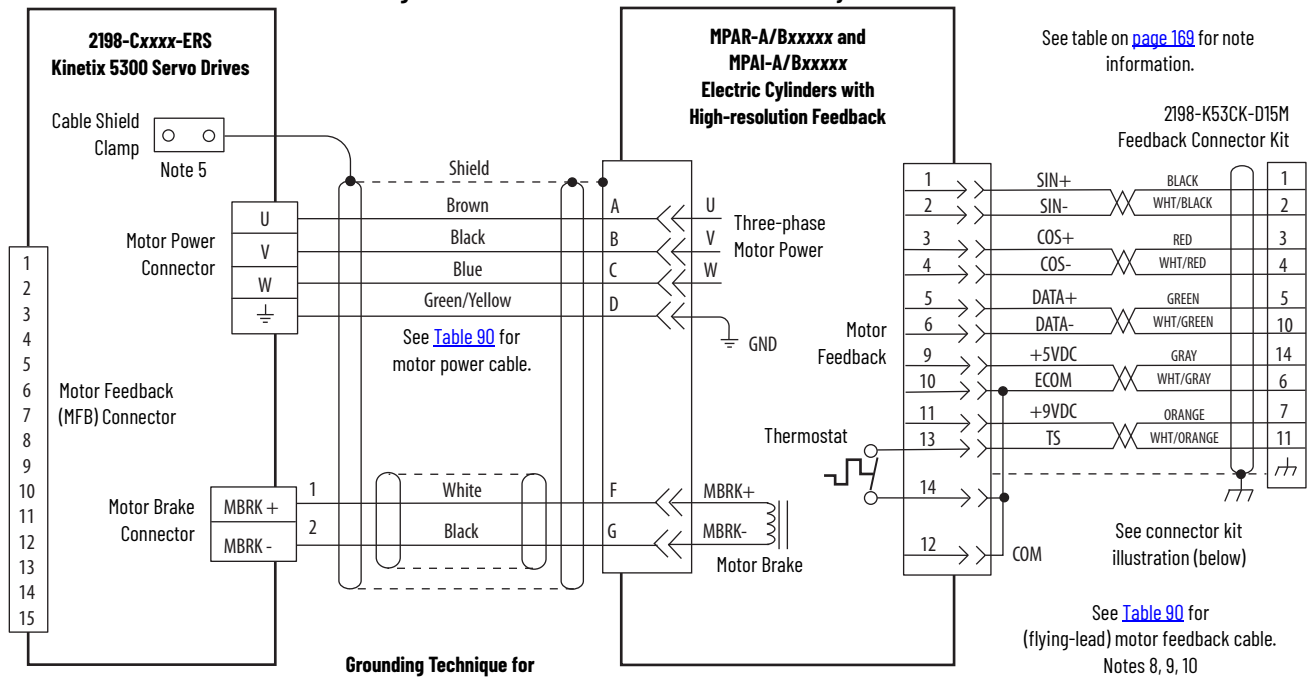
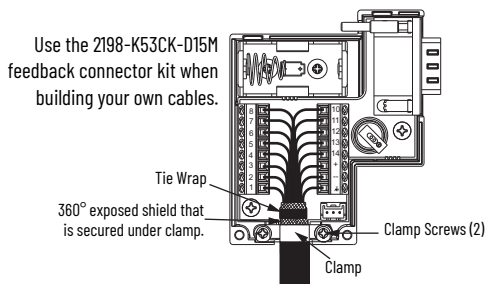

Figure 90 - Kinetix 5300 with Kinetix MP Electric Cylinders



**Grounding Technique for Feedback Cable Shield**



See Kinetix 5300 Feedback Connector Kit Installation Instructions, publication [2198-IN023](#), for connector kit specifications.

Table 90 - Kinetix MPAI and MPAR Electric Cylinder Power and Feedback Cables

Electric Cylinder Cat. No.	Frame	Power Cable Cat. No.	Feedback Cable Cat. No.
MPAR-A/B1xxx (series A and B)	32	2090-XXNPMF-16Sxx (standard) or 2090-CPxM4DF-16AFxx (continuous-flex)	2090-XXNFMF-Sxx (standard) or 2090-CFBM4DF-CDAFxx (continuous-flex)
MPAR-A/B2xxx (series A and B)	40		
MPAR-A/B1xxx (series A and B)	32	2090-CPxM7DF-16AAxx (standard) or 2090-CPxM7DF-16AFxx (continuous-flex)	2090-CFBM7DF-CEAAxx (standard) or <sup>(1)</sup> 2090-CFBM7DF-CEAFxx (continuous-flex)
MPAR-A/B2xxx (series A and B)	40		
MPAR-A/B3xxx	63		
MPAI-A/B2xxxx	64		
MPAI-A/B3xxxx	83		
MPAI-A/B4xxxx	110		
MPAI-B5xxxx	144		
MPAI-A5xxxx	144	2090-CPxM7DF-14AAxx (standard) or 2090-CPxM7DF-14AFxx (continuous-flex)	2090-CFBM7DF-CEAAxx (standard) or <sup>(1)</sup> 2090-CFBM7DF-CEAFxx (continuous-flex)

(1) 2090-CFBM7DD-CEAxxx (drive-end connector) feedback cables are also available.

Kinetix LDC and Kinetix LDL linear motors do not include the holding-brake option, so 2090-CPWM7DF cables (without brake wires) are specified. Incremental encoders include the S1, S2, and S3 (Hall) signals, so feedback cables with additional conductors are specified.

Figure 91 - Kinetix 5300 with Kinetix LDC or Kinetix LDL Linear Motors (cable connectors)

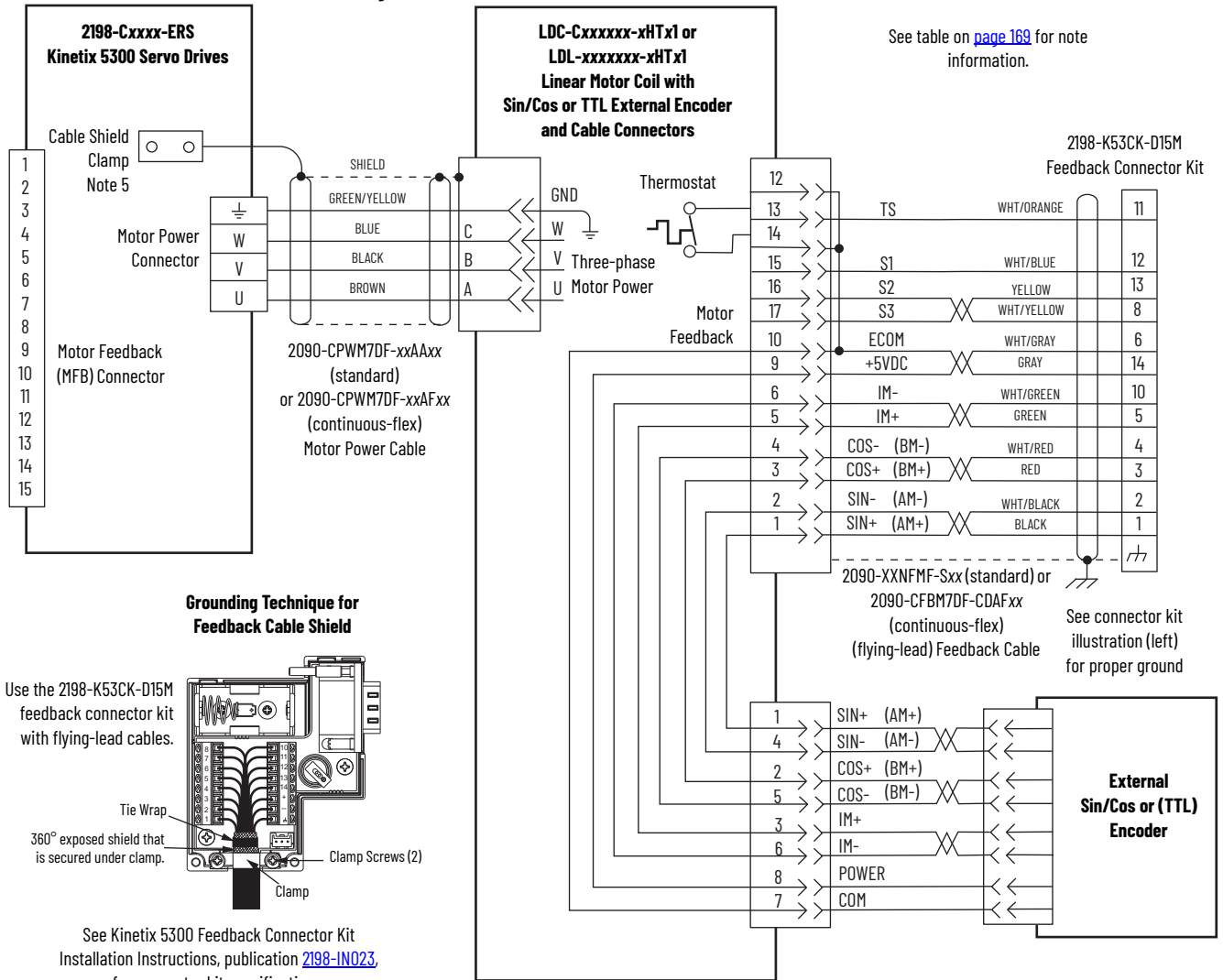

Incremental encoders include S1, S2, and S3 (Hall) signals, so feedback cables with additional conductors are specified.

Figure 92 - Kinetix 5300 with Kinetix LDC or Kinetix LDL Linear Motors (flying-lead cables)

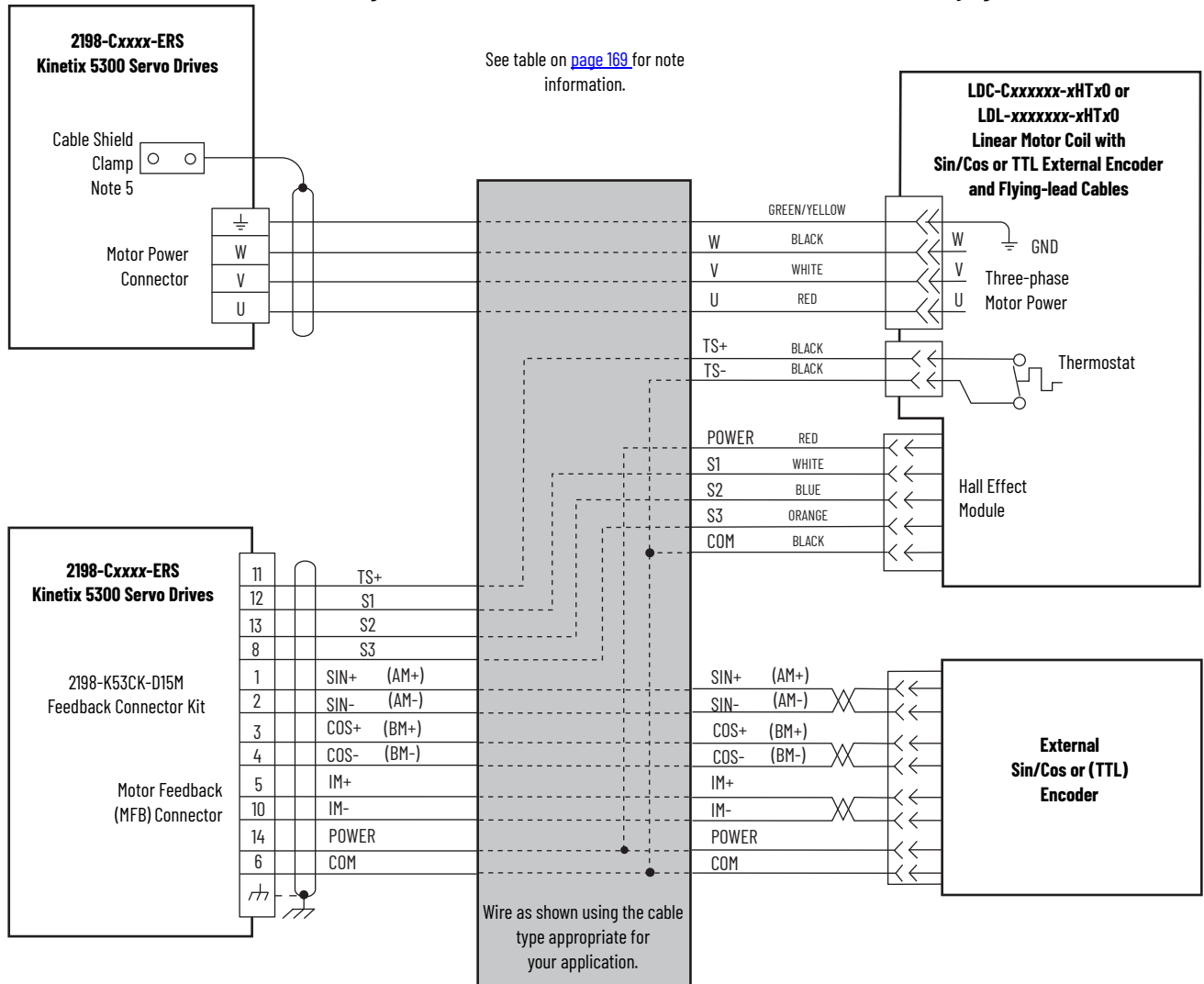

**Grounding Technique for Feedback Cable Shield**

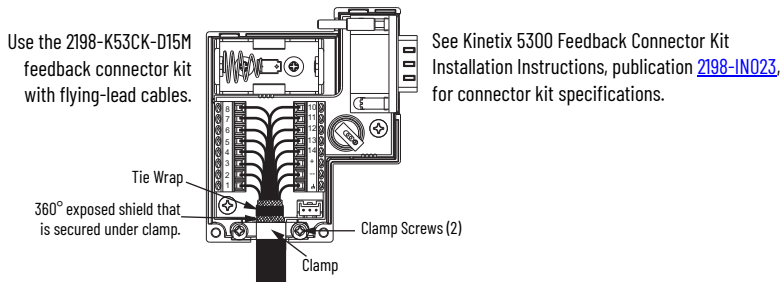

# System Block Diagrams

This section provides block diagrams of the Kinetix 5300 servo drives.

Figure 93 - Kinetix 5300 Drive Block Diagram

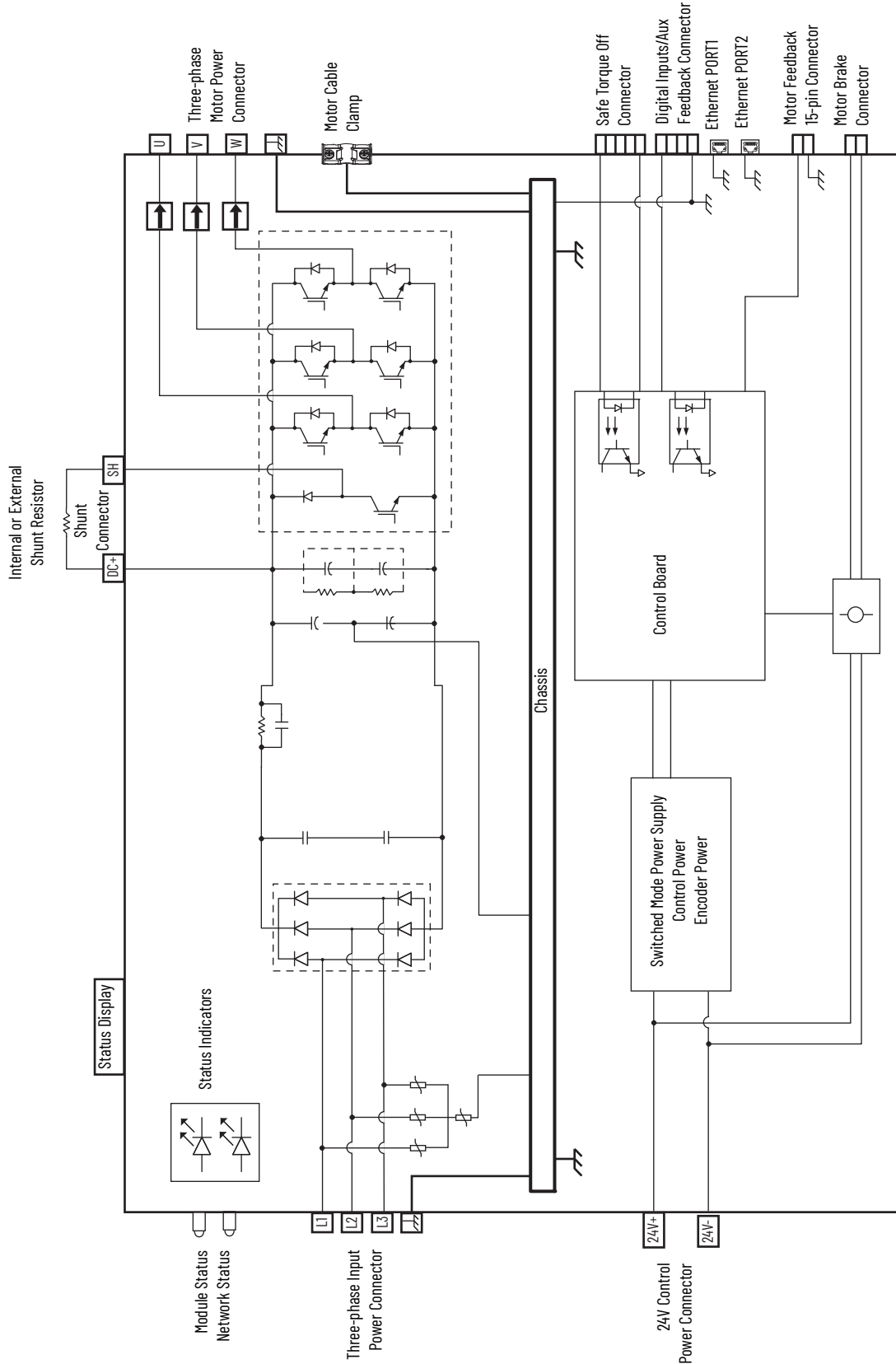



## Update Kinetix 5300 Drive Firmware

This appendix provides procedures to update your Kinetix® 5300 drive firmware.

Topic	Page
Before You Begin	185
Update Your Firmware	187
Verify the Firmware Update	195

You can update your Kinetix 5300 drive firmware by using either of these two methods:

- ControlFLASH Plus™ software
- ControlFLASH™ software

To update the drive firmware, you must configure a path to your drive, select the drive module to update, and complete the firmware update procedure.



We recommend that you use ControlFLASH Plus software for firmware updates. See the ControlFLASH Plus Quick Start Guide, publication [CFP-QS001](#), for more information.

### Before You Begin

For firmware updates, you must use the software versions that are shown in for EtherNet/IP™ networks.

**Table 91 - Kinetix 5300 System Requirements**

Description	Revision
Studio 5000 Logix Designer® application	33.00.00 or later
RSLinx® software <sup>(1)</sup>	4.20.00 or later
FactoryTalk® Linx software <sup>(2)</sup>	6.20.00 or later
ControlFLASH software kit <sup>(3)</sup>	15.03.00 or later
ControlFLASH Plus software kit <sup>(3)</sup>	3.01 or later

(1) Only required when using ControlFLASH software.

(2) Only required when using ControlFLASH Plus software.

(3) Download the ControlFLASH software kit from the Product Compatibility and Download Center at: [rok.auto/pcdc](http://rok.auto/pcdc). For more ControlFLASH software information (not Kinetix 5300 specific), see the ControlFLASH User Manual, publication [1756-UM105](#).

Gather this information before you begin your firmware update.

- Network path to the targeted Kinetix 5300 drives you want to update.
- Catalog numbers of the targeted Kinetix 5300 drives you want to update.

---

**IMPORTANT** Control power must be present at the control input power connector, pin-1 (24V+) and pin-2 (24V-) before updating your target drive.

---



---

**IMPORTANT** The axis state on the status display must represent STANDBY, CONFIGURING, or PRECHARGE before beginning this procedure. For the numeric values, see [Table 59 on page 104](#).

---



---

**IMPORTANT** The axis state on the status display must represent STANDBY, when Protected mode is enabled. For the numeric values, see [Table 59 on page 104](#).

---



**ATTENTION:** To avoid personal injury or damage to equipment during the firmware update due to unpredictable motor activity, do not apply three-phase AC or common-bus DC input power to the drive.

---

## Inhibit the Module

You must inhibit the Kinetix 5300 drive before performing the firmware update. Follow these steps to inhibit a module.

1. Open your Logix Designer application.
2. Right-click the Kinetix 5300 drive you configured and choose Properties.

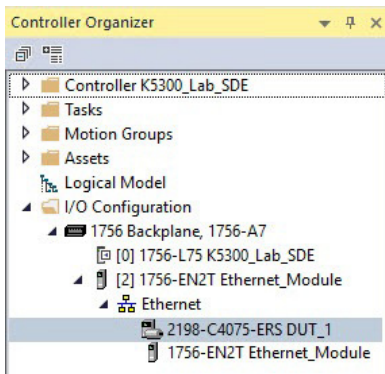

The Module Properties dialog box appears.

3. Select the Connection category.

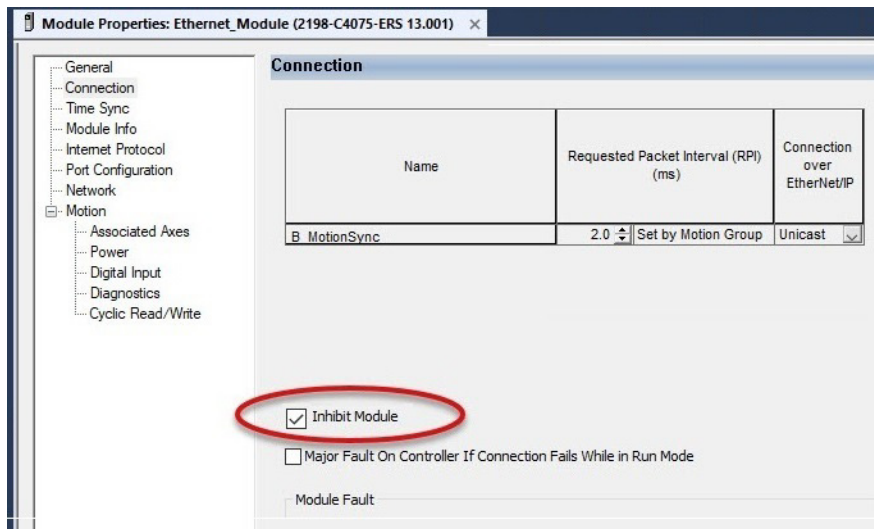

4. Check Inhibit Module.
5. Click OK.
6. Save your file and download the program to the controller.
7. Verify that the network (NET) and module (MOD) status indicators are flashing green.

## Update Your Firmware

Use either ControlFLASH Plus software or ControlFLASH software to update your firmware.

- To use ControlFLASH Plus software, see [Use ControlFLASH Plus Software to Update Your Drive Firmware](#).
- To use ControlFLASH software, see [Use ControlFLASH Software to Update Your Drive Firmware](#) on page 191.

### Use ControlFLASH Plus Software to Update Your Drive Firmware

Follow these steps to select the Kinetix 5300 drive to update.

1. Start ControlFLASH Plus software.



You can choose to select and update the firmware for all drive modules in your system. However, in this procedure only one drive is selected for a firmware update.

2. Click the Flash Devices tab. If the device is not already present next to “Browsing from path:”, complete these steps:
  - a. Click .

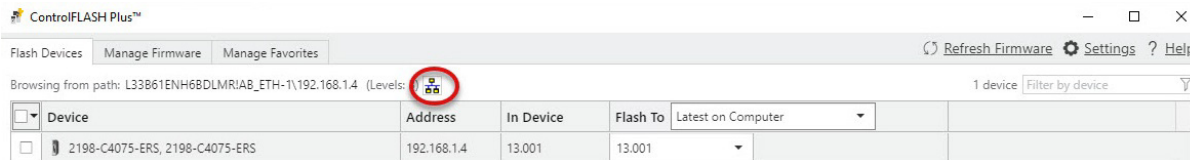

- b. In the Network Browser dialog box, locate and select the device to update.

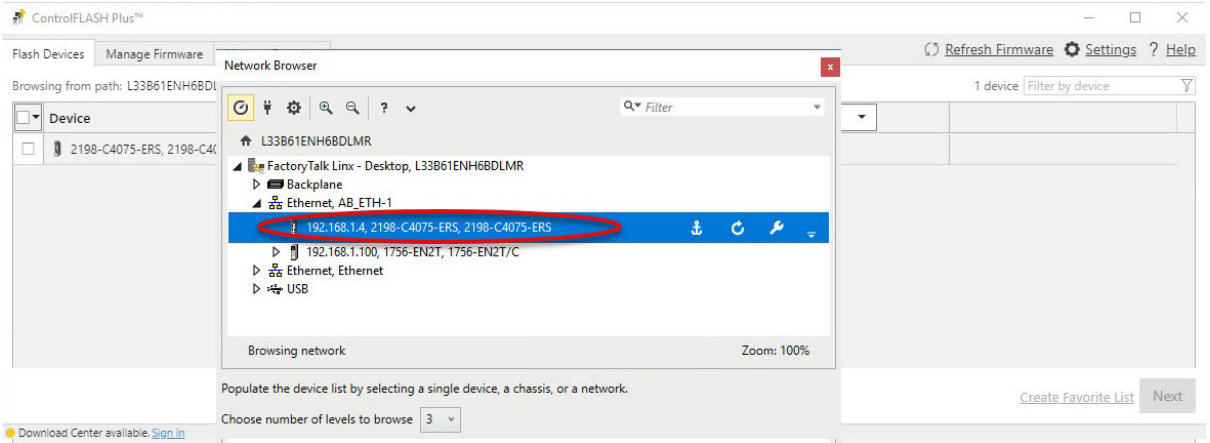

- c. Click OK.
3. On the Flash Devices tab, verify that the checkbox to the left of the device has a check in it.

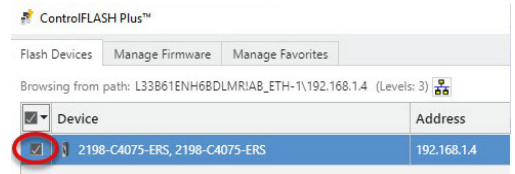

4. From the Flash To pull-down menu, choose one of these methods for choosing the desired firmware revision:
  - Latest from Download Center
  - Latest on Computer



If you have already downloaded the firmware, choose Latest on Computer and select the desired revision. Otherwise, choose Latest from Download Center and select the revision that you want.

In this example, the Latest on Computer method is chosen.

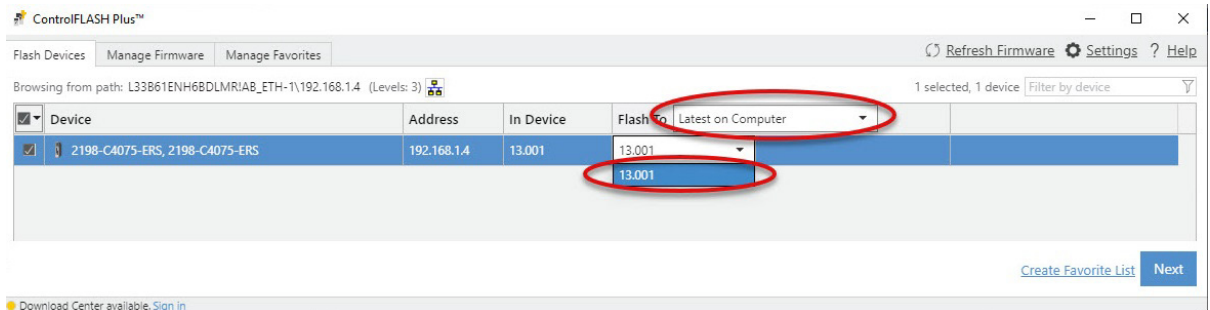

5. Click Next.
6. If a warning dialog box appears, read the warning, complete any recommendations, and click Close.

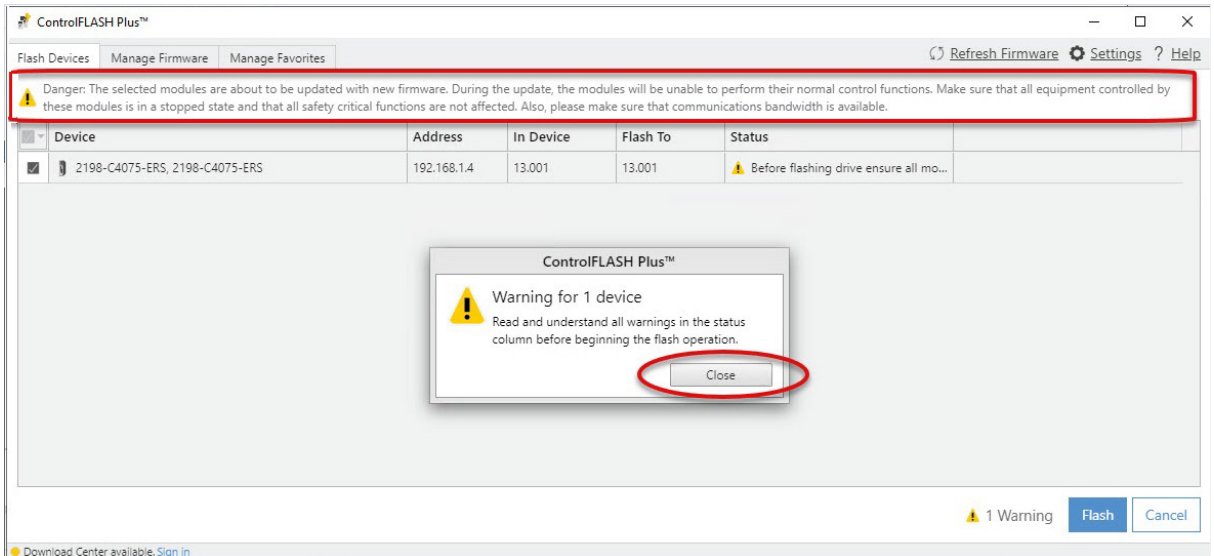

7. After acknowledging all warnings and confirming the desired revisions, click Flash.

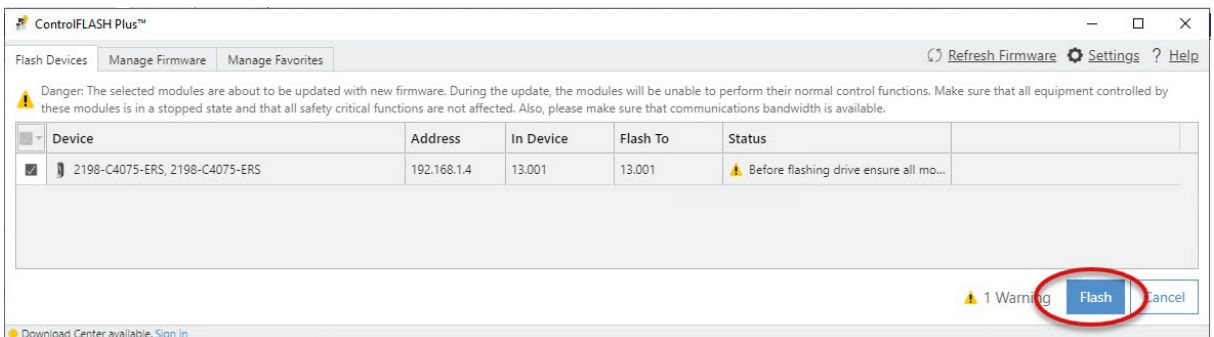

The Status bar appears to show the progress of the firmware update. Also, the status display scrolls 'Updating. Do Not Turn Off', which indicates that the update is in progress.

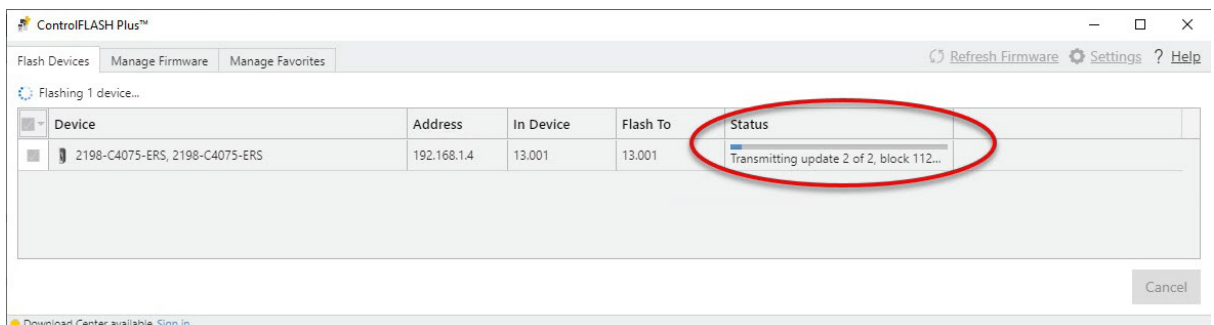

After the update information is sent to the drive, the drive resets and performs diagnostic checking. After the download, the drive applies the new firmware and reboots. This process can take several minutes.

**IMPORTANT** Do not cycle power to the drive during this process. A power cycle results in an unsuccessful firmware update and an inoperable module.

After the drive reboots, ControlFLASH Plus software indicates success or failure of the update.

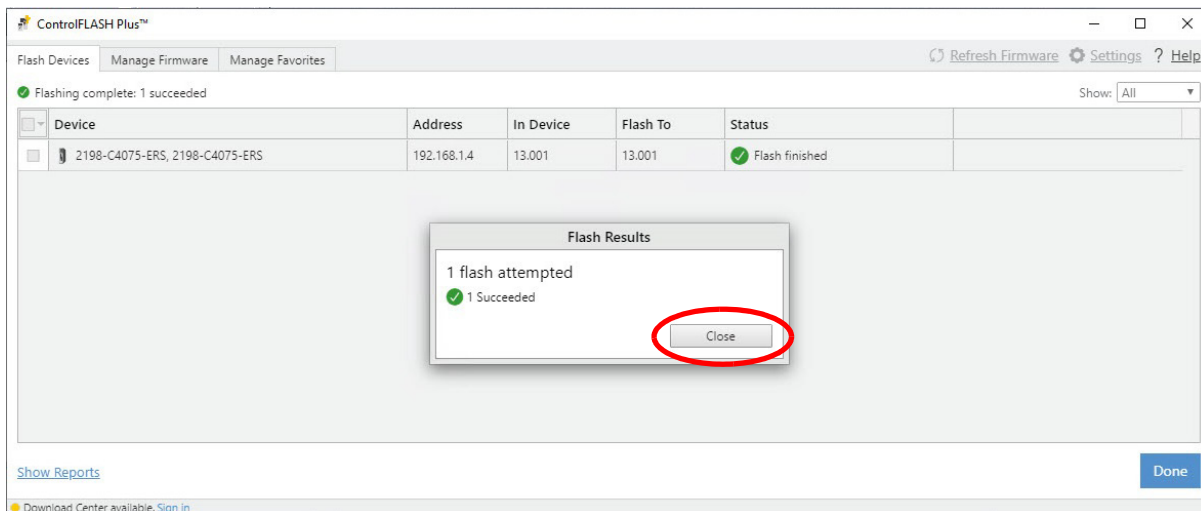

8. When the update has completed, click Close.
9. To complete the process and close the application, click Done.

---

**IMPORTANT** You must return to the drive Module Properties>Connection category to clear the Inhibit Module checkbox before resuming normal operation.

---

## Use ControlFLASH Software to Update Your Drive Firmware

Before using ControlFLASH software, you must configure the communication path by using RSLinx software.

### Configure Your Communication Path with RSLinx Software

This procedure assumes that your communication method to the target device is the Ethernet network. It also assumes that any Ethernet communication module or Logix 5000® controller in the communication path has already been configured.

For more controller information, see [Additional Resources on page 10](#).

Follow these steps to configure the communication path to the target device.

1. Open your RSLinx Classic software.
2. From the Communications menu, choose Configure Drivers.

The Configure Drivers dialog box appears.

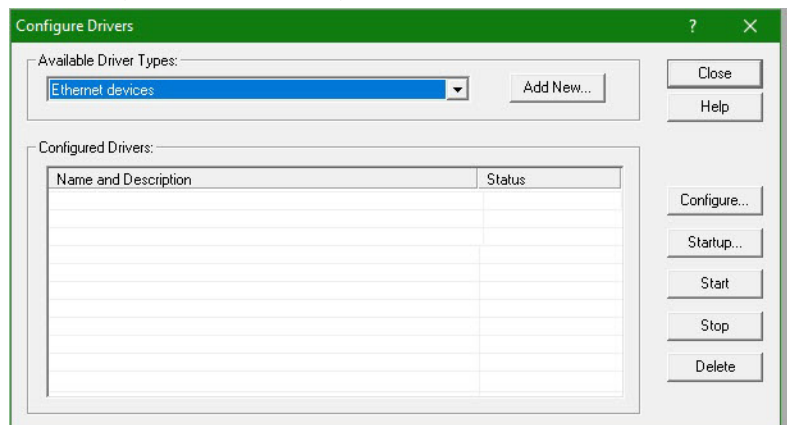

3. From the Available Driver Types pull-down menu, choose Ethernet devices.
4. Click Add New.

The Add New RSLinx Classic Driver dialog box appears.

5. Type the new driver name.

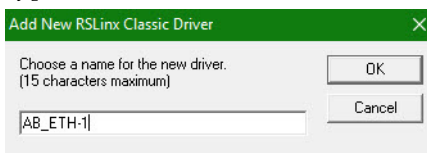

6. Click OK.

The Configure driver dialog box appears.

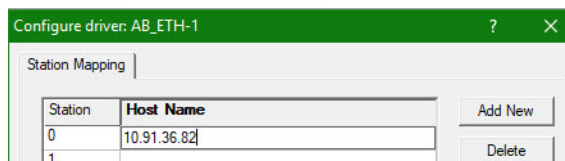

7. Type the IP address of your Ethernet Module or Controller that bridges between the Ethernet network and the EtherNet/IP network.
8. Click OK.

The new Ethernet driver appears under Configured Drivers.

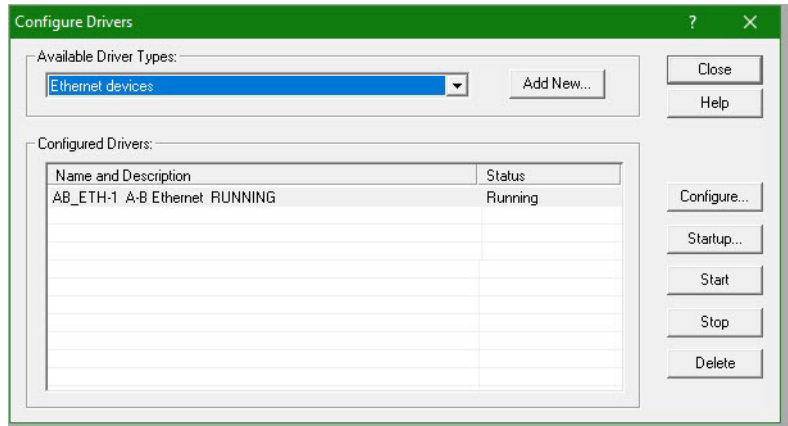

9. Click Close.
10. Minimize the RSLinx application dialog box.

### Start the ControlFLASH Software

Follow these steps to start ControlFLASH software and begin your firmware update.

1. In the Logix Designer application, from the Tools menu, choose ControlFLASH.



You can also open the ControlFLASH software by choosing Start > Programs > FLASH Programming Tools > ControlFLASH.

The Welcome to ControlFLASH dialog box appears.

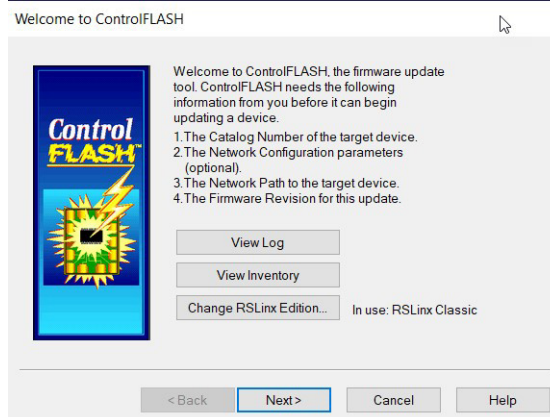

2. Click Next.  
The Catalog Number dialog box appears.

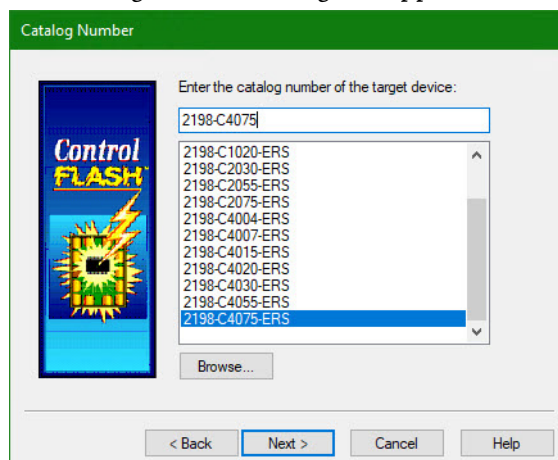





If your catalog number does not appear, click Browse, select the monitored folder where the firmware kit (DMK files) is located. Click Add and OK.

3. Select your Kinetix 5300 drive.  
In this example, the 2198-C4075-ERS drive is selected.
4. Click Next.

The Select Device to Update dialog box appears.

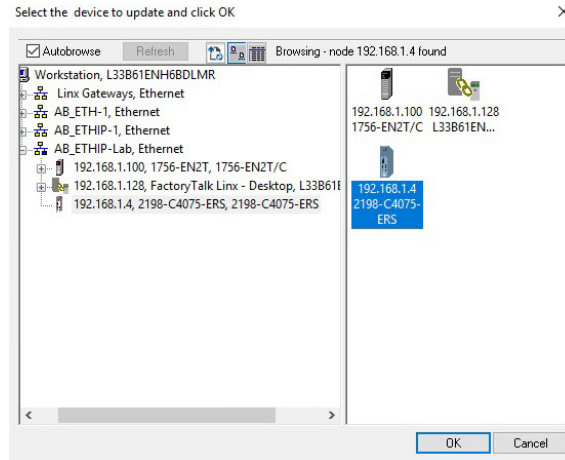

5. Expand your Ethernet node, Logix backplane, and EtherNet/IP network module.
6. Select the Kinetix 5300 drive to update.
7. Click OK.

The Firmware Revision dialog box appears.

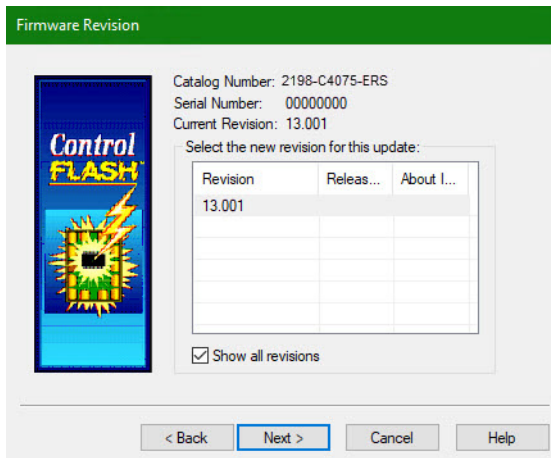

8. Select the firmware revision to use for the update.
9. Click Next.

The Summary dialog box appears.

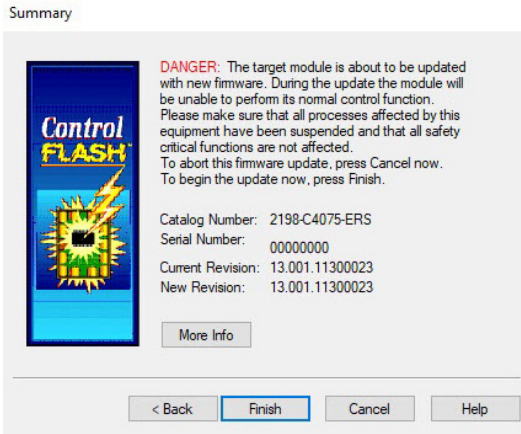

10. Confirm the device catalog number and firmware revision.
11. Click Finish.

This ControlFLASH warning dialog box appears.

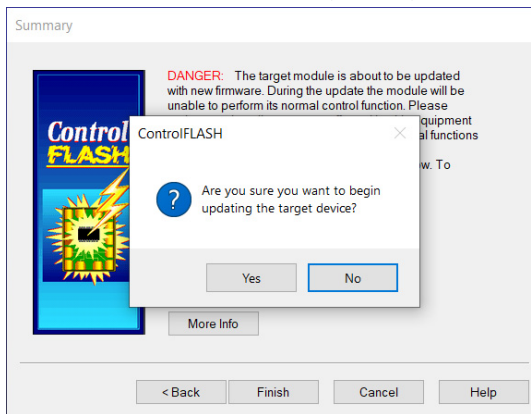

12. To complete the update now, click Yes.

This ControlFLASH warning dialog box appears.

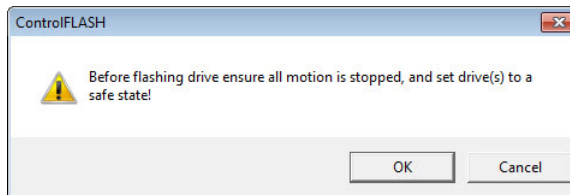

13. Acknowledge the warning and click OK.

The Progress dialog box appears and updating begins.

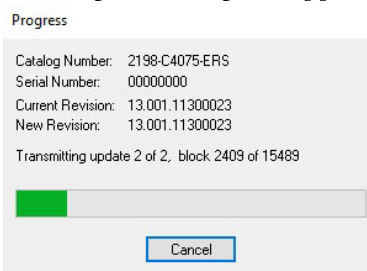

After the update information is sent to the drive, the drive resets and performs diagnostic checking.

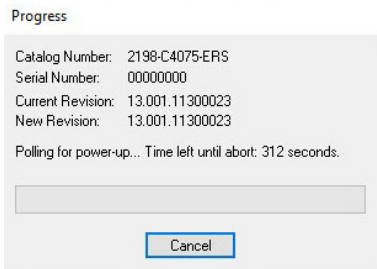

- Wait for the Progress dialog box to time out. It is normal for this process to take several minutes.

---

**IMPORTANT** Do not cycle power to the drive during this process. A power cycle results in an unsuccessful firmware update and an inoperable module.

---

- Verify that the Update Status dialog box appears and indicates success or failure and take the appropriate action as described in the following table.

Update Status	Display	Action
Success	The Update complete message appears in a green Status dialog box.	Go to <a href="#">step 16</a> .
Failure	The Update failure message appears in a red Status dialog box.	See the ControlFLASH User Manual, publication <a href="#">1756-UM105</a> , for troubleshooting information.

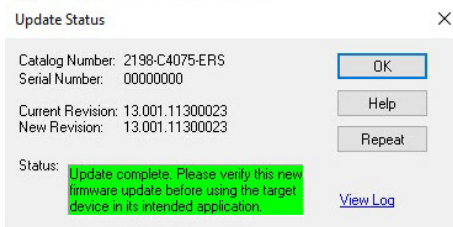

- Click OK.

---

**IMPORTANT** You must return to the drive Module Properties > Connection category to clear the Inhibit Module checkbox before resuming normal operation.

---

## Verify the Firmware Update

Follow these steps to verify that your firmware update was successful.



Verifying the firmware update is optional.

- Open your RSLinx software.
- From the Communications menu, choose RSWho.

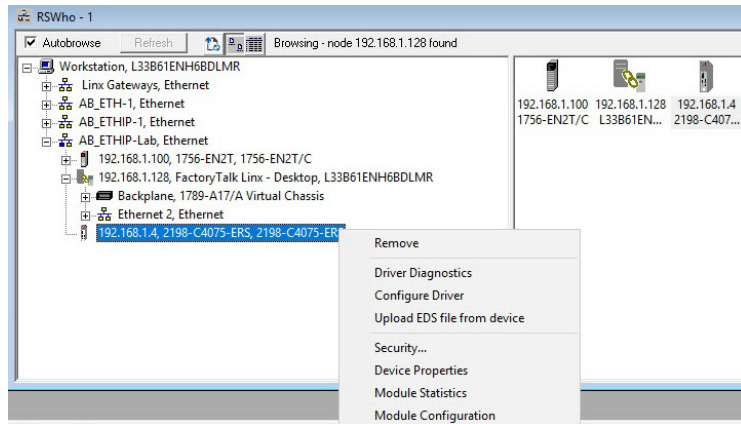

3. Expand your Ethernet node, Logix backplane, and EtherNet/IP network module.
4. Right-click the drive and choose Device Properties.  
The Device Properties dialog box appears.

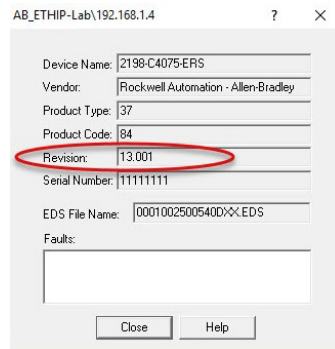

5. Verify the new firmware revision level.
6. Click Close.

## Motor Control Feature Support

This appendix provides feature descriptions for induction motors and permanent-magnet motors that are supported by Kinetix® 5300 servo drives.

<b>Topic</b>	<b>Page</b>
Frequency Control Methods	198
Current Limiting for Frequency Control	202
Stability Control for Frequency Control	205
Skip Speeds	207
Flux Up	209
Current Regulator Loop Settings	212
Motor Category	212
Selection of Motor Thermal Models	218
Speed Limited Adjustable Torque (SLAT)	221
Motor Overload Retention	231
Phase Loss Detection	232
Velocity Droop	234
Commutation Self-sensing Startup	236
Commutation Test	237
Adaptive Tuning	238
Virtual Torque Sensor	238

## Frequency Control Methods

The Kinetix 5300 servo drives support three open-loop frequency control methods. The choices are the following:

- **Basic Volts/Hertz** - This method is used in single asynchronous-motor applications
- **Basic Volts/Hertz - Fan Pump** - This method is similar to Basic Volts/Hertz, but is tailored for fan/pump applications
- **Sensorless Vector with Slip Compensation** - This method is used for most constant torque applications. Provides excellent starting, acceleration, and running torque

To configure your induction motor in the Logix Designer application, refer to [Configure Induction-motor Closed-loop Control Axis Properties on page 128](#).

Open-loop frequency control is suitable in applications such as conveyors, pumps, and fans. Features include the following:

- Start Boost and Run Boost
- Electronic motor thermal-overload protection per Class 10 requirements
- Two skip frequencies, in which the drive does not operate
- All three-phase induction motors, suitable for variable speed drive (VFD) operation, are supported

**Table 92 - Motor Specifications**

Attribute	Value
Output frequency, max	590 Hz
Pole pairs, max	50
Motor cable length, max	30 m (98.4 ft)

## Basic Volts/Hertz

Volts/hertz operation creates a fixed relationship between output voltage and output frequency. Voltage is applied to the motor, which is based on the operating frequency command at a fixed volts/hertz ratio. The ratio is calculated from the motor nameplate data and entered into the Logix Designer application > Axis Properties > Frequency Control category.

The Basic Volts/Hertz method provides various patterns. The default configuration is a straight line from zero to rated voltage and frequency. As seen in [Figure 94](#), you can change the volts/hertz ratio to provide increased torque performance when required by programming five distinct points on the curve.

**Table 93 - Basic Volts/Hertz Definitions**

Curve Feature	Definition
Start boost	Used to create additional torque for breakaway from zero speed and acceleration of heavy loads at lower speeds.
Run boost	Used to create additional running torque at low speeds. The value is typically less than the required acceleration torque. The drive lowers the boost voltage to this level when running at low speeds (not accelerating). This reduces excess motor heating that could result if the higher start/accel boost level were used.
Break voltage/frequency	Used to increase the slope of the lower portion of the Volts/Hertz curve, providing additional torque.
Motor nameplate voltage/frequency	Sets the upper portion of the curve to match the motor design. Marks the beginning of the constant power region.
Maximum voltage/frequency	Slopes the portion of the curve that is used above base speed.

**Figure 94 - Basic Volts/Hertz Method**

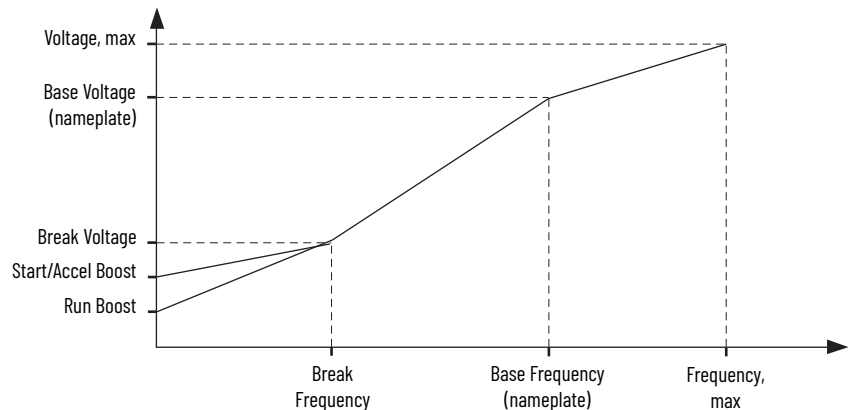

## Basic Volts/Hertz for Fan/Pump Applications

The Basic Volts/Hertz Fan/Pump (fan/pump) method is based on the Basic Volts/Hertz (V/Hz) method, but is tailored for fan/pump applications.

**Figure 95 - Output Voltage Equation**

$$V_x = \left( \frac{f_x}{f_n} \right)^2 (V_n - V_{boost}) + V_{boost}$$

Where:  
 $V_x$  = Output voltage  
 $f_x$  = Output frequency  
 $V_n$  = Rated voltage  
 $f_n$  = Rated frequency  
 $V_{boost}$  = Run boost voltage

For maximum system efficiency, fan/pump loads use variable-frequency drives that are equipped with a specific V/Hz curve where the voltage is proportional to the square of the frequency.

**Figure 96 - Basic Volts/Hertz Fan/Pump Method**

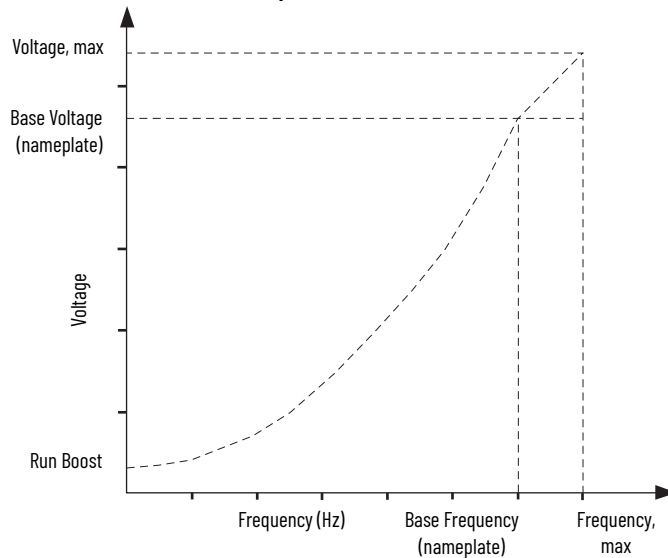

The Fan/Pump control method supports the run-boost attribute, but does not support break-voltage, break-frequency, or start-boost.



## Sensorless Vector

The Sensorless Vector method uses a volts/hertz core that is enhanced by a current resolver, slip estimator, and a voltage-boost compensator based on the operating conditions of the motor.

**Figure 97 - Sensorless Vector Method**

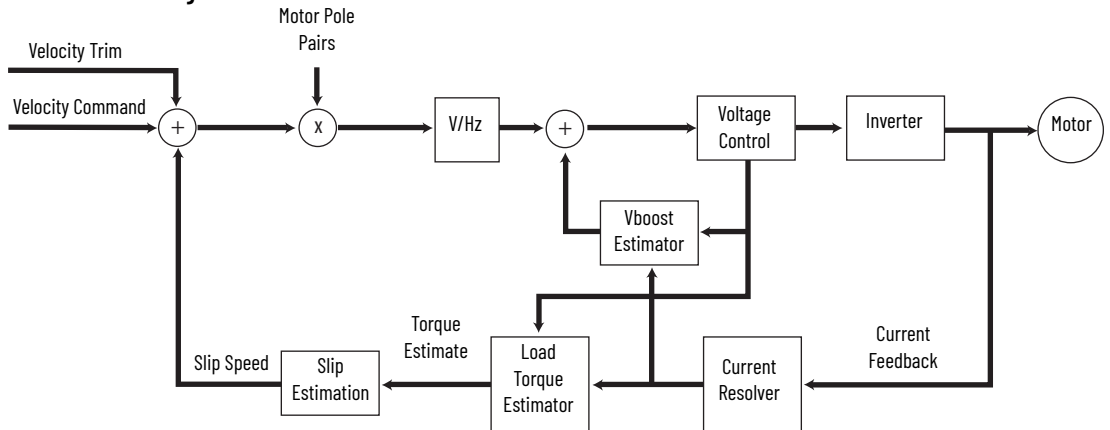

The algorithms operate on the knowledge of the relationship between the rated slip and torque of the motor. The drive uses applied voltages and measured currents to estimate operating slip-frequency. You can enter values to identify the motor resistance value or you can run a motor test to identify the motor resistance value (see [Motor Tests and Autotune Procedure](#) on page 214). Motor nameplate data and test results are ways to accurately estimate the required boost voltage.

The sensorless vector method offers better torque production and speed regulation over a wider speed range than basic volts/hertz.

Dynamic boost is applied internally to compensate voltage drop and improve starting torque.

**Figure 98 - Approximate Load Curve**

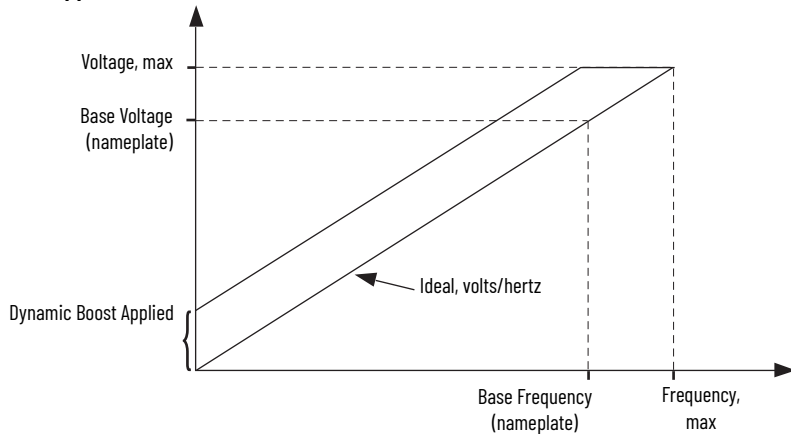

# Current Limiting for Frequency Control

The current limiting module prevents the OutputCurrent value from exceeding the OperativeCurrentLimit value when the drive is configured in Frequency Control mode.

Figure 99 - Current Limiting Module

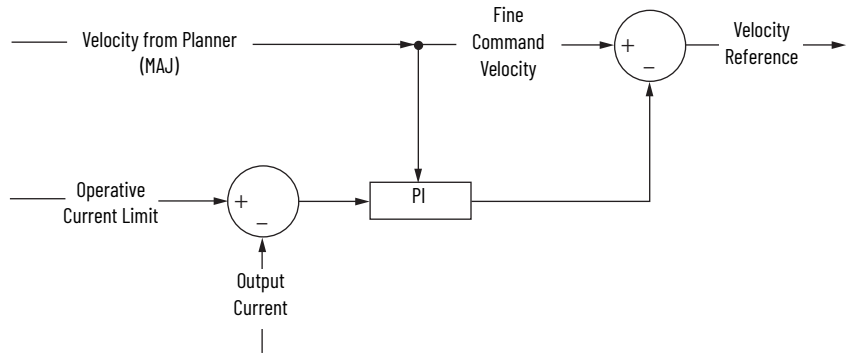

In Frequency Control mode, the OperativeCurrentLimit is the minimum value of the motor-thermal current limit, inverter-thermal current limit, motor-peak current limit, drive-peak current limit, and the CurrentVectorLimit value.

## The Effects of Current Limiting

Indirect current limiting is available for induction motors that are configured for frequency control. You can use this feature to help prevent overcurrent faults due to aggressive acceleration/deceleration profiles or impact loads. The Current Limiting attribute uses a PI regulator to control the OutputCurrent by adjusting the velocity reference.

**IMPORTANT** When configured for Frequency Control (induction motors only), select the Decel and disable stopping action only when the Current Limiting feature is enabled.

Figure 100 - Effects of Current Limiting on an Aggressive Acceleration

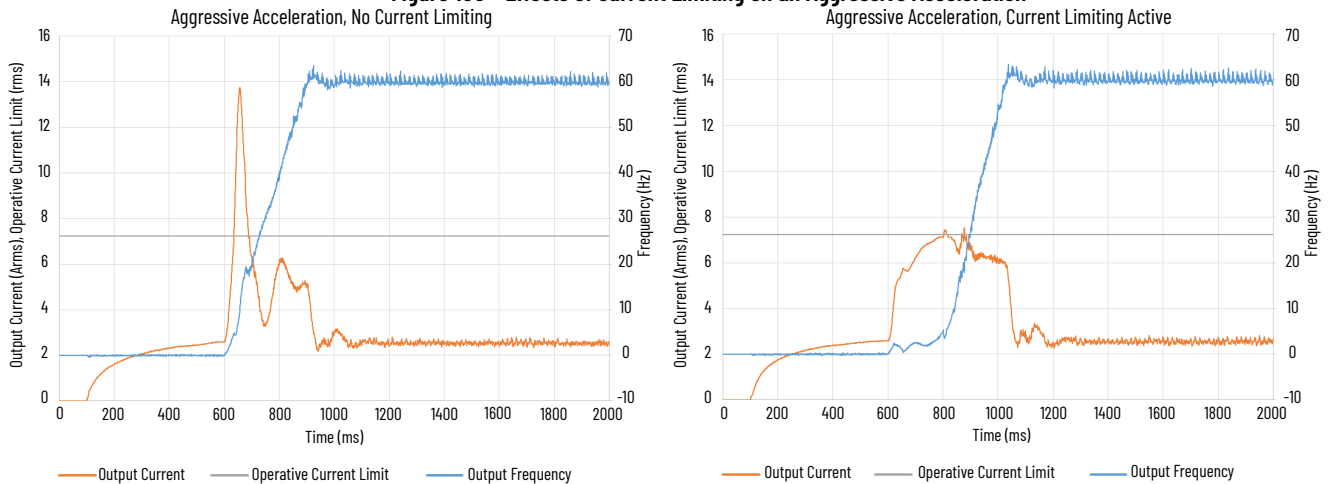
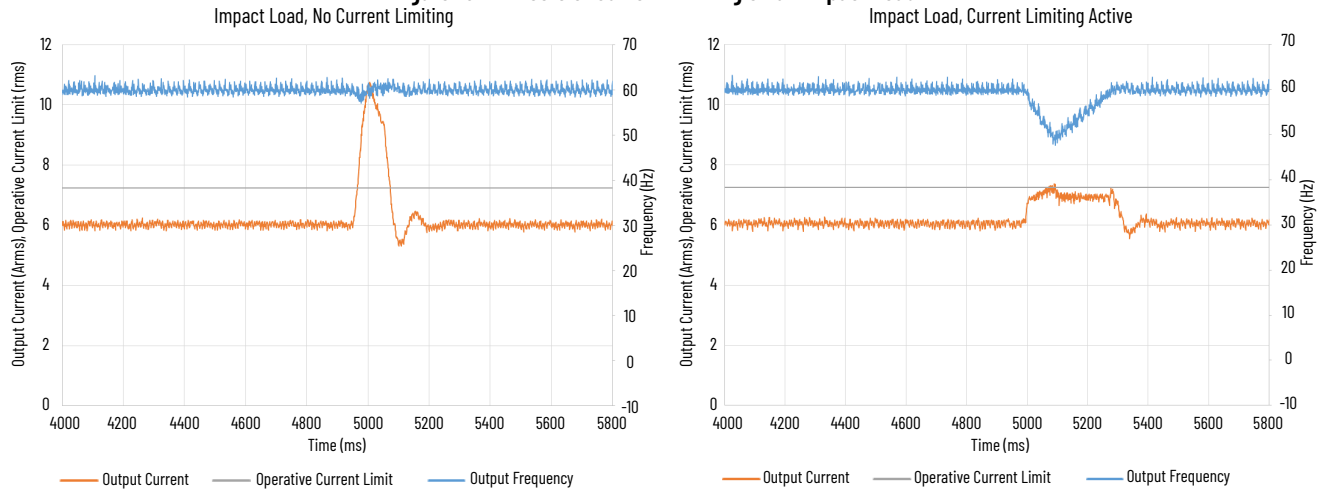

Figure 101 - Effects of Current Limiting on an Impact Load



Current limiting for frequency control is not enabled by default. You can enable via messaging by using the following device-specific attributes.



We recommend you leave the Kp, Ki, and Kd gains at the default values.

Table 94 - Enable Current Limiting via Messaging

Attribute Offset	Type	Attribute Name	Conditional Implementation	Description
3022	SINT	Current Limiting Enable	Frequency Control Induction Motor only	When enabled, limits the rate of change to the velocity reference during high-current situations for improved current limiting. This feature is only active when executing an MDS command and when configured for Frequency Control. 0 = Current Limiting is disabled 1 = Current Limiting is enabled
3023	REAL	Current Limiting Kd		Derivative gain for the current limiting function. Only functional when configured for Frequency Control and when executing an MDS command. Units of seconds.
3024	REAL	Current Limiting Ki		Integral gain for the current limiting function. Only functional when configured for Frequency Control and when executing an MDS command. Units of: feedback counts / (Amp, inst* Seconds).
3025	REAL	Current Limiting Kp		Proportional gain for the current limiting function. Only functional when configured for Frequency Control and when executing an MDS command. Units of: feedback counts / Amp, inst.

**IMPORTANT** For induction motors greater than 5 Hp, when Current Limiting is enabled we recommended that you also enable the Stability Control feature.

## Enable the Current Limiting Feature

In this example, a Message Configuration (MSG) instruction is configured to set the CurrentLimitingEnable attribute. The Instance field is used to direct the message to the proper axis. For single-axis inverters, the value of 1 is used in the Instance field.

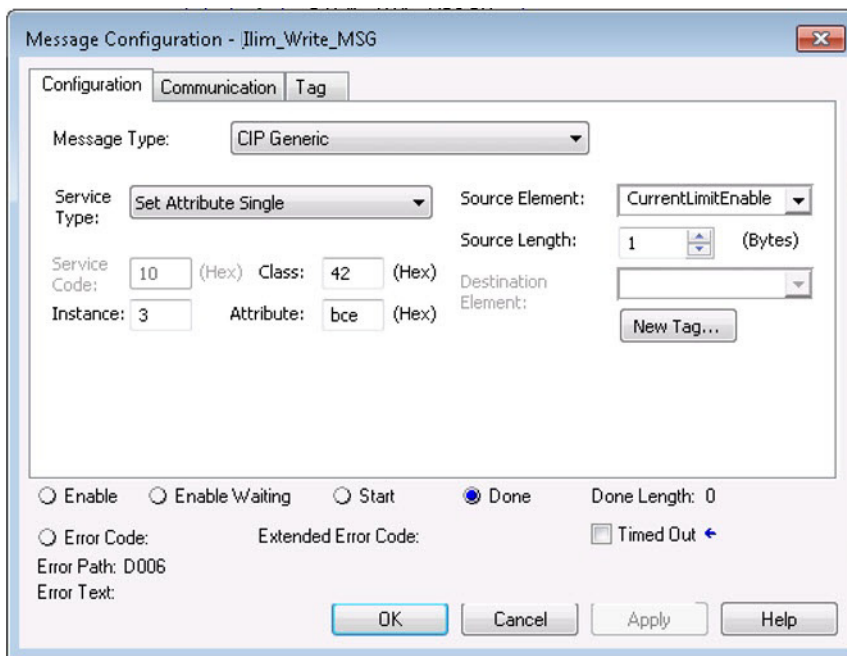

## Set the CurrentVectorLimit Attribute Value

For current limiting, the CurrentVectorLimit attribute is used to help determine the OperativeCurrentLimit of the drive. Set the CurrentVectorLimit value to artificially lower OperativeCurrentLimit below the drive or motor peak current limits.

1. Select the Parameter List category and scroll to CurrentVectorLimit.

CoastingTimeLimit	0.0 s
ConversionConstant	1000000.0 Motion Counts/Position Units
CurrentVectorLimit	100.0 % Motor Rated
FluxUpControl	No Delay
FluxUpTime	0.0 s

2. Set the CurrentVectorLimit value appropriate for your application.

## Stability Control for Frequency Control

Stability control is available for induction motors that are configured for frequency control. This feature can be used to help remove resonances that are sometimes seen on larger motors. The stability control feature adjusts the OutputFrequency and OutputVoltage commands to stabilize the OutputCurrent.

**Figure 102 - Effects of Stability Control**

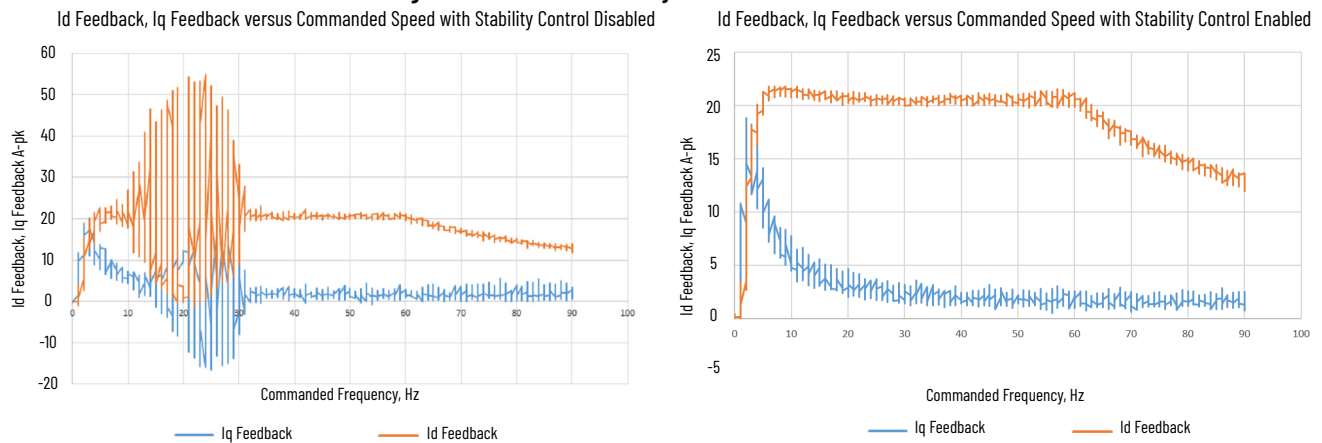

Stability control for frequency control is not enabled by default. You can enable via messaging by using the following device-specific attributes.



We recommend you leave the angle, voltage gains, and filter bandwidth at the default values.

**Table 95 - Enable Current Limiting via Messaging**

Attribute Offset	Type	Attribute Name	Conditional Implementation	Description
3026	SINT	Stability Control Enable	Frequency Control Induction Motor only	Enables stability control when configured for frequency control. 0 = Stability Control is disabled 1 = Stability Control is enabled
3027	REAL	Stability Filter Bandwidth		Sets the bandwidth of the low-pass filter that is applied to the current feedback signal. This bandwidth is common to both the angle and voltage stability control algorithms. Units of radians/second.
3028	REAL	Stability Voltage Gain		The gain of the voltage stability control function. Only active when configured for frequency control. Units of: Volt (inst, p-n)/Amp (inst).
3029	REAL	Stability Angle Gain		The gain of the electrical angle stability control function. Only active when configured for frequency control. Units of: radians/Amp (inst).

**IMPORTANT** Because the stability control feature works by manipulating the OutputVoltage and OutputFrequency signals, these signals can appear 'noisy' when the feature is enabled.

## Enable the Stability Control Feature

In this example, a Message Configuration (MSG) instruction is configured to enable the StabilityControl attribute. The Instance field is used to direct the message to the proper axis. For single-axis inverters, the value of 1 is used in the Instance field.

The screenshot shows the 'Message Configuration - Stab\_Write\_MSG' dialog box. It has three tabs: 'Configuration', 'Communication', and 'Tag'. The 'Configuration' tab is active. The 'Message Type' is set to 'CIP Generic'. The 'Service Type' is 'Set Attribute Single'. The 'Source Element' is 'StabilityControlEnab'. The 'Source Length' is 1 (Bytes). The 'Service Code' is 10 (Hex), 'Class' is 42 (Hex), and 'Instance' is 3. The 'Attribute' is 'bd2' (Hex). The 'Destination Element' is empty, with a 'New Tag...' button below it. At the bottom, there are radio buttons for 'Enable', 'Enable Waiting', 'Start', and 'Done' (which is selected). There are also fields for 'Error Code', 'Extended Error Code', and a 'Timed Out' checkbox. The 'Error Path' is 'D006' and 'Error Text' is empty. Buttons for 'OK', 'Cancel', 'Apply', and 'Help' are at the bottom right.

Field	Value
Message Type	CIP Generic
Service Type	Set Attribute Single
Source Element	StabilityControlEnab
Source Length	1 (Bytes)
Service Code	10 (Hex)
Class	42 (Hex)
Instance	3
Attribute	bd2 (Hex)
Destination Element	
Done Length	0
Timed Out	<input type="checkbox"/>
Error Path	D006
Error Text	

## Skip Speeds

Some machines have a resonant operating frequency (vibration speed) that is undesirable or could cause equipment damage. To guard against continuous operation at one or more resonant points, you can configure the Skip Speed attributes in the Logix Designer application > Axis Properties > Parameter List category.

The value that is programmed into the SkipSpeed1 or SkipSpeed2 attribute sets the central speed of a Skip Speed band within which the drive does not operate. The SkipSpeedBand attribute determines the width of the band. The range is split, half above and half below the SkipSpeed $x$  attribute. Any command setpoint within this band is adjusted by the Skip Speed feature to fall at either the upper or lower Skip Speed band boundary value. The Skip Speed feature contains hysteresis (25% of the SkipSpeedBand value) to prevent frequent switching of VelocityReference.

**Figure 103 - Single Skip Speed Example**

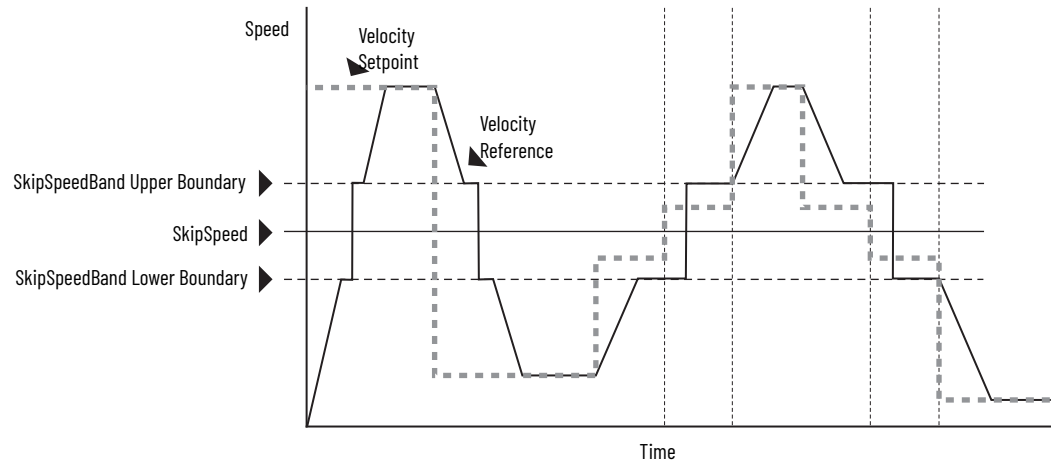

A SkipSpeedBand value of 0 disables the Skip Speed feature.

---

**IMPORTANT** If you want there to be only one SkipSpeed value, the SkipSpeed1 and SkipSpeed2 settings must be the same.

---



---

**IMPORTANT** The Skip Speed feature affects acceleration and deceleration. Too large of a SkipSpeedBand value can result in an overcurrent drive fault.

---



---

**IMPORTANT** The MaximumFrequency attribute is always enforced. Skip Speed band boundary values beyond the MaximumFrequency value do not apply.

---

## Multiple Skip Speeds

The Kinetix 5300 drives feature two independent Skip Speed attributes (SkipSpeed1 and SkipSpeed2) that use the same SkipSpeedBand.

Figure 104 - Multiple Skip Speed Example

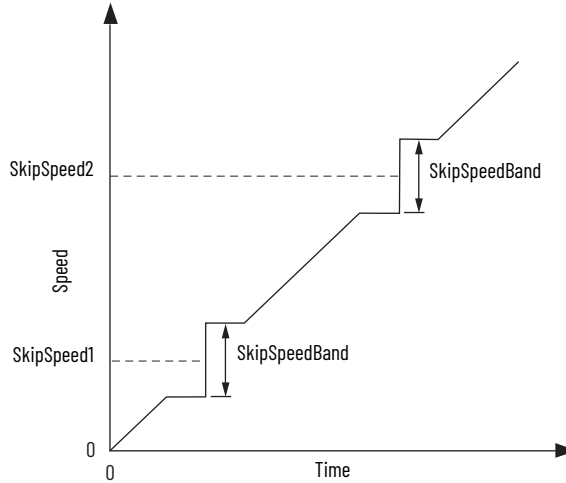

When Skip Speed band boundaries of SkipSpeed1 and SkipSpeed2 overlap, the Skip Speed hysteresis is calculated using the effective skip band.

In [Figure 105](#), SkipSpeed1 is set to 0 and SkipSpeed2 is set to 15 Hz. The skip band is 10 Hz wide.

At point A, the axis is enabled, and the motor begins to rotate at -5 Hz even though the command is 0 Hz. As the command reaches hysteresis point the output frequency begins to follow the command. During deceleration, when the command decreases to 0 Hz, the output frequency continues at 5 Hz until the axis is disabled (point B), or the command is changed outside of the skip band.

Figure 105 - Zero-speed Skip Frequency

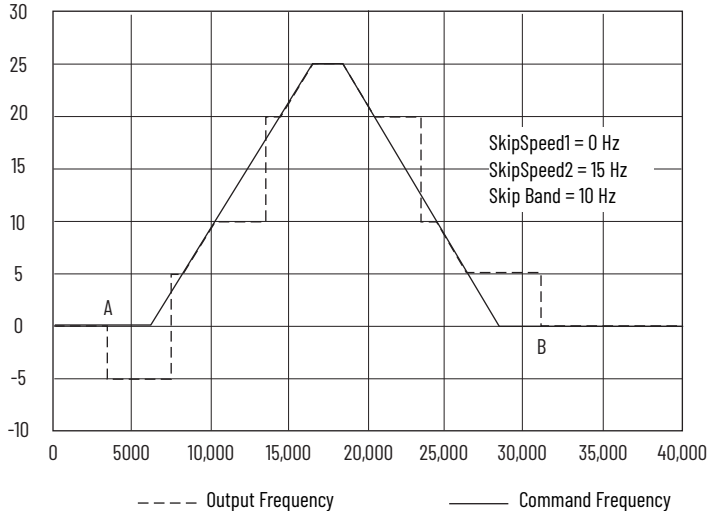



## Flux Up

AC induction motors require that flux builds in the motor stator before controlled torque can develop. To build flux, voltage is applied. There are two methods to flux the motor and three configurable FluxUpControl settings.

With the No Delay setting (normal start), flux is established when the output voltage and frequency are applied to the motor. While flux is building, the unpredictable nature of the developed torque can cause the rotor to oscillate even though acceleration of the load can occur. In the motor, the acceleration profile does not follow the commanded acceleration profile due to the lack of developed torque.

**Figure 106 - Acceleration Profile during Normal Start - No Flux Up**

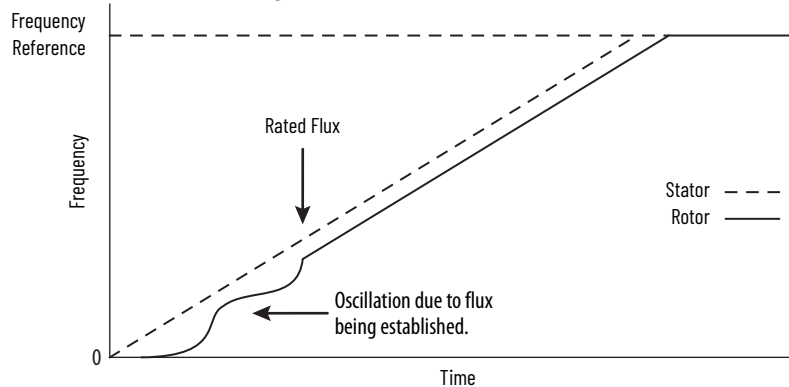

With the Automatic setting (default), DC current is applied to the motor so that flux builds before rotation. The flux-up time period is based on the level of flux-up current and the rotor time constant of the motor. The flux-up current is not adjustable.

In the Manual setting, DC current is applied to the motor so that flux builds before rotation. The FluxUpTime attribute determines the flux-up time period. The flux-up current is not adjustable.

**Figure 107 - Flux Up Current Versus Flux Up Time**

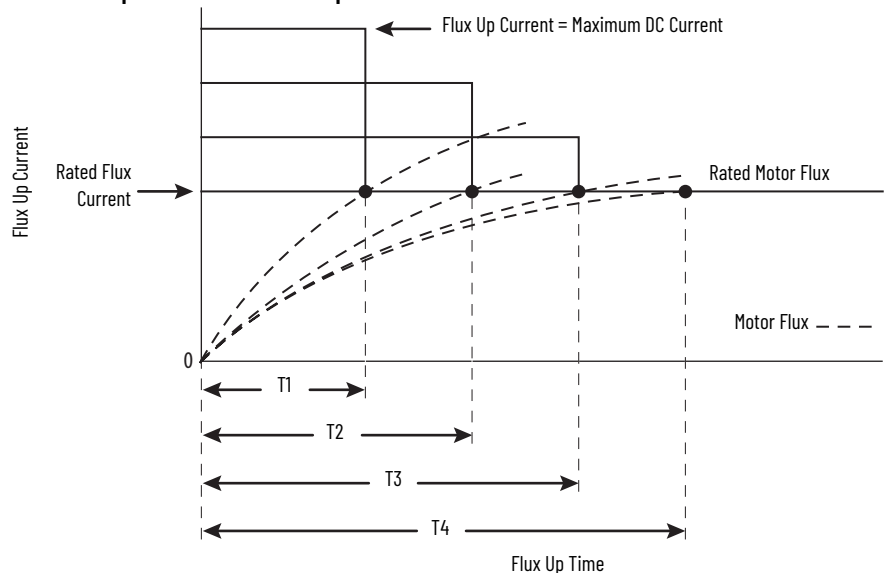

Once rated flux is reached in the motor, normal operation can begin and the desired acceleration profile achieved.

Figure 108 - Rated Flux Reached

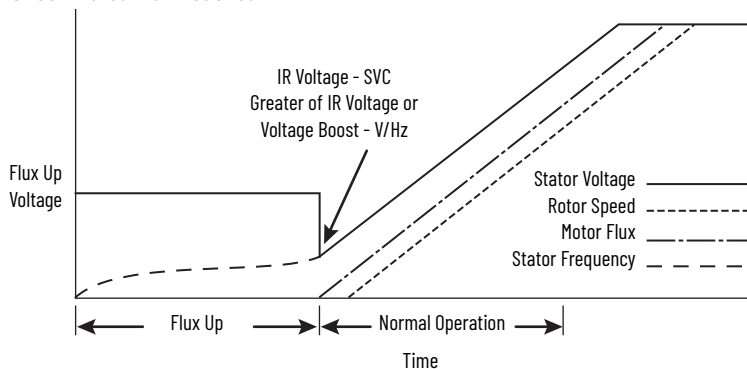

### Flux Up Attributes

ID	Access	Attribute	Conditional Implementation
558	Set	Flux Up Control	Ind Motor only 0 = No Delay 1 = Manual Delay 2 = Automatic Delay
559	Set	Flux Up Time <sup>(1)</sup>	Ind Motor only Units: Seconds Default: 0.0000 Min/Max: 0.0000 / 1000.00

(1) The Flux Up Time is the time that is designated for the Manual Delay setting. This attribute is not supported by the Automatic delay method. The Flux Up feature is disabled if FluxUpControl is set to Manual Delay and FluxUpTime is set to 0.

#### FluxUpControl Attribute

When the motion axis is enabled, DC current is applied to an induction motor to build stator flux before transitioning to the Running state. This attribute controls how an induction motor is to be fluxed in the Starting state before transitioning to the Running state.

Table 96 - FluxUp Control Delay Methods

Delay Method	Description
No delay	The axis transitions immediately to the Running state while the motor flux is building.
Manual delay	The axis remains in the Starting state while the motor stator flux is building according to the Flux Up Time attribute.
Automatic delay	The drive determines the amount of delay time to fully flux the motor based on the motor configuration attribute data or measurements.

#### FluxUpTime Attribute

When FluxUpControl is configured for Manual Delay, this attribute sets the length of delay time to fully flux the motor before transitioning to the Running state.

## Configure the Flux Up Attributes

Follow these steps to configure the flux-up attributes.

1. In the Controller Organizer, right-click an axis and choose Properties.
2. Select the Parameter List category and scroll to FluxUpControl.

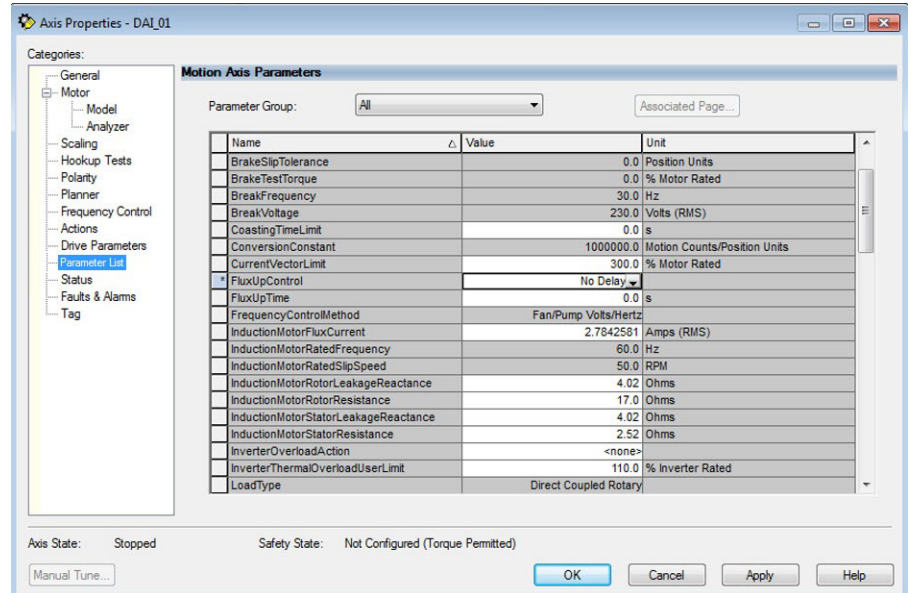

3. From the FluxUpControl pull-down menu, choose the proper delay value appropriate for your application.

CurrentVectorLimit	300.0
FluxUpControl	No Delay
FluxUpTime	No Delay
FrequencyControlMethod	Manual Delay
InductionMotorFluxCurrent	Automatic Delay

4. If you chose Manual Delay in [step 3](#), enter a value in the FluxUpTime attribute appropriate for your application.  
If you chose No Delay or Automatic Delay in [step 3](#), the FluxUpTime attribute does not apply.

# Current Regulator Loop Settings

Current loop bandwidth is set differently based on the selected motor type.  
**Table 97 - Current Regulator Loop Settings**

Motor Type	Default Torque/Current Loop Bandwidth Hz
Rotary permanent magnet	1000
Rotary interior permanent magnet	
Linear permanent magnet	
Rotary induction	400

**IMPORTANT** The Logix Designer application does not perform calculations when the Torque/Current Loop Bandwidth attribute is updated. This bandwidth affects many other gains and limits. Changing (lowering) the torque loop bandwidth without updating all dependent attributes can result in drive/motor instability.

# Motor Category

From the Motor category, you can enter motor nameplate or data sheet values (phase-to-phase parameters) for rotary induction motors.

In this example, the Motor category > Nameplate / Datasheet parameters, were taken from a typical motor performance data sheet. Max Speed and Peak Current values are typically application-dependent.

**Figure 109 - Motor Nameplate / Data Sheet Example**

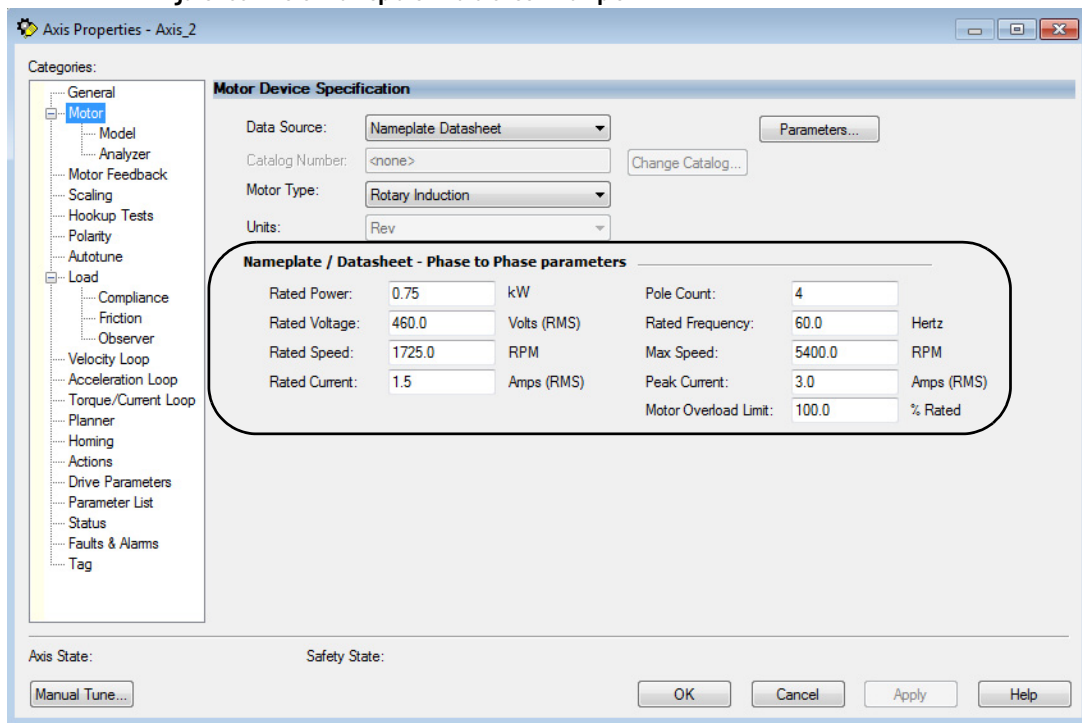

See [Figure 110](#) for a motor manufacturer performance data sheet example.

**Figure 110 - Motor Manufacturer Performance Data Sheet**  
CERTIFICATION DATA SHEET

TYPICAL MOTOR PERFORMANCE DATA

HP	kW	SYNC. RPM	F.L. RPM	FRAME	ENCLOSURE	KVA CODE	DESIGN							
1	.75	1800	1725	56C	TENV	P	A							
PH	Hz	VOLTS	FL AMPS	START TYPE	DUTY	INSL	S.F.	AMB°C	ELEVATION					
3	60	460	1.5	INVERTER ONLY	CONTINUOUS	F3	1.0	40	3300					
FULL LOAD EFF: 84		3/4 LOAD EFF: 82.5		1/2 LOAD EFF: 78.5		GTD. EFF	ELEC. TYPE	NO LOAD AMPS						
FULL LOAD PF: 75		3/4 LOAD PF: 65.5		1/2 LOAD PF: 51		81.5	SQ CAGE INV DUTY	1						
F.L. TORQUE		LOCKED ROTOR AMPS		L.R. TORQUE		B.D. TORQUE		F.L. RISE°C						
3 LB-FT		30 / 15		10.8 LB-FT 360%		15 LB-FT 500%		65						
SOUND PRESSURE @ 3 FT.		SOUND POWER		ROTOR WK ^2		MAX. WK ^2		SAFE STALL TIME		STARTS / HOUR	APPROX. MOTOR WGT			
62 dBA		72 dBA		0.11 LB-FT^2		0 LB-FT^2		0 SEC.		0	42 LBS.			
EQUIVALENT WYE CKT. PARAMETERS (OHMS PER PHASE)														
R1			R2			X1			X2			XM		
8.378			5.6232			10.7068			9.9116			278.036		
RM			ZREF			XR			TD			TD0		
11132.8			284			1.7			0.0071			0.136		

*Motor > Model Category*

From the Motor > Model category, you can enter additional motor nameplate or datasheet values (phase-to-neutral parameters) for induction motors.

The Motor > Model parameters are used in closed-loop induction-motor control mode, sensorless vector control mode, and when FluxUp is enabled. The Motor > Model parameters are estimated automatically by the Logix Designer application based on the motor nameplate data. You can also enter these parameter values directly from the motor nameplate/datasheet or indirectly by running a Motor > Analyzer test.

**Figure 111 - Phase-to-Neutral Parameters**

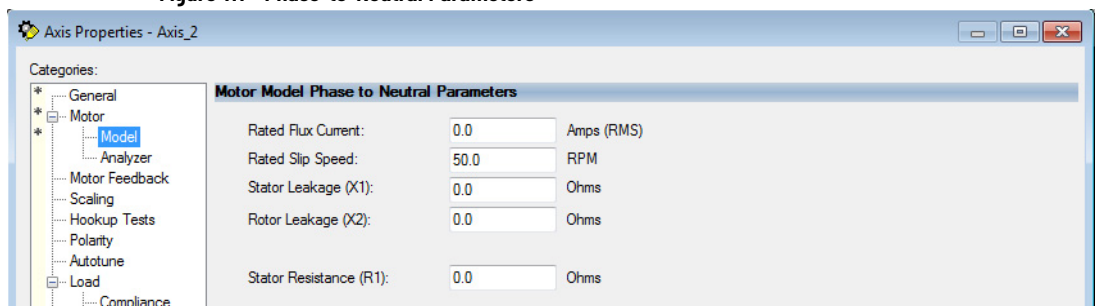

**IMPORTANT** If you do not know the Stator Leakage, Rotor Leakage, Stator Resistance, Rated Flux Current, and system inertia, you can run the static motor test and Autotune procedure to determine the parameter values.

### Motor > Analyzer Category

From the Motor > Analyzer category, you can perform three types of tests to identify motor parameters.

In this example, the Calculate Model test was run. If the Motor > Analyzer test executes successfully, and you accept the test values, they populate the Model Parameter attributes.

Figure 112 - Motor Analyzer Category

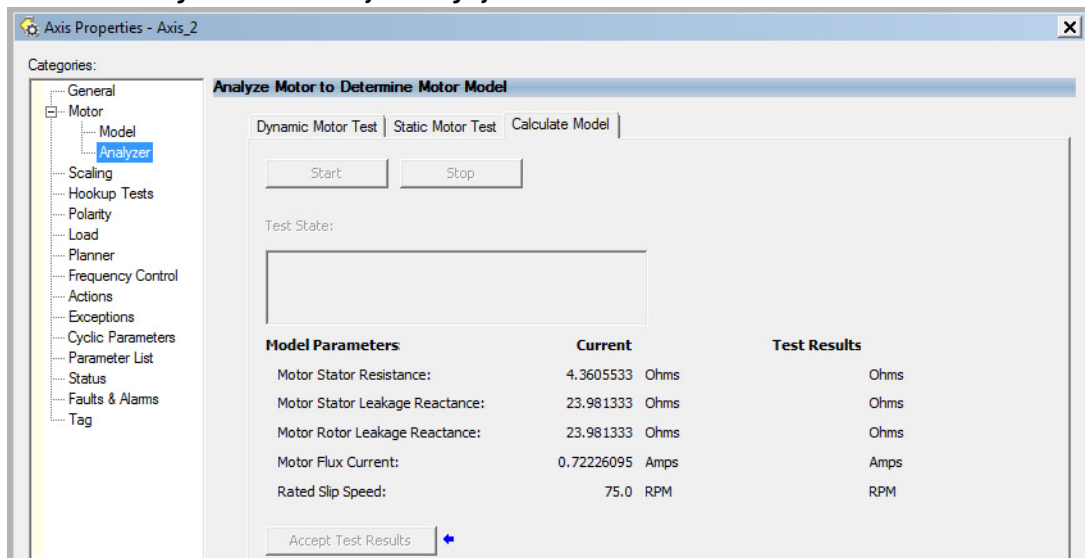

## Motor Tests and Autotune Procedure

You can perform three types of tests to identify motor parameters and one test for motor/system inertia. These parameters are used by sensorless-vector frequency-control and induction motor closed-loop modes. [Table 98](#) recommends which test to use based on the control mode and application.

Table 98 - Motor Tests and Autotune Matrix

Control Mode	Description	Calculate	Static	Dynamic	Autotune (inertia test)
Induction motor - Frequency control	Basic volts/hertz	Not required	Not required	Not required	Not required
	Basic volts/hertz for Fan/Pump	Not required	Not required	Not required	Not required
	Sensorless vector	Required <sup>(1)</sup>	Preferred	Not required	Not required
Induction motor - Closed-loop control		Required <sup>(1)</sup>	Preferred <sup>(2)</sup>	Preferred	Required <sup>(1)(3)</sup>

- (1) Not required for the Logix Designer application, version 29.00 and later.
- (2) If it is not desired to rotate the motor (due to coupled load), you can perform this test for induction motor closed-loop mode and skip the Dynamic test. The dynamic test provides the best results for induction motor closed-loop mode.
- (3) The motor inertia value must be nonzero before running a dynamic test. The motor inertia value is estimated automatically based on the Motor Nameplate data in the Logix Designer application, version 29.00 and later. For previous versions, an Autotune test must be run or the motor inertia value must be entered directly.

The Motor > Analyzer category offers three choices for calculating or measuring electric motor data.

Follow these steps to run motor tests and identify motor parameters.

1. In the Controller Organizer, right-click an axis and choose Properties.
2. Select the Motor > Analyzer category.

Nameplate data was entered on [page 212](#). The nameplate data must be entered before running the Calculate test.

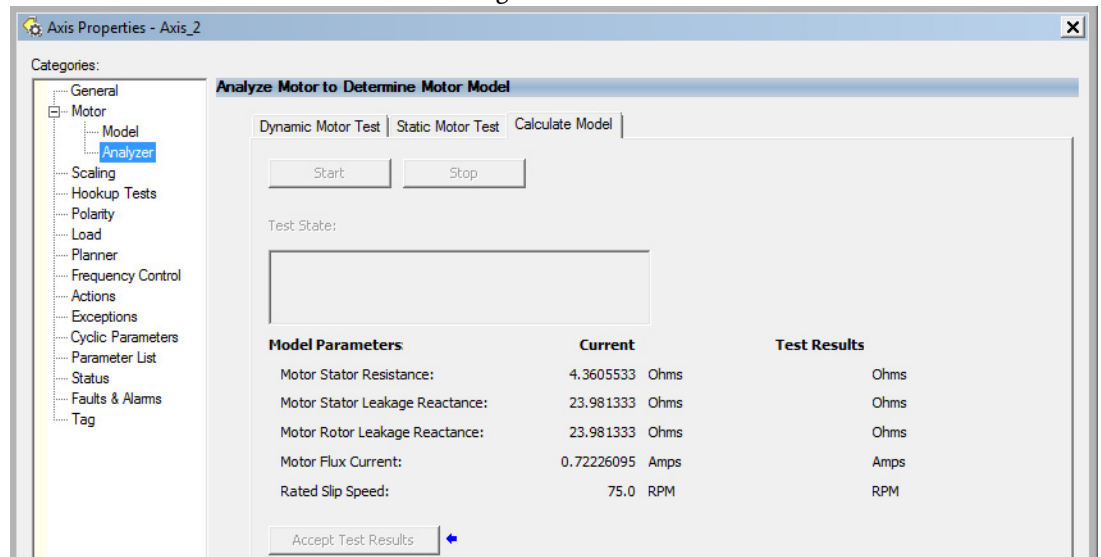

3. Run the test by clicking Start.
4. Save the values by clicking Accept Test Results.
5. Click OK.

## Motor Analyzer Category Troubleshooting

### *Calculate Model*

When a Calculate test is run, the drive uses motor nameplate data to estimate the motor's Rated Flux Current, Stator Resistance ( $R_s$ ), Stator Leakage Reactance ( $X_1$ ) and Rotor Leakage Reactance ( $X_2$ ). The drive also calculates the rated slip speed based on rated speed and rated frequency. No measurements are taken when using the Calculate test.

### *Static Motor Test*

Use the Static test if the motor shaft cannot rotate or if it is already coupled to the load. Only tests that do not create motor movement are run. During this test, the Stator Resistance ( $R_s$ ), Stator Leakage Reactance ( $X_1$ ), and Rotor Leakage Reactance ( $X_2$ ) values are measured during a series of static tests. The Rated Flux Current is estimated, since measurement of this value requires motor movement. The drive also calculates the rated slip speed based on rated speed and rated frequency.

The Static test requires that you enter initial estimates for Rated Flux Current, Rated Slip Speed, Stator Resistance (Rs), Stator Leakage Reactance (X1), and Rotor Leakage Reactance (X2) into the Motor Model fields.

- For the Logix Designer application, version 29.00 or later, the controller populates initial estimates.
- For the Logix Designer application, version 28.00 or earlier, initial estimates can be entered by running and accepting the results of a Calculate test, or by entering the values directly into the Logix Designer application.

### *Dynamic Motor Test*

Dynamic tests are run with the motor disconnected from the load because the motor shaft turns and there are no travel limits. A dynamic test is often the most accurate test method. During this test, the Stator Resistance (Rs), Stator Leakage Reactance (X1) and Rotor Leakage Reactance (X2) values are measured in a series of static tests. The Rated Flux Current is measured during a rotational test, in which the drive commands 75% of the motor rated speed.

The rated slip speed is measured during a second rotational test, in which the drive commands a speed (default of 100% of the motor rated speed) and sets a torque limit (default of 50% of the motor rated torque). This test quickly accelerates the motor to rated speed and then decelerates back to zero speed.

---

**IMPORTANT** The Dynamic test does not support travel limits.

---

The Dynamic test also requires that you enter initial estimates for Rated Flux Current, Rated Slip Speed, Stator Resistance (Rs), Stator Leakage Reactance (X1), and Rotor Leakage Reactance (X2) into the Motor Model fields.

- For the Logix Designer application, version 29.00 or later, initial estimates are automatically populated by the controller.
- For the Logix Designer application, version 28.00 or earlier, initial estimates can be entered by running and accepting the results of a Calculate test, or by entering the values directly into the Logix Designer application.

The Dynamic test uses the Ramp Acceleration and Ramp Deceleration attributes to set the rotational test ramp-up and ramp-down times. If the resulting acceleration/deceleration times are less than 10 seconds, 10 seconds is used. If these attributes are not supported, 10 seconds is also used.

The Dynamic test also uses the IM Slip Test Velocity Command (percent of rated speed) and IM Slip Test Torque Limit (percent of rated torque) attributes to define the motion profile for the slip measurement. The default values are 100.0 and 50.0 respectively. The speed command dictates the speed that the motor spins up to and the torque dictates how quickly the motor reaches that speed. In general, A higher speed and lower torque results in a longer acceleration and a more accurate rated slip speed.

However, the dynamic test does not return expected results if the torque limit is set below 30.0.



Table 99 - Slip Test via Messaging

Attribute Offset	Type	Attribute Name	Conditional Implementation	Description
3095	REAL	IM Slip Test Torque Limit	Closed loop induction motor only	Sets positive and negative torque limits for the slip test within the Dynamic motor test (similar to the torque limits in the inertia test). Units are in percent of rated torque.
3096	REAL	IM Slip Test Velocity Command		Sets the velocity command for the slip test within the Dynamic motor test (similar to the velocity command in the inertia test). Units are in percent of motor rated speed.

The Dynamic test requires that the Positive and Negative Torque Limits for the axis are not over-written while the test is in progress. This requirement can be satisfied by making sure that (1) these cyclic attributes are not checked as writable within the Drive Parameters tab of the axis properties and (2) these parameters are not being messaged via an MSG instruction.

When configured for closed-loop control, the Dynamic test requires that an accurate system inertia is set in the Logix Designer application.

- For the Logix Designer application, version 29.00 or later, a default value is automatically populated by the controller.
- For the Logix Designer application, version 28.00 or earlier, initial estimates can be entered by running and accepting the results of an Autotune test, or by entering the motor inertia value directly into the Logix Designer application.

When configured for closed-loop control, the Dynamic test uses the velocity regulator tuning as entered into the Logix Designer application. If the motor is coupled to a load, the velocity regulator tuning may need to be adjusted to make sure that the velocity response is well controlled. The Dynamic test fails if the steady-state velocity feedback is not within a  $\pm 30\%$  tolerance of the commanded velocity.

---

**IMPORTANT** The Dynamic test is not supported in closed-loop Torque Control.

---

If using the Dynamic test in Frequency Control mode, uncouple the motor from any load. If the motor is coupled to a load, the test results may not be valid. In closed-loop control, either a coupled or uncoupled load produces valid results.

## Selection of Motor Thermal Models

The Kinetix 5300 drives contain two motor thermal-overload protection algorithms that you can use to help prevent the motor from overheating.

### Generic Motors

The default thermal model is a generic  $I^2T$  Class 10 overload protection algorithm. This model is active if the `MotorWindingToAmbientResistance` or the `MotorWindingToAmbientCapacitance` values are 0.0. The purpose of this algorithm is to limit the amount of time that a motor is operating with excessive levels of current. The relationship between Motor Overload Factory Limit trip-time and motor output current is shown in [Figure 113](#).

Figure 113 - Motor Overload Curve

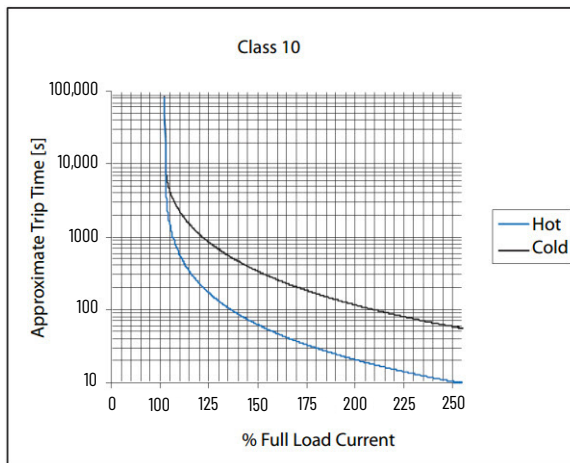

You can use the `MotorOverloadLimit` attribute (default of 100%, max of 200%) to increase the motor overload trip-time by artificially increasing the motor rated current (for thermal protection only). `MotorOverloadLimit` should only be increased above 100% if cooling options are applied. Increasing `MotorOverloadLimit` causes `MotorCapacity` to increase more slowly.

The generic motor thermal model also derates the motor rated current (for thermal protection only) when operating at low speeds. The derating factor is 30% at 0 Hz and 0% at 20 Hz, with linear interpolation between. Operating at output frequencies less than 20 Hz causes `MotorCapacity` to increase more quickly.

When the generic motor thermal-model is active, the `MotorCapacity` attribute increases only if the motor output current is greater than the effective motor rated current (taking into account the `MotorOverloadLimit` and low speed derating factor). The default `MotorThermalOverloadFactoryLimit` and `MotorThermalOverloadUserLimit` values for this thermal model are both 100%.

---

**IMPORTANT** The generic motor-thermal model does not support Current Foldback as a Motor Overload Action.

---

## Rotary Motor Fan Cooling Attribute Information

For motors that are thermally uncharacterized (for example, Kinetix HPK and many third-party motors), the drive uses a generic I<sup>2</sup>T thermal model for motor thermal protection. When using the generic thermal model, the motor's continuous output capacity at low speeds is de-rated to account for an assumed reduction in cooling ability. Motors that are equipped with forced ventilation may not require the de-rated overload protection at low speeds. For this application type, messageable attributes have been added to firmware revisions 13.5 and later. With these attributes, you can adjust the speed threshold at which derating begins and the amount of derating to be applied at zero speed. See [Table 100](#) for attribute information.

**Table 100 - Rotary Motor Fan Cooling Attributes**

Attribute ID	Access	Attribute Name	Data Type	Description	Default Value	Units
2311	Set	Rotary Motor Fan Cooling Speed	REAL	Selects the output speed of the motor below which the motor thermal protection method reduces the threshold that is used to detect an overload condition due to the reduced effectiveness of an integral fan cooling system. A value of zero disables the effect of the attribute. This attribute is only applicable when using the I <sup>2</sup> T motor thermal protection method.	600	RPM
2312	Set	Rotary Motor Fan Cooling Derating	REAL	The attribute value indicates the level of the overload detection threshold at zero speed as a percentage of rated continuous motor current. This attribute is only applicable when using the I <sup>2</sup> T motor thermal protection method.	70	% Motor Rated

### Motor Thermal Overload Plot

[Figure 114](#) shows the default values of the attributes 2311 and 2312 and an example with attributes changed to 200 RPM and 80% respectively.

**Figure 114 - Motor Thermal Overload Threshold Versus Motor Speed**

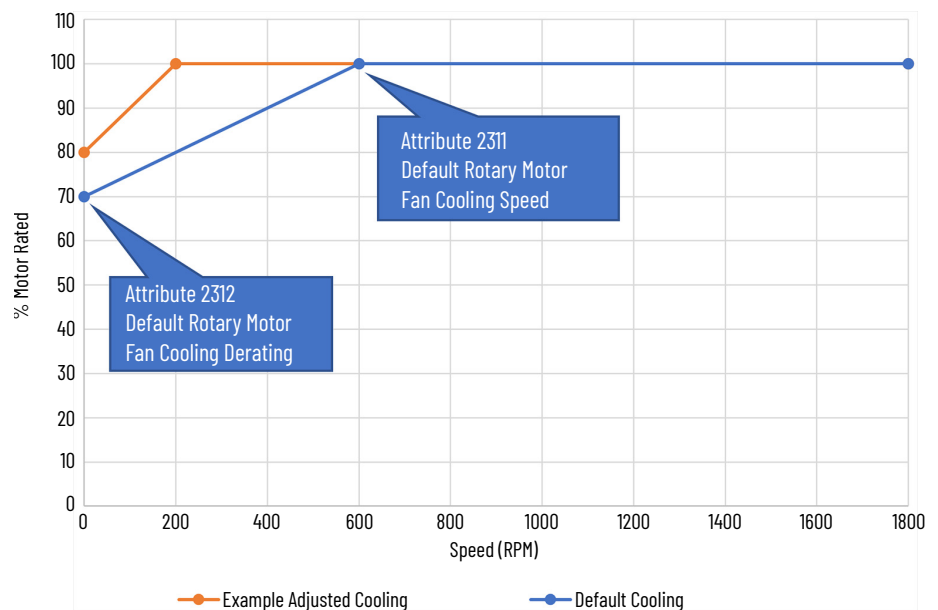

## Thermally Characterized Motors

If the `MotorWindingToAmbientResistance` and `MotorWindingToAmbientCapacitance` attribute values are both nonzero, the motor is considered thermally characterized and an alternate motor thermal model is run. The purpose of this algorithm is to limit the amount of time that a motor is operating with excessive levels of current. This thermal model uses the first-order time constant that is determined from the `MotorWindingToAmbientResistance` and `MotorWindingToAmbientCapacitance` values to estimate the motor thermal capacity based on the motor output current.

The `MotorOverloadLimit` attribute (default of 100%, max of 200%) can be used to increase the motor overload trip-time by increasing the `MotorThermalOverloadFactoryLimit` value. The `MotorOverloadLimit` should be increased above 100% only if cooling options are applied. Increasing `MotorOverloadLimit` does not change the behavior of `MotorCapacity`.

This thermal model supports setting the `MotorOverloadAction` attribute as `Current Foldback`. Selecting the `Current Foldback` action results in a reduction in the current reference via the `MotorThermalCurrentLimit` attribute value that is reduced in proportion the percentage difference between the `MotorCapacity` and the `MotorOverloadLimit` values.

When this thermal model is active, the `MotorCapacity` attribute is nonzero if the motor output current is nonzero. The default `MotorThermalOverloadFactoryLimit` and `MotorThermalOverloadUserLimit` values for this thermal model are both 110%.

---

**IMPORTANT** This thermal model does not derate the motor-rated current when operating at low speeds. Operating at low output frequencies does not cause the `MotorCapacity` behavior to change.

---

## Speed Limited Adjustable Torque (SLAT)

Speed limited adjustable torque (SLAT) is a special mode of operation that is used primarily in web handling applications. While configured for SLAT, the drive typically operates as a torque regulator. The drive can automatically enter velocity regulation based on conditions within the velocity regulator and the magnitude of the velocity regulator's output, relative to the applied TorqueTrim attribute.

A torque regulated application can be described as any process that requires tension control. For example, a winder or unwinder with material being drawn or pulled with a specific tension required. The process also requires that another element set the speed.

When operating as a torque regulator, the motor current is adjusted to achieve the desired torque. If the material that is being wound or unwound breaks, the load decreases dramatically and the motor can potentially go into a runaway condition.

The SLAT feature is used to support applications that require a robust transition from torque regulation to velocity regulation (and vice versa). The SLAT feature can be configured via the SLATConfiguration attribute as:

**Table 101 - SLAT Configuration Descriptions**

Name	Description
SLAT Disable	SLAT function is disabled. Normal Velocity Loop operation.
SLAT Min Speed/Torque	Drive automatically switches from Torque regulation to Velocity regulation if VelocityError < 0 and switches back to Torque regulation if VelocityError > SLATSetPoint for SLATTimeDelay.
SLAT Max Speed/Torque	Drive automatically switches from Torque regulation to Velocity regulation if VelocityError > 0 and switches back to Torque regulation if VelocityError < SLATSetPoint for SLATTimeDelay.

Direction of the applied torque and direction of the material movement determine whether SLAT minimum or SLAT maximum mode should be used.

## Motion Polarity Setting

The Motion Polarity setting in the Logix Designer application > Axis Properties > Polarity does not affect SLAT behavior. However, you may require clarification on whether to use the SLAT Min Speed/Torque or SLAT Max Speed/Torque configuration when Motion Polarity is set to Inverted. In this case, the velocity error that is displayed in the Logix Designer application is inverted compared to what is actually used by the axis to control the SLAT function. So, if the SLAT configuration is set to Min and then Motion Polarity is switched to Inverted, change the SLAT configuration to Max.

**Table 102 - SLAT Operation When Motion Polarity Is Inverted**

Velocity Command	Motion Polarity	SLAT Configuration
Positive (clockwise)	Normal	Min
	Inverted	Max
Negative (counterclockwise)	Normal	Min
	Inverted	Max

## SLAT Min Speed/Torque

SLAT Min Speed/Torque is a special mode of operation that is primarily used in web handling applications. The drive typically operates as a torque regulator, if the TorqueTrim attribute is less than the torque output due to the velocity regulator's control effort. The drive can automatically enter velocity regulation based on conditions within the velocity regulator and the magnitude of the velocity regulator's output relative to the torque reference.

When used for SLAT control, an application-dependent VelocityCommand value is applied to the drive via an MAJ instruction or MDS instruction. An application-dependent TorqueTrim value is also applied via cyclic write. Under normal operation, VelocityCommand is set to a level that results in the velocity regulator's control effort becoming saturated when the motor's speed is mechanically limited. The TorqueReference value equals the TorqueTrim value, resulting in a positive VelocityError value.

If the mechanical speed limitation is removed (example: web break), the motor accelerates and VelocityError becomes negative. At this time, a forced transition to velocity regulation occurs, and the motor's speed is regulated to the VelocityCommand attribute.

The axis remains in velocity regulation until VelocityError exceeds SLATSetPoint for a time that is specified by SLATTimeDelay. At this point, the axis returns to operating as a torque regulator.

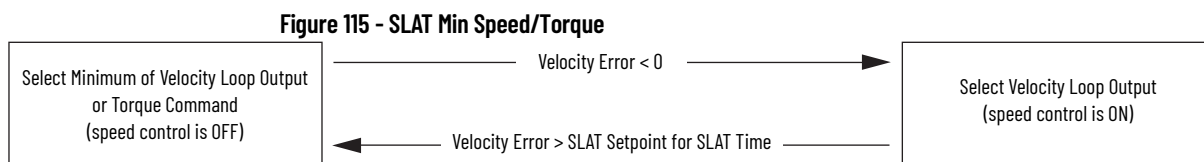

See the Integrated Motion on the EtherNet/IP™ Network Reference Manual, publication [MOTION-RM003](#), for more information on SLAT attributes.

## SLAT Max Speed/Torque

SLAT Max Speed/Torque is a special mode of operation that is primarily used in web handling applications. The drive typically operates as a torque regulator, if the TorqueTrim attribute is greater than the torque output due to the velocity regulator's control effort. The drive can automatically enter velocity regulation based on conditions within the velocity regulator and the magnitude of the velocity regulator's output relative to the torque reference.

When used for SLAT control, an application-dependent VelocityCommand value is applied to the drive via an MAJ instruction or MDS instruction. An application-dependent TorqueTrim value is also applied via cyclic write. Under normal operation, VelocityCommand is set to a level that results in the velocity regulator's control effort becoming saturated when the motor's speed is mechanically limited. The TorqueReference value equals the TorqueTrim value, resulting in a negative VelocityError value.

If the mechanical speed limitation is removed (example: web break), the motor accelerates and VelocityError becomes positive. At this time, a forced transition to velocity regulation occurs, and the motor's speed is regulated to the VelocityCommand attribute.

The axis remains in velocity regulation until VelocityError is less than SLATSetPoint for a time specified by SLATTimeDelay. At this point, the axis returns to operating as a torque regulator.

Figure 116 - SLAT Max Speed/Torque

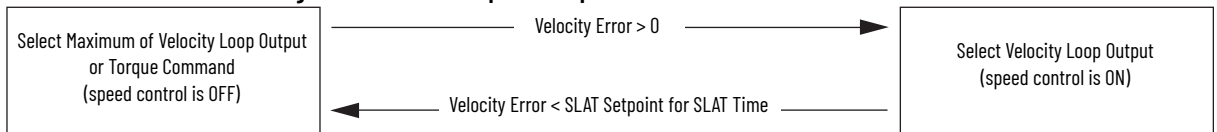

See the Integrated Motion on the EtherNet/IP Network Reference Manual, publication [MOTION-RM003](#), for more information on SLAT attributes.

### SLAT Attributes

ID	Access	Attribute	Conditional Implementation
833	Set	SLAT Configuration	0 = SLAT Disable <sup>(1)</sup> 1 = SLAT Min Speed/Torque 2 = SLAT Max Speed/Torque
834	Set	SLAT Set Point	Velocity Units
835	Set	SLAT Time Delay	Seconds

(1) SLAT Disable, when viewed in version 28.00 (and earlier) of the Logix Designer application, reads Torque Only.

### Configure the Axis for SLAT

Follow these steps to configure the SLAT attributes.

1. In the Controller Organizer, right-click an axis and choose Properties.
2. Select the General category.

The General dialog box appears.

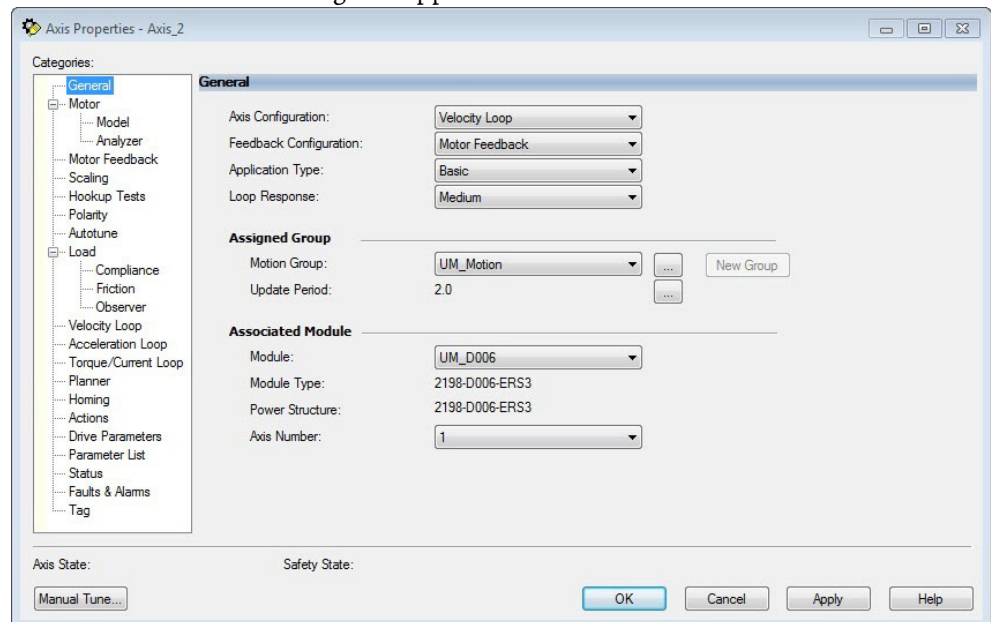

3. From the Axis Configuration pull-down menu, choose Velocity Loop.

The Velocity Loop dialog box appears.

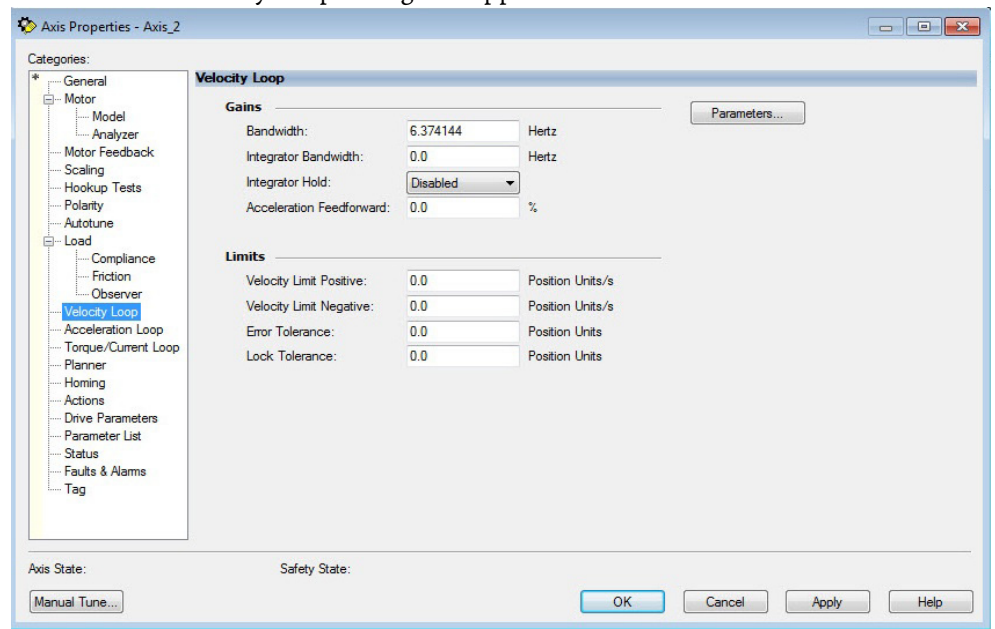

4. Enter values for the Velocity Loop attributes appropriate for your application.
5. Click Apply.
6. Select the Parameters List category.

The Motion Axis Parameters dialog box appears.

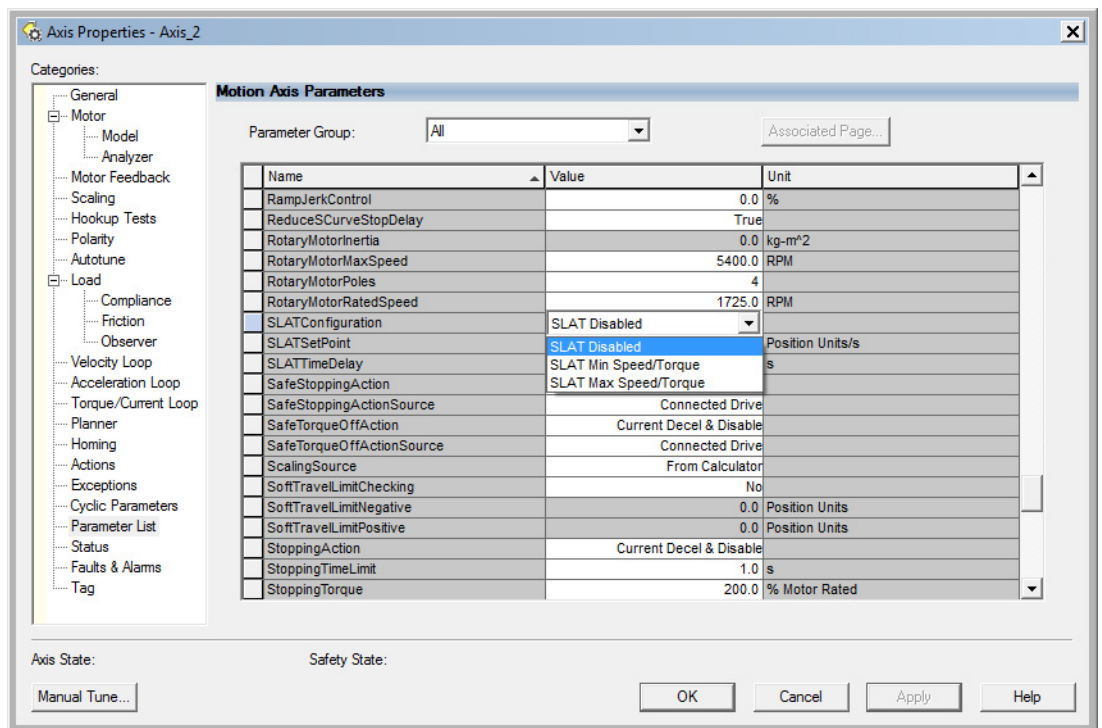

7. From the SLATConfiguration pull-down menu, choose the SLAT configuration appropriate for your application.

**IMPORTANT** SLAT parameters are configurable only when Velocity Loop is chosen from the General category, Axis Configuration pull-down menu.

8. Click Apply.



9. Enter values for SLATSetPoint and SLATTimeDelay attributes appropriate for your application.

SLATConfiguration	SLAT Max Speed/Torque	
SLATSetPoint	0.0	Position Units/s
SLATTimeDelay	0.0	s

10. Click OK.  
11. Select the Drive Parameters category.

The Drive Parameters to Controller Mapping dialog box appears.

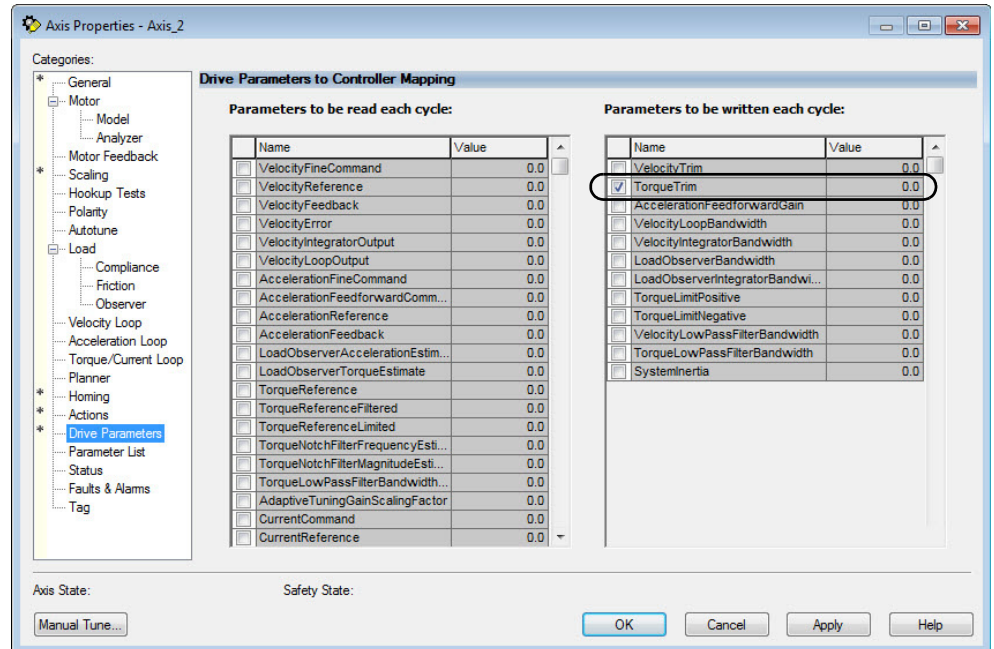

When using SLAT with Kinetix 5300 drives, the velocity command is sent to the drive via an MAJ instruction or MDS instruction. The torque command is sent via the cyclic write TorqueTrim attribute. See the Integrated Motion on the EtherNet/IP Network Reference Manual, publication [MOTION-RM003](#), for more information on cyclic read and cyclic write.

For MAJ instructions:

- When using SLAT, start the axis with the MSO instruction.
- The VelocityCommand is sent via the MAJ instruction.
- The TorqueCommand is sent to AxisTag.TorqueTrim.
- To make changes to the VelocityCommand, you must retrigger the MAJ with the Speed value or use an MCD (motion change dynamics) instruction.
- To stop the axis, use a MAS instruction.
- The axis accelerates and decelerates at the MAJ instruction programmed Acceleration and Deceleration rates.
- You can also change the rates using the MCD instruction.

For MDS instruction:

- When using SLAT, start the axis with an MDS instruction.
- The MDS instruction turns on the power structure enable and tracking command status and also executes the velocity command.  
See sample code in [Motion Drive Start \(MDS\) Instruction](#).
- The acceleration and deceleration rate are controlled by Ramped Acceleration and Ramped Deceleration by using the SSV instruction.
- The Torque Command is set to Axis Tag.Torque Trim. Make sure the Torque Trim Write is checked in the drive parameter (see Drive Parameters dialog box on the previous page). The value can be changed.
  - Alternatively, you can use the Axis Tag.DirectCommandVelocity to alter the Velocity Command when the existing MDS instruction is being executed.

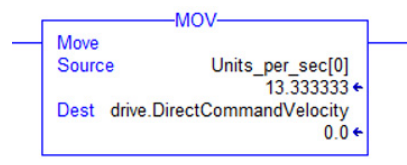

- To stop the axis, use MAS instructions. Keep the Change Decel set to NO and use an SSV instruction to change Ramped Deceleration for the rate you want.

## Motion Drive Start (MDS) Instruction

Use the MDS instruction to activate the drive control loops for the specified axis and run the motor at the specified speed.

For information regarding the MDS instruction, refer to the Logix 5000® Controllers Motion Instructions Reference Manual, publication [MOTION-RM002](#).

For the Kinetix 5300 drive, the MDS instruction is valid only when the axis configuration is set to one of these control modes:

- Frequency Control
- Velocity Loop
- Torque Loop

---

**IMPORTANT** The MDS instruction is not valid when the axis configuration is set to Position Loop.

---

### Motion Drive Start Instruction Configuration

The MDS instruction is configured in a similar fashion to most motion instructions, as seen in this example.

Figure 117 - Typical MDS Instruction

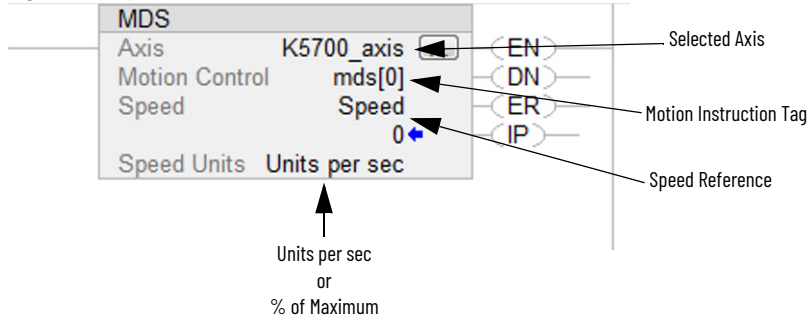

The MDS instruction is similar to a Motion Axis Jog (MAJ) instruction, however, the MDS instruction does not set the acceleration/deceleration rates. The acceleration rate is dynamically set by the ramp attributes configured in a Set System Value (SSV) instruction. See Ramp Attributes on [page 229](#).



The K5300\_Axis was configured for revolutions. Therefore, the Speed Units are revolutions per second (rev/s).

### Motion Drive Start (MDS) Sample Code

Figure 118 - Start

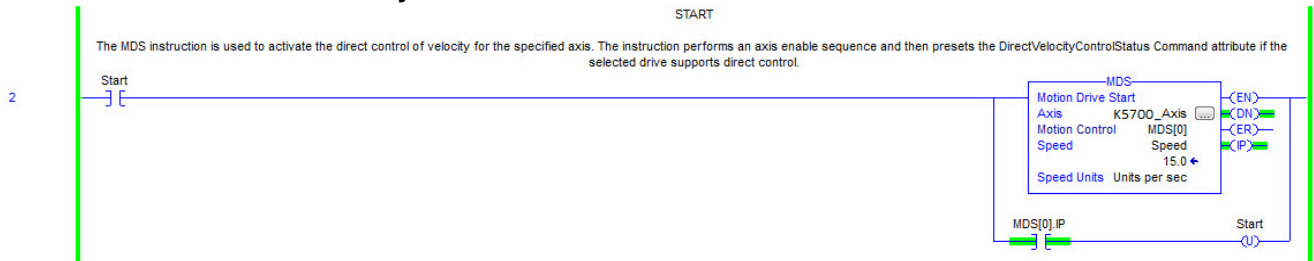

The speed is increased by updating the speed reference and then re-executing the MDS instruction.

Figure 119 - Increase Speed

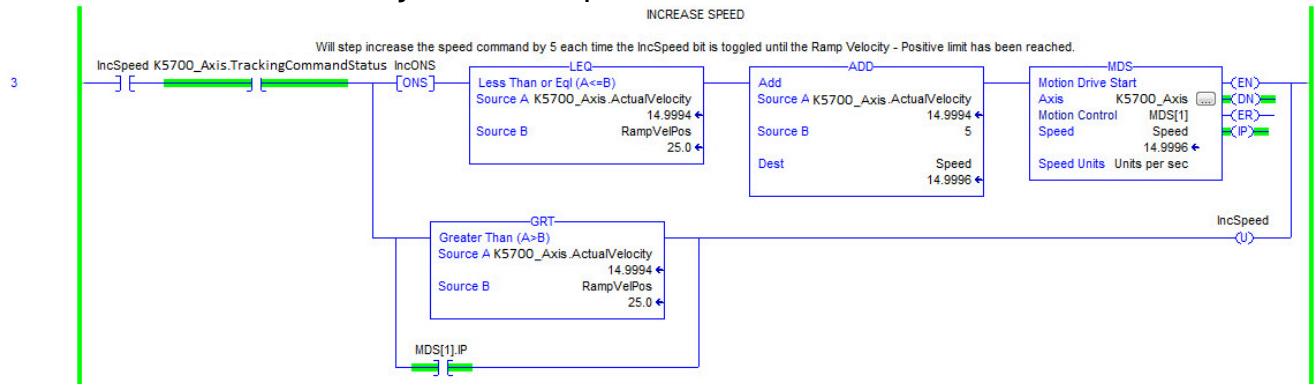

The speed is decreased by updating the speed reference and then re-executing the MDS instruction.

Figure 120 - Decrease Speed

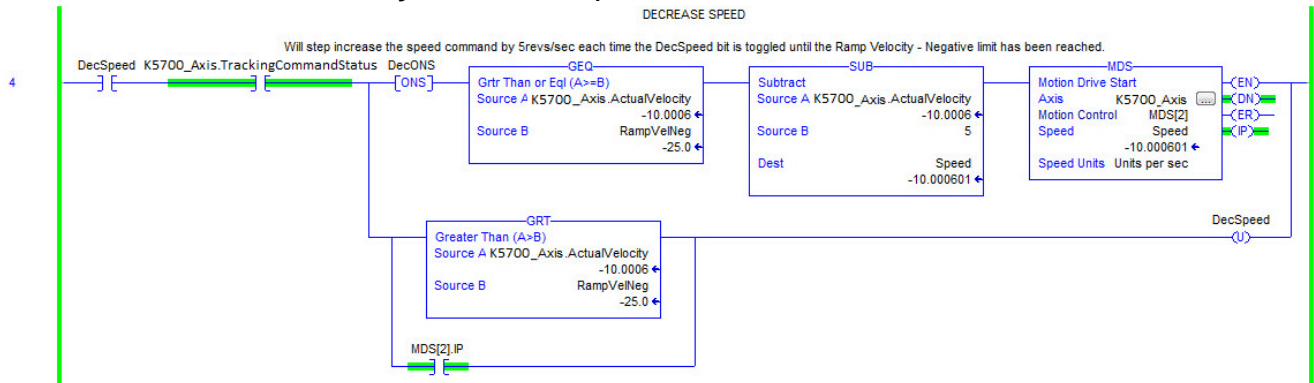

When the axis configuration is in Torque Loop, the Speed attribute within the MDS instruction is not used to command the speed of the drive. The speed is determined by the amount of torque that is specified in the CommandTorque and/or TorqueTrim attributes.

Figure 121 - Torque Mode

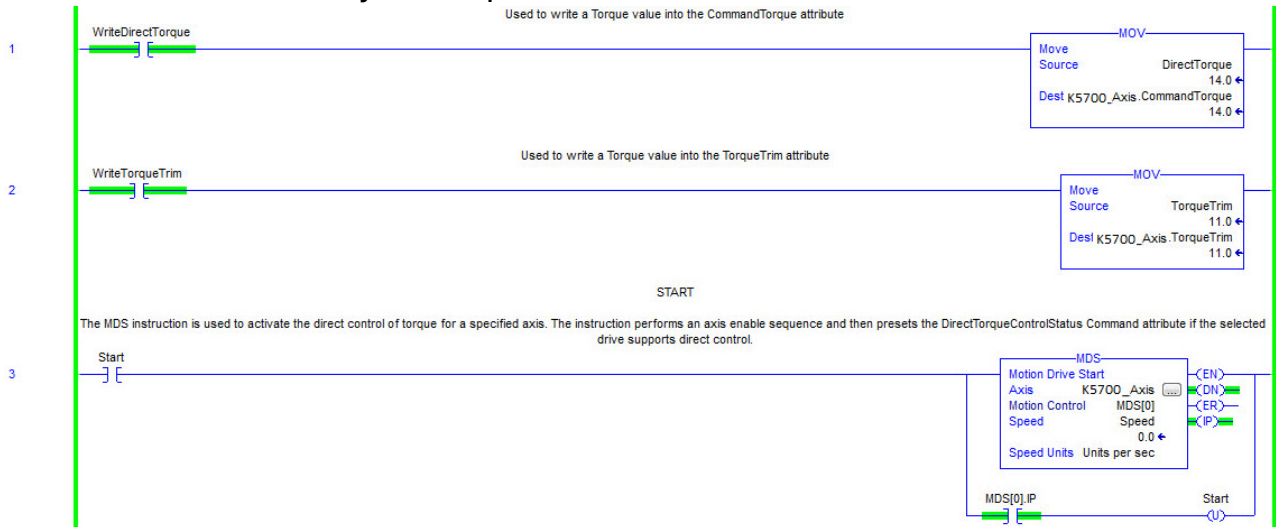

**IMPORTANT** You must command zero torque in the CommandTorque and TorqueTrim attributes before you can use the Motion Axis Stop (MAS) instruction to stop a specific motion process on an axis or to stop the axis completely. To use the MAS instruction, you must set Change Decel to No. Otherwise, an instruction error can occur. The deceleration rate is set based on the Ramp Deceleration attribute. The Motion Servo Off (MSF) instruction is used to deactivate the drive output for the specified axis and to deactivate the axis' servo loop. If you execute an MSF instruction while the axis is moving, the axis coasts to an uncontrolled stop.

## Ramp Attributes

The MDS instruction is validated if the Integrated Motion on EtherNet/IP drive device supports the following five ramp attributes:

- RampAcceleration
- RampDeceleration
- RampVelocity - Positive
- RampVelocity - Negative
- RampJerk - Control

---

**IMPORTANT** Ramp attributes are available only when the Kinetix 5300 drive axis configuration is set to Frequency Control or Velocity Loop. Ramp attributes are not available when the axis configuration is set to Torque Loop or Position Loop.

---

**Table 103 - Ramp Attributes**

Ramp Attribute	Access	ID	Description
RampVelocity - Positive	Set	374	The Ramp Velocity - Positive attribute is a positive value that defines the maximum positive velocity command output of the Ramp Generator.
RampVelocity - Negative	Set	375	The Ramp Velocity - Negative attribute is a negative value that defines the maximum negative velocity command output of the Ramp Generator.
RampAcceleration	Set	376	The RampAcceleration attribute is a positive value that defines the maximum acceleration (increasing speed) of the velocity command output by the Ramp Generator.
RampDeceleration	Set	377	The RampDeceleration attribute is a positive value that defines the maximum deceleration (decreasing speed) of the velocity command output by the Ramp Generator.
RampJerk - Control	Set	379	The RampJerk - Control attribute sets the percentage of acceleration or deceleration time that is applied to the speed ramp as jerk limited S-curve based on a step change in velocity. The S-curve time is added half at the beginning and half at the end of the ramp. A value of 0 results in no S-curve, for example, a linear acceleration or deceleration ramp. A value of 100% results in a triangular acceleration profile with the peak being the configured ramp acceleration or deceleration. As the Jerk Control value increases, the derived accelerating jerk value decreases based on the following: $0.5 \cdot 0.01 \cdot \text{Jerk Control} \cdot \text{Ramp Vel Positive/Ramp Accel}$ . The decelerating Jerk limit value also decreases according to the following: $0.5 \cdot 0.01 \cdot \text{Jerk Control} \cdot \text{Ramp Vel Negative/Ramp Decel}$ .

---

**IMPORTANT** The Ramp attributes can be viewed and set with only an SSV or GSV instruction.

---

Figure 122 - Ramp Attribute Sample Code

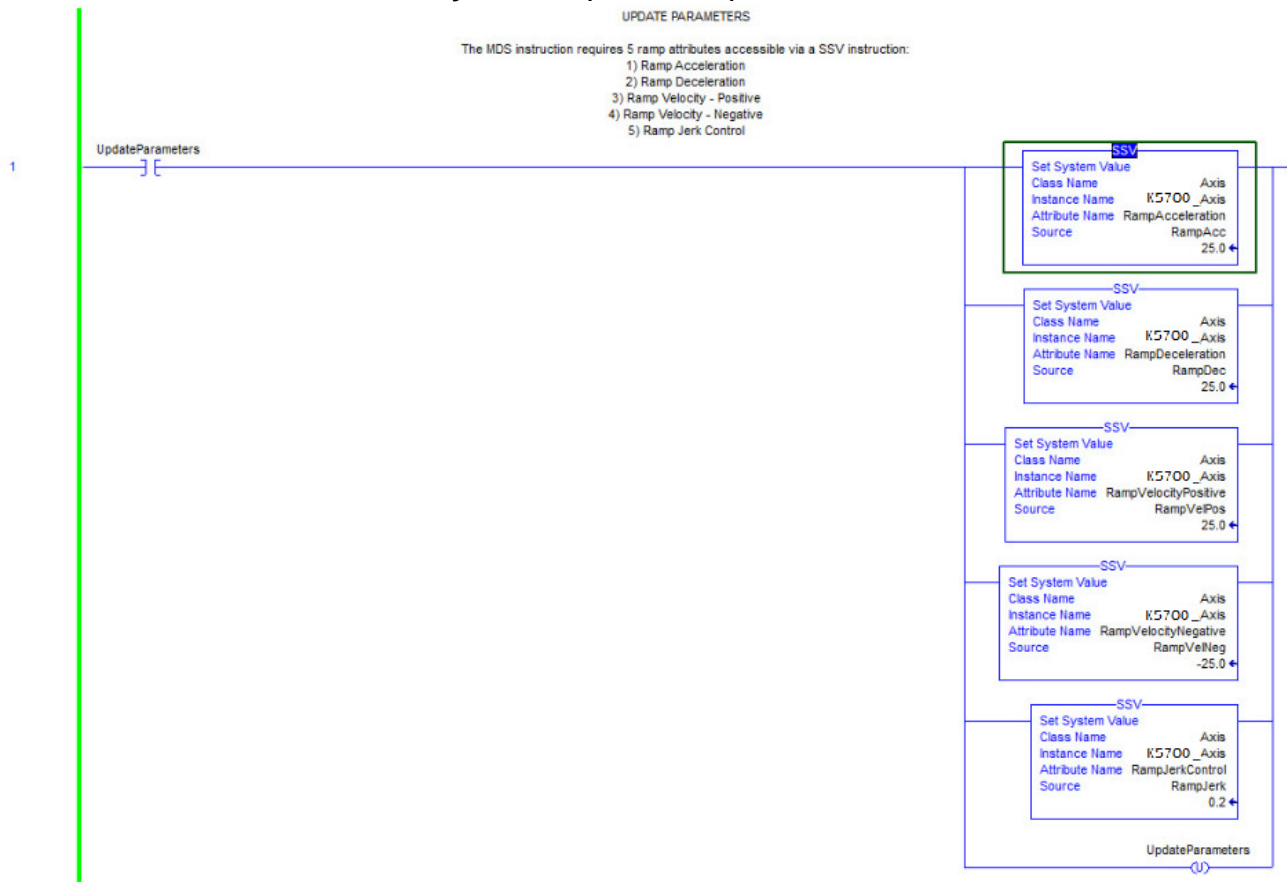

## Motor Overload Retention

The motor overload retention feature protects the motor if there is a drive power-cycle, in which the motor thermal state is lost.

With motor overload retention, upon drive powerup, the MotorCapacity attribute initially reads:

- 20% if the motor is configured to use an integral thermal switch or an integral motor winding temperature is available
- 50% if the motor is not configured to use an integral thermal switch or an integral motor winding temperature is not available

If you have a separate monitoring algorithm within your Logix 5000 controller, you can use the InitialMotorCapacity attribute  $(3075)_{10}$  or  $(C03)_{16}$  to change the initial MotorCapacity value that the motor overload retention feature populates.

- You can write to the InitialMotorCapacity attribute only in the Stopped state after power-up
- You cannot write to the InitialMotorCapacity attribute after the first time the axis is enabled following a power cycle.

Use a message instruction to write to the InitialMotorCapacity value.

In this example, the source element tag motorcapacity is a REAL Data type.

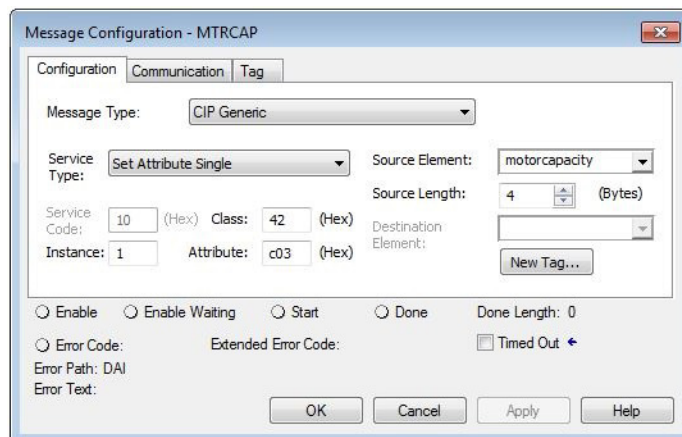

## Phase Loss Detection

The phase-loss detection feature is designed to determine if motor power wiring is electrically connected to a motor and that reasonable current control exists. This attribute enables the operation of the drive's torque proving functions that work in conjunction with mechanical brake control.

When the ProvingConfiguration attribute is enabled, the drive performs a torque prove test of the motor current while in the Starting state to prove that current is properly flowing through each of the motor phases before releasing the brake. If the torque prove test fails, the motor brake stays engaged and an FLT-S09 Motor Phase Loss exception (fault) is generated.

**IMPORTANT** The mechanical brake must be set as soon as the drive is disabled. When the brake is under the control of the axis state machine, the setting of the break is automatic. But, when controlled externally, failure to set the brake when the drive is disabled can cause a free-fall condition on a vertical application.

**Table 104 - Phase-loss Detection Startup Sequence**

Startup Phase	Description
Phase 1	When the drive receives an enable request, the Starting state begins execution and torque proving starts.
Phase 2	The torque proving feature ramps current to the motor-phase output connector and verifies that the current feedback circuitry detects current on each of the phases.
Phase 3	Once motor-current feedback has been verified in each motor phase, the drive attempts to enable the current control loop at a user-specified current level, and verifies that the current-loop error tolerance is within range.

Torque proving is available for all motoring configurations including closed-loop servo control and induction motors.

For permanent magnet (PM) motors, the drive attempts to apply current to the motor phases such that all current through the motor is flux current. However, due to the electrical angle of the motor at the time of the MSO instruction, it may not be possible to verify the motor phase wiring with only flux current. Therefore, with a PM motor it is possible that the motor shaft can move slightly during torque proving if no motor brake exists to hold the load.

**Table 105 - Phase-loss Detection Attributes**

ID	Access	Attribute	Conditional Implementation
590	SSV	ProvingConfiguration	0 = Disabled 1 = Enabled
591	SSV	TorqueProveCurrent	% Motor Rated Units: Amps Default: 0.000 Min/Max: 0/10,000



## Phase-loss Detection Configuration

Follow these steps to configure the phase-loss detection attributes.

1. In the Controller Organizer, right-click an axis and choose Properties.
2. Select the Parameter List category and scroll to ProvingConfiguration.

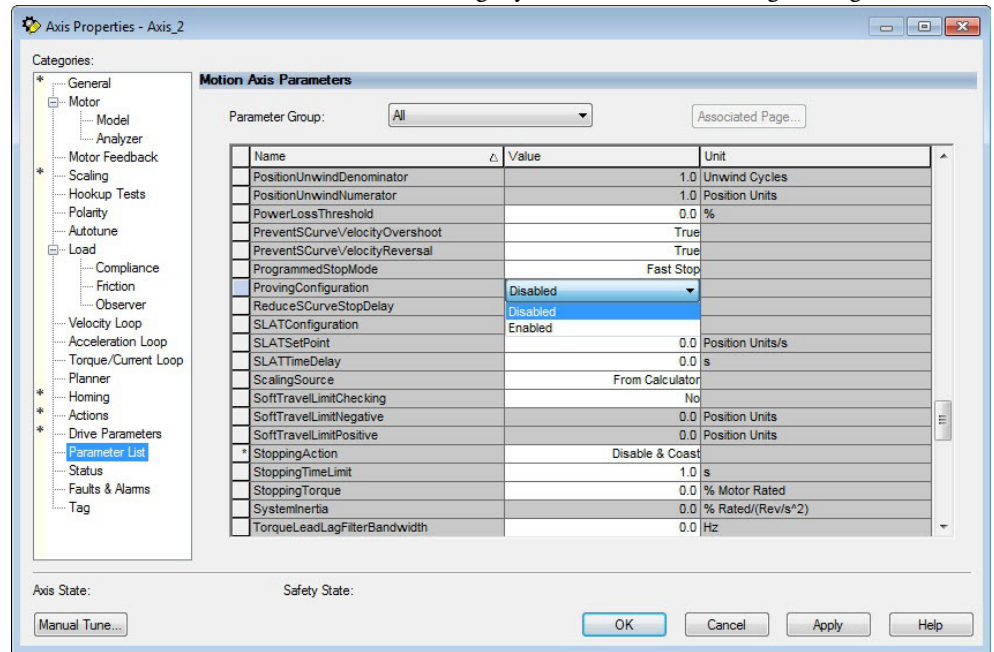

3. From the ProvingConfiguration pull-down menu, choose Enabled to enable the torque proving feature.

Name	Value	Unit
TorqueOffset	0.0	% Motor Rated
TorqueProveCurrent	0.0	% Motor Rated
TorqueRateLimit	1000000.0	% Motor Rated/s

4. Enter a value in the TorqueProveCurrent attribute appropriate for your application.
5. Click OK.

The TorqueProveCurrent attribute is active only if ProvingConfiguration is set to Enabled. TorqueProveCurrent lets you specify the amount of current that is used during the torque proving test and calculated as a percentage of motor rating. The higher the TorqueProveCurrent value the more current the drive delivers to the motor to verify that the motor phase wiring is available and capable of that current level. High current levels conversely cause more thermal stress and (potentially) can cause more torque to be driven against the motor brake during the test. If the TorqueProveCurrent level selected is too small, the drive cannot distinguish the proving current from noise, and in this case the drive posts an INHIBIT Sco4 torque proving configuration fault code. The minimum amount of torque proving current depends on the catalog number of the drive.

## Phase Loss Detection Current Example

In this example, a 2198-C1004-ERS drive is paired with a TLP-A070-020 motor with 1.65 A rms continuous current. Use the phase-loss detection equation and table to calculate the initial minimum torque proving current as a percentage of motor rated current. Depending on the unique characteristics of your application, the required torque proving current value can be larger than the initial recommended value.

**Figure 123 - Phase-loss Detection Equation**

$$\left( \frac{\text{Rating from Table}}{\text{Motor Rated Current}} \right) = \frac{0.203 \text{ A}}{1.65 \text{ A}} = 12.30\% \text{ motor rated current.}$$

**Table 106 - Recommended Phase-loss Detection Current**

Drive Cat. No.	Phase-loss Detection Current, Min A, rms
2198-C1004-ERS	0.203
2198-C1007-ERS	0.330
2198-C1015-ERS	0.610
2198-C1020-ERS	0.879
2198-C2030-ERS	1.407
2198-C2055-ERS	2.891
2198-C2075-ERS	3.430
2198-C4004-ERS	0.117
2198-C4007-ERS	0.208
2198-C4015-ERS	0.376
2198-C4020-ERS	0.523
2198-C4030-ERS	0.838
2198-C4055-ERS	1.626
2198-C4075-ERS	1.976

## Velocity Droop

The velocity droop function can be useful when some level of compliance is required due to rigid mechanical coupling between two motors. The feature is supported when the axis is configured for Frequency Control, Velocity Control, or Position Control.

### Closed Loop Control

The closed-loop velocity droop function is supported when configured for either Velocity or Position control. The velocity error input to the integral term is reduced by a fraction of the velocity regulator's output, as controlled by the VelocityDroop attribute. Therefore, as torque loading on the motor increases, actual motor speed is reduced in proportion to the droop gain. This functionality is helpful when some level of compliance is required due to rigid mechanical coupling between two motors.

---

**IMPORTANT** The closed-loop velocity droop function acts to reduce the velocity error input to the integral term, but never changes the polarity of the velocity error.

---



---

**IMPORTANT** When configured for closed-loop control, the units of the VelocityDroop attribute are Velocity Control Units / Sec / % Rated Torque.

---

## Frequency Control

The velocity droop function is also supported when configured for Frequency Control. As the estimated I<sub>q</sub> current within the motor increases, the velocity reference is reduced in proportion to the VelocityDroop attribute. Therefore, as torque loading on the motor increases, actual motor speed is reduced in proportion to the droop gain. This functionality is helpful when some level of compliance is required due to rigid mechanical coupling between two motors.

**IMPORTANT** The frequency-control velocity droop function acts to reduce the velocity reference, but never changes the direction of the velocity reference.

**IMPORTANT** When configured for frequency control, the units of the VelocityDroop attribute are Velocity Control Units / Sec / % Rated I<sub>q</sub> Current.

## Velocity Droop Attribute

ID	Access	Attribute	Conditional Implementation
464/321	SSV	Velocity Droop	Velocity Units / Sec / % Rated

## Velocity Droop Configuration

Follow these steps to configure the velocity droop attribute.

1. In the Controller Organizer, right-click an axis and choose Properties.
2. Select the Parameter List category and scroll to VelocityDroop.

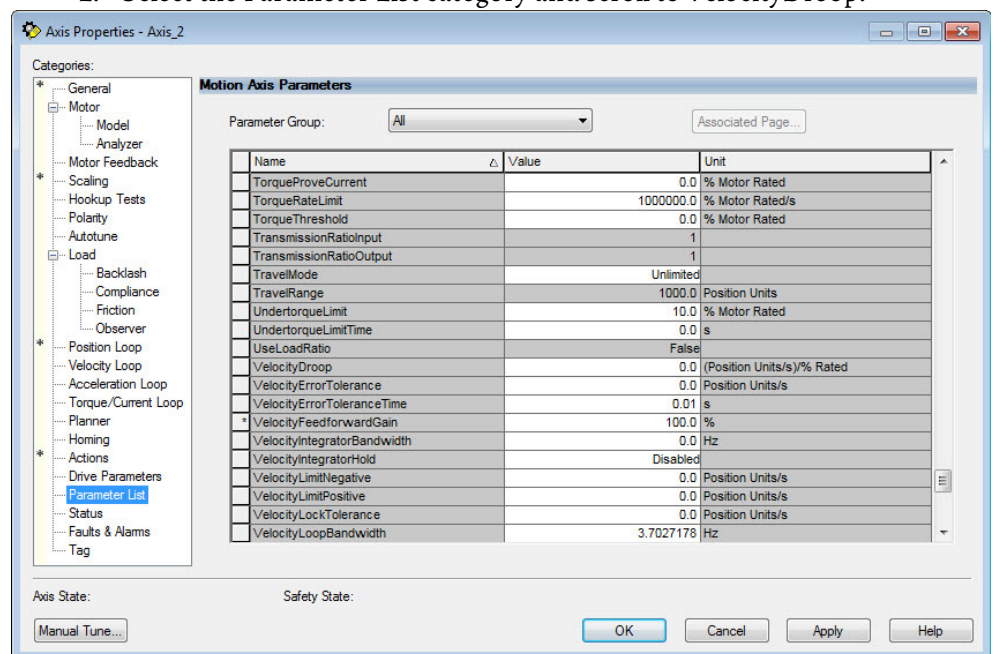

3. Enter a value in the Velocity Droop attribute appropriate for your application.
4. Click OK.

## Commutation Self-sensing Startup

The commutation self-sensing feature is used to determine the initial electrical angle for permanent magnet (PM) motors with an incremental encoder that do not have Hall effect sensors. For PM motors that use encoders with Hall sensors, the drive can still be configured to use this feature, however, the Hall effect signals are ignored. When enabled, this feature is executed automatically at powerup and when the system is enabled.

**IMPORTANT** Following a connection loss to the controller after the initial power-up, the commutation self-sense feature is run again when connection is re-established and motion is commanded.

The self-sense feature takes approximately 5 seconds to execute. 5 seconds is the default amount time, assuming no retries are required. The axis stays in the Starting state while self-sense executes. The sequencing of events is as follows.

1. 1 second current ramp time
2. 1 second delay
3. 1 second move time
4. 1 second delay
5. 1 second current ramp time

**IMPORTANT** Self-sensing startup is not commutation diagnostics. You can perform commutation diagnostics on Hall effect or self-sensing motors at any time.

To use the self-sense feature, select the Motor Feedback category and from the Commutation Alignment pull-down menu, choose Self-Sense.

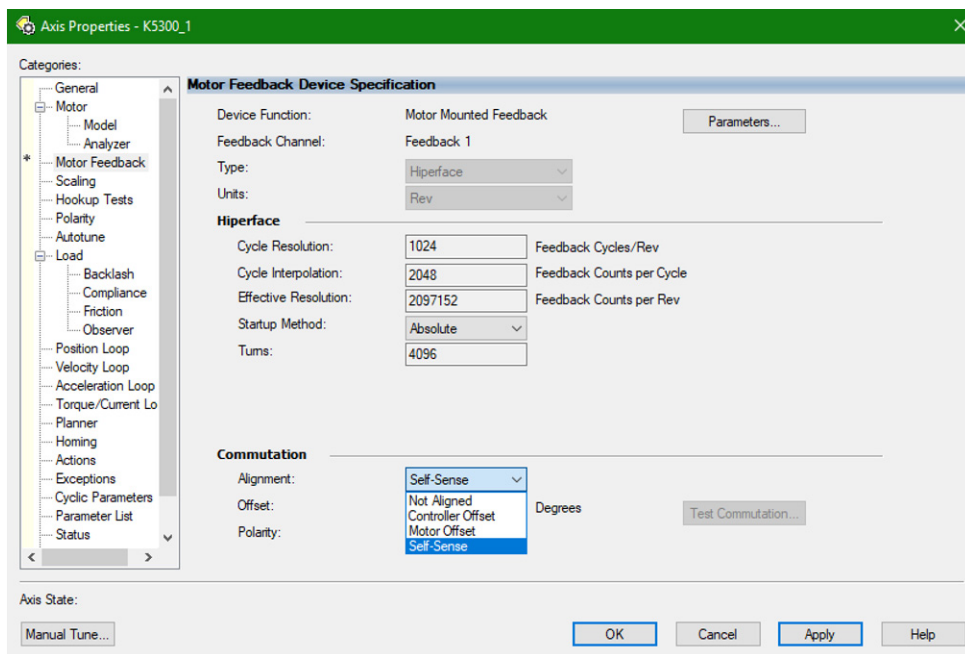

Table 107 - Self-sense Feature Attributes

CIP Attribute Number	CIP Attribute Name	Data Type	Description	Semantics of Values
562	Commutation Self-Sensing Current	REAL	The percent of the motors rated peak current to use for self-sensing startup. This value can be adjusted when the motor is moving a high inertia load.	% Motor Rated Peak Current [default = 100]
3102	Self-Sense Direction	USINT	<ul style="list-style-type: none"> <li>Forward - indicates the motor moves in only the positive direction during self-sensing startup.</li> <li>Negative - indicates the motor moves in only the negative direction during self-sensing startup.</li> </ul>	Enumeration: 0 = Forward - clockwise (rotary) or Positive (linear) [default] 1 = Reverse - counterclockwise (rotary) or Negative (linear)
3103	Self-Sense Lock Time	REAL	The amount of time the drive uses to build up current to the Self-Sensing Current level specified above.	Seconds [default = 1.0]
3104	Self-Sense Lock Delay	REAL	The amount of time the motor must be in the locked position after reaching the full Self-Sensing Current.	Seconds [default = 1.0]
3105	Self-Sense Move Time	REAL	The amount of time the drive uses for the verification move during self-sensing startup. Applies only to motors with self-sensing startup.	Seconds [default = 1.0]
3106	Self-Sense Move Delay	REAL	The amount of time the drive holds the final position after the verification move during self-sensing startup.	Seconds [default = 1.0]

## Commutation Test

The commutation test determines an unknown commutation offset and can also be used to determine the unknown polarity of the start-up commutation wiring. You can also use the commutation test to verify a known commutation offset and the polarity start-up commutation wiring.

---

**IMPORTANT** This test applies to third-party or custom permanent-magnet motors that are equipped with (TTL with Hall and Sine/Cosine with Hall) incremental encoders that are not available as a catalog number in the Motion Database or motors that are compatible with the commutation self-sense startup feature.

---



---

**IMPORTANT** When motors have an unknown commutation offset and are not listed in the Motion Database by catalog number, you cannot enable the axis.

---

Figure 124 - Hookup Tests - Commutation Tab

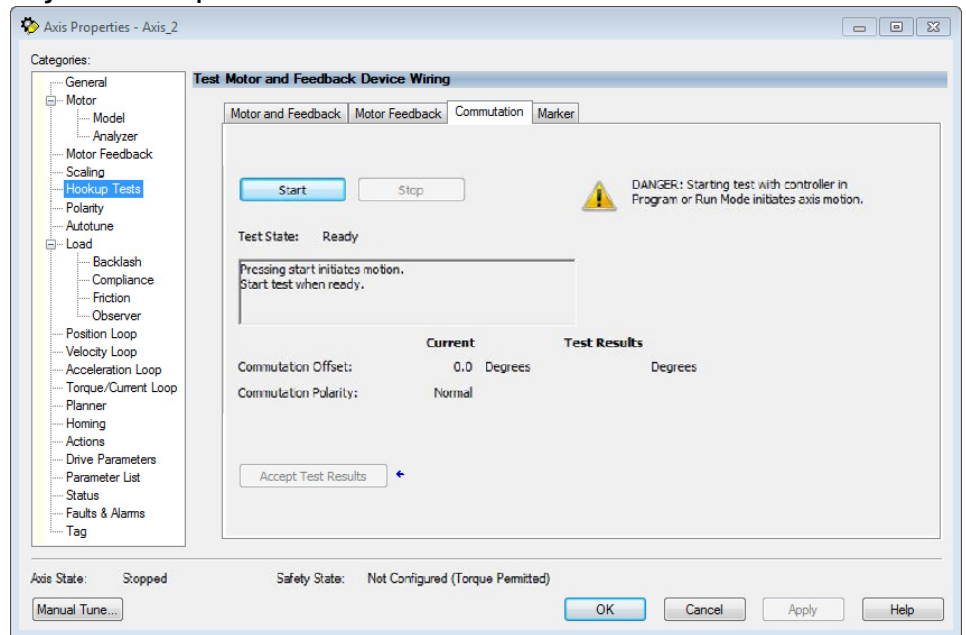

To run the commutation test, see [Test the Axes on page 138](#).

## Adaptive Tuning

The adaptive tuning feature is an algorithm inside the Kinetix 5300 servo drives. The algorithm continuously monitors and, if necessary, adjusts or adapts various filter parameters and, in some cases, control-loop gains to compensate for unknown and changing load conditions while the drive is running. Its primary function is to:

- Automatically adjust torque-loop notch and low-pass filter parameters to suppress resonances
- Automatically adjust control-loop gains to avoid instability when detected

See Motion System Tuning Application Techniques, publication [MOTION-AT005](#), for more information on the AdaptiveTuningConfiguration attribute.

## Virtual Torque Sensor

The virtual torque sensor feature provides an estimate of the motor torque without having a physical torque sensor. The virtual torque sensor can be leveraged to improve the commissioning and maintenance experience with mechanical systems and to optimize production quality. Some examples of how the feature can be applied include the following:

- Indication of shaft misalignment during commissioning
- Verification of appropriate mechanical belt tensioning during maintenance
- Detection of a material jam during operation

The feature provides an estimate of the motor air-gap torque under dynamic and steady state operating conditions. The air-gap torque is the torque that includes the load torque, motor torque losses, and rotor acceleration torque. The estimated torque does not affect motion control or drive performance.

For more information on how to apply the virtual torque sensor feature, see Virtual Torque Sensor Application Technique, publication [2198-AT003](#).

## History of Changes

This appendix contains the new or updated information for each revision of this publication. These lists include substantive updates only and are not intended to reflect all changes. Translated versions are not always available for each revision.

### 2198-UM005C-EN-P

#### 2198-UM005C-EN-P, February 2022

<b>Change</b>
Updated guidance for downloading fault code spreadsheets.
Replaced LDAT-Series with Kinetix® LDAT.
Replaced 2090-Series with Kinetix 2090.
Replaced LDC-Series with Kinetix LDC.
Replaced LDL-Series with Kinetix LDL.
Added 2198-RD006 to Additional Resources table.

**Notes:**



## Numerics

**2090-CFBM7DF-CD** 14, 89  
**2090-XXNFMF** 14, 89  
**2198-DBRxx-F** 14  
**2198-DBxx-F** 14  
**2198-K53CK-D15M** 14, 18, 95  
**24V input power connector**  
 evaluation 29  
 pinouts 53  
 wiring 76

## A

**about this publication** 9  
**absolute position feature** 64  
**AC input power connector**  
 pinouts 53  
 wiring 77  
**AC line filter selection** 26  
**AC line filters**  
 2198-DBRxx-F 14  
 2198-DBxx-F 14  
 noise reduction 38  
**actions category** 125, 130  
**actuator compatibility** 80  
**adaptive tuning** 238  
**additional resources** 10  
**Add-on Profile** 107  
**agency compliance** 24  
**alarm** 145, 146  
**apply power** 137  
**associated axes**  
 category 112, 133  
**audience for this manual** 9  
**auxiliary feedback** 61  
 encoders 62  
 pinouts 54  
 wiring 78  
**axis properties** 116, 118, 122, 128, 134  
**axis unstable** 144

## B

**basic volts/hertz** 119, 199  
**Beldon** 81  
**block diagrams**  
 power 184  
**bonding**  
 EMI (electromagnetic interference) 34  
 examples 35  
 high frequency energy 36  
 subpanels 36  
**brake relay** 56  
**build your own cables** 68  
**bulletin**  
 MPAI electric cylinders 18  
 MPAR electric cylinders 18  
 MPAS linear stages 18

## bus

regulator 114

## C

### cables

build your own cables 68  
 catalog numbers 80, 81, 89  
 categories 38  
 Ethernet cable length 97  
 feedback preparation  
 Kinetix MP 90  
 Kinetix TL/TLY 91  
 Kinetix TLP 90  
 induction motors 81  
 maximum length 82  
 motor power 86  
 preparation  
 Kinetix MP 83  
 Kinetix TL and TLY 86  
 Kinetix TLP 83  
 shield clamp 87, 92

**calculate model** 215

### capacitor module

wiring 96

### catalog numbers

drive accessories 23  
 Kinetix 5300 drives 23  
 motor cables 80, 81, 89  
 shared-bus connection system 23

### category 3

requirements 160  
 stop category definitions 160

### CE

compliance 24

### certification

PL and SIL 160  
 TÜV Rheinland 159  
 user responsibilities 159  
 website 11, 159

### CIP Security

10

### circuit breaker selection

27

### clamp

87, 92

### communication path

configure 191

### commutation

offset 139, 237

self-sensing 236

### CompactLogix

Ethernet connections 97

### compatibility

motors and actuators 80

**configuring**

- actions category 125, 130
- axis properties 134
- basic volts/hertz 119
- communication path 191
- controller 107
- DHCP 103
- digital input 113
- exceptions category 126, 131
- fan/pump volts/hertz 121
- feedback-only axis 113, 116
- flux up 211
- frequency control category 119, 120, 121
- general category 116, 118, 122, 128
- hookup test 139
- induction-motor closed-loop axis properties 128
- induction-motor frequency-control axis 118
- IP settings 103
- Kinetix 5300 drives 110
- load category 125, 131
- master feedback 117
- MDS instruction 227
- module properties 110, 112, 113, 133
- motion group 115
- motor
  - analyzer category 120, 131
  - category 118, 123, 128, 212
  - feedback category 129, 134, 135, 136, 137
  - test 138
- motor feedback device options 122
- network parameters 105
- parameter list category 126
- power properties 114
- scaling category 124, 130
- sensorless vector 119
- SLAT 223
- SPM motor closed-loop axis properties 122
- torque proving 233
- valid feedback types 134
- velocity droop 235
- vertical load 116

**connecting**

- CompactLogix 97
- ControlLogix 97
- converter kit shield clamp 92
- Ethernet cables 97
- motor shield clamp 87

**control power**

- input specifications 58
- pinouts 53
- wiring 76

**ControlFLASH**

- firmware update 191
- troubleshooting 195

**ControlFLASH Plus**

- firmware update 187

**controller**

- and drive behavior 145
- CompactLogix 107
- configure 107
- ControlLogix 107
- properties
  - date/time tab 109
  - enable time synchronization 109

**ControlLogix**

- Ethernet connections 97

**conventions used in this manual 9****converter kit**

- cable preparation
- motor feedback 92

**current limiting 202****current regulator loop 212****D****date/time tab 109****DC bus connector**

- pinouts 53

**DHCP 103****digital encoder**

- AqB TTL 134
- AqB with UVW 135

**digital inputs 56**

- pinouts 54
- wiring 78

**disable 146****download Motion Analyzer 11****drilling hole patterns 44****drive accessories 23****dynamic motor test 216****E****earth ground 71****EMI (electromagnetic interference)**

- bonding 34

**enable time synchronization 109****enclosure**

- power dissipation 32
- requirements 25
- selection 31
- sizing 31

**encoder 62**

- phasing 63

**erratic operation 145****Ethernet connector**

- pinouts 53

**EtherNet/IP**

- connecting cables 97
- connections 58
- PORT1 and PORT2 connectors 97

**exceptions category 126, 131****external shunt resistor 39, 40**

- pinouts 53
- wiring 96

**F****fan/pump 200**

- volts/hertz 121

**fault codes 9, 143, 162**

- status only 146
- summary 142

**features and indicators 52****feedback**

- configurations 18
- feedback-only axis 113, 116
- specifications 59

**firmware update**

- ControlFLASH 191
- ControlFLASH Plus 187
- inhibit the module 186
- system requirements 185
- verify update 195

**flowchart** 102**flux up** 209

- attributes 210

**frequency control category** 119, 120, 121**fuse selection** 27**G****general**

- category 116, 118, 122, 128
- tab 110

**grounded power configuration** 69**grounding**

- multiple subpanels 72

**H****hardwired STO** 22**HF bonding** 34**high frequency energy** 36**hole patterns** 44**hookup test** 139, 237**I****I/O**

- digital inputs specifications 56

**IEC 61508** 160**IEC 62061** 160**ignore** 145, 146**induction motor control** 81

- closed-loop axis properties 128
- configure flux up 211
- control methods
  - basic volts/hertz 199
  - fan/pump 200
  - sensorless vector 201
- flux up 209
  - attributes 210
- frequency-control axis 118
- motor
  - analyzer category 214
  - and inertia tests 214
  - data sheet 213
  - model category 213
  - multiple skip speed 208
  - open-loop frequency control 198, 202, 205
  - skip speed 207
  - SLAT 223

**inhibit the module** 186**input power wiring**

- 24V control 76
- 3-phase WYE 69
- AC 77
- determine input power 69
- grounded power configuration 69
- single-phase 70

**installing drive accessories**

- AC line filters 38
- external shunt resistor 39, 40

**installing your drive** 25

- bonding examples 35
- bonding subpanels 36
- cable categories 38
- circuit breakers 27
- clearance requirements 33
- fuse selection 27
- HF bonding 34
- passive shunts 30
- system mounting requirements 25
- transformer 27

**interconnect diagrams**

- 2198 drive with LDAT 179
- 2198 drive with MPAR/MPAI 181
- 2198 drive with MPAS 180
- 2198 drive with MPL/MPM/MPF/MPS 176
- 2198 drive with TL 178
- 2198 drive with TLP 173, 174, 175
- 2198 drive with TLY 177
- 2198 with LDC 182, 183
- 2198 with LDL 182, 183
- notes 169
- shunt resistor 172
- single-axis drive
  - single-phase 171
  - three-phase 170

**IP settings** 103**ISO 13849-1 CAT 3**

- requirements 160
- stop category definitions 160

**K****Kinetix LDAT** 18**Kinetix LDC** 18**Kinetix LDL** 18**Kinetix MPAI** 18**Kinetix MPAR** 18**Kinetix MPAS** 18**L****Lapp** 81**linear actuators**

- interconnect diagram
- MPAR/MPAI 181

**linear motors**

- LDC 182, 183
- LDL 182, 183

**linear thrusters**

- LDAT 18

**link**

- link/activity status indicator 143
- speed status indicator 143

**load category** 125, 131**Logix Designer application** 106, 107**M****major fault** 145**MAS instruction** 228**master feedback** 117

**maximum cable lengths** 82**MDS instruction**

- configure 226
- decrease speed sample code 228
- increase speed sample code 227
- ramp attributes 229
- ramp attributes sample code 230
- start sample code 227
- torque mode sample code 228

**MFB connector**

- pinouts 55

**minor fault** 145**module properties** 133

- associated axes category 133
- associated axes tab 112
- digital input 113
- general tab 110
- module definition 111
- new tag 113
- power tab 114

**module status indicator** 143**motion**

- drive start instruction 226
- group 115

**Motion Analyzer**

- download 11

**motor**

- accel/decel problems 144
- analyzer category 120, 131, 214
- brake connector
  - pinouts 55
- cable catalog numbers 80, 81, 89
- category 118, 123, 128
- data sheet 213
- feedback
  - category 129, 134, 135, 136, 137
- feedback connector
  - pinouts 55
- feedback device options 122
- induction 81
- interconnect diagram
  - LDAT 179
  - MPAS 180
  - MPL/MPM/MPF/MPS 176
  - TL 178
  - TLP 173, 174, 175
  - TLY 177
- model category 213
- motor and inertia tests 214
- overheating 145
- overload retention 231
- power connector
  - pinouts 54
- power connector pinouts 54
- power wiring 86
- shield clamp wiring 87, 92
- testing 138
- thermal models 218
- tuning 138
- velocity 144

**motor brake connector**

- wiring 79

**motor power connector**

- wiring 79

**mounting your drive**

- attaching to the panel 50
- drilling hole patterns 44
- mounting order 42
- shared-bus connection system 43
- zero-stack tab and cutout 42

**MPAI electric cylinders** 18**MPAR electric cylinders** 18**MPAS linear stages** 18**MSF instruction** 228**multiple skip speed** 208**N****navigation buttons** 100**network**

- status indicator 143

**network parameters** 105**new tag**

- data type 113

**noise**

- abnormal 145
- feedback 144
- reduction 38

**O****open-loop frequency control** 198**P****panel requirements** 25**parameter list category** 126**passive shunt**

- use cases 30

**PFH definition** 164**pinouts**

- 24V input power connector 53
- AC input power connector 53
- auxiliary feedback 54
- DC bus connector 53
- digital inputs 54
- Ethernet connector 53
- feedback connector 55
- motor brake connector 55
- motor power connector 54
- safe torque-off 164
- safe torque-off (STO) 52
- shunt connector 53
- shunt resistor 53

**plan your installation** 25**power dissipation** 32**power tab**

- bus regulator 114
- power structure 114

**power up** 137**product selection website** 11**publications, related** 10**R****ramp attributes** 229**rated slip speed** 215

- related publications** 10
- remove/replace drive**
  - remove drive 157
  - remove power 156
  - replace drive 157
  - startup and configure 158
- requirements**
  - UL, CE, and UK 25
- routing power and signal wiring** 68
- RSLinx**
  - communication path 191

## S

- SAB** 81
- safe torque-off** 22, 165
  - bypass wiring 166
  - cascaded wiring 167
  - configurations
    - hardwired 22
  - operation 160
  - PFH 164
  - pinouts 52, 164
  - specifications 65, 168
- scaling category** 124, 130
- select**
  - AC line filter 26
  - enclosure 31
- sensorless vector** 119, 201
- servo motor compatibility** 80
- shared-bus**
  - connection system 43
    - catalog numbers 23
- shield clamp** 87, 92
- shunt connector**
  - pinouts 53
  - wiring 96
- shunt resistor**
  - interconnect diagram 172
  - passive 30
  - pinouts 53
- shutdown** 146
- sine/cosine** 136
  - with Hall 137
- skip speed** 207
- SLAT** 221
  - attributes 223
  - configuring 223
- slip test messaging** 217
- software**
  - Logix Designer application 107
- specifications**
  - auxiliary
    - feedback 59, 61
    - feedback encoders 62
  - brake relay 56
  - control power input 58
  - digital inputs 56
  - encoder phasing 63
  - EtherNet/IP connections 58
  - Kinetix 5300 drives 23
    - motor feedback 59
      - absolute position 64
      - generic TTL incremental 62
      - Hiperface 60

- Nikon 60
    - sin/cos incremental 61
    - Tamagawa 60
  - safe torque-off 65, 168
- speed limited adjustable torque** 221
- SPM motor closed-loop axis properties** 122
- stability control** 205
- startup sequence** 104, 137
- static motor test** 215
- status display** 100, 137
  - flowchart 102
  - menu 101
  - navigation buttons 100
  - startup sequence 104
- status indicators**
  - link speed status 143
  - link/activity status 143
  - module status 143
  - network status 143
- STO**
  - connector pinouts 164
  - connector wiring 165
- stop**
  - drive 146
  - planner 146
- stopping actions**
  - configure 146
- Studio 5000 Logix Designer** 106
- system**
  - block diagrams
    - power 184
  - components 14
    - ground 71
  - mounting requirements 25
  - overview
    - EtherNet/IP 19, 20, 21
    - standalone 15, 16, 17
- system overview**
  - safe torque off 22

## T

- testing axes**
  - hookup test 139
- time synchronization** 109
- torque proving** 231
  - attributes 231
  - configuring 233
- training** 9
- transformer sizing** 27
- troubleshooting**
  - alarm 145, 146
  - ControlFLASH 195
  - controller/drive fault behavior 145
  - disable 146
  - fault
    - code summary 142
    - codes 142
    - status only 146
  - general system problems 144
    - abnormal noise 145
    - axis unstable 144
    - erratic operation 145
    - feedback noise 144
    - motor accel/decel 144
    - motor overheating 145

- motor velocity 144
- no rotation 144
- ignore 145, 146
- link speed status indicator 143
- link/activity status indicator 143
- major fault 145
- minor fault 145
- module
  - status indicator 143
- network status indicator 143
- safety precautions 141
- shutdown 146
- status indicators 143
- stop
  - drive 146
  - planner 146
- stopping actions 146
  - definitions 146
- typical installation**
  - EtherNet/IP 19, 20, 21
  - standalone 15, 16, 17

## U

- UK**
  - compliance 24
- UL, CE, and UK requirements** 25
- use cases**
  - passive shunt 30

## V

- valid feedback types** 134
  - digital AqB TTL 134
  - digital AqB with UVW 135
  - sine/cosine 136
  - sine/cosine with Hall 137
- velocity droop** 234
  - attribute 235
  - configure 235
- verify update** 195
- vertical load** 116
- virtual torque sensor** 238
- voltage drop**
  - 24V input power 29

## W

- web server interface** 150
  - categories 150
  - web pages 150
- website**
  - certifications 11, 159
  - product selection 11

## wiring

- 24V connector 76
- auxiliary feedback 78
- build your own cables 68
- capacitor module 96
- converter kit shield clamp 92
- digital inputs 78
- earth ground 71
- Ethernet cables 97
- external shunt resistor 96
- grounded power configuration 69
- guidelines 75
- input power 77
- input power type 69
- motor brake 79
- motor cable shield clamp 87
- motor power 79, 86
- RC connector 96
- requirements 67, 73
- routing power and signal wiring 68
- safe torque-off bypass 166
- safe torque-off cascaded 167
- STO connector 165

## Z

- zero-stack tab and cutout** 42



# Rockwell Automation Support

Use these resources to access support information.

<b>Technical Support Center</b>	Find help with how-to videos, FAQs, chat, user forums, Knowledgebase, and product notification updates.	<a href="http://rok.auto/support">rok.auto/support</a>
<b>Local Technical Support Phone Numbers</b>	Locate the telephone number for your country.	<a href="http://rok.auto/phonesupport">rok.auto/phonesupport</a>
<b>Technical Documentation Center</b>	Quickly access and download technical specifications, installation instructions, and user manuals.	<a href="http://rok.auto/techdocs">rok.auto/techdocs</a>
<b>Literature Library</b>	Find installation instructions, manuals, brochures, and technical data publications.	<a href="http://rok.auto/literature">rok.auto/literature</a>
<b>Product Compatibility and Download Center (PCDC)</b>	Download firmware, associated files (such as AOP, EDS, and DTM), and access product release notes.	<a href="http://rok.auto/pcdc">rok.auto/pcdc</a>

## Documentation Feedback

Your comments help us serve your documentation needs better. If you have any suggestions on how to improve our content, complete the form at [rok.auto/docfeedback](http://rok.auto/docfeedback).

## Waste Electrical and Electronic Equipment (WEEE)



At the end of life, this equipment should be collected separately from any unsorted municipal waste.





Rockwell Automation maintains current product environmental compliance information on its website at [rok.auto/pec](http://rok.auto/pec).

Allen-Bradley, CompactLogix, ControlFLASH, ControlFLASH Plus, ControlLogix, expanding human possibility, FactoryTalk, GuardLogix, Kinetix, Logix 5000, PanelView, POINT I/O, Rockwell Automation, RSLinx, Stratix, Studio 5000, and Studio 5000 Logix Designer are trademarks of Rockwell Automation, Inc.

CIP Safety, CIP Security, CIP Sync, and EtherNet/IP are trademarks of ODVA, Inc.

Trademarks not belonging to Rockwell Automation are property of their respective companies.

Rockwell Otomasyon Ticaret A.Ş. Kar Plaza İş Merkezi E Blok Kat:6 34752, İçerenköy, İstanbul, Tel: +90 (216) 5698400 EEE Yönetmeliğine Uygundur

Connect with us.    

**rockwellautomation.com** ————— expanding **human possibility**<sup>®</sup>

AMERICAS: Rockwell Automation, 1201 South Second Street, Milwaukee, WI 53204-2496 USA, Tel: (1) 414.382.2000, Fax: (1) 414.382.4444

EUROPE/MIDDLE EAST/AFRICA: Rockwell Automation NV, Pegasus Park, De Kleetlaan 12a, 1831 Diegem, Belgium, Tel: (32) 2 663 0600, Fax: (32) 2 663 0640

ASIA PACIFIC: Rockwell Automation, Level 14, Core F, Cyberport 3, 100 Cyberport Road, Hong Kong, Tel: (852) 2887 4788, Fax: (852) 2508 1846

UNITED KINGDOM: Rockwell Automation Ltd. Pitfield, Kiln Farm Milton Keynes, MK11 3DR, United Kingdom, Tel: (44)(1908) 838-800, Fax: (44)(1908) 261-917

Publication 2198-UM005D-EN-P - December 2022

Supersedes Publication 2198-UM005C-EN-P - February 2022

Copyright © 2022 Rockwell Automation, Inc. All rights reserved. Printed in the U.S.A.