

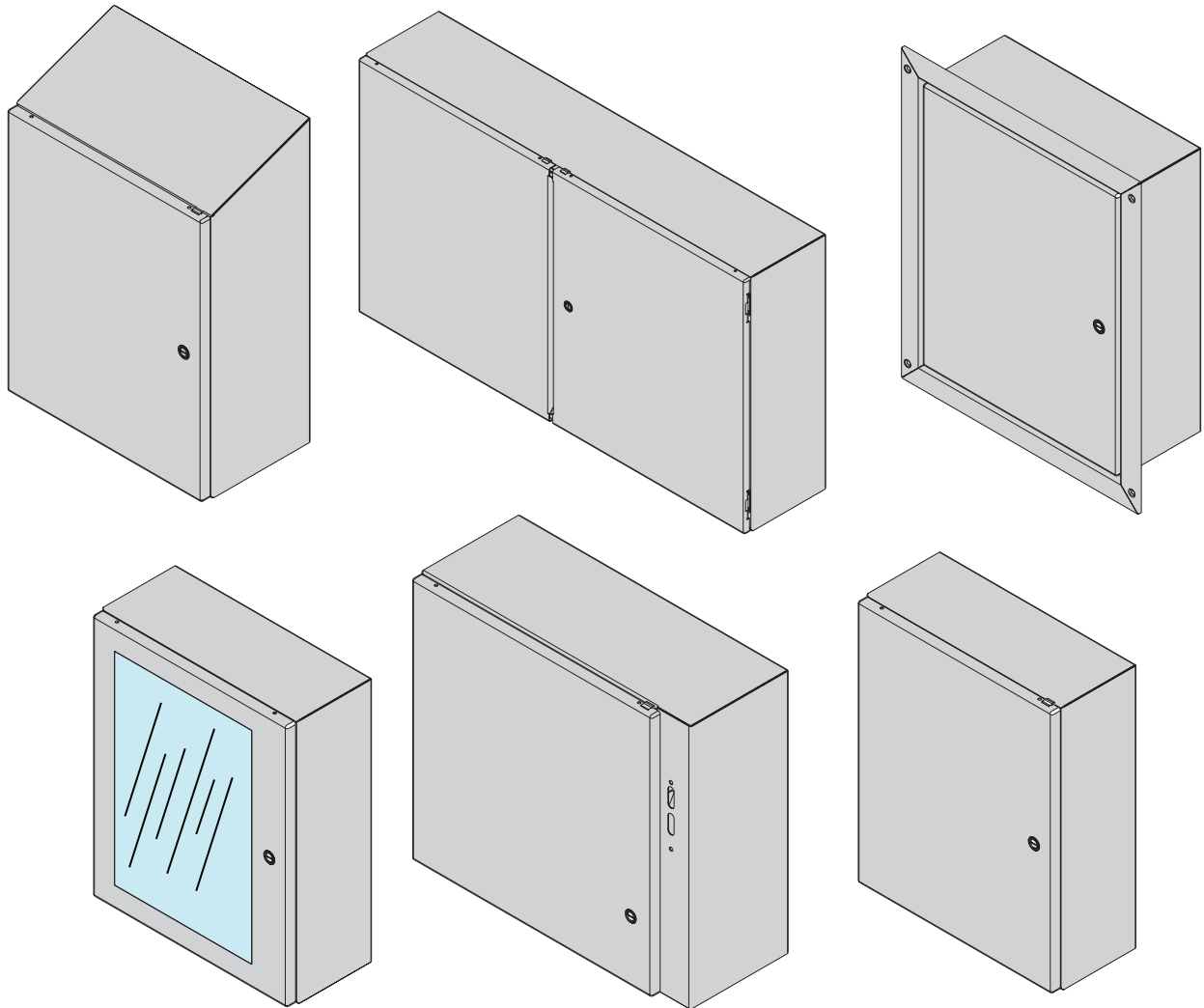

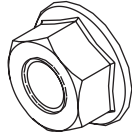



# CONCEPT

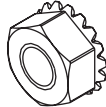
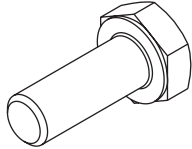

1	M8X1.25	2	3/8	3	M6X1
					
(4x) (8x)		(1x)		(6x)	
4	M6X1	5	3/8	6	3/8
					
(2x)		(4x)		(4x)	
7		8	1/2	9	
					
(2x)		(4x)		(0x)	

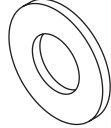
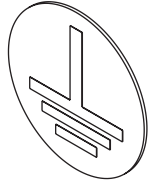
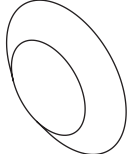