

Cable Ladder

rung spacing 300 mm, with continuously perforated side profiles, with riveted, upwardly open rungs made of C-profiles with 11 mm slot width

KL 60.603 E3

EAN Code: 4013339341108

Smallest packaging unit: 6 m

quantity unit: m M

the photorealistic images are to be considered as reference images

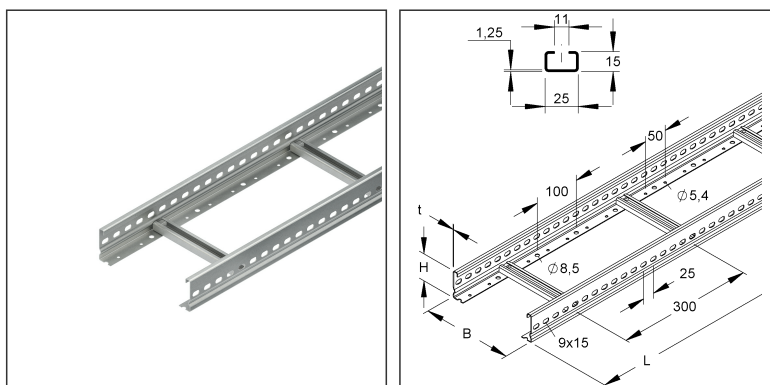
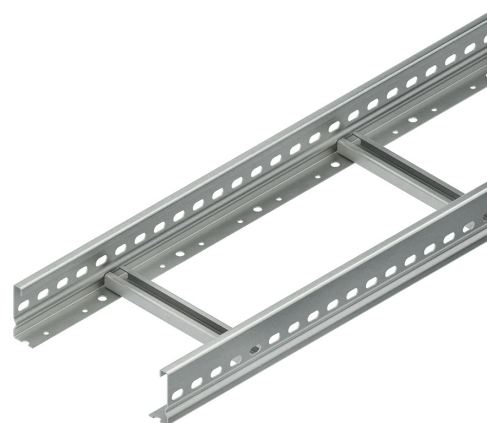

Article Description

Cable ladder, 60x600x6000 mm, t=1,5 mm, perforated, stainless steel, material code: 1.4301, AISI 304

Additional Price Information

Article group	N13
quantity unit	m

Weight

Weight per quantity unit	3,378 kg / m
Weight in kg per 100	338 kg / 100m

Technical Datasheet

Cable Ladder System

KL 60.603 E3

the photorealistic images are to be considered as reference images

Physical Article Dimensions

Height	60.00 mm
Width	600 mm
Depth/length	6000 mm

Load Specifications

Load diagram: q = evenly distributed cable load (tested acc. to DIN EN IEC 61537)

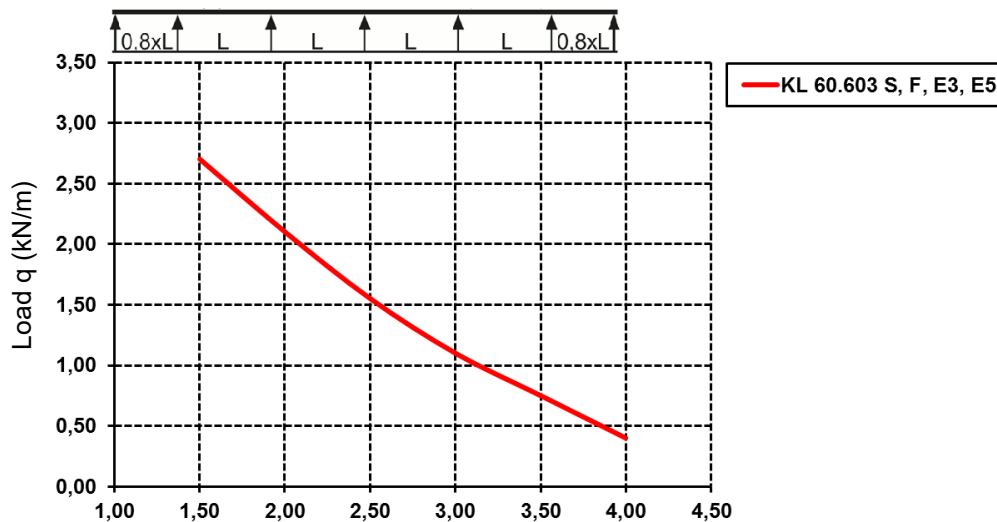

Fixing distance (m)

The load details shown in the diagram are independent of the position of the connectors.

Packing Dimension

6 meters = 1 piece		✓ VP1-smallest packaging unit (PU)	✓ VP1-preferred PU		
Lenght	6000 mm	Width	600 mm	Height	60.00 mm
Gross weight	20 kg	Volume	0,216 m ³		
Min. quantity	6.00 m	Max. Quantity	6.00 m		

Tender Text

Cable ladder acc. to DIN EN 61537, with continuously perforated and profiled side beams, with riveted rungs made of C-profiles with 11 mm slot width.

Suitable U-clamps (BA...).

Dimensions (approx. dimensions)

Height H x width W : 60 x 600 mm

Material thickness beam : 1.5 mm

Distance between rungs : 300 mm

Side beam perforation : 9 x 15 mm

Centre distance : 25 mm

Bottom perforation : Ø 8.5 and Ø 5.4 mm

Centre distance : 100 mm and 50 mm

Delivery length L : 6000 mm

Transport length : 6000 mm + W

Usable cross-section : 25900 mm²

Material : stainless steel, material no. 1.4301, AISI 304

NIEDAX Model No. : KL 60.603 E3

Technical Datasheet

Cable Ladder System

KL 60.603 E3

the photorealistic images are to be considered as reference images

Tender Text

EP Material _____ EP Wage _____
Unit price/meter

Safety & Environment

REACH Date	25.06.2025
REACH Info	Conformable
RoHS Info	Conformable

Origin & International Trade

Country of origin	DE
Federal State of Origin	RP
Customs tariff number	73089059

Related items

Cover

Model No.	Description
RD 600 E3	Cover for cable tray/-ladder, with joint strip, 602x3000 mm, stainless steel, material code: 1.4301, AISI 304
RDRS 9 E3	Turning bolt with locking nut acc. to DIN EN ISO 10511, stainless steel, material code: 1.4301, AISI 304, incl. accessories
RDV 600 E3	Cover for cable tray/-ladder, with joint strip, 602x3000 mm, stainless steel, material code: 1.4301, AISI 304

Barrier strip

Model No.	Description
KLWC 11 E3	Barrier strip fastening clamp, for 11 mm slot width, stainless steel, material code: 1.4301, AISI 304, incl. accessories
RW 35 E3	Barrier strip, 30x3000 mm, t=0,8 mm, stainless steel, material code: 1.4301, AISI 304, incl. accessories

Connector

Model No.	Description
KSV 60 E3	Splice plate for cable ladder, height 60 mm, stainless steel, mat. code: 1.4301, AISI 304, washed, incl. accessories