

C-Profile Type 2970

C-profile, slot width 16 mm, acc. to DIN EN 60715, perforated

2970/2 GL

EAN Code: 4013339030101

Smallest packaging unit: 10 x 2 m

quantity unit: m M

the photorealistic images are to be considered as reference images

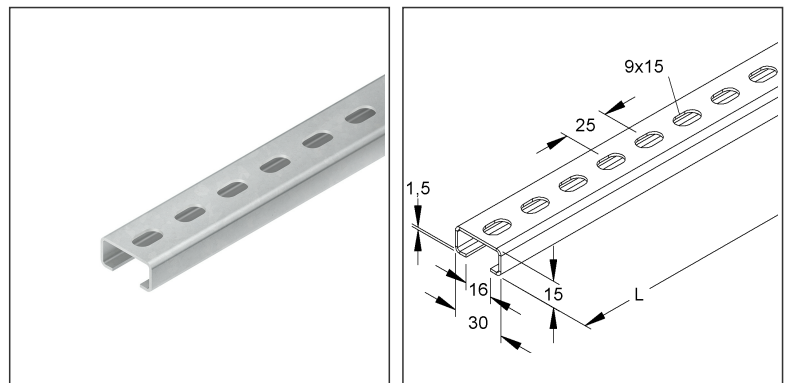

Article Description

C-profile, C-profile, slot width 16 mm, 30x15x2000 mm, perforated, steel, galvanised acc. to DIN EN ISO 19598, thick-film passivated

Weight

Weight per quantity unit	700 g / m
Weight in kg per 100	70 kg / 100m

Physical Article Dimensions

Height	15.00 mm
Width	30.00 mm
Depth/length	2000 mm

Technical Datasheet

Niedax rails

2970/2 GL

the photorealistic images are to be considered as reference images

Additional Price Information

Article group	N05
quantity unit	m

Packing Dimension

20 meters = 1 bundle		✓ VP1-smallest packaging unit (PU)		✓ VP1-preferred PU	
Lenght	2000 mm	Width	85.00 mm	Height	50.00 mm
Gross weight	14 kg	Volume	0,008 m ³		
Min. quantity	20.00 m	Max. Quantity	20.00 m		
1200 meters = 1 rack					
Lenght	2000 mm	Width	850 mm	Height	770 mm
Gross weight	898 kg	Volume	1,309 m ³		
Min. Quantity	1.200.00 m	Max. Quantity	1.200.00 m		

Tender Text

C-profile model 2970 acc. to DIN EN 60715, perforated.
Suitable U-clamps (B... and BK...).

The SKC 70 protective cap must be fitted in personal danger areas. To ensure that the protective cap can be fitted easily, a distance of at least 30 mm from the end of the profile must be left.

Dimensions (approx. dimensions)
Height H x width W x material thickness t : 15 x 30 x 1.5 mm
Slot width : 16 mm
Profile perforation : 9 x 15 mm
central distance : 25 mm
Delivery length L : 2000 mm

Material : steel, electro galvanised acc. to DIN EN ISO 19598, thick-film passivated

NIEDAX model no. : 2970/2 GL
EP material_____ EP wage_____

Unit price/meter

Safety & Environment

REACH Date	25.06.2025
REACH Info	Conformable
RoHS Info	Conformable

Origin & International Trade

Country of origin	DE
Customs tariff number	73269098