

Cable U-clamp

with pressure trough

B 26/2 E3

EAN Code: 4013339083701

Smallest packaging unit: 100 pcs.

the photorealistic images are to be considered as reference images

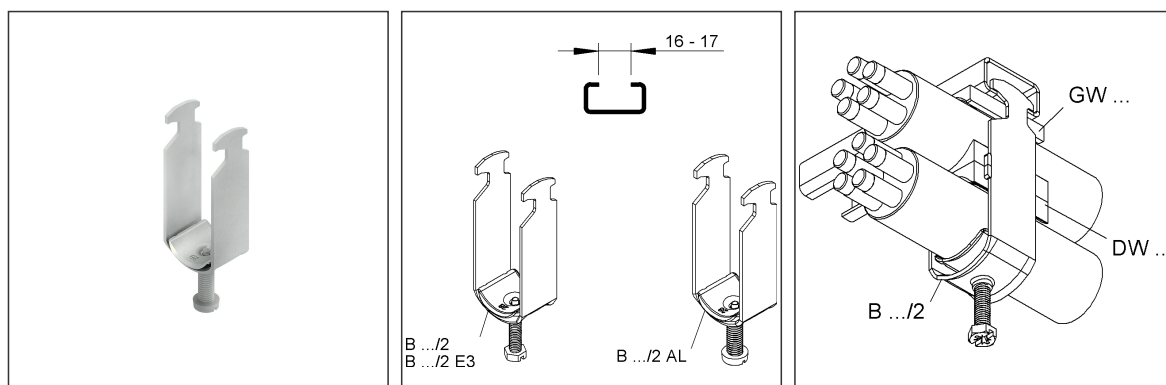

Article Description

Cable U-clamp, for 2 cables, Ø 22-26 mm, slot width 16-17 mm, stain.steel,mat.: 1.4301, AISI 304, w. stainless steel pressure trough

Additional Price Information

Article group	N08
quantity unit	pcs.

Weight

Weight per quantity unit	57 g / pcs.
Weight in kg per 100	5,69 kg / 100pcs.

Technical Datasheet

U-clamps

B 26/2 E3

the photorealistic images are to be considered as reference images

Physical Article Dimensions

Height	30.00 mm
Width	105.00 mm
Depth/length	29.00 mm

Packing Dimension

100 pieces = 1 carton		✓ VP1-smallest packaging unit (PU)		✓ VP1-preferred PU	
Lenght	420 mm	Width	250 mm	Height	120.00 mm
Volume	0,013 m ³	Gross weight	6,24 kg		
Min. quantity	100.00 pcs.	Max. Quantity	100.00 pcs.		
4900 pieces = 1 pallet					
Lenght	1200 mm	Width	800 mm	Height	1000 mm
Gross weight	321 kg	Volume	0,960 m ³		
Min. Quantity	4.900.00 pcs.	Max. Quantity	4.900.00 pcs.		

Tender Text

Hammerfoot clamp, with pressure trough and M 6 pivot bolt with multiple drive.
Counter trays GW ... and double tray DW... please order separately.
For use in functional maintenance, please observe additional regulations!
Used for: C-profile rails with 16 - 17 mm slot width
Dimensions (approx. dimensions)
Assignment one above the other: 2 cables
for cable Ø : 24 - 26 mm
Material hammerfoot stirrup : stainless steel, material no. 1.4301, AISI 304
Material pressure trough : stainless steel, material no. 1.4301, AISI 304
NIEDAX model no. : B 26/2 E3
EP Material_____ EP Wage_____
Unit price/piece

Safety & Environment

REACH Date	25.06.2025
REACH Info	Conformable
RoHS Info	Conformable

Origin & International Trade

Country of origin	DE
Customs tariff number	73269098