

Cable U-clamp

with pressure trough

B 34/2 AL

EAN Code: 4013339070909
Smallest packaging unit: 100 pcs.

the photorealistic images are to be considered as reference images

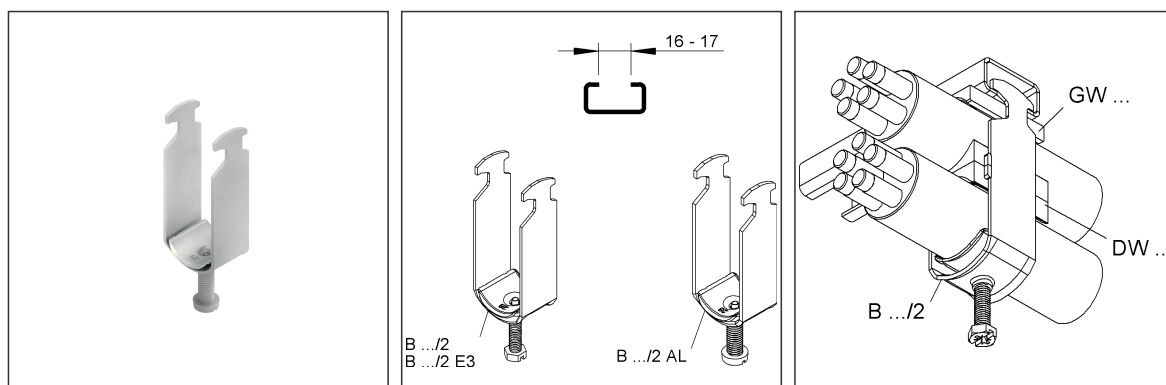

Article Description

Cable U-clamp, for 2 cables, Ø 30-34 mm, slot width 16-17 mm, aluminium, with aluminium pressure trough

Additional Price Information

Article group	N08
quantity unit	pcs.

Weight

Weight per quantity unit	36 g / pcs.
Weight in kg per 100	3,53 kg / 100pcs.

Physical Article Dimensions

Height	39.00 mm
Width	129.00 mm
Depth/length	42.00 mm

Technical Datasheet

U-clamps

B 34/2 AL

the photorealistic images are to be considered as reference images

Packing Dimension

100 pieces = 1 carton		✓ VP1-smallest packaging unit (PU)		✓ VP1-preferred PU	
Lenght	480 mm	Width	280 mm	Height	140.00 mm
Volume	0,019 m ³	Gross weight	4,42 kg		
Min. quantity	100.00 pcs.	Max. Quantity	100.00 pcs.		

3600 pieces = 1 pallet					
Lenght	1200 mm	Width	800 mm	Height	1000 mm
Gross weight	174 kg	Volume	0,960 m ³		
Min. Quantity	3.600.00 pcs.	Max. Quantity	3.600.00 pcs.		

Tender Text

Hammerfoot clamp, with pressure trough and M 8 pivot bolt to DIN EN ISO 1207 with multiple drive.
Counter tray GW ... and double tray DW... please order separately.
Used for: C-profile rails with 16 - 17 mm slot width
Dimensions (approx.)
Assignment one above the other: 2 cables
for cable Ø : 30 - 34 mm
Material Hammerfoot stirrup : aluminum
Material of pressure trough : aluminum
NIEDAX model no. : B 34/2 AL
EP Material _____ EP Wage _____
Unit price/piece

Safety & Environment

REACH Date	25.06.2025
REACH Info	Conformable
RoHS Info	Conformable

Origin & International Trade

Country of origin	DE
Customs tariff number	76169990