

### Cable U-clamp

with pressure trough

**B 38/2 E3**

EAN Code: 4013339084005  
Smallest packaging unit: 50 pcs.

the photorealistic images are to be considered as reference images

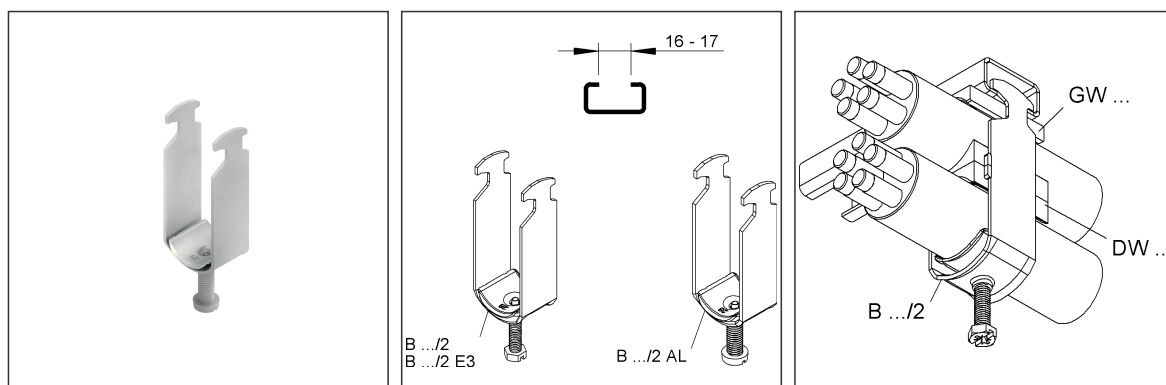

### Article Description

Cable U-clamp, for 2 cables, Ø 34-38 mm, slot width 16-17 mm, stain.steel,mat.: 1.4301, AISI 304, w. stainless steel pressure trough

### Additional Price Information

Article group	N08
quantity unit	pcs.

### Weight

Weight per quantity unit	91 g / pcs.
Weight in kg per 100	9,06 kg / 100pcs.

# Technical Datasheet

## U-clamps

B 38/2 E3

the photorealistic images are to be considered as reference images

### Physical Article Dimensions

Height	42.00 mm
Width	141.00 mm
Depth/length	42.00 mm

### Packing Dimension

<b>50 pieces = 1 carton</b>		✓ VP1-smallest packaging unit ( PU)		✓ VP1-preferred PU	
Lenght	420 mm	Width	250 mm	Height	120.00 mm
Volume	0,013 m <sup>3</sup>	Gross weight	5,08 kg		
Min. quantity	50.00 pcs.	Max. Quantity	50.00 pcs.		

<b>2450 pieces = 1 pallet</b>					
Lenght	1200 mm	Width	800 mm	Height	1000 mm
Gross weight	264 kg	Volume	0,960 m <sup>3</sup>		
Min. Quantity	2.450.00 pcs.	Max. Quantity	2.450.00 pcs.		

### Tender Text

Hammerfoot clamp, with pressure trough and M 6 pivot bolt with multiple drive.  
Counter trays GW ... and double tray DW... please order separately.  
For use in functional maintenance, please observe additional regulations!  
Used for: C-profile rails with 16 - 17 mm slot width  
Dimensions (approx. dimensions)  
Assignment one above the other: 2 cables  
for cable Ø : 36 - 38 mm  
Material Hammerfoot stirrup : stainless steel, material no. 1.4301, AISI 304  
Material pressure trough : stainless steel, material no. 1.4301, AISI 304  
NIEDAX model no. : B 38/2 E3  
EP Material\_\_\_\_\_ EP Wage\_\_\_\_\_  
Unit price/piece

### Safety & Environment

REACH Date	25.06.2025
REACH Info	Conformable
RoHS Info	Conformable

### Origin & International Trade

Country of origin	DE
Customs tariff number	73269098