

Hammer Head Bolt M8

incl. nut and washer

HM 408/30

EAN Code: 4013339122905
Smallest packaging unit: 50 pcs.

the photorealistic images are to be considered as reference images

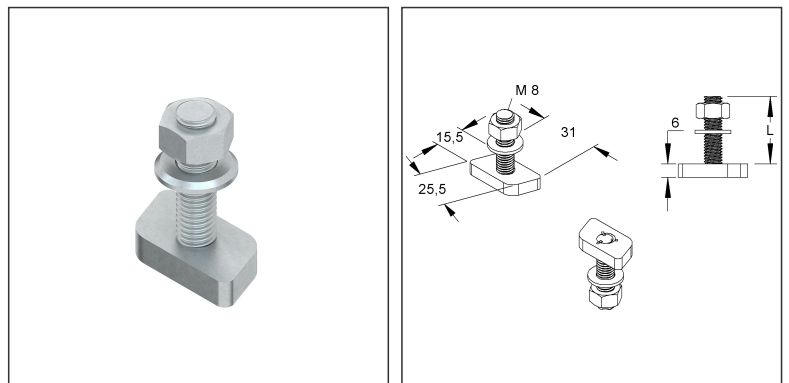
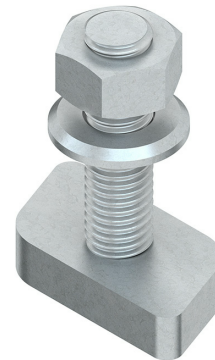

Article Description

Hammer head bolt M8, with nut and washer, length 30 mm, steel, electro galvanized according to DIN EN ISO 2081/4042, blue pass

Additional Price Information

Article group	N09
quantity unit	pcs.

Weight

Weight per quantity unit	36 g / pcs.
Weight in kg per 100	3,6 kg / 100pcs.

Technical Datasheet

Screws and nuts

HM 408/30

the photorealistic images are to be considered as reference images

Physical Article Dimensions

Height	36.00 mm
Width	31.10 mm
Depth/length	15.50 mm

Packing Dimension

50 pieces = 1		✓ VP1-smallest packaging unit (PU)		✓ VP1-preferred PU	
Lenght	138.00 mm	Width	96.00 mm	Height	71.00 mm
Gross weight	1,86 kg	Volume	0,001 m ³		
Min. quantity	50.00 pcs.	Max. Quantity	50.00 pcs.		
6900 pieces = 1					
Lenght	750 mm	Width	750 mm	Height	730 mm
Gross weight	297 kg	Volume	0,411 m ³		
Min. Quantity	6.900.00 pcs.	Max. Quantity	6.900.00 pcs.		

Tender Text

Hammerhead bolt with hexagon nut and washer, can be used at any point in the profile.
Use for : anchor channels 2970, 2971, 2972, 2975 and 2980 with 16 mm slot width
Dimensions (approx. dimensions)
Head length : 31 mm
Head width : 15.5 mm
Head height : 6 mm
Thread : M 8
Length L : 30 mm
Strength class : 4.6
Material : Steel, galvanised acc. to DIN EN ISO 4042, blue passivated
NIEDAX Model-No. : HM 408/30
EP Material _____ EP Lohn _____
Unit price/piece

Safety & Environment

REACH Date	25.06.2025
REACH Info	Conformable
RoHS Info	Conformable

Origin & International Trade

Country of origin	DE
Customs tariff number	73181595