

Wide Span Cable Tray

perforated, with continuous perforated and beaded side profiles

WRL 105.600 F

EAN Code: 4013339588206

Smallest packaging unit: 6 m

quantity unit: m M



the photorealistic images are to be considered as reference images

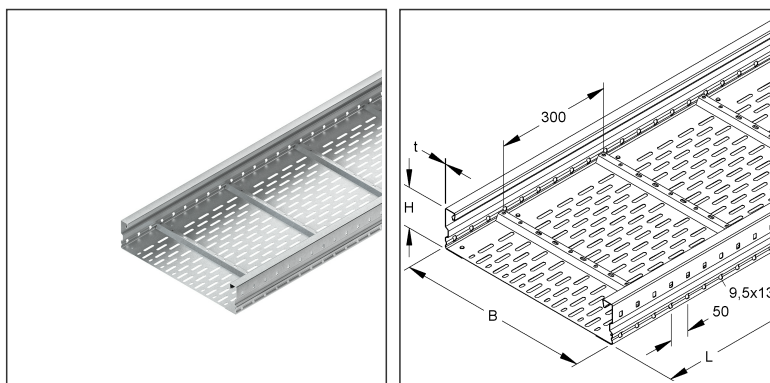

Article Description

Wide span cable tray, 105x600x6000 mm, t=1,5 mm, perforated, steel, hot dip galvanised DIN EN ISO 1461, incl. accessories

Technical Datasheet

Long Span Cable Tray

WRL 105.600 F

the photorealistic images are to be considered as reference images

Incl. accessories

6 meter = 1 piece		✓ lowest delivery unit	✓ preferred delivery unit
Model No.	Description	quantity	
FLM 6X12 F	Mushroom-head bolt M6, similar DIN 603, length 12 mm, steel, hot dip galvanised DIN EN ISO 1461	4 pcs.	
RSL 600 F	Joint bar for wide span cable tray, B=589 mm, for bottom stabilisation, steel, hot dip galvanised DIN EN ISO 1461, incl. accessories	1 pcs.	
84 meter = 1 bundle		- lowest delivery unit	- preferred delivery unit
Model No.	Description	quantity	
FLM 6X12 F	Mushroom-head bolt M6, similar DIN 603, length 12 mm, steel, hot dip galvanised DIN EN ISO 1461	56 pcs.	
RSL 600 F	Joint bar for wide span cable tray, B=589 mm, for bottom stabilisation, steel, hot dip galvanised DIN EN ISO 1461, incl. accessories	14 pcs.	

Additional Price Information

Article group	N13
quantity unit	m

Weight

Weight per quantity unit	9,771 kg / m
Weight in kg per 100	977 kg / 100m

Physical Article Dimensions

Height	105.00 mm
Width	600 mm
Depth/length	6000 mm

Load Specifications

Load diagram: q = evenly distributed cable load (tested acc. to DIN EN IEC 61537)

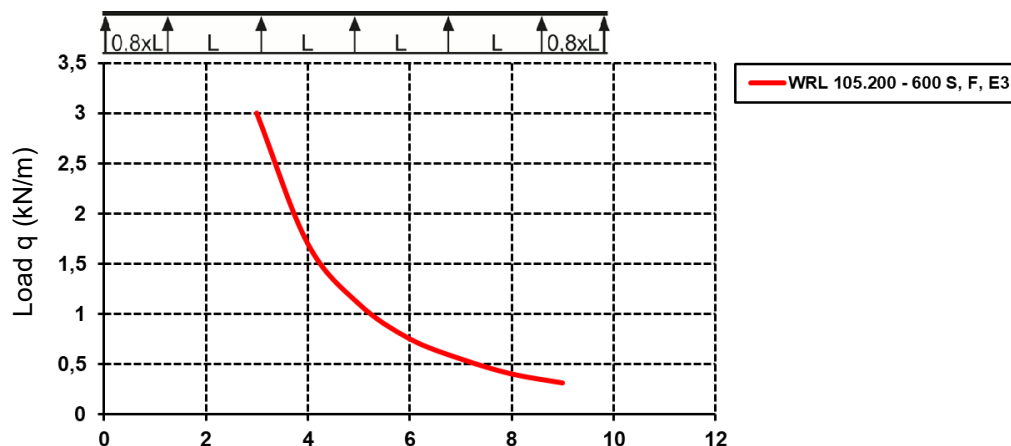

Fixing distance (m)

The load details shown in the diagram are independent of the position of the connectors.

Technical Datasheet

Long Span Cable Tray

WRL 105.600 F

the photorealistic images are to be considered as reference images

Packing Dimension

6 meters = 1 piece		✓ VP1-smallest packaging unit (PU)		✓ VP1-preferred PU	
Lenght	6000 mm	Width	600 mm	Height	105.00 mm
Gross weight	59 kg	Volume	0,378 m ³		
Min. quantity	6.00 m	Max. Quantity	6.00 m		
84 meters = 1 bundle					
Lenght	6000 mm	Width	630 mm	Height	860 mm
Gross weight	821 kg	Volume	3,251 m ³		
Min. Quantity	84.00 m	Max. Quantity	84.00 m		

Tender Text

<p>Wide span cable tray, acc. to DIN EN 61537, with continuous perforated and beaded side rails as well as riveted bottom with offset perforation and perforated cross beads for stabilisation and barrier strip fastening, including a joint bar RSL..., proportional fastening accessories in hot-dip galvanised.</p> <p>Please order splice plate WSV 105.390 separately.</p> <p>Dimensions (approx. dimensions)</p> <p>Height H x width W : 105 x 600 mm</p> <p>Material thickness : 1.5 mm</p> <p>Cross section distance : 300 mm</p> <p>Side rail perforation : 9.5 x 13 mm</p> <p>Hole distance : 50 mm</p> <p>Delivery length : 6000 mm</p> <p>Usable cross-section : 50995 mm²</p> <p>Material : steel, hot-dip galvanised acc. to DIN EN ISO 1461</p> <p>NIEDAX Model No. : WRL 105.600 F</p> <p>EP Material_____ EP wage_____</p> <p>Unit price/meter</p>

Safety & Environment

REACH Date	25.06.2025
REACH Info	Conformable
RoHS Info	Conformable

Origin & International Trade

Country of origin	DE
Customs tariff number	73089059

Technical Datasheet

Long Span Cable Tray

WRL 105.600 F

the photorealistic images are to be considered as reference images

Related items

Cover

Model No.	Description
WDRS 20 F	Turning bolt with locknut acc. to DIN EN ISO 10511, for WSL/WRL, steel, hot dip galvanised DIN EN ISO 1461, incl. accessories
WDV 600 F	Cover for WSL/WRL, w. joint strip, 604x3000 mm, with turning lock, steel, hot dip galvanised DIN EN ISO 1461

Barrier strip

Model No.	Description
KLWC 16 F	Barrier strip fastening clamp, for 16 mm slot width, steel, hot dip galvanised DIN EN ISO 1461, incl. accessories
RW 85 F	Barrier strip, 80x3000 mm, t=0,9 mm, steel, hot dip galvanised DIN EN ISO 1461, incl. accessories

Connector

Model No.	Description
WSV 105.390 F	Splice plate, 106,5x390 mm, steel, hot dip galvanised DIN EN ISO 1461, incl. accessories