

Wide Span Cable Tray

perforated, with continuous perforated and beaded side profiles

WRL 150.500

EAN Code: 4013339313501

Smallest packaging unit: 6 m

quantity unit: m M

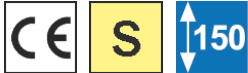

the photorealistic images are to be considered as reference images

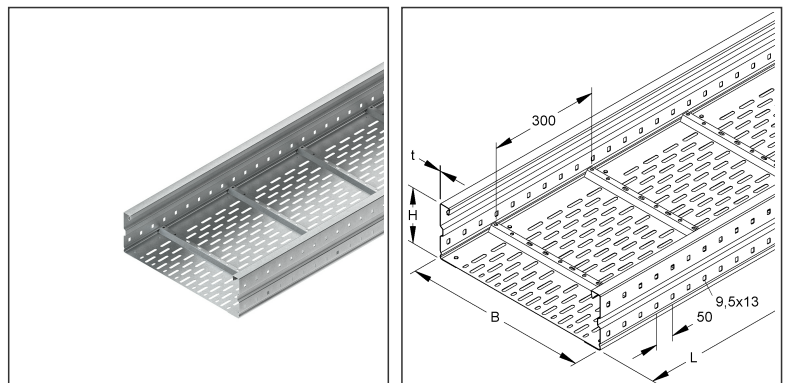

Article Description

Wide span cable tray, 150x500x6000 mm, t=1,5 mm, perforated, steel, pre-galvanised according to DIN EN 10346, incl. accessories

Technical Datasheet

Long Span Cable Tray

WRL 150.500

the photorealistic images are to be considered as reference images

Incl. accessories

6 meter = 1 piece		✓ lowest delivery unit	✓ preferred delivery unit
Model No.	Description	quantity	
FLM 6X12	Mushroom-head bolt M6, similar DIN 603, length 12 mm, steel, electro galvanised according to DIN EN ISO 2081/4042, blue pass	4 pcs.	
RSL 500	Joint bar for wide span cable tray, B=489 mm, for bottom stabilisation, steel, pre-galvanised according to DIN EN 10346, incl. accessories	1 pcs.	
60 meter = 1 bundle		- lowest delivery unit	- preferred delivery unit
Model No.	Description	quantity	
FLM 6X12	Mushroom-head bolt M6, similar DIN 603, length 12 mm, steel, electro galvanised according to DIN EN ISO 2081/4042, blue pass	40 pcs.	
RSL 500	Joint bar for wide span cable tray, B=489 mm, for bottom stabilisation, steel, pre-galvanised according to DIN EN 10346, incl. accessories	10 pcs.	

Additional Price Information

Article group	N13
quantity unit	m

Weight

Weight per quantity unit	9,183 kg / m
Weight in kg per 100	918 kg / 100m

Physical Article Dimensions

Height	150.00 mm
Width	500 mm
Depth/length	6000 mm

Load Specifications

Load diagram: q = evenly distributed cable load (tested acc. to DIN EN IEC 61537)

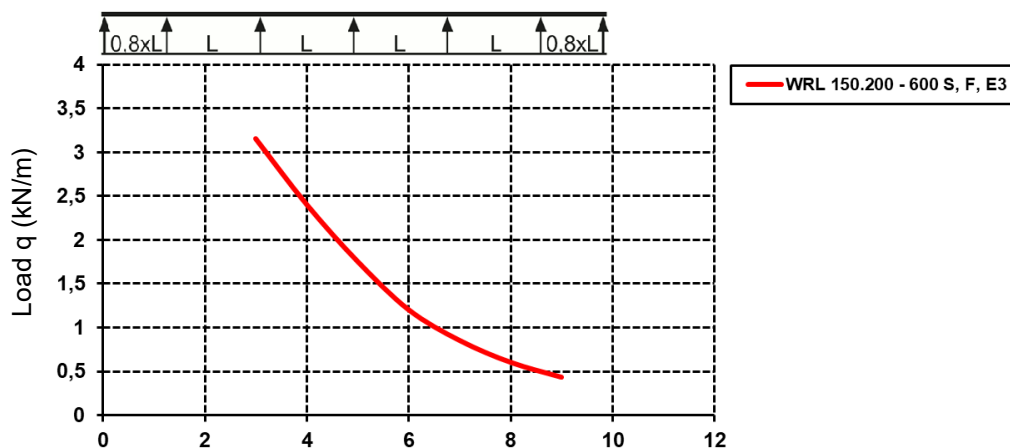

Fixing distance (m)

The load details shown in the diagram are independent of the position of the connectors.

Technical Datasheet

Long Span Cable Tray

WRL 150.500

the photorealistic images are to be considered as reference images

Packing Dimension

6 meters = 1 piece		✓ VP1-smallest packaging unit (PU)		✓ VP1-preferred PU	
Lenght	6000 mm	Width	500 mm	Height	150.00 mm
Gross weight	55 kg	Volume	0,450 m ³		
Min. quantity	6.00 m	Max. Quantity	6.00 m		

60 meters = 1 bundle					
Lenght	6000 mm	Width	530 mm	Height	860 mm
Gross weight	551 kg	Volume	2,735 m ³		
Min. Quantity	60.00 m	Max. Quantity	60.00 m		

Tender Text

Wide span cable tray, acc. to DIN EN 61537, with continuous perforated and beaded side rails as well as riveted bottom with offset perforation and perforated cross beads for stabilisation and barrier strip fastening, including a joint bar RSL..., proportional fastening accessories.
 Splice plate WSV 150.500 to be ordered separately.
 Dimensions (approx. dimensions)
 Height H x width W : 150 x 500 mm
 Material thickness : 1.5 mm
 Cross section distance : 300 mm
 Side rail perforation : 9.5 x 13 mm
 Hole distance : 50 mm
 Delivery length : 6000 mm
 Usable cross-section : 64735 mm²
 Material : steel, pre-galvanised acc. to DIN EN 10346
 NIEDAX Model No. : WRL 150.500
 EP material _____ EP wage _____
 Unit price/meter

Safety & Environment

REACH Date	25.06.2025
REACH Info	Conformable
RoHS Info	Conformable

Origin & International Trade

Country of origin	DE
Customs tariff number	73089059

Technical Datasheet

Long Span Cable Tray

WRL 150.500

the photorealistic images are to be considered as reference images

Related items

Cover

Model No.	Description
WDRS 20	Turning bolt with locknut acc. to DIN EN ISO 10511, for WSL/WRL, steel, pre-galvanised according to DIN EN 10346, incl. accessories
WDV 500	Cover for WSL/WRL, w. joint strip, 504x3000 mm, with turning lock, steel, pre-galvanised according to DIN EN 10346

Barrier strip

Model No.	Description
KLWC 16	Barrier strip fastening clamp, for 16 mm slot width, steel, pre-galvanised according to DIN EN 10346, incl. accessories
RW 110	Barrier strip, 98x3000 mm, t=0,9 mm, steel, pre-galvanised according to DIN EN 10346, incl. accessories

Connector

Model No.	Description
WSV 150.500	Splice plate, 151,5x500 mm, steel, pre-galvanised according to DIN EN 10346, incl. accessories

Accessories

Model No.	Description
WHAS 150 S	Wide span beam connection piece, height 150 mm, steel, pre-galvanised acc. to DIN EN 10346, incl. accessories