

Wide Span Cable Tray

unperforated, with unperforated and beaded side profiles, but with connector perforations

WRU 105.500 F

EAN Code: 4013339588602

Smallest packaging unit: 6 m

quantity unit: m M

the photorealistic images are to be considered as reference images

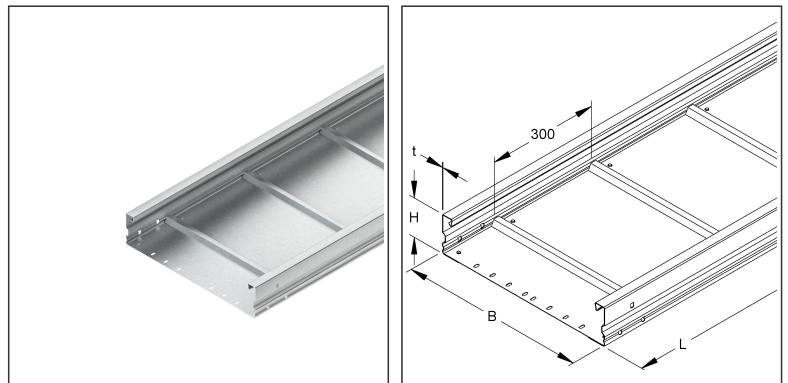

Article Description

Wide span cable tray, 105x500x6000 mm, t=1,5 mm, unperforated, steel, hot dip galvanised DIN EN ISO 1461, incl. accessories

Incl. accessories

6 meter = 1 piece

✓ lowest delivery unit

✓ preferred delivery unit

Model No.	Description	quantity
FLM 6X12 F	Mushroom-head bolt M6, similar DIN 603, length 12 mm, steel, hot dip galvanised DIN EN ISO 1461	4 pcs.
RSL 500 F	Joint bar for wide span cable tray, B=489 mm, for bottom stabilisation, steel, hot dip galvanised DIN EN ISO 1461, incl. accessories	1 pcs.

Additional Price Information

Article group	N13
quantity unit	m

Technical Datasheet

Long Span Cable Tray

WRU 105.500 F

the photorealistic images are to be considered as reference images

Weight

Weight per quantity unit	9,698 kg/ m
Weight in kg per 100	970 kg/ 100m

Physical Article Dimensions

Height	105.00 mm
Width	500 mm
Depth/length	6000 mm

Load Specifications

Load diagram: q = evenly distributed cable load (tested acc. to DIN EN IEC 61537)

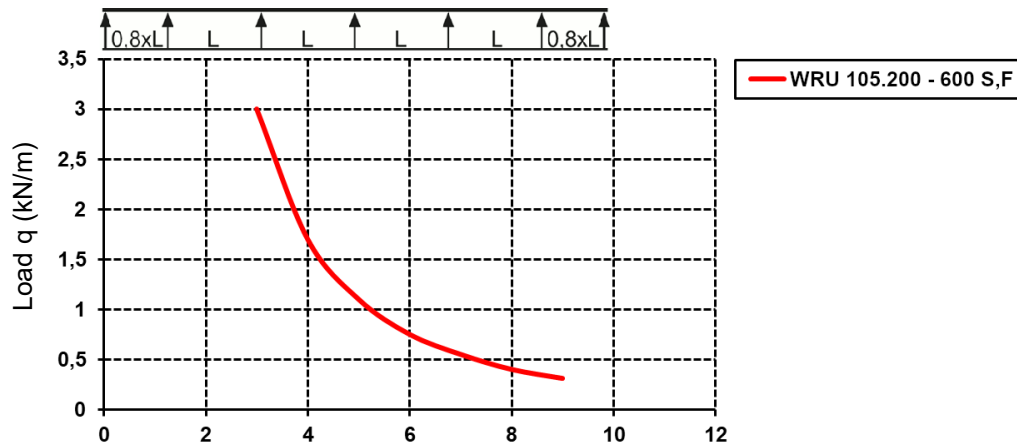

Fixing distance (m)

The load details shown in the diagram are independent of the position of the connectors.

Packing Dimension

6 meters = 1 piece		✓ VP1-smallest packaging unit (PU)	✓ VP1-preferred PU		
Lenght	6000 mm	Width	500 mm	Height	105.00 mm
Gross weight	58 kg	Volume	0,315 m ³		
Min. quantity	6.00 m	Max. Quantity	6.00 m		

Tender Text

Wide span cable tray, acc. to DIN EN 61537, with unperforated and beaded side rails, with connector perforation for connection, as well as riveted bottom with unperforated cross beads for stabilisation, including a joint bar RSL... and proportional fastening accessories in hot-dip galvanised. Please order WSV 105.390 splice plate separately.

Dimensions (approx. dimensions)

Height H x width W : 105 x 500 mm

Material thickness : 1.5 mm

Cross-section distance : 300 mm

Delivery length : 6000 mm

Usable cross-section : 42235 mm²

Material : steel, hot-dip galvanised acc. to DIN EN ISO 1461

NIEDAX Model No. : WRU 105.500 F

Technical Datasheet

Long Span Cable Tray

WRU 105.500 F

the photorealistic images are to be considered as reference images

Tender Text

EP Material _____ EP Wage _____
Unit price/meter

Safety & Environment

REACH Date	25.06.2025
REACH Info	Conformable
RoHS Info	Conformable

Origin & International Trade

Country of origin	DE
Customs tariff number	73089059

Related items

Cover

Model No.	Description
WDRS 20 F	Turning bolt with locknut acc. to DIN EN ISO 10511, for WSL/WRL, steel, hot dip galvanised DIN EN ISO 1461, incl. accessories
WDV 500 F	Cover for WSL/WRL, w. joint strip, 504x3000 mm, with turning lock, steel, hot dip galvanised DIN EN ISO 1461

Barrier strip

Model No.	Description
KLWC 16 F	Barrier strip fastening clamp, for 16 mm slot width, steel, hot dip galvanised DIN EN ISO 1461, incl. accessories
RW 85 F	Barrier strip, 80x3000 mm, t=0,9 mm, steel, hot dip galvanised DIN EN ISO 1461, incl. accessories

Connector

Model No.	Description
WSV 105.390 F	Splice plate, 106,5x390 mm, steel, hot dip galvanised DIN EN ISO 1461, incl. accessories