

Wide Span Cable Tray

unperforated, with unperforated and beaded side profiles, but with connector perforations

WRU 150.200

EAN Code: 4013339313709
 Smallest packaging unit: 6 m
 quantity unit: m M

the photorealistic images are to be considered as reference images

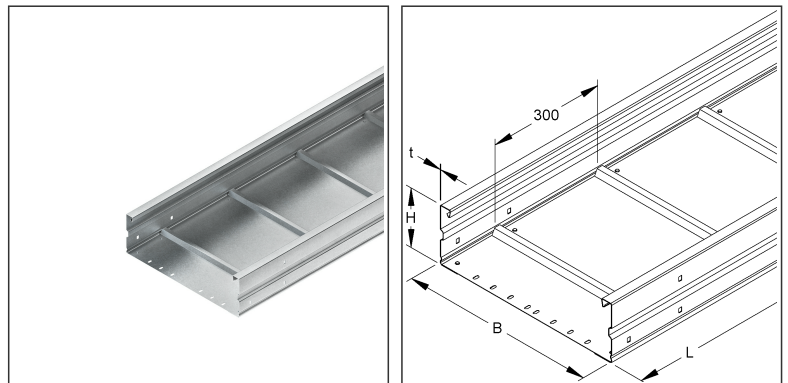

Article Description

Wide span cable tray, 150x200x6000 mm, t=1,5 mm, unperforated, steel, pre-galvanised according to DIN EN 10346

Additional Price Information

Article group	N13
quantity unit	m

Weight

Weight per quantity unit	7,560 kg / m
Weight in kg per 100	756 kg / 100m

Technical Datasheet

Long Span Cable Tray

WRU 150.200

the photorealistic images are to be considered as reference images

Physical Article Dimensions

Height	150.00 mm
Width	200.00 mm
Depth/length	6000 mm

Load Specifications

Load diagram: q = evenly distributed cable load (tested acc. to DIN EN IEC 61537)

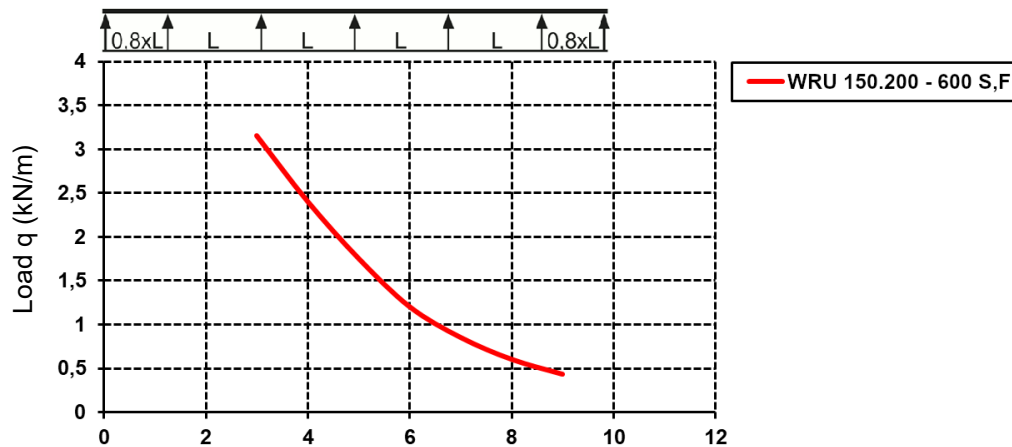

Fixing distance (m)

The load details shown in the diagram are independent of the position of the connectors.

Packing Dimension

6 meters = 1 piece		✓ VP1-smallest packaging unit (PU)	✓ VP1-preferred PU		
Lenght	6000 mm	Width	200.00 mm	Height	150.00 mm
Gross weight	45 kg	Volume	0,180 m ³		
Min. quantity	6.00 m	Max. Quantity	6.00 m		

Tender Text

Wide span cable tray, acc. to DIN EN 61537, with unperforated and beaded side rails, with connector perforation for connection, as well as riveted bottom with unperforated cross beads for stabilisation. Please order splice plate WSV 150.500 separately.

Dimensions (approx. dimensions)

Height H x width W : 150 x 200 mm

Material thickness : 1.5 mm

Cross-section distance : 300 mm

Delivery length : 6000 mm

Usable cross-section : 24955 mm²

Material : steel, pre-galvanised acc. to DIN EN 10346

NIEDAX Model No. : WRU 150.200

EP Material _____ EP Wage _____

Unit price/meter

Technical Datasheet

Long Span Cable Tray

WRU 150.200

the photorealistic images are to be considered as reference images

Safety & Environment

REACH Date	25.06.2025
REACH Info	Conformable
RoHS Info	Conformable

Origin & International Trade

Country of origin	DE
Customs tariff number	73089059

Related items

Cover

Model No.	Description
WDRS 20	Turning bolt with locknut acc. to DIN EN ISO 10511, for WSL/WRL, steel, pre-galvanised according to DIN EN 10346, incl. accessories
WDV 200	Cover for WSL/WRL, w. joint strip, 204x3000 mm, with turning lock, steel, pre-galvanised according to DIN EN 10346

Barrier strip

Model No.	Description
KLWC 16	Barrier strip fastening clamp, for 16 mm slot width, steel, pre-galvanised according to DIN EN 10346, incl. accessories
RW 110	Barrier strip, 98x3000 mm, t=0,9 mm, steel, pre-galvanised according to DIN EN 10346, incl. accessories

Connector

Model No.	Description
WSV 150.500	Splice plate, 151,5x500 mm, steel, pre-galvanised according to DIN EN 10346, incl. accessories