

Elbow 90°

with beaded, round and unperforated side profiles, but with connector perforations

WRBR 105.200 F

EAN Code: 4013339950218
Smallest packaging unit: 1 pc.

the photorealistic images are to be considered as reference images

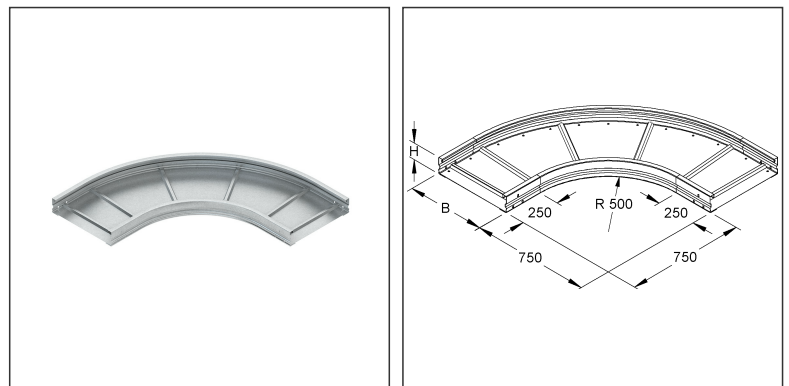

Article Description

Elbow 90° for WRL, 105x200 mm, round, beaded, unperforated, steel, hot dip galvanised DIN EN ISO 1461

Additional Price Information

Article group	N13
quantity unit	pcs.

Weight

Weight per quantity unit	11 kg / pcs.
Weight in kg per 100	1058 kg / 100pcs.

Physical Article Dimensions

Height	105.00 mm
Width	950 mm
Depth/length	950 mm

Technical Datasheet

Long Span Cable Tray

WRBR 105.200 F

the photorealistic images are to be considered as reference images

Packing Dimension

1 piece = 1 piece		✓ VP1-smallest packaging unit (PU)			
Lenght	950 mm	Width	950 mm	Height	105.00 mm
Gross weight	11 kg	Volume	0,095 m ³		
Min. quantity	1.00 pcs.	Max. Quantity	1.00 pcs.		

Tender Text

Elbow 90°, with beaded, round and unperforated side rails, with connector perforation for the connection, for wide span cable trays, dimensionally stable due to the beaded and unperforated bottom riveted over the entire surface, for creating horizontal 90° outlets. Please order splice plates WSV 105.390 separately. The fitting radii are designed so that the cables can be laid in accordance with DIN/VDE 0298 Part 3.

Butt joints must be supported in the immediate vicinity by an appropriate supporting structure.

Used for : wide span cable tray WRL 105... and WRU 105...

Dimensions (approx. dimensions)
 Height H x width W : 105 x 200 mm
 Dimensions outside : 750 mm + W
 Inside rail radius R : 500 mm

Material : steel, hot-dip galvanised acc. to DIN EN ISO 1461
 NIEDAX Model No. : WRBR 105.200 F
 EP Material _____ EP Wage _____
 Unit price/piece

Safety & Environment

REACH Date	25.06.2025
REACH Info	Conformable
RoHS Info	Conformable

Origin & International Trade

Country of origin	DE
Customs tariff number	73089059

Related items

Cover

Model No.	Description
WBRDV 200 F	Cover for elbow 90° for WSL/WRL, width 204 mm, with turning lock, steel, hot dip galvanised DIN EN ISO 1461
WDRS 20 F	Turning bolt with locknut acc. to DIN EN ISO 10511, for WSL/WRL, steel, hot dip galvanised DIN EN ISO 1461, incl. accessories

Connector

Model No.	Description
WSV 105.390 F	Splice plate, 106,5x390 mm, steel, hot dip galvanised DIN EN ISO 1461, incl. accessories