

Elbow 90°

with beaded, round and unperforated side profiles, but with connector perforations

WRBR 105.500 E3

EAN Code: 4013339951116
 Smallest packaging unit: 1 pc.

the photorealistic images are to be considered as reference images

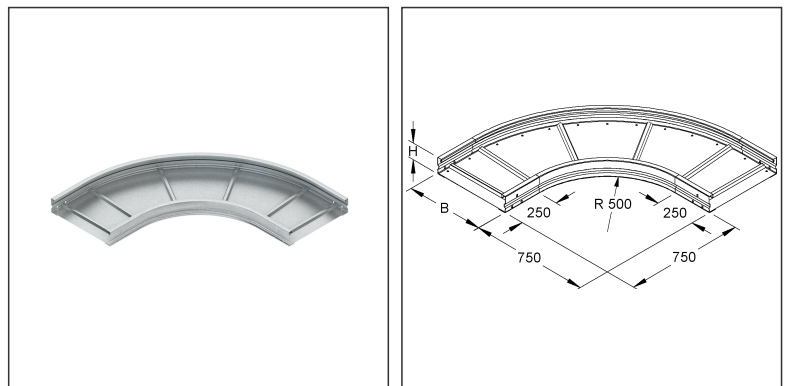

Article Description

Elbow 90° for WRL, 105x500 mm, round, beaded, unperforated, stainless steel, material code: 1.4301, AISI 304

Additional Price Information

Article group	N13
quantity unit	pcs.

Weight

Weight per quantity unit	15 kg / pcs.
Weight in kg per 100	1545 kg / 100pcs.

Technical Datasheet

Long Span Cable Tray

WRBR 105.500 E3

the photorealistic images are to be considered as reference images

Physical Article Dimensions

Height	105.00 mm
Width	1250 mm
Depth/length	1250 mm

Packing Dimension

1 piece = 1 piece		✓ VP1-smallest packaging unit (PU)			
Lenght	1250 mm	Width	1250 mm	Height	105.00 mm
Gross weight	15 kg	Volume	0,164 m ³		
Min. quantity	1.00 pcs.	Max. Quantity	1.00 pcs.		

Tender Text

Elbow 90°, with beaded, round and unperforated side rails, with connector perforation for the connection, for wide span cable trays, dimensionally stable due to the beaded and unperforated bottom riveted over the entire surface, for creating horizontal 90° outlets. Please order splice plate WSV 105.390 separately. The fitting radii are designed so that the cables can be laid in accordance with DIN/VDE 0298 Part 3.

Butt joints must be supported in the immediate vicinity by an appropriate supporting structure.

Used for : wide span cable tray WRL 105... and WRU 105...

Dimensions (approx. dimensions)

Height H x width W : 105 x 500 mm

Dimensions outside : 750 mm + W

Inside rail radius R : 500 mm

Material : stainless steel, material no. 1.4301, AISI 304

NIEDAX Model No. : WRBR 105.500 E3

EP Material_____ EP Wage_____

Unit price/piece

Safety & Environment

REACH Date	25.06.2025
REACH Info	Conformable
RoHS Info	Conformable

Origin & International Trade

Country of origin	DE
Customs tariff number	73089059

Technical Datasheet

Long Span Cable Tray

WRBR 105.500 E3

the photorealistic images are to be considered as reference images

Related items

Cover

Model No.	Description
WBRDV 500 E3	Cover for elbow 90° for WSL/WRL, width 504 mm, with turning lock, stainless steel, material code: 1.4301, AISI 304
WDRS 20 E3	Turning bolt with locknut acc. to DIN EN ISO 10511, for WSL/WRL, stainless steel, material code: 1.4301, AISI 304, incl. accessories

Connector

Model No.	Description
WSV 105.390 E3	Splice plate, 106,5x390 mm, stainless steel, material code: 1.4301, AISI 304, incl. accessories