

Elbow 90°

with beaded, round and unperforated side profiles, but with connector perforations

WRBR 150.200 E3

EAN Code: 4013339951130
 Smallest packaging unit: 1 pc.

the photorealistic images are to be considered as reference images

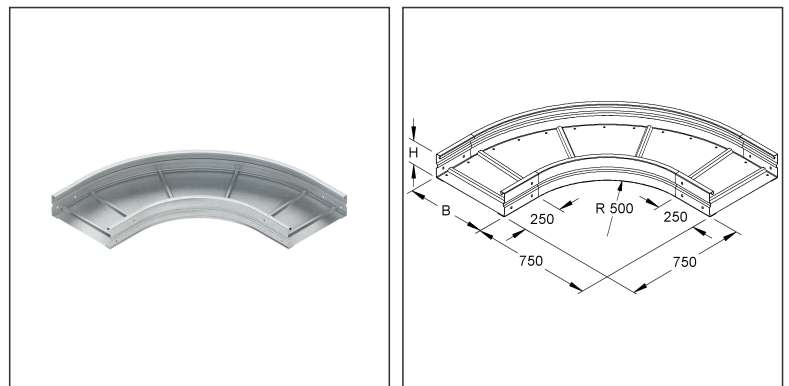

Article Description

Elbow 90° for WRL, 150x200 mm, round, beaded, unperforated, stainless steel, material code: 1.4301, AISI 304

Additional Price Information

Article group	N13
quantity unit	pcs.

Weight

Weight per quantity unit	11 kg / pcs.
Weight in kg per 100	1123 kg / 100pcs.

Technical Datasheet

Long Span Cable Tray

WRBR 150.200 E3

the photorealistic images are to be considered as reference images

Physical Article Dimensions

Height	150.00 mm
Width	950 mm
Depth/length	950 mm

Packing Dimension

1 piece = 1 piece		✓ VP1-smallest packaging unit (PU)			
Lenght	950 mm	Width	950 mm	Height	150.00 mm
Gross weight	11 kg	Volume	0,135 m³		
Min. quantity	1.00 pcs.	Max. Quantity	1.00 pcs.		

Tender Text

Elbow 90°, with beaded, round and unperforated side rails, with connector perforation for the connection, for wide span cable trays, dimensionally stable due to the beaded and unperforated bottom riveted over the entire surface, for creating horizontal 90° outlets. Please order splice plate WSV 150.500 separately. The fitting radii are designed so that the cables can be laid in accordance with DIN/VDE 0298 Part 3.

Butt joints must be supported in the immediate vicinity by an appropriate supporting structure.

Used for : wide span cable tray WRL 150..., WRU 150... and WRLM 150...

Dimensions (approx. dimensions)
 Height H x width W : 150 x 200 mm
 Dimensions outside : 750 mm + W
 Inside rail radius R : 500 mm
 Material : stainless steel, material no. 1.4301, AISI 304
 NIEDAX Model No. : WRBR 150.200 E3
 EP Material_____ EP Wage_____

Unit price/piece

Safety & Environment

REACH Date	25.06.2025
REACH Info	Conformable
RoHS Info	Conformable

Origin & International Trade

Country of origin	DE
Customs tariff number	73089059

Technical Datasheet

Long Span Cable Tray

WRBR 150.200 E3

the photorealistic images are to be considered as reference images

Related items

Cover

Model No.	Description
WBRDV 200 E3	Cover for elbow 90° for WSL/WRL, width 204 mm, with turning lock, stainless steel, material code: 1.4301, AISI 304
WDRS 20 E3	Turning bolt with locknut acc. to DIN EN ISO 10511, for WSL/WRL, stainless steel, material code: 1.4301, AISI 304, incl. accessories

Connector

Model No.	Description
WSV 150.500 E3	Splice plate, 151,5x500 mm, stainless steel, material code: 1.4301, AISI 304, incl. accessories