

### Elbow 90°

with beaded, round and unperforated side profiles, but with connector perforations

### WRBR 200.600 F

EAN Code: 4013339950355

Smallest packaging unit: 1 pc.

the photorealistic images are to be considered as reference images

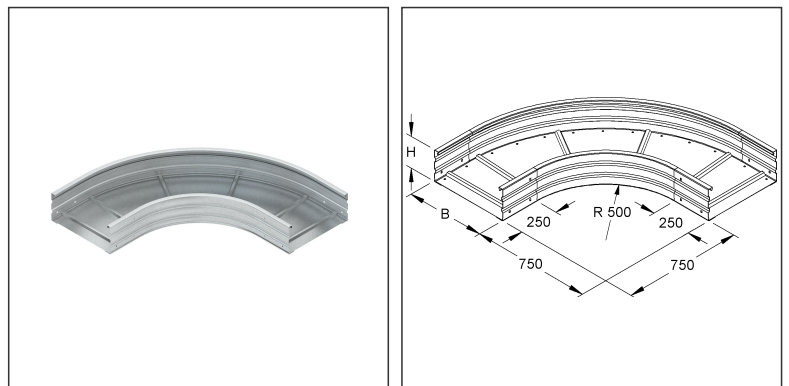

### Article Description

Elbow 90° for WRL, 200x600 mm, round, beaded, unperforated, steel, hot dip galvanised DIN EN ISO 1461

### Additional Price Information

Article group	N13
quantity unit	pcs.

### Weight

Weight per quantity unit	24 kg / pcs.
Weight in kg per 100	2394 kg / 100pcs.

### Physical Article Dimensions

Height	200.00 mm
Width	1350 mm
Depth/length	1350 mm

# Technical Datasheet

## Long Span Cable Tray

WRBR 200.600 F

the photorealistic images are to be considered as reference images

### Packing Dimension

<b>1 piece = 1 piece</b>		✓ VP1-smallest packaging unit ( PU)			
Lenght	1350 mm	Width	1350 mm	Height	200.00 mm
Gross weight	24 kg	Volume	0,364 m³		
Min. quantity	1.00 pcs.	Max. Quantity	1.00 pcs.		

### Tender Text

Elbow 90°, with beaded, round and unperforated side rails, with connector perforation for the connection, for wide span cable trays, dimensionally stable due to the beaded and unperforated bottom riveted over the entire surface, for creating horizontal 90° outlets. Please order splice plates WSV 200.500 separately. The fitting radii are designed so that the cables can be laid in accordance with DIN/VDE 0298 Part 3.

Used for : wide span cable tray WRL 200... and WRU 200...

Dimensions (approx. dimensions)  
 Height H x width W : 200 x 600 mm  
 Dimensions outside : 750 mm + W  
 Inside rail radius R : 500 mm

Material : steel, hot-dip galvanised acc. to DIN EN ISO 1461  
 NIEDAX Model No. : WRBR 200.600 F  
 EP Material\_\_\_\_\_ EP Wage\_\_\_\_\_

Unit price/piece

### Safety & Environment

REACH Date	25.06.2025
REACH Info	Conformable
RoHS Info	Conformable

### Origin & International Trade

Country of origin	DE
Customs tariff number	73089059

### Related items

#### Cover

Model No.	Description
WBRDV 600 F	Cover for elbow 90° for WSL/WRL, width 604 mm, with turning lock, steel, hot dip galvanised DIN EN ISO 1461
WDRS 20 F	Turning bolt with locknut acc. to DIN EN ISO 10511, for WSL/WRL, steel, hot dip galvanised DIN EN ISO 1461, incl. accessories

#### Connector

Model No.	Description
WSV 200.500 F	Splice plate, 201,5x500 mm, steel, hot dip galvanised DIN EN ISO 1461, incl. accessories