

Wide Span Cable Ladder

rung spacing 300 mm, with continuously perforated and beaded side profiles, with riveted, upwardly open C-profile rungs with 16 mm slot width

WSL 150.500 E3

EAN Code: 4013339727063
 Smallest packaging unit: 6 m
 quantity unit: m M

the photorealistic images are to be considered as reference images

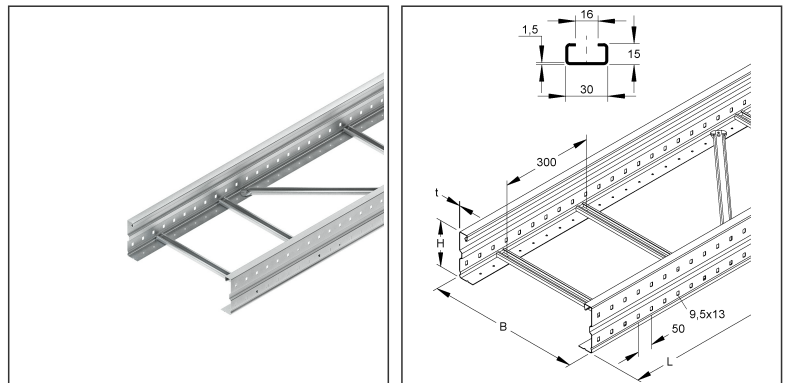

Article Description

Wide span cable ladder, 150x500x6000 mm, t=1,5 mm, perforated, stainless steel, material code: 1.4301, AISI 304

Additional Price Information

Article group	N13
quantity unit	m

Weight

Weight per quantity unit	7,372 kg / m
Weight in kg per 100	737 kg / 100m

Technical Datasheet

Long Span Cable Ladder

WSL 150.500 E3

the photorealistic images are to be considered as reference images

Physical Article Dimensions

Height	150.00 mm
Width	500 mm
Depth/length	6000 mm

Load Specifications

Load diagram: q = evenly distributed cable load (tested acc. to DIN EN IEC 61537)

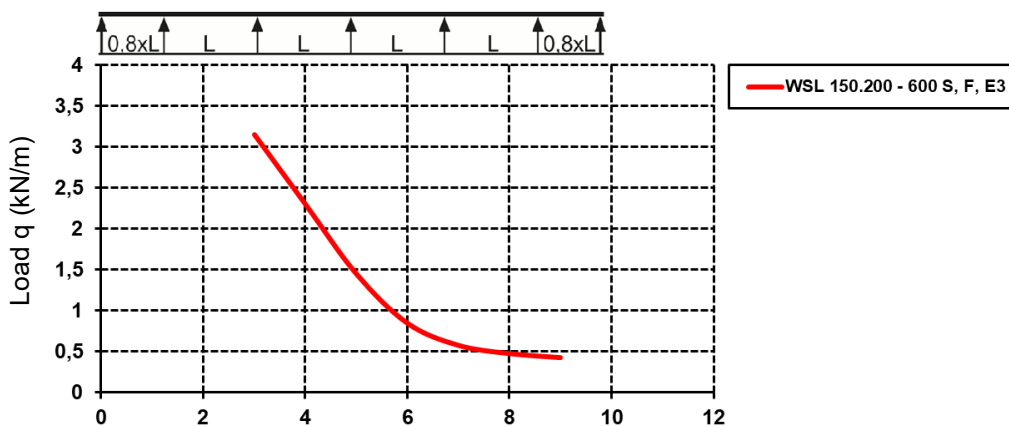

Fixing distance (m)

The load details shown in the diagram are independent of the position of the connectors.

Packing Dimension

6 meters = 1 piece		✓ VP1-smallest packaging unit (PU)	✓ VP1-preferred PU		
Lenght	6000 mm	Width	500 mm	Height	150.00 mm
Gross weight	44 kg	Volume	0,450 m ³		
Min. quantity	6.00 m	Max. Quantity	6.00 m		

Tender Text

Wide span cable ladder, acc. to DIN EN 61537, with continuous perforated and corrugated side rails and rungs riveted in C-profile with 16 mm slot width. Corresponding U-clamps: B... and BK...
 Please order splice plate WSV 150.500 separately.
 Dimensions (approx. dimensions)
 Height H x width W : 150 x 500 mm
 Material thickness : 1.5 mm
 Rung distance : 300 mm
 Side rail perforation : 9.5 x 13 mm
 Hole distance : 50 mm
 Base perforation : Ø 5.4 mm
 Hole distance : 50 mm
 Delivery length : 6000 mm
 Usable cross-section : 65185 mm²
 Material : stainless steel, material no. 1.4301, AISI 304
 NIEDAX Model No. : WSL 150.500 E3
 EP Material _____ EP Wage _____
 Unit price/meter

Technical Datasheet

Long Span Cable Ladder

WSL 150.500 E3

the photorealistic images are to be considered as reference images

Safety & Environment

REACH Date	25.06.2025
REACH Info	Conformable
RoHS Info	Conformable

Origin & International Trade

Country of origin	DE
Customs tariff number	73089059

Related items

Cover

Model No.	Description
WDRS 20 E3	Turning bolt with locknut acc. to DIN EN ISO 10511, for WSL/WRL, stainless steel, material code: 1.4301, AISI 304, incl. accessories
WDV 500 E3	Cover for WSL/WRL, w. joint strip, 504x3000 mm, with turning lock, stainless steel, material code: 1.4301, AISI 304

Barrier strip

Model No.	Description
KLWC 16 E3	Barrier strip fastening clamp, for 16 mm slot width, stainless steel, material code: 1.4301, AISI 304, incl. accessories
RW 110 E3	Barrier strip, 98x3000 mm, t=0,9 mm, stainless steel, material code: 1.4301, AISI 304, incl. accessories

Connector

Model No.	Description
WSV 150.500 E3	Splice plate, 151,5x500 mm, stainless steel, material code: 1.4301, AISI 304, incl. accessories

Accessories

Model No.	Description
WHAS 150 E3	Wide span beam connection piece, height 150 mm, stainless steel, material code: 1.4301, AISI 304, incl. accessories