

**Wide Span Cable Ladder**

rung spacing 300 mm, with continuously perforated and beaded side profiles, with riveted, upwardly open C-profile rungs with 16 mm slot width

**WSL 200.300 F**

EAN Code: 4013339581702  
 Smallest packaging unit: 6 m  
 quantity unit: m M

the photorealistic images are to be considered as reference images

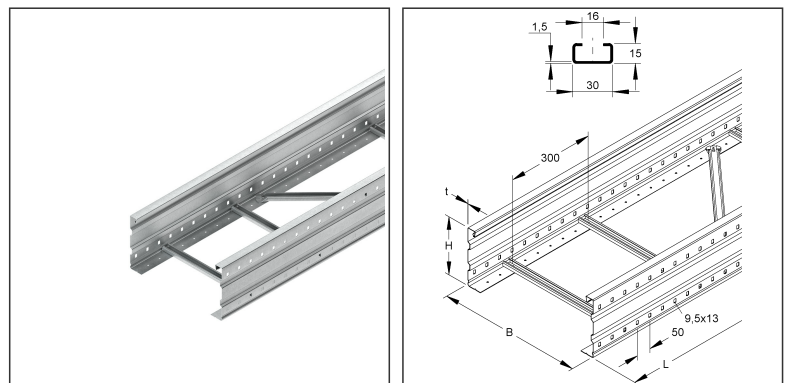

**Article Description**

Wide span cable ladder, 200x300x6000 mm, t=1,5 mm, perforated, steel, hot dip galvanised DIN EN ISO 1461

**Additional Price Information**

Article group	N13
quantity unit	m

**Weight**

Weight per quantity unit	8,987 kg / m
Weight in kg per 100	899 kg / 100m

# Technical Datasheet

## Long Span Cable Ladder

WSL 200.300 F

the photorealistic images are to be considered as reference images

### Physical Article Dimensions

Height	200.00 mm
Width	300 mm
Depth/length	6000 mm

### Load Specifications

Load diagram:  $q$  = evenly distributed cable load (tested acc. to DIN EN IEC 61537)

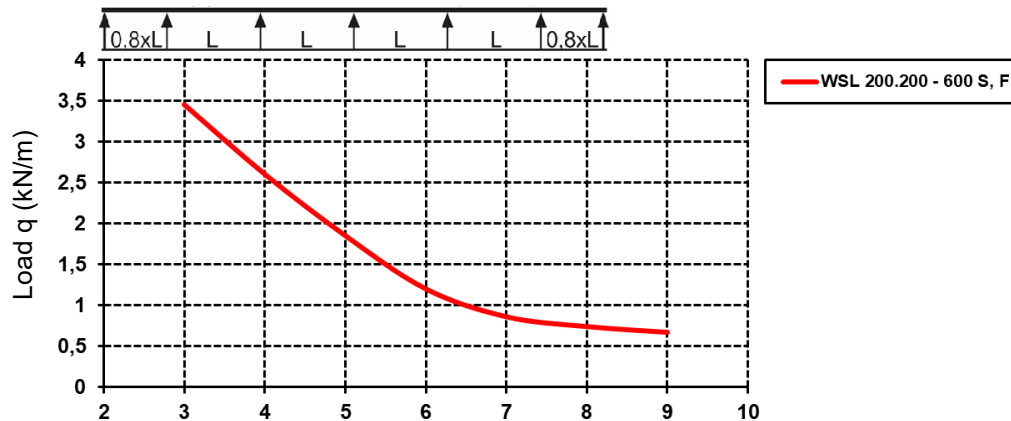

Fixing distance (m)

The load details shown in the diagram are independent of the position of the connectors.

### Packing Dimension

<b>6 meters = 1 piece</b>		✓ VP1-smallest packaging unit ( PU)	✓ VP1-preferred PU		
Lenght	6000 mm	Width	300 mm	Height	200.00 mm
Gross weight	54 kg	Volume	0,360 m <sup>3</sup>		
Min. quantity	6.00 m	Max. Quantity	6.00 m		

### Tender Text

Wide span cable ladder, acc. to DIN EN 61537, with continuous perforated and corrugated side rails and rungs riveted in C-profile with 16 mm slot width.

Corresponding U-clamps: B... and BK...

Please order splice plate WSV 200.500 separately.

Dimensions (approx. dimensions)

Height H x width W : 200 x 300 mm

Material thickness : 1.5 mm

Rung distance : 300 mm

Side rail perforation : 9.5 x 13 mm

Hole distance : 50 mm

Delivery length : 6000 mm

Usable cross-section : 53120 mm<sup>2</sup>

Material : Steel, hot-dip galvanised acc. to DIN EN ISO 1461

NIEDAX Model No. : WSL 200.300 F

EP Material \_\_\_\_\_ EP Wage \_\_\_\_\_

Unit price/meter

# Technical Datasheet

## Long Span Cable Ladder

WSL 200.300 F

the photorealistic images are to be considered as reference images

### Safety & Environment

REACH Date	25.06.2025
REACH Info	Conformable
RoHS Info	Conformable

### Origin & International Trade

Country of origin	DE
Customs tariff number	73089059

### Related items

#### Cover

Model No.	Description
WDRS 20 F	Turning bolt with locknut acc. to DIN EN ISO 10511, for WSL/WRL, steel, hot dip galvanised DIN EN ISO 1461, incl. accessories
WDV 300 F	Cover for WSL/WRL, w. joint strip, 304x3000 mm, with turning lock, steel, hot dip galvanised DIN EN ISO 1461

#### Barrier strip

Model No.	Description
KLWC 16 F	Barrier strip fastening clamp, for 16 mm slot width, steel, hot dip galvanised DIN EN ISO 1461, incl. accessories
RW 110 F	Barrier strip, 98x3000 mm, t=0,9 mm, steel, hot dip galvanised DIN EN ISO 1461, incl. accessories

#### Connector

Model No.	Description
WSV 200.500 F	Splice plate, 201,5x500 mm, steel, hot dip galvanised DIN EN ISO 1461, incl. accessories