

Cable Tray

perforated

RL 60.300

EAN Code: 4013339220205

Smallest packaging unit: 2 x 3 m

quantity unit: m M

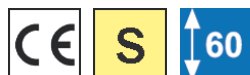

the photorealistic images are to be considered as reference images

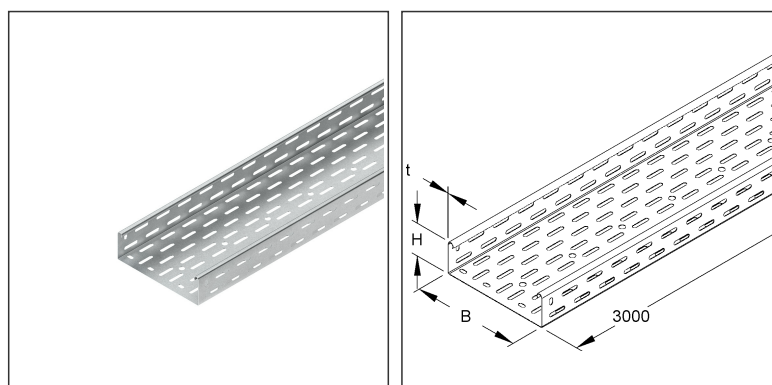
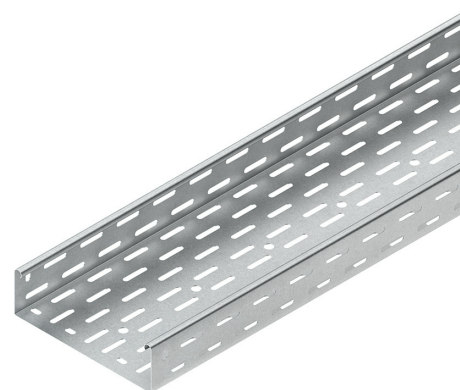

Article Description

Cable tray, 60x300x3000 mm, perforated, steel, pre-galvanised according to DIN EN 10346, incl. accessories

Technical Datasheet

Cable Tray System

RL 60.300

the photorealistic images are to be considered as reference images

Incl. accessories

3 meter = 1 piece		- lowest delivery unit	- preferred delivery unit
Model No.	Description	quantity	
1-FLM 6X12	Mushroom-head bolt M6, similar DIN 603, length 12 mm, steel, electro galvanised according to DIN EN ISO 2081/4042, blue pass	10 pcs.	
1-RV 60.300	Splice plate, single, U-shaped, 49x296 mm, steel, pre-galvanised according to DIN EN 10346, incl. accessories	1 pcs.	
6 meter = 1 bundle		✓ lowest delivery unit	✓ preferred delivery unit
Model No.	Description	quantity	
FLM 6X12	Mushroom-head bolt M6, similar DIN 603, length 12 mm, steel, electro galvanised according to DIN EN ISO 2081/4042, blue pass	20 pcs.	
RV 60.300	Splice plate, single, U-shaped, 49x296 mm, steel, pre-galvanised according to DIN EN 10346, incl. accessories	2 pcs.	
252 meter = 1 rack		- lowest delivery unit	- preferred delivery unit
Model No.	Description	quantity	
FLM 6X12	Mushroom-head bolt M6, similar DIN 603, length 12 mm, steel, electro galvanised according to DIN EN ISO 2081/4042, blue pass	840 pcs.	
RV 60.300	Splice plate, single, U-shaped, 49x296 mm, steel, pre-galvanised according to DIN EN 10346, incl. accessories	84 pcs.	

Additional Price Information

Article group	N13
quantity unit	m

Weight

Weight per quantity unit	3,068 kg / m
Weight in kg per 100	307 kg / 100m

Physical Article Dimensions

Height	60.00 mm
Width	300 mm
Depth/length	3000 mm

Technical Datasheet

Cable Tray System

RL 60.300

the photorealistic images are to be considered as reference images

Load Specifications

Load diagram: q = evenly distributed cable load (tested acc. to DIN EN IEC 61537)

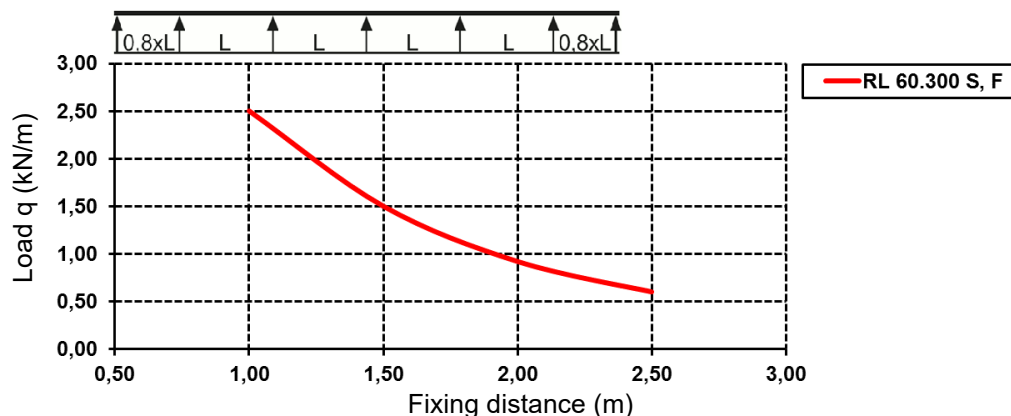

Packing Dimension

6 meters = 1 bundle

✓ VP1-smallest packaging unit (PU) ✓ VP1-preferred PU

Lenght	3000 mm	Width	305 mm	Height	65.00 mm
Gross weight	18 kg	Volume	0,059 m ³		
Min. quantity	6.00 m	Max. Quantity	6.00 m		

252 meters = 1 rack

Lenght	3000 mm	Width	1162 mm	Height	1120 mm
Gross weight	871 kg	Volume	3,904 m ³		
Min. Quantity	252.00 m	Max. Quantity	252.00 m		

Tender Text

Cable tray, acc. to DIN EN 61537, with offset bottom and side perforations, continuous central perforation for suspension with threaded rods M 10/..., including one-piece U-shaped splice plate RV 60... and proportional fastening accessories.

Dimensions (approx. dimensions) H x W : 60 x 300 mm

Material thickness : 1 mm

Centre hole : Ø 11 mm

Delivery length : 3000 mm

Usable cross section : 17800 mm²

Material : steel, pre-galvanised acc. to DIN EN 10346

NIEDAX Model No. : RL 60.300

EP material _____ EP wage _____

Unit price/meter

Safety & Environment

REACH Date	25.06.2025
REACH Info	Conformable
RoHS Info	Conformable

Technical Datasheet

Cable Tray System

RL 60.300

the photorealistic images are to be considered as reference images

Origin & International Trade

Country of origin	DE
Customs tariff number	73089059

Related items

Cover

Model No.	Description
RD 300	Cover for cable tray/-ladder, with joint strip, 302x3000 mm, steel, pre-galvanised according to DIN EN 10346
RDHF 9 E2	Cover clamp, stainless steel, material code: 1.4310
RDHK 60 E2	Cover retaining clamp, height 58 mm, stainless steel, material code: 1.4310
RDRS 9	Turning bolt with locking nut acc. to DIN EN ISO 10511, steel, pre-galvanised according to DIN EN 10346, incl. accessories
RDV 300	Cover for cable tray/-ladder, with joint strip, 302x3000 mm, steel, pre-galvanised according to DIN EN 10346

Barrier strip

Model No.	Description
RW 50	Barrier strip, 47x3000 mm, t=0,75 mm, steel, pre-galvanised according to DIN EN 10346, incl. accessories
RW 60	Barrier strip, 55x3000 mm, t=0,75 mm, steel, pre-galvanised according to DIN EN 10346, incl. accessories