

Elbow 90°, small

made of oval, closed tubular profile bars and welded, downward open, perforated C-profiles

KRCBK 60.425 F

EAN Code: 4013339848867

Smallest packaging unit: 1 pc.

the photorealistic images are to be considered as reference images

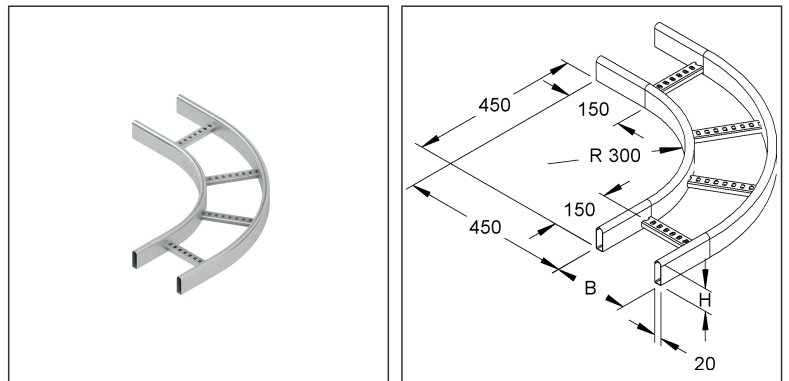

Article Description

Elbow 90°, small, 60x400 mm, with perforated C-profiles, steel, hot dip galvanised DIN EN ISO 1461

Additional Price Information

Article group	N13
quantity unit	pcs.

Weight

Weight per quantity unit	3,902 kg/ pcs.
Weight in kg per 100	390 kg / 100pcs.

Technical Datasheet

Cable Ladder System

KRCBK 60.425 F

the photorealistic images are to be considered as reference images

Physical Article Dimensions

Height	60.00 mm
Width	850 mm
Depth/length	850 mm

Packing Dimension

1 piece = 1 piece		✓ VP1-smallest packaging unit (PU)			
Lenght	850 mm	Width	850 mm	Height	60.00 mm
Gross weight	3,9 kg	Volume	0,043 m ³		
Min. quantity	1.00 pcs.	Max. Quantity	1.00 pcs.		

Tender Text

Elbow 90°, small, side beams made of hollow profiles, with downward open welded rungs made of C-profile with 16 mm slot width and continuous perforation, for creating horizontal 90° elbows. Please order splice plate KRLV 60 F separately. for allround cable ladder : KRC...

Dimensions (approx. dimensions) H x W : 60 x 400 mm Dimensions outside : 450 mm + W

inside beam radius R : 300 mm

Material : Steel, hot-dip galvanised acc. to DIN EN ISO 1461

NIEDAX Model No. : KRCBK 60.425 F

EP Material_____ EP Wage_____

Unit price/piece

Safety & Environment

REACH Date	25.06.2025
REACH Info	Conformable
RoHS Info	Conformable

Origin & International Trade

Country of origin	DE
Customs tariff number	73089059

Related items

Connector

Model No.	Description
KRLV 60 F	Splice plate, steel, hot dip galvanised DIN EN ISO 1461