

Vertical Inside Elbow 90°

vertical, consisting of oval, closed tubular profile rungs and welded in, downward open, perforated C-profiles

KRCS 60.325 F

EAN Code: 4013339849246

Smallest packaging unit: 1 pc.

the photorealistic images are to be considered as reference images

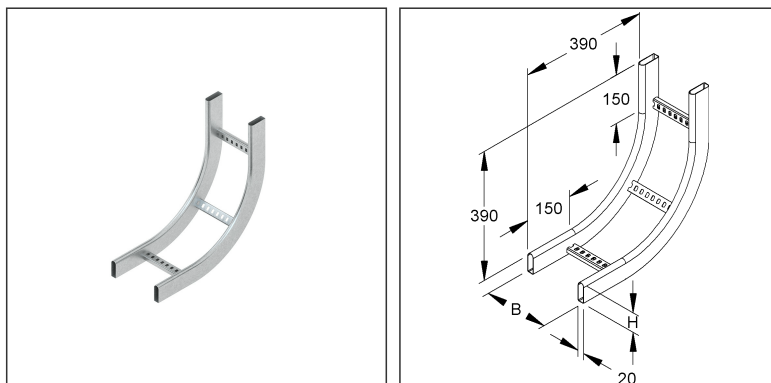

Article Description

Vertical inside elbow 90°, vertical, 60x300 mm, with perforated C-prof, steel, hot dip galvanised DIN EN ISO 1461

Additional Price Information

Article group	N13
quantity unit	pcs.

Weight

Weight per quantity unit	2,335 kg/ pcs.
Weight in kg per 100	233 kg / 100pcs.

Technical Datasheet

Cable Ladder System

KRCS 60.325 F

the photorealistic images are to be considered as reference images

Physical Article Dimensions

Height	450 mm
Width	300 mm
Depth/length	450 mm

Packing Dimension

1 piece = 1 piece		✓ VP1-smallest packaging unit (PU)			
Lenght	450 mm	Width	300 mm	Height	450 mm
Gross weight	2,34 kg	Volume	0,061 m ³		
Min. quantity	1.00 pcs.	Max. Quantity	1.00 pcs.		

Tender Text

Vertical inside elbow 90°, side beams made of hollow sections, with welded-in C-section rungs open at the bottom with 16 mm slot width and continuous perforation, for creating vertical 90° rises. Please order splice plate KRLV 60 F separately. for Allround cable ladder : KRC...

Dimensions (approx. dimensions) H x W : 60 x 300 mm Outer dimensions : 450 mm
Inner beam radius R : 240 mm
Material : Steel, hot-dip galvanised acc. to DIN EN ISO 1461
NIEDAX Model no. : KRCS 60.325 F
EP Material_____ EP Wage_____
Unit price/piece

Safety & Environment

REACH Date	25.06.2025
REACH Info	Conformable
RoHS Info	Conformable

Origin & International Trade

Country of origin	DE
Customs tariff number	73089059

Related items

Connector

Model No.	Description
KRLV 60 F	Splice plate, steel, hot dip galvanised DIN EN ISO 1461