

Profile Clamp

HSK 35 E3

EAN Code: 4013339769001
 Smallest packaging unit: 10 pcs.

the photorealistic images are to be considered as reference images

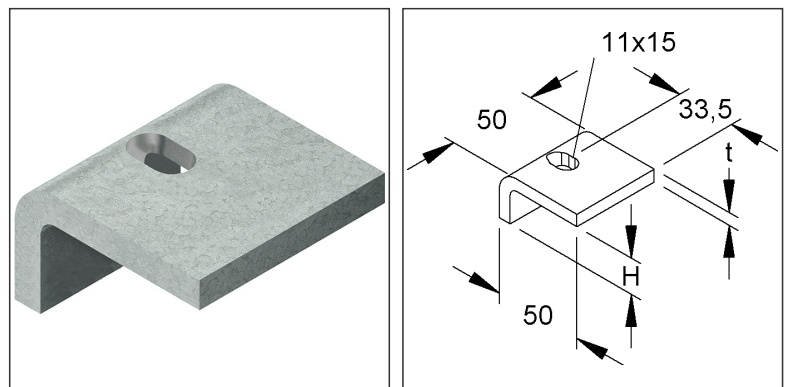

Article Description

Profile clamp, height 35 mm, with fastening holes 11x15 mm, stainless steel, material code: 1.4301, AISI 304

Additional Price Information

Article group	N13
quantity unit	pcs.

Weight

Weight per quantity unit	188 g / pcs.
Weight in kg per 100	19 kg / 100pcs.

Physical Article Dimensions

Height	41.00 mm
Width	50.00 mm
Depth/length	50.00 mm

Technical Datasheet

Fastenings accessories

HSK 35 E3

the photorealistic images are to be considered as reference images

Packing Dimension

10 pieces = 1		✓ VP1-smallest packaging unit (PU)		✓ VP1-preferred PU	
Lenght	138.00 mm	Width	96.00 mm	Height	71.00 mm
Gross weight	1,94 kg	Volume	0,001 m ³		
Min. quantity	10.00 pcs.	Max. Quantity	10.00 pcs.		
1260 pieces = 1					
Lenght	750 mm	Width	750 mm	Height	730 mm
Gross weight	284 kg	Volume	0,411 m ³		
Min. Quantity	1.260.00 pcs.	Max. Quantity	1.260.00 pcs.		

Tender Text

<p>Profile clamp, for clamping connection to steel beam flanges. Dimensions (approx. dimensions) Clamping height H : 35 mm Width W : 50 mm Length L : 50 mm Material thickness t : 6 mm Fastening holes : 11 x 15 mm for beam flange thickness : 30 - 34 mm Material : Stainless steel, Material No. 1.4301, AISI 304 NIEDAX Model No. : HSK 35 E3 EP Material _____ EP Wage _____ Unit price/piece</p>
--

Safety & Environment

REACH Date	25.06.2025
REACH Info	Conformable
RoHS Info	Conformable

Origin & International Trade

Country of origin	DE
Customs tariff number	73089059