

Profile Clamp

heavy design

HSKS 10

EAN Code: 4013339196425
 Smallest packaging unit: 25 pcs.

the photorealistic images are to be considered as reference images

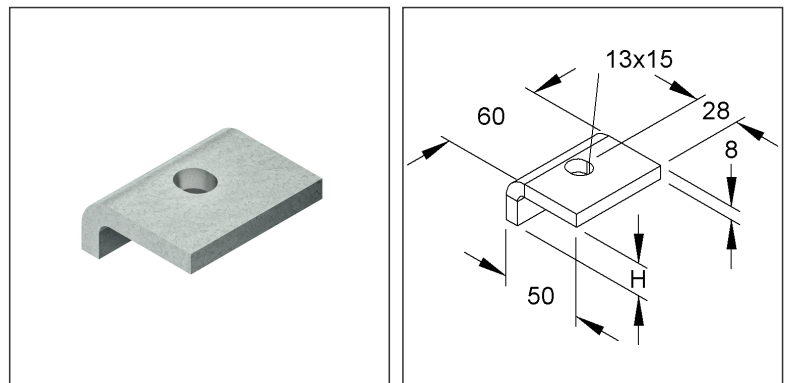

Article Description

Profile clamp, heavy, height 10 mm, with fastening holes 13x15 mm, steel, hot dip galvanised DIN EN ISO 1461

Additional Price Information

Article group	N13
quantity unit	pcs.

Weight

Weight per quantity unit	222 g / pcs.
Weight in kg per 100	22 kg / 100pcs.

Technical Datasheet

Fastenings accessories

HSKS 10

the photorealistic images are to be considered as reference images

Physical Article Dimensions

Height	18.00 mm
Width	50.00 mm
Depth/length	60.00 mm

Packing Dimension

25 pieces = 1 carton		✓ VP1-smallest packaging unit (PU)	✓ VP1-preferred PU		
Lenght	210 mm	Width	150.00 mm	Height	100.00 mm
Gross weight	5,74 kg	Volume	0,003 m ³		
Min. quantity	25.00 pcs.	Max. Quantity	25.00 pcs.		

4050 pieces = 1 pallet					
Lenght	1200 mm	Width	800 mm	Height	1000 mm
Gross weight	944 kg	Volume	0,960 m ³		
Min. Quantity	4.050.00 pcs.	Max. Quantity	4.050.00 pcs.		

Tender Text

Profile clamp, heavy duty, for clamping connection to steel support flanges.
Dimensions (approx. dimensions)
Clamping height H : 10 mm
Width W : 60 mm
Length L : 50 mm
Material thickness t : 8 mm
Fastening holes : 13 x 15 mm
for beam flange thickness : 5 - 9 mm
Material : Steel, hot-dip galvanised acc. to DIN EN ISO 1461
NIEDAX Model No. : HSKS 10
EP Material _____ EP Wage _____
Unit price/piece

Safety & Environment

REACH Date	25.06.2025
REACH Info	Conformable
RoHS Info	Conformable

Origin & International Trade

Country of origin	DE
Customs tariff number	73089059